

For evaluation only; not FCC approved for resale.

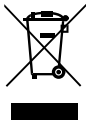

# PMP22339C

GND VOUT

DANGER HIGH VOLTAGE



TP5

TP4

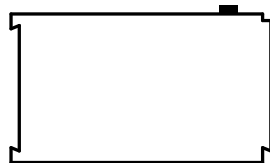

J2

C101 +

C12 +

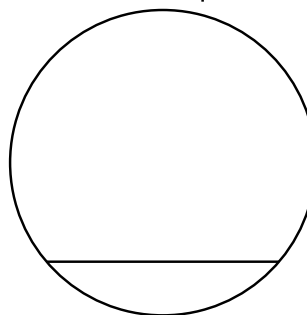
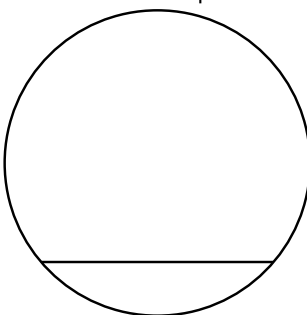

D1

H1

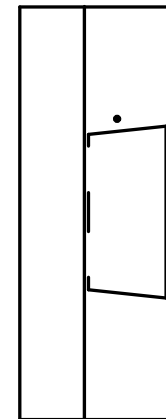

H2

TP7

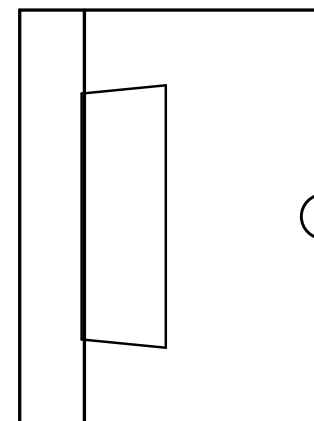

Q1

12V GND

J4

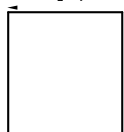

C25

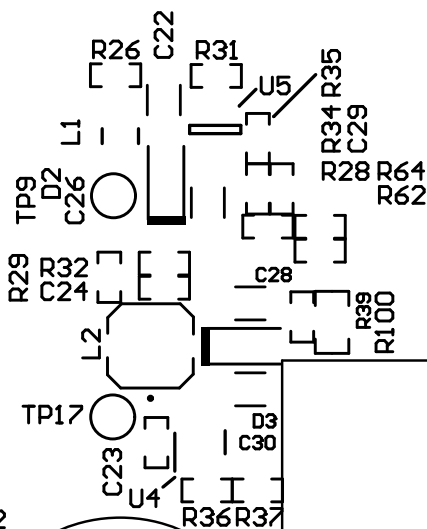

TP9

TP17

C100

C2

T1

.

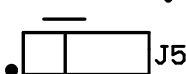

J5

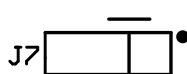

J7

VIN GND

J1



TP2

TP3

DANGER HIGH VOLTAGE



R49  
VSET



J6  
CHG  
VSET  
DAC



TP10  
VREF1



TP11  
VREF2



TP12  
GND



TP16  
VREF3



TP1  
MB  
CHG  
ISNS



J8  
CHG  
ISET  
DAC



R55  
ISET



TP13  
Loop1



TP14  
Loop2



TP15  
GND



J3  
/ENABLE



TP8  
GND

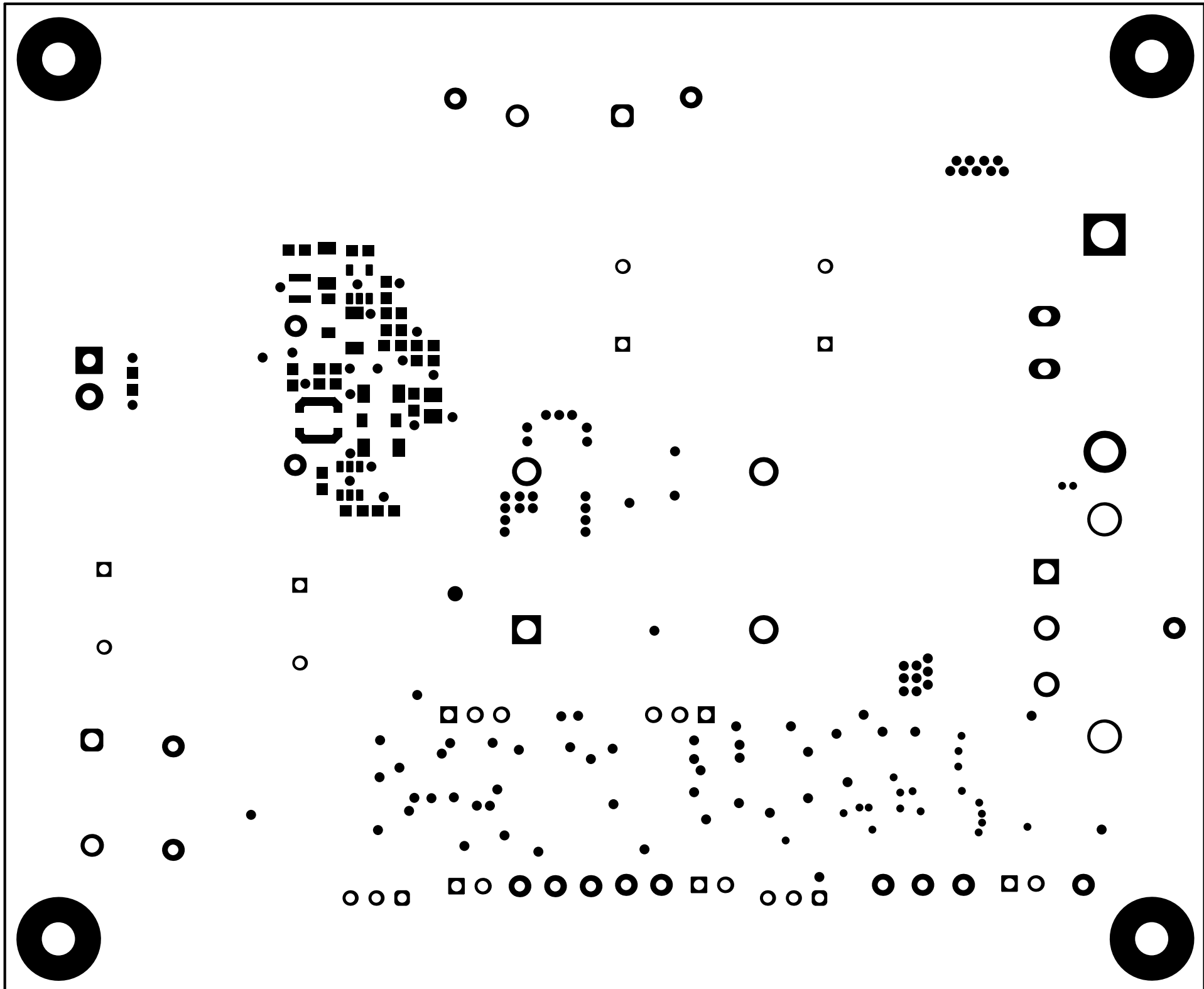

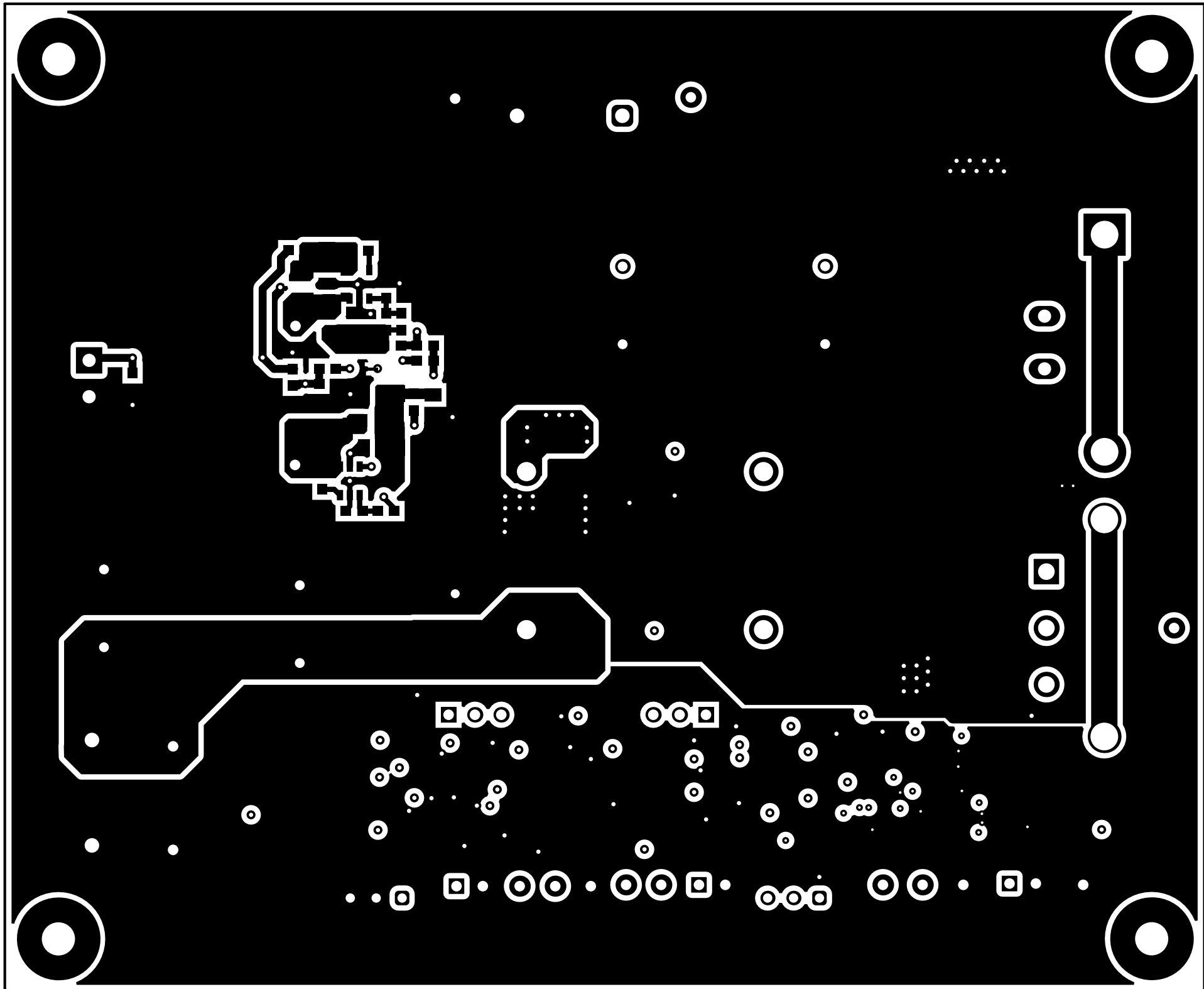

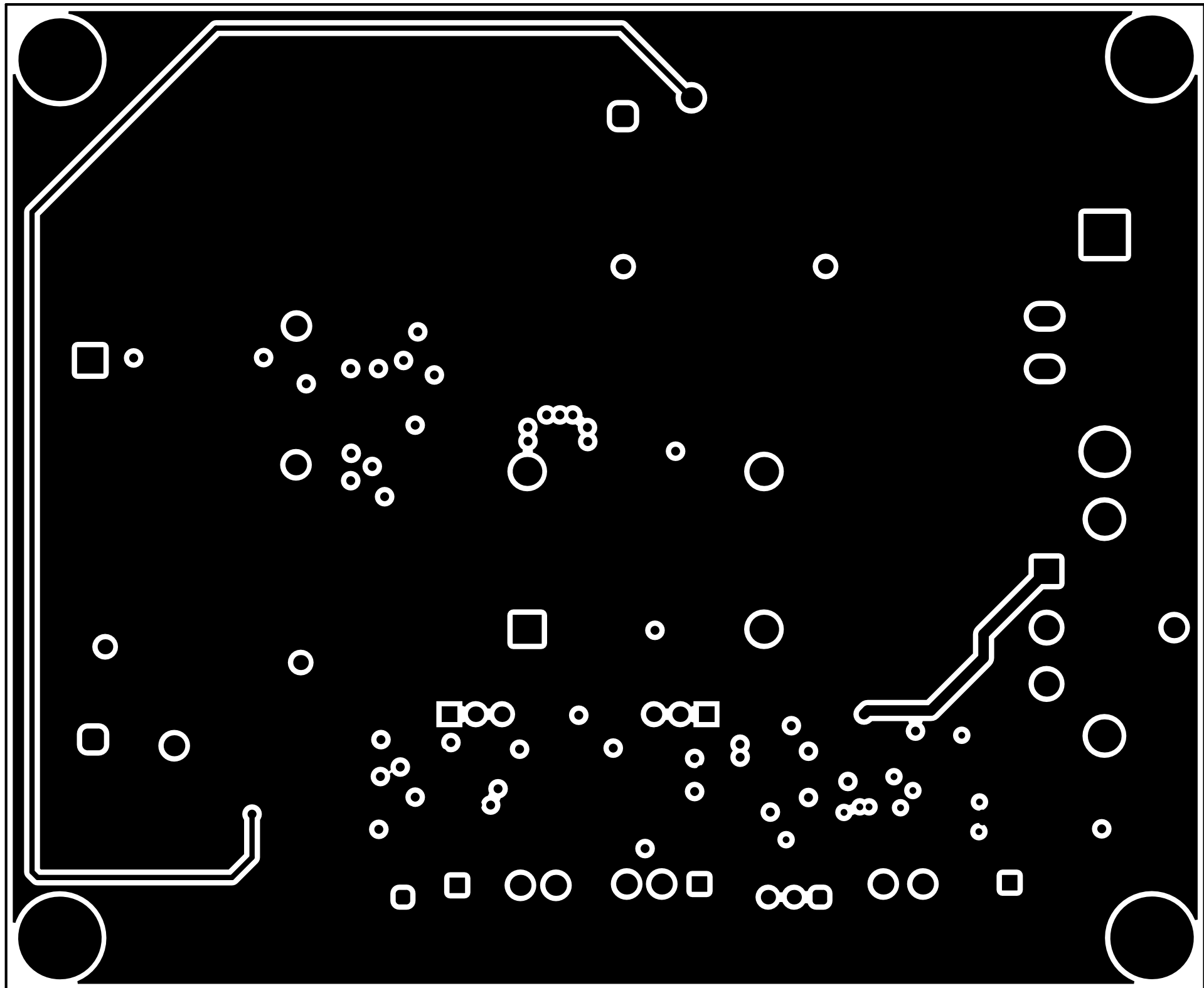

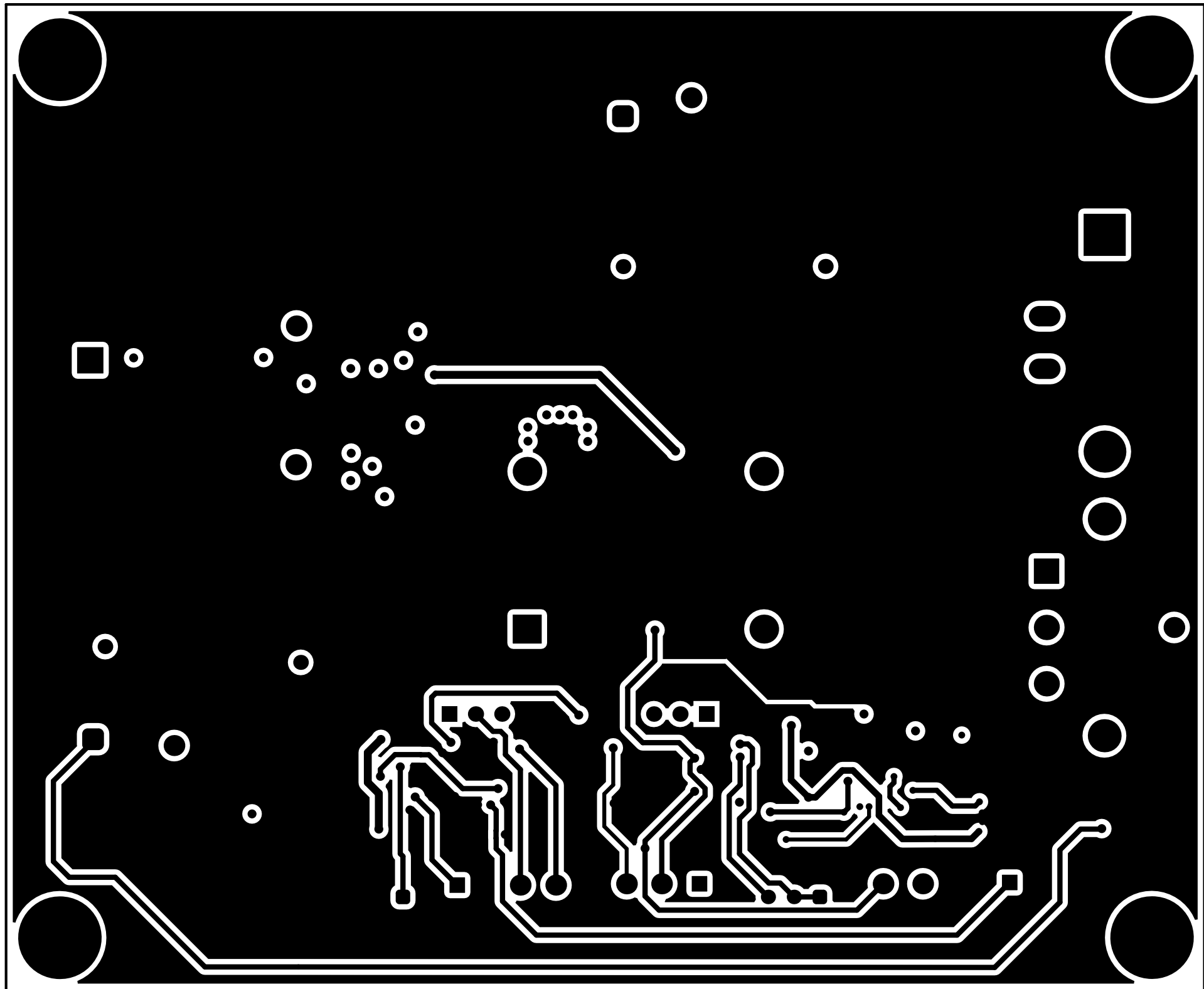

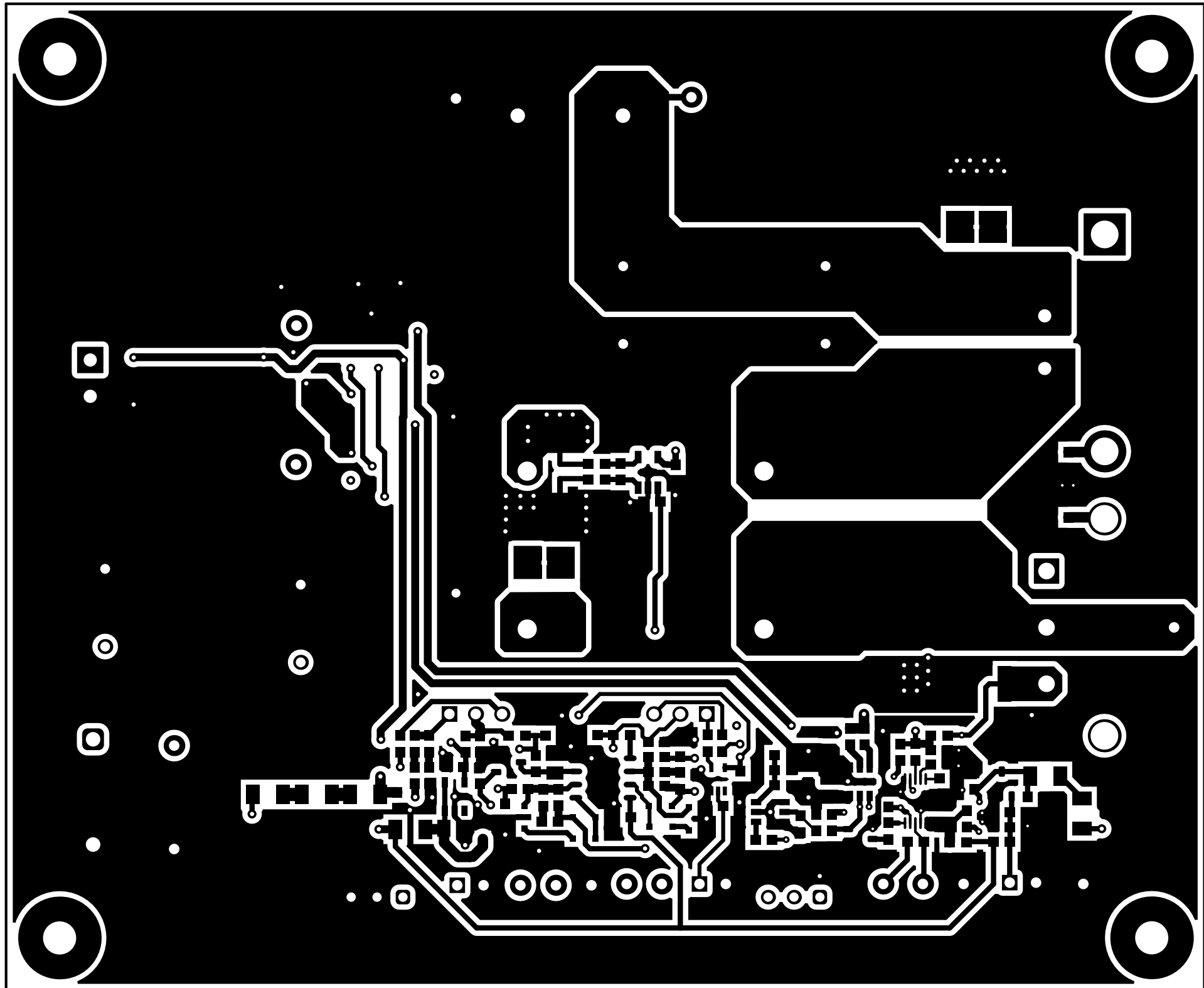

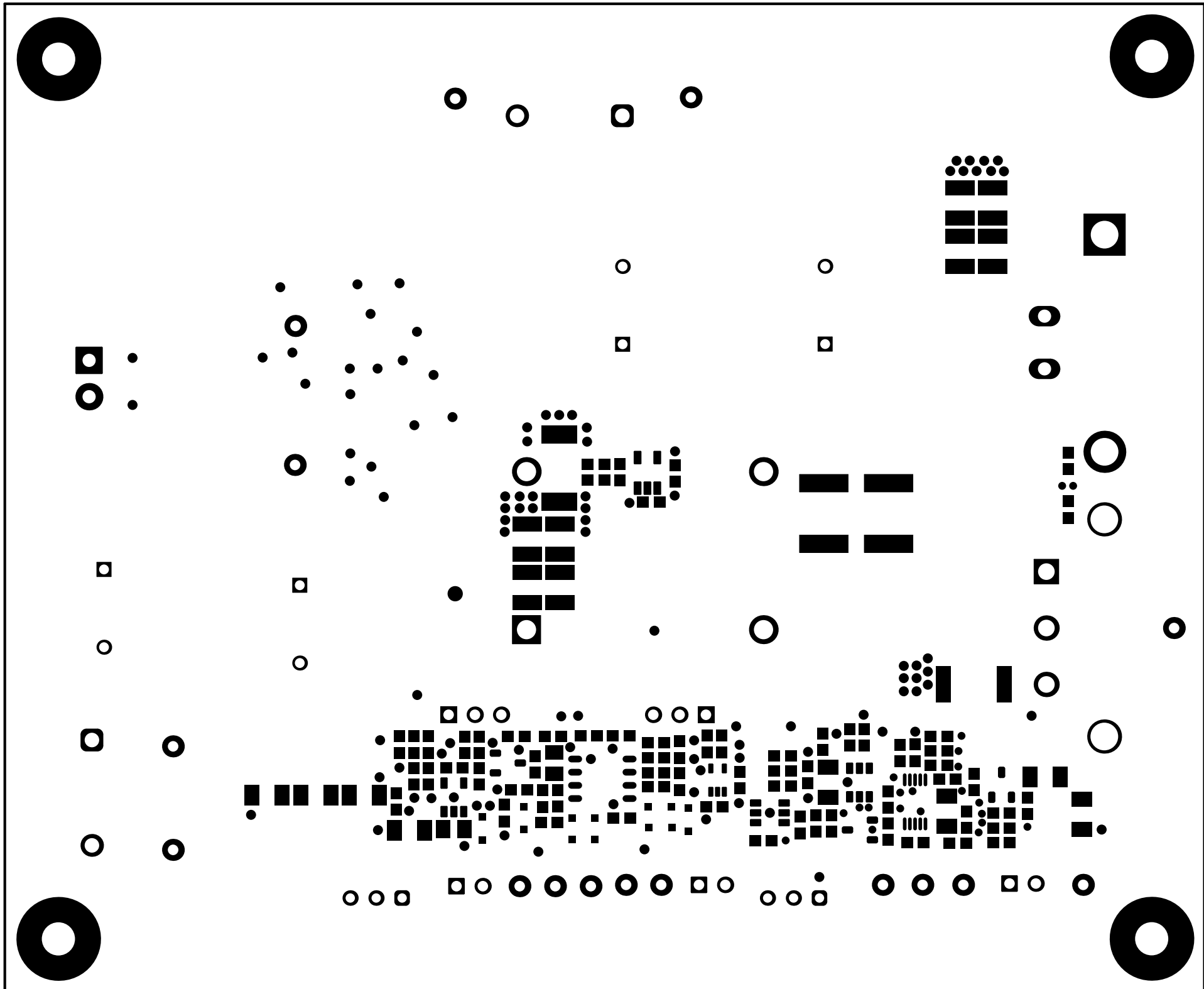

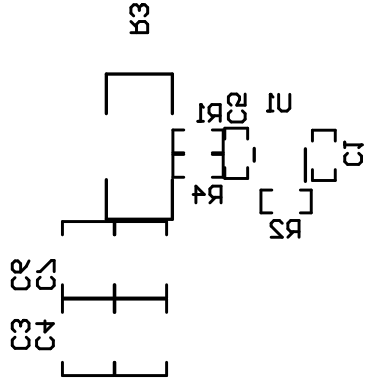
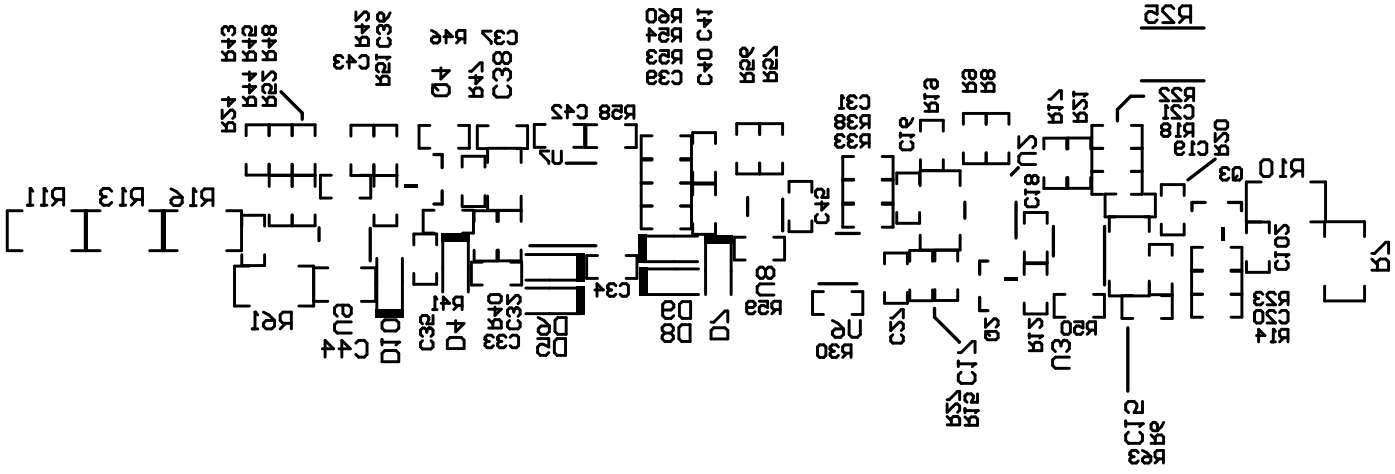

C8

C11

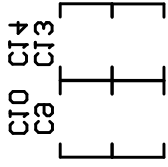

R101 R105  
[ ] [ ] [ ] [ ]



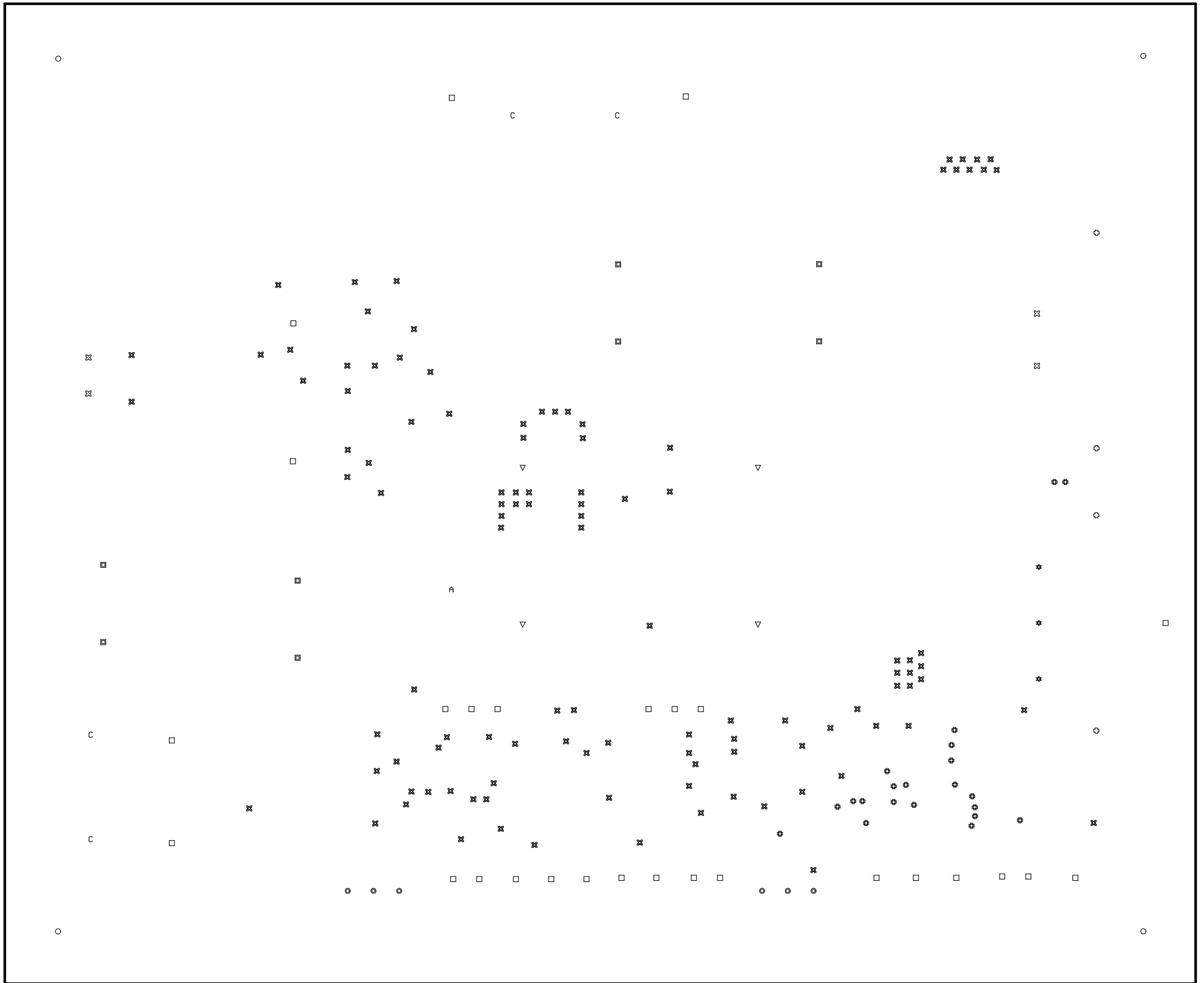

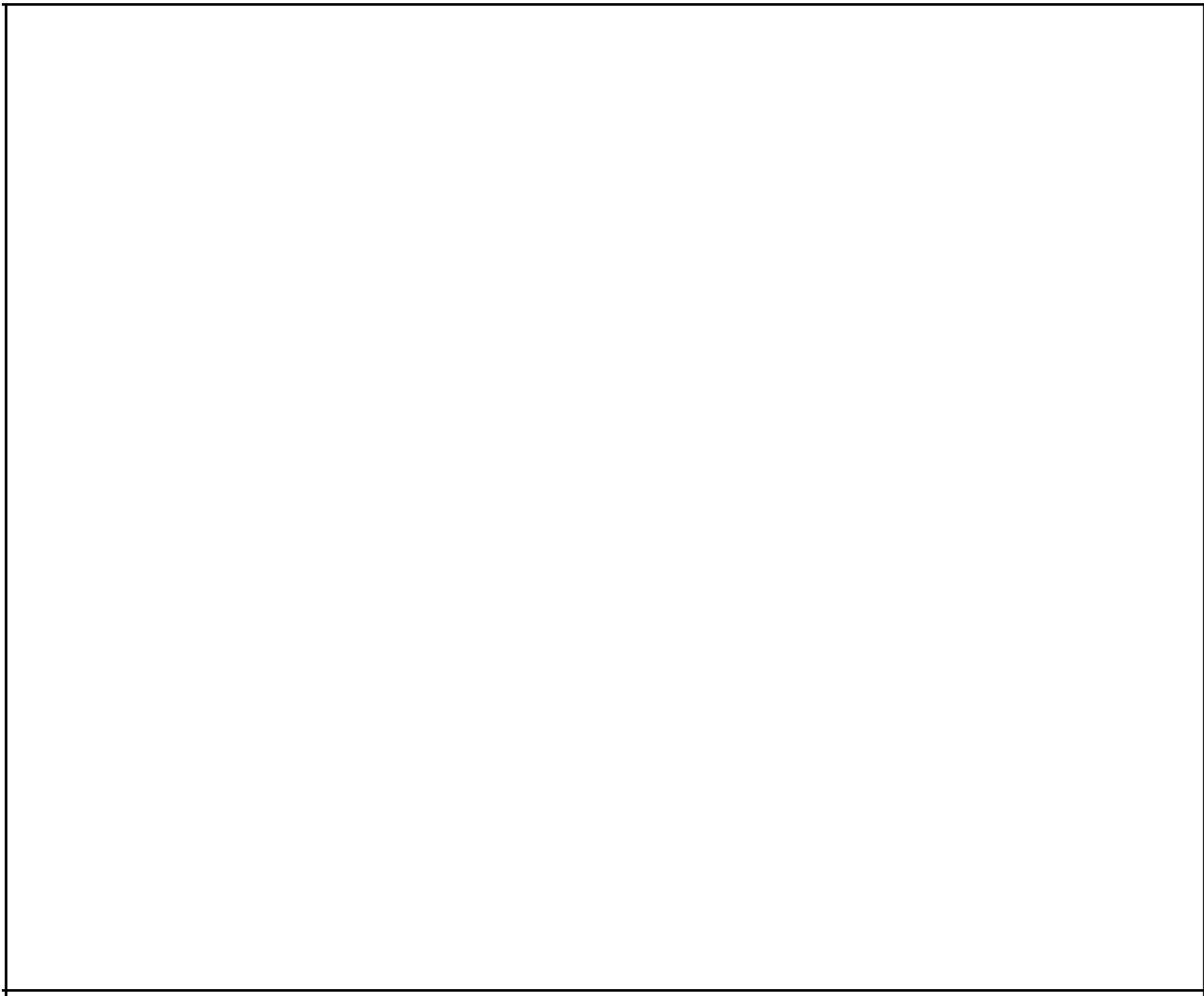

## IMPORTANT NOTICE AND DISCLAIMER

TI PROVIDES TECHNICAL AND RELIABILITY DATA (INCLUDING DATASHEETS), DESIGN RESOURCES (INCLUDING REFERENCE DESIGNS), APPLICATION OR OTHER DESIGN ADVICE, WEB TOOLS, SAFETY INFORMATION, AND OTHER RESOURCES "AS IS" AND WITH ALL FAULTS, AND DISCLAIMS ALL WARRANTIES, EXPRESS AND IMPLIED, INCLUDING WITHOUT LIMITATION ANY IMPLIED WARRANTIES OF MERCHANTABILITY, FITNESS FOR A PARTICULAR PURPOSE OR NON-INFRINGEMENT OF THIRD PARTY INTELLECTUAL PROPERTY RIGHTS.

These resources are intended for skilled developers designing with TI products. You are solely responsible for (1) selecting the appropriate TI products for your application, (2) designing, validating and testing your application, and (3) ensuring your application meets applicable standards, and any other safety, security, or other requirements. These resources are subject to change without notice. TI grants you permission to use these resources only for development of an application that uses the TI products described in the resource. Other reproduction and display of these resources is prohibited. No license is granted to any other TI intellectual property right or to any third party intellectual property right. TI disclaims responsibility for, and you will fully indemnify TI and its representatives against, any claims, damages, costs, losses, and liabilities arising out of your use of these resources.

TI's products are provided subject to TI's Terms of Sale (<https://www.ti.com/legal/termsofsale.html>) or other applicable terms available either on [ti.com](https://www.ti.com) or provided in conjunction with such TI products. TI's provision of these resources does not expand or otherwise alter TI's applicable warranties or warranty disclaimers for TI products.

Mailing Address: Texas Instruments, Post Office Box 655303, Dallas, Texas 75265  
Copyright © 2021, Texas Instruments Incorporated