

Ultrasonic sensing technology for flow metering



Srinivas Lingam
Systems and Applications Engineer
MSP430™ Microcontrollers
Texas Instruments

Introduction

Ultrasonic sensing uses the time of flight (TOF) of an ultrasonic wave and its dependency on the flow rate of the medium to measure and calculate volume flow, using the difference in the propagation time of the ultrasonic wave when transmitted into and against the direction of the flow. This technology is outstanding at measuring volume flow rates across a wide range and works with fluids like water and oil as well as gases like air and methane.

TOF-based ultrasonic meters measure flow rates based on the difference in propagation time of ultrasonic signals in the upstream and downstream directions. The ultrasound wave travels faster when traveling in the direction of the flow and slower when against the flow. This technology works whether the transducer pairs are located inside of a pipe or clamped to the outside of a pipe. This approach does require a direct path between the two transducers, requiring careful mechanical construction of the flow tube where the transducers are housed. The technology does not work in the presence of air bubbles, which lead to significant attenuation of the ultrasound signal. Because the propagation velocity of an ultrasound wave varies between a single fluid or a composition of multiple fluids in a mixture, TOF-based ultrasonic technology can also be used for material composition analysis.

Ultrasonic flow meter configurations

TOF-based ultrasonic flow meters have two types of construction: in-line or clamp-on. In-line are intrusive flow meters where transducers are installed inside the flow tubes and make contact with the liquid; clamp-on flow meters are non-intrusive by installing the transducers on the surface of the pipe and sense the sound wave traveling through the pipe.

In-line flow meters can be diagonal and give the transducers a direct line of sight, as shown in **Figure 1**. Or they can be reflective, where the sound wave from a transmitting transducer reaches a second transducer only after reflection from a material on the surface of the pipe, as shown in **Figure 2** on the following page. Some industrial flow meters with large diameter flow tubes use two pairs of

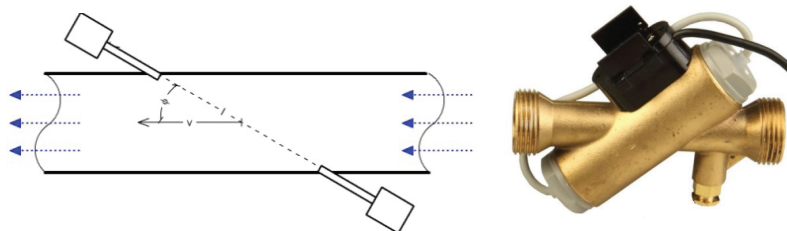

Figure 1. In-line and diagonal transducer placement.

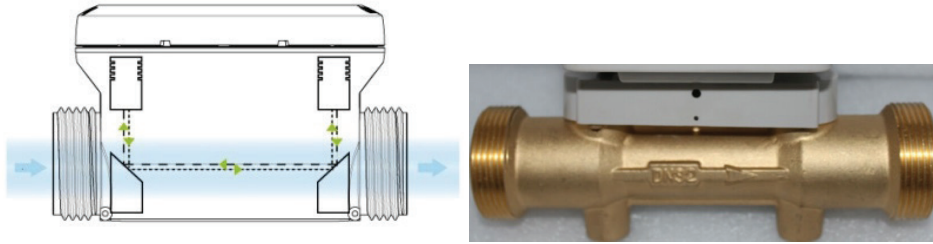

Figure 2. In-line and reflective transducer placement.

transducers for improved performance, accommodating the larger attenuation that will occur with larger pipe diameters, as shown in **Figure 3**.

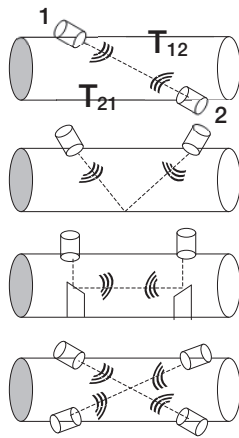

Figure 3. Various configurations of in-line placement of transducer pairs.

Figure 4 shows a clamp-on transducer placement that encounters additional signal attenuation because the ultrasonic wave needs to traverse through the pipe material.

One of the key challenges associated with ultrasonic flow meters is maintaining

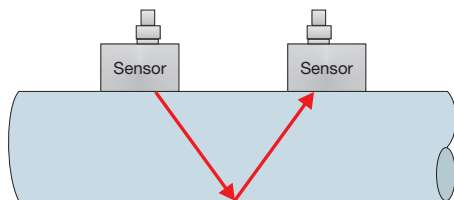

Figure 4. Clamp-on transducer placement.

accuracy over a wide range of flow rates, from a few liters per hour (lph) to tens of thousands lph. Another challenge is maintaining flow-rate accuracy over fluid temperatures that can range from 0°C to 85°C, depending on the application. Because the velocity of an ultrasonic wave in fluid varies with the fluid's temperature, the difference in propagation time to take flow-rate measurements will introduce errors when the fluid temperature changes. For example, the velocity of sound in water varies between 1,420 mps to 1,540 mps and is neither linear nor asymptotic in nature, as shown in **Figure 5** on the following page. In general, this can lead to errors in flow-rate estimation of more than 5 percent if you do not account for temperature. For improved accuracy, the system will require a temperature sensor.

It is possible, however, to construct an alternate approach that takes measurements independent of temperature. This method entails obtaining the volume flow rate of a fluid using the absolute time of upstream and downstream propagation or TOF, in addition to the difference of the propagation.



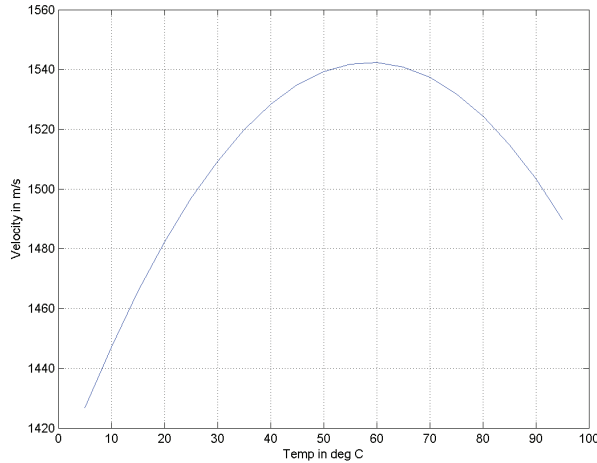

Figure 5. The velocity of ultrasound in water as a function of water temperature.

Analog-to-digital converter (ADC)-based processing advantages

Several different approaches can be used to obtain the difference in the upstream and downstream TOF. One approach uses the zero crossing of a time-to-digital converted (TDC) signal. Another correlates the signal obtained after analog-to-digital conversion (ADC) to the signal received at the transducer.

The TDC technique uses an initial threshold crossing for the signal followed by zero crossings of the signal, as shown in **Figure 6**.

In the correlation-based ADC technique, the whole waveform is captured and stored for the signal received at the transducer for both the upstream and downstream measurements. Performing post-processing on the waveform determines the differential TOF.

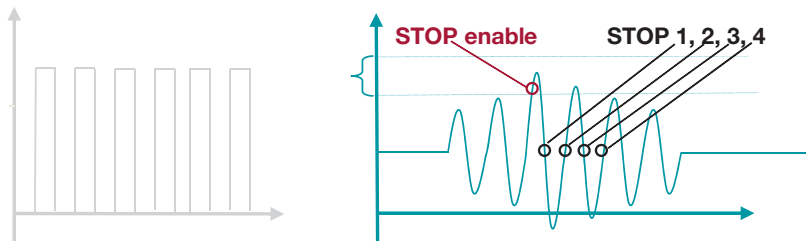

Figure 6. Zero-crossing-based TDC technique.

The ADC-based approach has these inherent advantages over the TDC approach:

- Performance.** The correlation also provides low-pass filtering to suppress noise. This is implemented efficiently on the low-energy accelerator in the Texas Instruments [MSP430FR6047 MCU](#). The correlation approach results in a benefit of ~3–4× noise lower standard deviation. The correlation filter also suppresses interference like line noise.
- Robustness to signal-amplitude variations.** The algorithm based on the correlation technique, is insensitive to the received signal amplitude, transducer-to-transducer variation and temperature variation. Signal amplitude variation is observed frequently in high flow rates. Robustness is a significant advantage when transducer performance degrades over time, since some applications deploy flow meters for more than 10 years.
- ADC-based processing obtains the signal envelope naturally.** The availability of the signal amplitude information enables tuning to the transducer frequencies. Also, you can use slow variations in the envelope across time to detect transducer aging. The ADC-based approach is also amenable to automatic gain control (AGC), which can boost the received signal if the transducer gain reduces over time (again, due to aging). As the correlation-based algorithm receives the amplified signal that

maintains the output signal level, even with transducer aging, the system performance does not degrade over time.

Figure 7 on the following page is a functional block diagram of the correlation-based ADC approach,

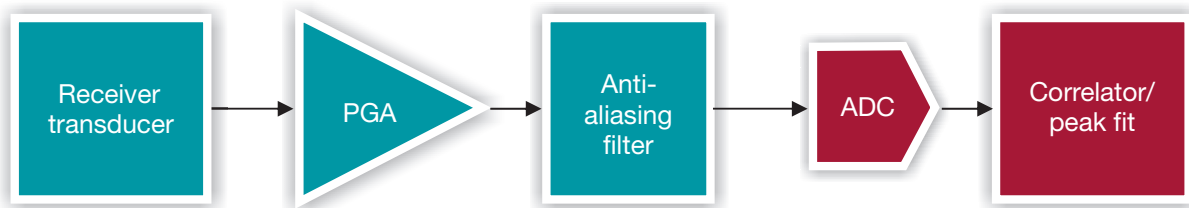

Figure 7. Correlation-based differential TOF estimator.

which requires the use of an ADC that oversamples the received signal.

Absolute TOF measurement

An absolute TOF measurement eliminates the need for a temperature sensor and the need to compute the velocity of sound in water. There are several approaches to calculating absolute TOF accurately. One approach computes the envelope of the received signal and the envelope crossing at a specified ratio to the maximum of the signal.

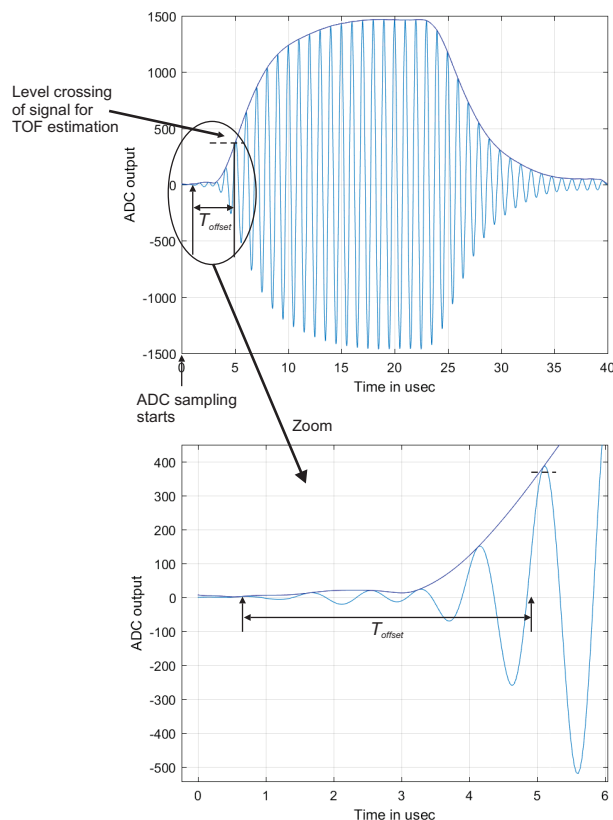

Figure 8. ADC captured waveform and envelope for absolute TOF calculation, with a zoomed-in version of the initial waveform cycles in the bottom panel.

The absolute TOF will be a constant offset from this threshold crossing of the envelope, as illustrated in Figure 8.

MSP430FR6047 MCU ultrasonic-sensing module

The functional blocks that help achieve high performance for an ultrasonic flow meter application are part of an analog front end (AFE) called the ultrasonic-sensing solution (USS) IP block, which operates independently of the MSP430™ MCU's central processing unit (CPU). Figure 9 on the following page shows a conceptual block diagram. The ultrasonic-sensing module includes a universal USS power supply (UUPS), a power sequencer (PSQ), a programmable pulse generator (PPG), a physical driver and impedance matching network (PHY), a programmable gain amplifier (PGA), a high-speed phase-locked loop (HSPLL), a sigma-delta high-speed (SDHS) ADC, and an acquisition sequencer (ASQ).

The ultrasonic-sensing module has its own power domain and can be powered ON and OFF independent of the other blocks on the MSP430FR6047 MCU. You can also reset it without affecting any of the other modules on the device.

The impedance matching in the ultrasonic-sensing module is critical to obtain a very low drift in the delta time-of-flight measurement over time and any variation in water temperature. This also leads to the ability to detect very low flow rates.

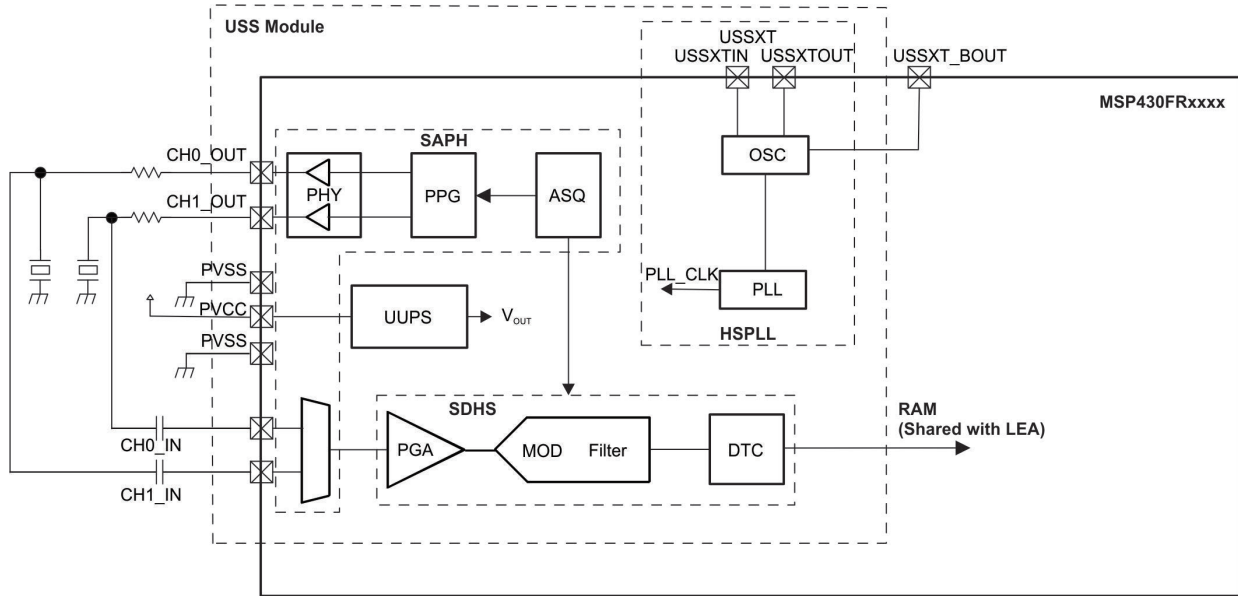

Figure 9. Ultrasonic-sensing solution functional block diagram.

Conclusion

TI's latest ADC-based ultrasonic sensing technology enables smart water flow meters to deliver high precision and accuracy. This performance can be achieved while maintaining low current consumption through the integration of the ultrasonic-sensing module and [low-energy accelerator](#) in the MSP430FR6047 MCU.

Important Notice: The products and services of Texas Instruments Incorporated and its subsidiaries described herein are sold subject to TI's standard terms and conditions of sale. Customers are advised to obtain the most current and complete information about TI products and services before placing orders. TI assumes no liability for applications assistance, customer's applications or product designs, software performance, or infringement of patents. The publication of information regarding any other company's products or services does not constitute TI's approval, warranty or endorsement thereof.

The platform bar and MSP430 are trademarks of Texas Instruments. All other trademarks are the property of their respective owners.

IMPORTANT NOTICE AND DISCLAIMER

TI PROVIDES TECHNICAL AND RELIABILITY DATA (INCLUDING DATASHEETS), DESIGN RESOURCES (INCLUDING REFERENCE DESIGNS), APPLICATION OR OTHER DESIGN ADVICE, WEB TOOLS, SAFETY INFORMATION, AND OTHER RESOURCES "AS IS" AND WITH ALL FAULTS, AND DISCLAIMS ALL WARRANTIES, EXPRESS AND IMPLIED, INCLUDING WITHOUT LIMITATION ANY IMPLIED WARRANTIES OF MERCHANTABILITY, FITNESS FOR A PARTICULAR PURPOSE OR NON-INFRINGEMENT OF THIRD PARTY INTELLECTUAL PROPERTY RIGHTS.

These resources are intended for skilled developers designing with TI products. You are solely responsible for (1) selecting the appropriate TI products for your application, (2) designing, validating and testing your application, and (3) ensuring your application meets applicable standards, and any other safety, security, or other requirements. These resources are subject to change without notice. TI grants you permission to use these resources only for development of an application that uses the TI products described in the resource. Other reproduction and display of these resources is prohibited. No license is granted to any other TI intellectual property right or to any third party intellectual property right. TI disclaims responsibility for, and you will fully indemnify TI and its representatives against, any claims, damages, costs, losses, and liabilities arising out of your use of these resources.

TI's products are provided subject to TI's Terms of Sale (www.ti.com/legal/termsofsale.html) or other applicable terms available either on ti.com or provided in conjunction with such TI products. TI's provision of these resources does not expand or otherwise alter TI's applicable warranties or warranty disclaimers for TI products.

Mailing Address: Texas Instruments, Post Office Box 655303, Dallas, Texas 75265
Copyright © 2019, Texas Instruments Incorporated