



Pedrhom Nafisi

ABSTRACT

With radar emerging as a new technology for the safety application space, safety standards were made in order to define what it takes for a radar-based safety system to be considered safe. The newly created IEC TS 61496-5:2023 has set performance requirements that a radar protective device within a safety system must meet in order to be certifiably safe. The requirements given are in context to the detection of an adult human being present in an industrial manufacturing environment that contains areas that must be monitored for safety. Functional tests were created that obstruct the sensor in different ways while attempting to detect an actual person or a corner reflector rated to the 99th percentile of a human being. This document covers what functional tests are listed within IEC TS 61496-5:2023 in order to verify radar performance for an adult human, the many terms their definitions used throughout the standard, and how the IWR6843 and IWR6843AOP mmWave Radar sensors passes the requirements defined.

Table of Contents

1 Introduction	2
2 TI mmWave Radar and Functional Safety	2
3 IEC 61496-5 Functional Tests	3
3.1 Testing With Static Residual Movement.....	3
3.2 Detection Zone.....	4
3.3 Tolerance Zone.....	5
4 Results	6
4.1 Response Time.....	6
4.2 Position Accuracy.....	6
4.3 Coexistence of Several RPDs.....	7
4.4 Interference by Object Outside the Detection Zone.....	8
4.5 Interference by Object Inside the Detection Zone.....	9
4.6 Manual Interference.....	10
5 Environmental Tests	11
6 Covered by Other Tests	11
7 Test Setup Details	11
7.1 Detection Algorithm.....	12
8 References	13

List of Figures

Figure 3-1. RCS Formula for a Trihedral Corner Reflector.....	3
Figure 3-2. Radar Sensor's Point of View.....	4
Figure 3-3. Detection Zone Visualization Example.....	5
Figure 3-4. Breakdown of Tolerance Zone Areas.....	5
Figure 4-1. Screenshots From the Response Time Video Showing the Before and After Static Residual Movement Begins....	6
Figure 4-2. Resulting Point Cloud of a Detection at 5.5m 65°.....	7
Figure 4-3. Image of Setup Used for Coexistence of Several RPDs Functional Test.....	7
Figure 4-4. Image of Setup Used for Interference by Object Outside the Detection Zone Functional Test.....	8
Figure 4-5. Comparison of Point Clouds for When the Interfering Target is Static (left) or Dynamic (right). In both Scenarios the Ability and Accuracy of Sensing the Test Target is Unaffected.....	8
Figure 4-6. Image of Setup for Interference by Object Inside the Detection Zone.....	9
Figure 4-7. Point Cloud Visualization of Human With Interfering Object Inside the Detection Zone.....	9
Figure 4-8. Range Profile Comparison, First Detected Point Goes From Under 100 dB to Over 110 dB in Relative Power.....	10
Figure 7-1. Picture of Linear Actuator setup With the Static Residual Movement's Specified Size Corner Reflector.....	11

Figure 7-2. Picture of an IWR6843AOP on a Tripod That is Pointed at the Corner Reflector at the Required Distance per Test.....	12
---	----

List of Tables

Table 7-1. Hardware.....	11
Table 7-2. Software.....	12

Trademarks

All trademarks are the property of their respective owners.

1 Introduction

In many safety systems found today, safety status devices such as pressure and optical/infrared sensors fail short of providing reliable human detection for safe operation and maximized up time. TI's mmWave radar sensors provides a strong solution, especially when integrated in a safety compliant system, and is able to pass safety certification standards that are applicable.

Many applicable safety standards are created by the *International Electrotechnical Commission* (IEC), and are used across all electrical, electronic, and related technologies. The [IEC TS 61496-5:2023](#) is a new safety standard created for safety-related systems that employ a Radar Protective Device (RPD) in order to detect people using a frequency-modulated continuous-wave (FMCW) transmission. A list of functional tests are defined by the standard to ensure proper sensor function and detection integrity under specified conditions.

The functional tests are used to check for various key abilities of the RPD, and this document focuses on providing results of the detection capability and integrity of the RPD for the more challenging tests. The RPDs used in this document are the [IWR6843AOPEVM](#) and [IWR6843ISK](#). A detection zone is set at a designated range that the RPD is to be certified to, and the desired target must still be detected regardless of conflicting influences stated by the standard.

2 TI mmWave Radar and Functional Safety

The [IWR6843](#) device is TI's high performance, functional safety certified, mmWave radar sensor. This sensor is supported by a wide range of evaluation tools, including hardware in the form of evaluation modules (EVMs) such as the [IWR6843ISK](#) and [IWR6843AOPEVM](#), as well as software via the examples found within the [Radar Toolbox](#) that are open source and can be used to replicate the content of this document.

In addition to the hardware and software tools available for TI mmWave products, the IWR6843 is already certified by TÜV SÜD for hardware integrity up to SIL 2 and systematic capability up to SIL 3 with accordance to IEC 61508. IEC 61508 is a risk-based standard, meaning the level of danger in hazardous environments is evaluated, and the appropriate safety measures are defined to avoid or control systematic failures in addition to detect and control random hardware failures and mitigate their effects. In contrast, IEC 61496-5 is for frequency-modulated continuous-wave (FMCW) radar devices that are in non-contact electro-sensitive protective equipment (ESPE) and assuring that appropriate safety-related performance is achieved. With IEC 61496-5 being a radar performance based standard, the testing in this document follows its scope and does not address certain topics required in IEC 61508. For this reason, the testing done did not use specific diagnostics and monitors, nor a safety variant version of the IWR6843AOPEVM.

For more information on functional safety, IEC 61508, and general steps taken in order to develop a functionally safe system, see the [Design Guide for Functional Safety Compliant Systems Using mmWave Radar Sensors](#)

3 IEC 61496-5 Functional Tests

The IEC 61496-5 safety standard has a list of tests and criteria needed to be met in order to determine proper sensing function and integrity of detection capability. Tests listed in the standard include and are not limited to:

- Detection capability
- Response time
- Position accuracy
- Coexistence of other RPDs
- Interference by objects inside detection zone
- Interference by objects outside detection zone
- Manual interference

The tests also list a range that the test target must be located at with respect to the RPD, as well as the size and speed of the test target. The difficulty of detection varies between simple detections such as a pedestrian walking 1.6 m/s perpendicularly to the RPD, to more difficult detections of the static residual movement of a *trihedral corner reflector with triangular sides (CR)* of approximate edge length 3.173 cm.

The standard requires you to specify a maximum detection distance for your system, which is used for testing and certification. For these tests, a maximum detection distance of 5.5 meters was selected. A majority of tests were passed at 8 meters with no changes to software or hardware, and with further optimization of detection algorithm and antenna design, it would be possible to pass all tests at extended distances.

3.1 Testing With Static Residual Movement

A person with a velocity of 0 m/s is static, but due to the breathing and heartbeat of an individual, there is still micro motion throughout the body that can be detected by the RPD. Static residual motion is defined by these micro motions. To emulate *static residual movement* using a trihedral target corner reflector, Section 5.2.3.5 defines the corner reflector needs to move 2 mm forward and 2 mm backwards with a velocity of 2 mm/s. To ensure that even the smallest micro movements done by individuals even slightly within the detection zone, the corner reflector test target is to have a RCS of 0.17 m².

$$\sigma_{\max} = \frac{4\pi L^4}{3\lambda^2}$$

Figure 3-1. RCS Formula for a Trihedral Corner Reflector

Based on the RCS formula for a trihedral corner reflector with L being the edge length and λ being the RPD's wavelength of 60 GHz, it must be of edge length 3.173 cm to achieve a RCS of 0.17 m². For the tests documented here, a corner reflector of radius 3 cm is used, which results in a RCS of 0.14 m², meaning the target used is more challenging to detect than what the standard requires.

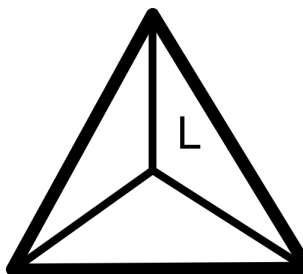
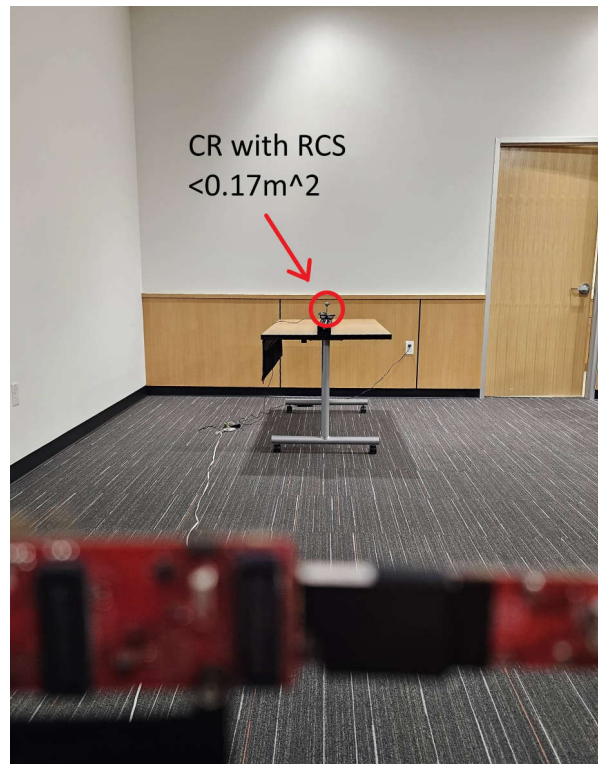

Figure 3-2. Radar Sensor's Point of View

3.2 Detection Zone

IEC 61496-5:4.2.12.2

By definition of the standard in Section 4.1.3, when a target is within the detection zone, an Output Signal Switching Device (OSSD) must switch the Electro-Sensitive Protective Equipment (ESPE) to the OFF state. A single fault resulting in deterioration of ESPE detection must create a lock-out condition of at least 5 seconds. The IWR6843 used in these tests acts as both the OSSD and ESPE due to the chip performing both the sensing and switching.

To emulate this, the Applications Visualizer ¹ is used to visualize the detection zone's size and status. When the zone is green, there is nothing being detected and no danger. When the zone is red, there is a detection and any electronics connected to the OSSD must be turned off to create a lock-out state. Note that all the processing and determination of zone size and status is done on the IWR6843 chip itself, with the visualizer only displaying the sensor point cloud output with no additional processing. Processing done on-chip includes the configured static clutter removal, where any detection with a Doppler of 0 is unreported. This prevents the detection of completely static objects such as walls and floors that clutter the point cloud.

In the visualizations of the radar output throughout this document, there is occasionally one or two single points of detection sporadically when there is no target or no movement. These are simple reflections, also known as noise or ghost points, and do not represent what the point cloud looks like when a real target is in view. These ghost points will importantly only cause over-detection, and not under-detection. Even with the 0.17 m^2 CR that represents the 99th percentile of an adult human according to ISO 7250-1, the CR appears with over 20 detections clustered tightly together.

¹ Visualizer with source code can be found within the [Radar Toolbox](#).

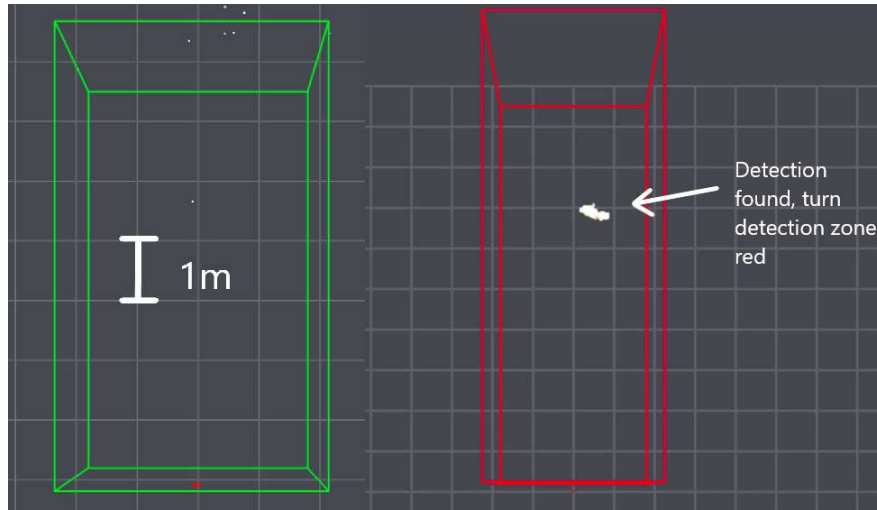

Figure 3-3. Detection Zone Visualization Example

3.3 Tolerance Zone

IEC 61496-5:4.2.12.2

As defined in Section 3.507, the tolerance zone is the zone outside of and adjacent to the supplier specified detection zone. The limited position accuracy zone is the area where a test target is still detected, but with a probability of detection lower than the required probability. As defined in Section 4.2.12.2, the test target shall be detected with a minimum probability of detection of 1×10^{-7} to 2.9×10^{-7} throughout the detection zones. The mathematics behind calculating probability of detection is out of scope of this document, but can be found in Annex BB in the standard.

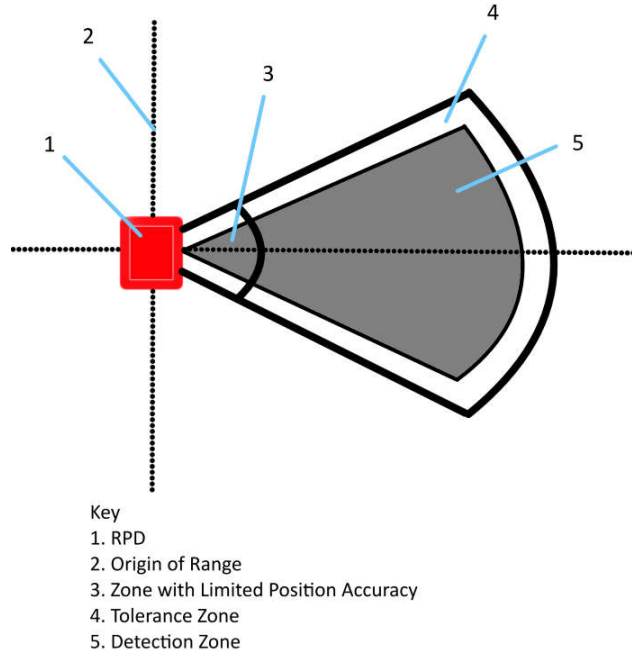

Figure 3-4. Breakdown of Tolerance Zone Areas

4 Results

The following sections go over the results of using the IWR6843ISK and IWR6843AOP across multiple functional tests.

4.1 Response Time

IEC 61496-5:5.2.2.1

IEC 61496-5:5.2.2.2

It is important for a safety sensor to be fast to report a detection within a safety zone. The response time in this test must be verified that to be lower than the response time declared by the specifications, using worst-case conditions and movement. For this test the 0.14m² CR* was used with static residual movement. The standard states that the recorded time must be lower than the response time declared by the supplier. This means that you must specify the minimum response time for your system.

An approximate 100 millisecond response time needed for there to be enough points to trigger a real detection and flip the zone to occupied was achieved. All processing is done on the IWR6843 chip. This response time can be further improved to be under 100 milliseconds with a low noise environment and due to the time needed to change the zone to occupied is configurable. For video footage of this test, visit the [Radar Toolbox version of this document](#) that includes embedded videos.

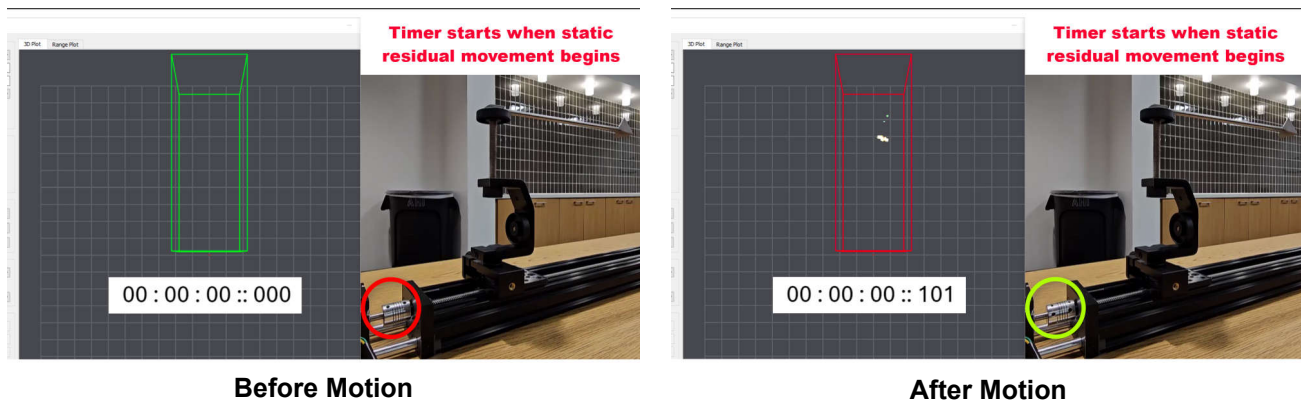

Figure 4-1. Screenshots From the Response Time Video Showing the Before and After Static Residual Movement Begins

4.2 Position Accuracy

IEC 61496-5:5.2.10

Although the most important aspect of a safety sensor is knowing if the safety zone is occupied, knowing where the occupant is with respect to the RPD is important as well. With the fundamentals of radar, there is a degradation in range and angle accuracy at maximum FOV as well as at and before the minimum detection distance of the RPD under test. The standard defines limited positional accuracy in Section 3.508 and Section 4.1.6 as the areas where the degradation mentioned above occurs.

4.2.1 Angular Accuracy Error Margins

Between the angles of -40° and 40° there can be an expected angular accuracy error of **around $\pm 1^{\circ}$** . At max FOV of around 60° you can expect an error of **around 5°** . This is a general case and angular accuracy may vary based on several factors such as antenna design, processing algorithm, calibration, and test target reflectivity.

For more details on angular and range accuracy as well as how it was measured, see [System Performance Measurement With the mmWave Sensor](#).

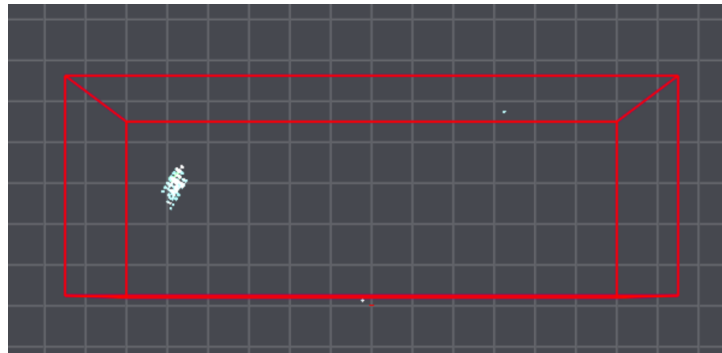

Figure 4-2. Resulting Point Cloud of a Detection at 5.5m 65°

As long as the target is not entirely in the first range bin, the accuracy of the range will be based on the chirp configuration's range resolution. The target being entirely in the first range bin only happens if the detected object is smaller than the chirp configuration's range resolution, which can go as low as 3 cm.

4.3 Coexistence of Several RPDs

IEC 61496-5:5.4.6.2

Due to the physics of FMCW millimeter wave radar and interference mitigation techniques, it is highly unlikely for other signals to disrupt the RPD's signal. However, the standard requests a test in Section 5.4.6 of having four RPDs as interfering targets with identical designs to the RPD under test. The CR must go through static residual movement while having no detection ability deterioration. While the test is underway, the interfering RPDs needs to be power cycled at least 10 times, over the course of two hours. This is to switch up the timings of the chirps.

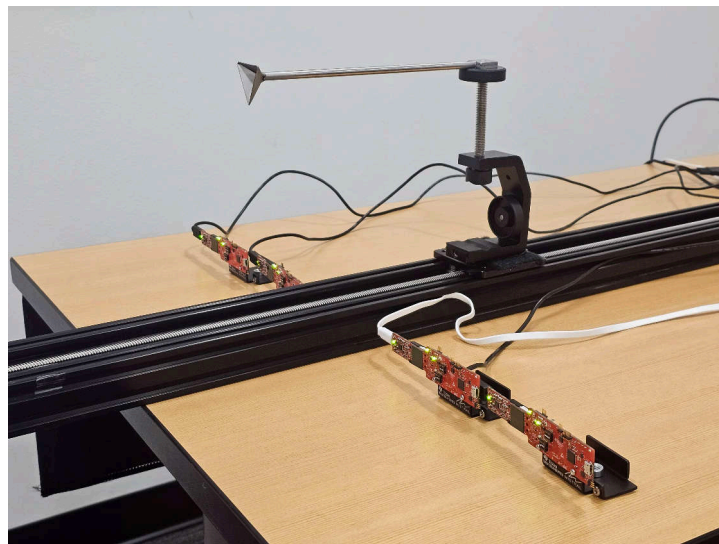

Figure 4-3. Image of Setup Used for Coexistence of Several RPDs Functional Test

The resulting point cloud was identical to what it would look like if there were no interfering RPDs at all. This is due to the configured static clutter removal algorithm removing any detections with 0 Doppler. Static clutter removal is not required, but it helps to visualize only moving targets. In addition the detection zone never changed to unoccupied while the target was inside the detection zone.

More details on interference involving multiple RPDs can be found in the document [Interference Mitigation For AWR/IWR Devices](#).

4.4 Interference by Object Outside the Detection Zone

IEC 61496-5:5.4.7.1

When there is a target object inside the detection zone, an interfering target outside the detection zone must not interfere with the target object's ability to be detected. For this test, Section 4.2.13.4 mentions a 40 m² CR is used as the interfering target in order to ensure it does not absorb the small 0.17 m² CR's visibility. The test calls for the interfering target to be static in one test and dynamic in another. In the dynamic test, the interfering target is moving at the same static residual movement speed as the test target. The interfering corner reflector should not be able to disrupt the detection CR's visibility, ensuring no disruption via outside objects.



Figure 4-4. Image of Setup Used for Interference by Object Outside the Detection Zone Functional Test

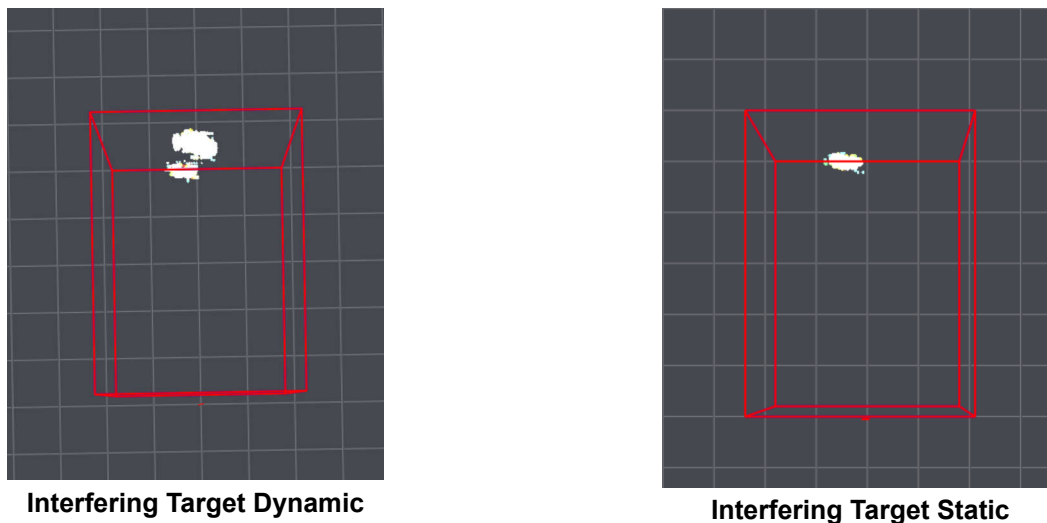

Figure 4-5. Comparison of Point Clouds for When the Interfering Target is Static (left) or Dynamic (right). In both Scenarios the Ability and Accuracy of Sensing the Test Target is Unaffected.

As seen above, the interfering target does not disrupt detection ability of the test target. While the interfering object is dynamic, there is still a clear distinction between it and the target, ensuring that the target is identified as inside the zone.

4.5 Interference by Object Inside the Detection Zone

IEC 61496-5:5.4.7.2

It must be ensured that detection capability of targets within the detection zone is not compromised when there is a metallic interfering object closer than the sensor's minimum distance. In Section 5.4.7.2.1, the standard mentions that the interfering object needs to be in the sensor's limited position accuracy zone.



Figure 4-6. Image of Setup for Interference by Object Inside the Detection Zone

With the interfering object at a distance of 5 cm, detection is affected but not compromised at 5 m. The points are more sparse and not as clustered, but the overall detection is strong enough to classify the zone as occupied.

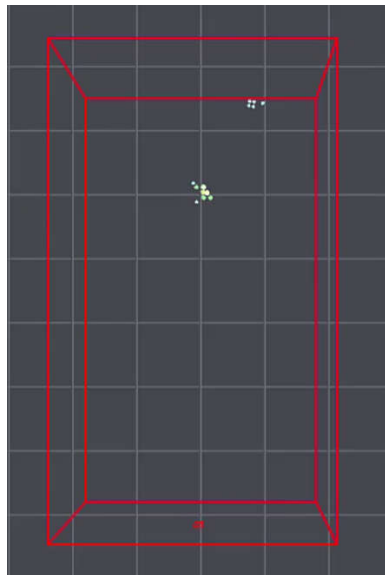

Figure 4-7. Point Cloud Visualization of Human With Interfering Object Inside the Detection Zone

In addition to the limited position accuracy test, immunity against occlusion within the detection zone shall be tested as well under very similar conditions. The difference being the interfering target is a metallic interfering object that covers 50% of the pedestrian test target. This test fundamentally is simpler as the interfering target in the example done covered around 90% of the target.

4.6 Manual Interference

IEC 61496-5:5.4.8

For safety purposes, the sensor must be immune to coverings. In Section 5.4.8, the standard calls for a test where 50% of the transmitting antennas are covered by a sheet of aluminum foil, and for the sensor to know that there is something covering it.

Due to the nature of the test, the point cloud is not the best visualization of the results due to points showing up in the 0th range bin due to antenna coupling. However, when looking at the range profile's 0th range bin, there is always at least a 20 dB increase in power when the aluminum foil covering was placed. This shows a large delta between antenna coupling, and antenna coupling with a reflective covering.

Figure 4-8 shows that the range profile was done using the browser [mmWave Demo Visualizer tool](#).

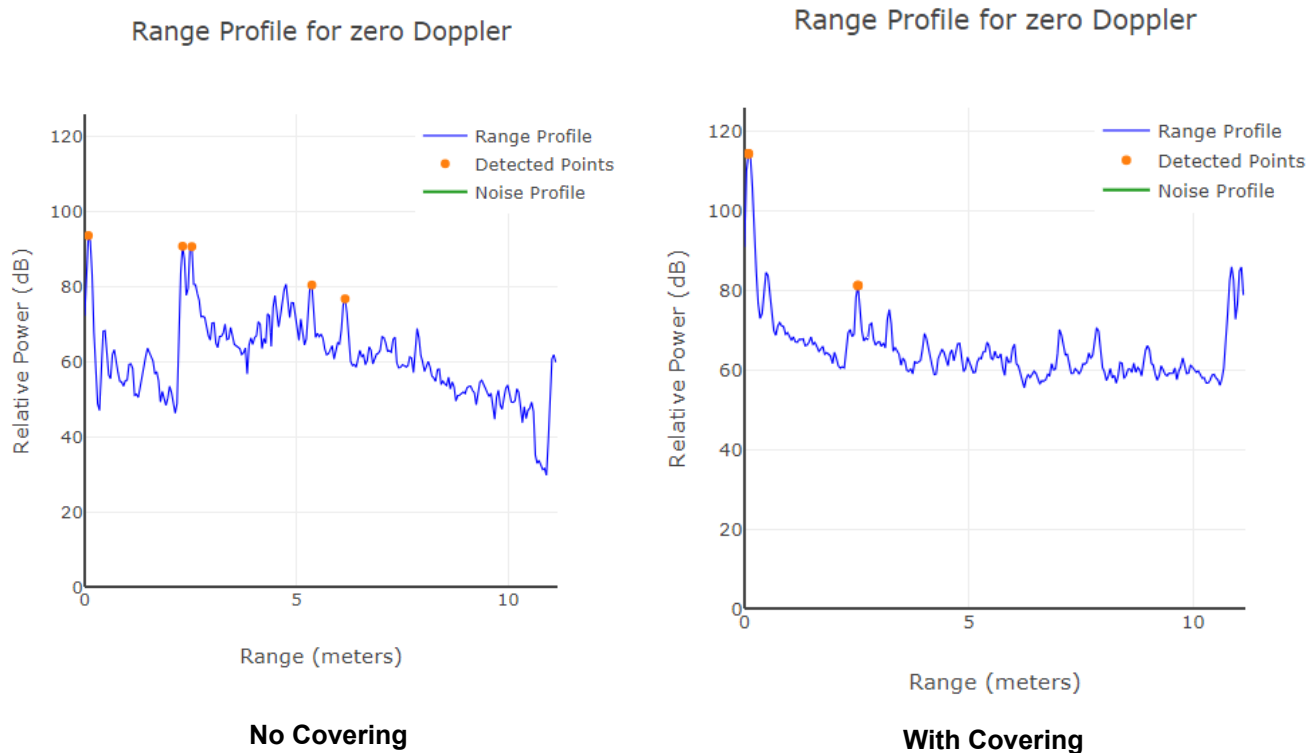

Figure 4-8. Range Profile Comparison, First Detected Point Goes From Under 100 dB to Over 110 dB in Relative Power

Due to the large delta of first few range bins seen between the setup with and without covering, monitoring these first few range bins and looking for any large jump in reflective power creates an effective solution to passing this test.

5 Environmental Tests

Environmental tests are not covered in this document but are listed in IEC 61496-5 as follows:

- Temperature variation and humidity test
- Condensing test
- Supply voltage variations and supply voltage interruptions
- Electrical disturbances except supply voltage variations and supply voltage interruptions
- Vibration
- Shock

6 Covered by Other Tests

Tests that are in IEC 61496-5 but are already covered by results shown in this document are as follows:

- Interference from other radio sources
- Sensitivity and Stability
- Detection of target with high RCS

Many of the hardware and system level tests vary based on the system in which the sensor chip is integrated. Detection of targets with high RCS has been shown throughout this page and would be redundant for the scope of this document. For more information regarding interference, see [Interference Mitigation For AWR/IWR Devices](#). With the interference mitigation techniques shown within the document, performance will be robust and reliable even in the presence of other signal emitting devices.

7 Test Setup Details

Table 7-1. Hardware

Tool	Details
C-Beam® Linear Actuator	1000mm with NEMA 23 Motor
IWR6843AOPEVM or IWR6843ISK	Both evaluation modules (EVM) were used for testing
DM542T Digital Stepper Driver	A stepper motor to allow accurate rotation speed for static residual movement
Microcontroller	Used to set speed of NEMA 23 Motor for static residual movement
Camera Tripod	Used to mount EVM to required height
Corner Reflectors	RCS of 0.14 m ² and 40 m ² . Stainless steel was used, however aluminum works as well.



Figure 7-1. Picture of Linear Actuator setup With the Static Residual Movement's Specified Size Corner Reflector



Figure 7-2. Picture of an IWR6843AOP on a Tripod That is Pointed at the Corner Reflector at the Required Distance per Test

Table 7-2. Software

Note that the versions listed were the most recent and what was used during the creation of this document. They are not necessarily the exact requirements needed to reproduce the results seen in this document.

Tool	Version	Download Link
MMWAVE-SDK	3.6	SDK Download Link
Radar Toolbox	2.10.00.04	dev.ti.com Toolbox Link
Applications Visualizer	2.1	User Guide Link
mmWave Demo Visualizer	3.6	Visualizer Link

7.1 Detection Algorithm

For all the tests shown in this document, the default 3D People Tracking demo was used with a default configuration file's chirp design. A required aspect of the configuration file's design was the usage of the fine motion algorithms to detect a target's static residual movement. For more details on fine motion, see the [Detection Layer Parameter Tuning Guide](#) for the 3D People Tracking Demo.

8 References

- Additional resources can be found in the following documentation:
 - For the webpage version of this document which includes several motion videos, visit the [Radar Toolbox](#)
- For definitions of chirp design parameters, refer to the MMWAVE-SDK User Guide document located at <MMWAVE_SDK3_INSTALL_DIR>\docs\mmwave_sdk_user_guide.pdf
- For details on the algorithm used in this document, see the [Detection Layer Parameter Tuning Guide](#) for the 3D People Tracking Demo
- Texas Instruments: For more information on functional safety, see the [Design Guide for Functional Safety Compliant Systems using mmWave Radar Sensors](#)
- For training and guides on radar fundamentals as well as functionally safe radar, see the [Radar Academy](#) library
- Texas Instruments: [System Performance Measurement With the mmWave Sensor](#)
- Texas Instruments: [Interference Mitigation For AWR/IWR Devices](#)
- Search for your issue or post a new question on the [mmWave E2E forum](#)

IMPORTANT NOTICE AND DISCLAIMER

TI PROVIDES TECHNICAL AND RELIABILITY DATA (INCLUDING DATA SHEETS), DESIGN RESOURCES (INCLUDING REFERENCE DESIGNS), APPLICATION OR OTHER DESIGN ADVICE, WEB TOOLS, SAFETY INFORMATION, AND OTHER RESOURCES "AS IS" AND WITH ALL FAULTS, AND DISCLAIMS ALL WARRANTIES, EXPRESS AND IMPLIED, INCLUDING WITHOUT LIMITATION ANY IMPLIED WARRANTIES OF MERCHANTABILITY, FITNESS FOR A PARTICULAR PURPOSE OR NON-INFRINGEMENT OF THIRD PARTY INTELLECTUAL PROPERTY RIGHTS.

These resources are intended for skilled developers designing with TI products. You are solely responsible for (1) selecting the appropriate TI products for your application, (2) designing, validating and testing your application, and (3) ensuring your application meets applicable standards, and any other safety, security, regulatory or other requirements.

These resources are subject to change without notice. TI grants you permission to use these resources only for development of an application that uses the TI products described in the resource. Other reproduction and display of these resources is prohibited. No license is granted to any other TI intellectual property right or to any third party intellectual property right. TI disclaims responsibility for, and you will fully indemnify TI and its representatives against, any claims, damages, costs, losses, and liabilities arising out of your use of these resources.

TI's products are provided subject to [TI's Terms of Sale](#) or other applicable terms available either on [ti.com](https://www.ti.com) or provided in conjunction with such TI products. TI's provision of these resources does not expand or otherwise alter TI's applicable warranties or warranty disclaimers for TI products.

TI objects to and rejects any additional or different terms you may have proposed.

Mailing Address: Texas Instruments, Post Office Box 655303, Dallas, Texas 75265
Copyright © 2024, Texas Instruments Incorporated