

# Application Brief

## Power Line Communication in Solar Applications



### Introduction

With the increased number of solar installations, importance of system monitoring and safety rises. In this trend, wired communications play a key role. Safety standards like SunSpec® Rapid Shutdown (RSD) which support NEC 2014, NEC2017 and UL1741 module-level rapid shutdown are built on wired communication interface. Besides the rapid shutdown functionality which is a hard requirement in most installations, module level power electronic (MLPE) monitoring is added to many systems.

Figure 1 shows typical power line communication options implemented in different solar installations. These installations can be divided into communication on DC lines (red) and communication on AC lines (blue). The difference is mainly on how the data-signal is coupled into a power line at a transmitter and how the signal is extracted at the receiver side.

Another option to distinguish is communication from solar panels towards the inverters and the communication towards the grid. Communication between an inverter and MLPE is used for monitoring PV panel operating conditions, fault detection and rapid shutdown. This is applicable for string inverters communicating to power optimizers and other MLPE, or for commercial string or central inverters where string or panel information is collected in combiner-boxes or directly at string input. The second communication option towards the grid is typically used to monitor and control multiple string inverters (done by grid operators to control power levels for grid stability), or in residential use-case to synchronize micro inverters to form split or three phase AC-grid or send operating information from individual micro inverters to a data aggregator.

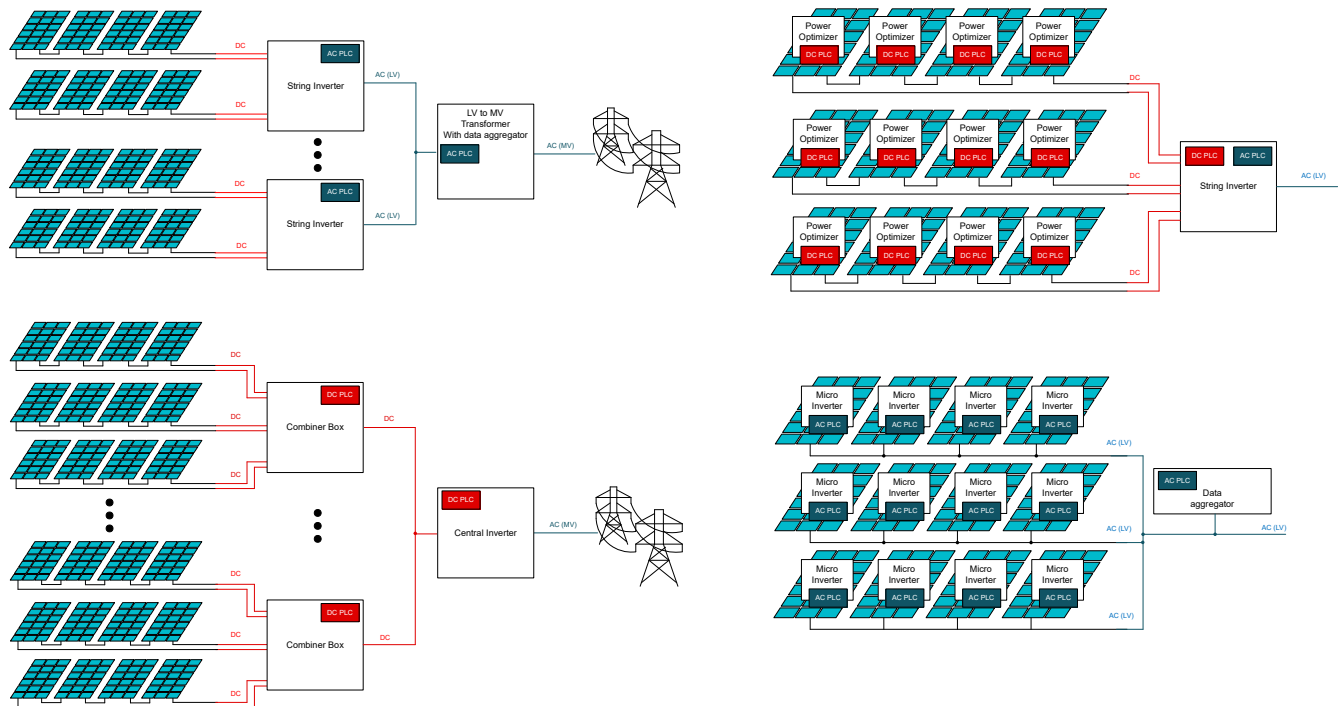


Figure 1. Typical Configurations of PLC in Solar Installations

## Narrowband vs. Broadband PLC

International standards and norms specify the frequency bands which can be used for power line communication. In general, there are two categories, narrowband - and broadband - PLC.

Narrowband PLC uses carrier frequencies up to 500 kHz. [Table 1](#) shows the available frequency bands for different regions. Narrowband PLC has the ability to communicate over wider distances and is often used in Smart Meters. Therefore, narrowband PLC fits very well in Solar to communicate over wider distance from PV-panel to string inverter input.

**Table 1. Narrowband PLC Standards and Frequency Bands**

Region	Organization	Frequency Band (kHz)
Europe	CENELEC	3-95 95-125 125-140 140-148.5
JAPAN	ARIB	10-450
CHINA	EPRI	3-90 3-500
USA	FCC	10-490

Broadband PLC uses frequencies above 2MHz, thus offering higher data rates and also has lower range compared to narrowband PLC and a significant higher power consumption. A brief comparison is shown in [Table 2](#).

**Table 2. Comparison of Narrowband- and Broadband-PLC**

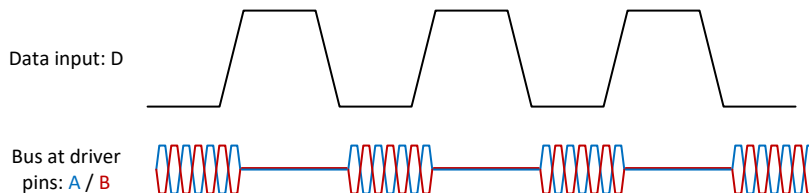
	Narrowband PLC	Broadband PLC
Data rate	< 200kbps	>1Mbps
Range	< 1km	< 100m
Frequency bands	< 500kHz	> 2MHz
Power consumption	Low	High
Modulation	OOK, FSK, OFDM	OFDM, QAM, QPSK

## Modulation Schemes Used in Narrowband PLC

There are different modulation schemes used in power line communication. In narrowband application On-Off-Keying (OOK), Frequency-Shift-Keying (FSK) and Orthogonal Frequency Division Multiplexing (OFDM) are the most common modulations, while in broadband PLC mainly OFDM is used. In this chapter these three modulation techniques are described in more detail.

### On-Off-Keying (OOK)

This simplest form of modulation encodes binary ones and zeros by transmitting a defined carrier frequency for example for a logic “0” or sending nothing for a logic “1” (see [Figure 2](#)). Both, modulation and demodulation can be done by a simple transceiver like the [THVD8000](#), without the requirement of any additional digital decoding in a microcontroller or processor. To have enough drive capability, when long cables are involved, a line-driver OPAMP like [THS6222](#) or [THS6232](#) in combination with a coupling circuit is needed.

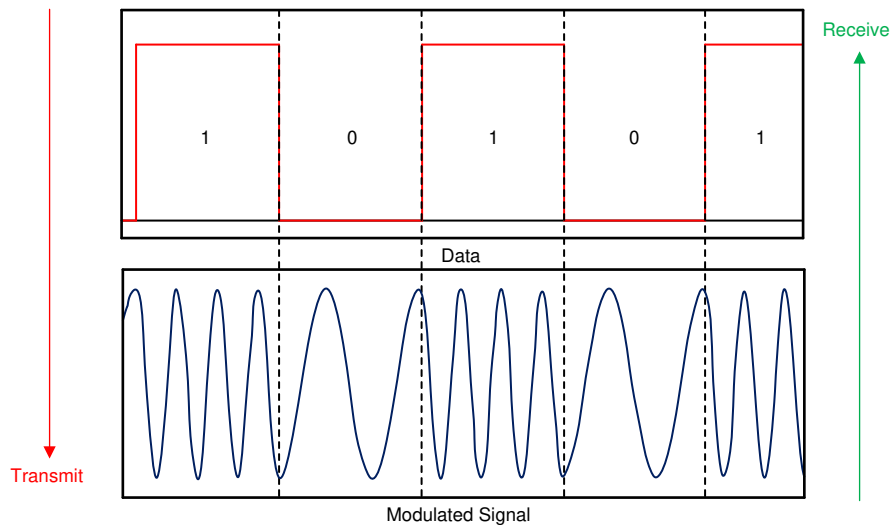


**Figure 2. Power Line Coding Example for OOK**

A reference design that shows how OOK can be used for Solar applications is [TIDA-010935](#). The reference design has all needed circuitry to run a simple OOK modulation. The design is built in a booster-pack configuration that can be controlled by a [MSPM0](#) MCU, but other MCU-booster-packs can be used as well.

### Frequency-Shift-Keying (FSK)

In Frequency-Shift-Keying (FSK) different carrier frequencies are used to encode the data in symbols. A symbol is the smallest amount of data which can be transmitted through a communication channel. Depending on the number of frequencies used, a number of bits can be transmitted per symbol. In the simplest form of binary FSK (BFSK) only two frequencies are used. One of the frequencies is used to transmit a logic '0' and the other one is used to transmit a logic '1'. In this case those carriers are called mark frequency and space frequency. A variant of BFSK is spread frequency shift keying (S-FSK) which is used in SunSpec RSD. In S-FSK mark and space frequencies are spaced far enough to avoid that narrowband interference disturbs both frequencies. In this way the receiver can still recover data even if one of the two frequencies is blocked by a disturbing signal in the system. [Figure 3](#) shows an illustration of S-FSK.



**Figure 3. Time Domain Coding for S-FSK**

For demodulation the signal is sampled at least twice the highest carrier frequency. This is typically done by a microcontroller, which also runs the demodulation algorithm. The demodulation algorithm is only sensitive to the specified carrier frequencies, which makes the algorithm robust to broadband noise, but weak against narrowband interference at the exact carrier frequencies. For solar application it is important to keep the switching frequencies of power conversion systems far enough away from the selected carrier frequencies to not impact the communication channel.

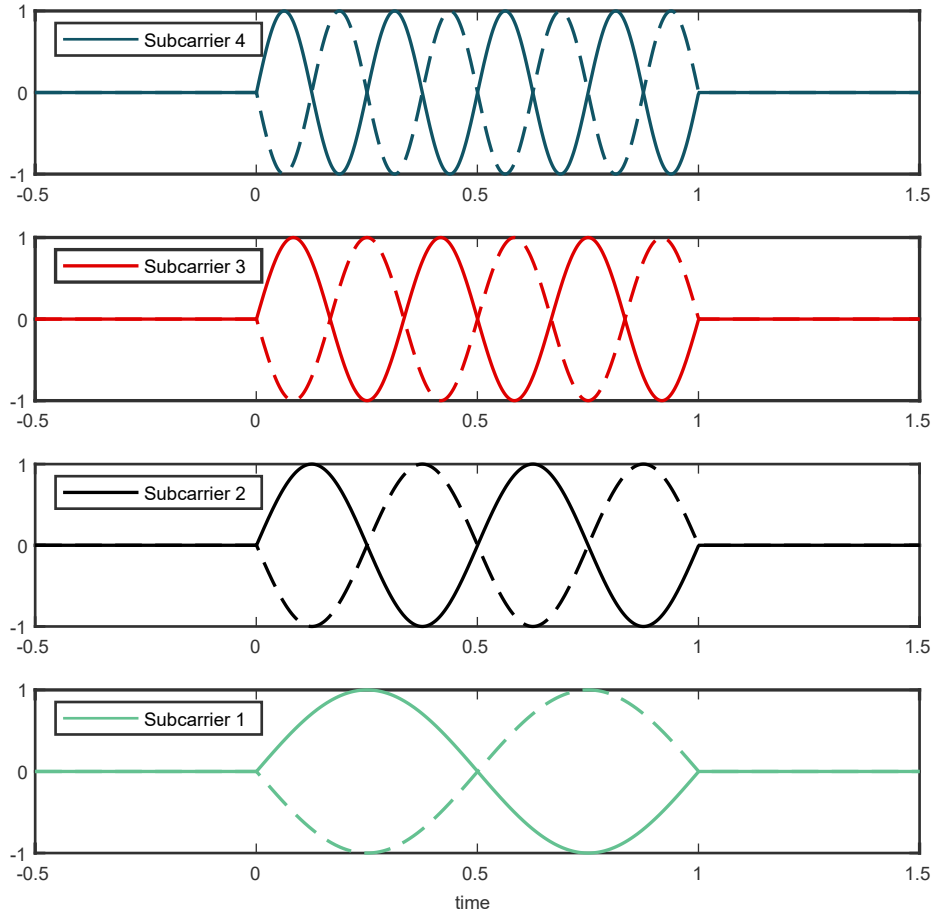
[TIDA-060001](#) is a reference design where S-FSK for a SunSpec Rapid Shutdown transmitter or receiver has been realized. The design uses an integrated analog front end IC: [AFE031](#). All needed software for FSK modulation and demodulation is available for [TMS320F280049C](#) in the [C2000-WARE-SDK](#), which makes it easy portable to other members of the [C2000 Family](#). For example in the solar-power-optimizer reference design [TIDA-010949](#) the Rapid Shutdown receiver software has been ported over to [TMS320F2800137](#). The reference design works very robust since the power optimizer is running a 300kHz which is far away from the carrier frequencies used in this communication example.

### Orthogonal Frequency Division Multiplexing (OFDM)

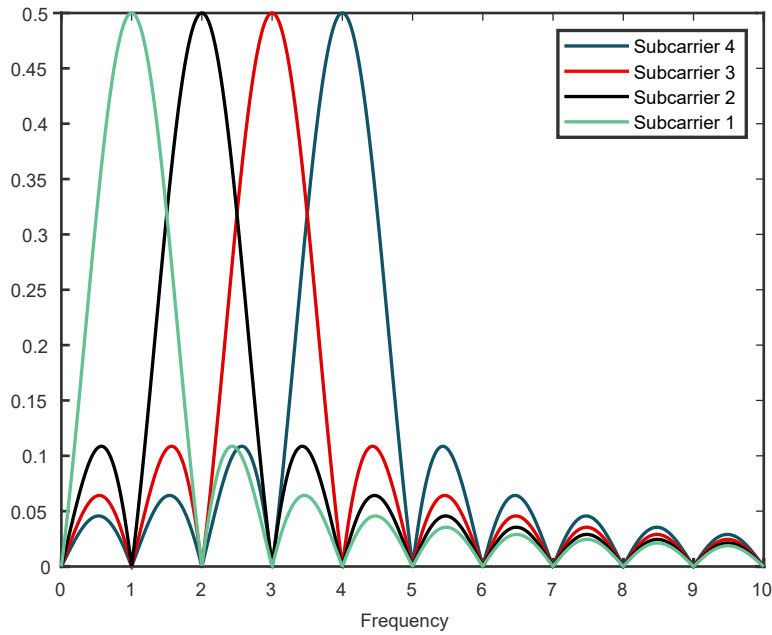
The last described modulation technique in this article is OFDM. In OFDM, the data stream is divided and transmitted via multiple subcarriers. Orthogonal subcarriers are used to guarantee minimal interference between them. Each subcarrier is modulated with a conventional modulations scheme like phase-shift keying (PSK) or differential phase shift keying (DPSK). Using multiple tightly spaced subcarriers increase the data rate significantly. One example where OFDM is used is in Smart Meters, where standards like G3 and PRIME use

OFDM with more than 100 subcarriers. This enables data rates up to a few 100kbit in narrowband operation. OFDM can also be used to increase robustness in noisy environment which is very typical in solar applications. Monitoring the signal quality on the subcarriers and removing those which have a bad signal to noise ratio or using multiple subcarriers redundant increased the overall robustness.

Figure 4 and Figure 5 illustrates an example for OFDM Modulation using four subcarriers. Each of the subcarriers uses PSK to encode one bit. All these signals are summed up and transmitted. The effect of selecting orthogonal subcarriers is shown in the frequency domain. The peaks of the carrier frequencies occur at the zero crossings of the other subcarriers. This provides minimal inter-symbol interference (ISI), in other words increased the robustness of data transmission.

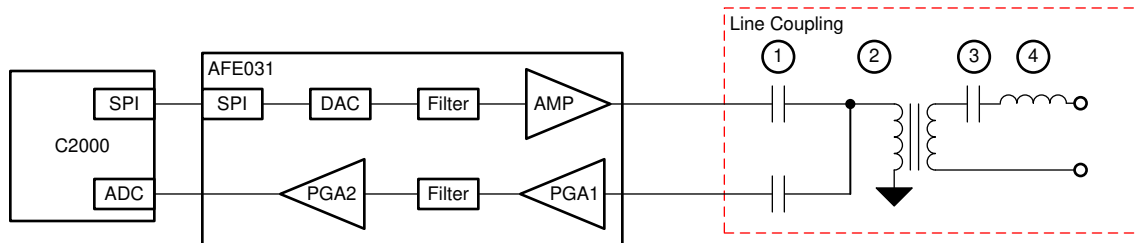


**Figure 4. OFDM Signals in Time Domain**



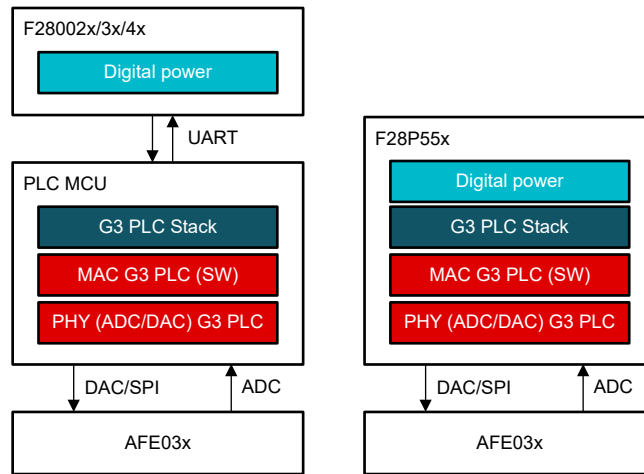
**Figure 5. OFDM Signals in Frequency Domain**

A possible implementation of a PLC transceiver with a C2000 MCU and [AFE031](#) is given in [Figure 6](#). For transmit operation the MCU controls the DAC inside the AFE031 via SPI. The DAC-output is additionally filtered, then amplified and coupled into the power line. For the receive path, the incoming signal is propagating through the line coupling circuit, entering into the programmable gain stage (PGA1), bandpass-filtered again and then being amplified by an additional programmable gain stage (PGA2) before being sampled by the internal ADC of a MCU. All software for encoding and decoding signals is running on the MCU (for example, [TMS320F28069](#) or [TMS320F28P550](#)).



**Figure 6. Simplified Line Coupling Circuit for AC Main**

Multiple MCU partitioning are possible as depicted in [Figure 7](#). Running the PLC SW on a dedicated MCU and having a separate MCU for other functions like digital power control. Or combining all into one MCU that runs the power line communication protocol and the digital power control in different interrupt service routines.



**Figure 7. MCU options for power line communication**

**Summary**

There are different modulation schemes possible for narrowband PLC in solar applications. The pros and cons are summarized in [Table 3](#). For simple low data rate applications OOK can be sufficient. FSK adds some additional robustness and is therefore well suited for safety application with low data rate requirements. In monitoring systems, where a large number of nodes is transferring more data to a data aggregation, the bandwidth of FSK and OOK is not sufficient. In these systems OFDM is a good option.

**Table 3. Comparison of Narrowband Modulation Schemes**

	OOK	FSK	OFDM
<b>Complexity</b>	simple	moderate	complex
<b>Data rate</b>	low	low	high
<b>Robustness</b>	low	moderate	robust

**Trademarks**

SunSpec® is a registered trademark of SunSpec Alliance, Inc. All trademarks are the property of their respective owners.

## IMPORTANT NOTICE AND DISCLAIMER

TI PROVIDES TECHNICAL AND RELIABILITY DATA (INCLUDING DATA SHEETS), DESIGN RESOURCES (INCLUDING REFERENCE DESIGNS), APPLICATION OR OTHER DESIGN ADVICE, WEB TOOLS, SAFETY INFORMATION, AND OTHER RESOURCES "AS IS" AND WITH ALL FAULTS, AND DISCLAIMS ALL WARRANTIES, EXPRESS AND IMPLIED, INCLUDING WITHOUT LIMITATION ANY IMPLIED WARRANTIES OF MERCHANTABILITY, FITNESS FOR A PARTICULAR PURPOSE OR NON-INFRINGEMENT OF THIRD PARTY INTELLECTUAL PROPERTY RIGHTS.

These resources are intended for skilled developers designing with TI products. You are solely responsible for (1) selecting the appropriate TI products for your application, (2) designing, validating and testing your application, and (3) ensuring your application meets applicable standards, and any other safety, security, regulatory or other requirements.

These resources are subject to change without notice. TI grants you permission to use these resources only for development of an application that uses the TI products described in the resource. Other reproduction and display of these resources is prohibited. No license is granted to any other TI intellectual property right or to any third party intellectual property right. TI disclaims responsibility for, and you will fully indemnify TI and its representatives against, any claims, damages, costs, losses, and liabilities arising out of your use of these resources.

TI's products are provided subject to [TI's Terms of Sale](#) or other applicable terms available either on [ti.com](https://www.ti.com) or provided in conjunction with such TI products. TI's provision of these resources does not expand or otherwise alter TI's applicable warranties or warranty disclaimers for TI products.

TI objects to and rejects any additional or different terms you may have proposed.

Mailing Address: Texas Instruments, Post Office Box 655303, Dallas, Texas 75265  
Copyright © 2024, Texas Instruments Incorporated