

Analyzing PCB Thermal Resistance in High-Accuracy Temperature Sensors



Mihail Gurevitch

ABSTRACT

In emerging technologies such as AR/VR headsets, achieving fast thermal response times and high accuracy can help optimize performance, safety, and user experience. Fast thermal response times minimize the delay between actual and measured temperatures, which is essential in environments where immediate reaction to temperature changes is necessary to prevent system failures and enhance reliability.

This application note examines the thermal response characteristics of the [TMP116](#) (0.20°C accuracy), [TMP117](#) (0.10°C accuracy), and [TMP119](#) (0.08°C accuracy) temperature sensors. The application note highlights the impact of package selection and PCB design on thermal performance. Sensors with lower thermal mass, like the TMP117, in the DSBGA package, offer a faster thermal response times compared to those in WSON/QFN packages, due to the reduction the IC thermal mass. Achieving real-time precise surface temperature measurements in various applications, it is important to have minimal thermal resistance between the measured object surface and the sensor package. High thermal resistance can lead to sensor temperature shift from the measured object, as well as a delayed thermal response time.

This application note provides information about thermal resistance measurements made for different kinds of sensor packages mounted on varying thicknesses of rigid PCB, as well as flexible PCB. Flexible PCB, with reduced thermal mass, demonstrate significant advantages in settling time, achieving quicker and more accurate temperature readings.

Table of Contents

1 Introduction	2
2 Sensor - Object Surface Thermal Resistance and the Importance for Measurement Precision	3
3 Testing	4
3.1 Hardware Setup.....	4
3.2 Test Setup.....	5
3.3 Test Method.....	6
4 Thermal Parameters Calculations	8
5 Summarizing and Interpreting Test Results	9
6 Summary	11
7 References	11
8 Revision History	12

Trademarks

Kapton® is a registered trademark of DuPont.
All trademarks are the property of their respective owners.

1 Introduction

High-accuracy temperature sensing is critical in many applications. Achieving this requires minimal thermal resistance between the measured object surface and the sensor package. High thermal resistance can cause a sensor's temperature reading to shift away from the actual object temperature and delay thermal response time. This application note details the thermal resistance measurements conducted on different sensor packages, such as the [TMP116](#), [TMP117](#), and [TMP119](#), mounted on varying thicknesses of rigid PCB and flexible PCB.

The primary objective of these measurements was to understand how package selection and PCB design impact thermal performance. By comparing sensors with different thermal masses and configurations, we aimed to identify the setups that provide the quickest and most accurate thermal response. Sensors with lower thermal mass, like the [TMP117](#) and [TMP119](#) in a WCSP DSBGA package, showed significantly faster response times than those in WSON/QFN packages, highlighting the importance of reducing the IC thermal mass.

Additionally, flexible PCB were examined due to their potential for reducing overall thermal mass and enhancing thermal performance. Our experiments demonstrated that flexible PCB can achieve quicker and more accurate temperature readings than rigid PCB. This finding underscores the benefits of flexible PCB in applications where rapid thermal response is essential.

This document provides detailed results from these thermal resistance measurements and offers practical design tips for optimizing the thermal response of temperature sensors in various applications. By leveraging the insights from this study, designers and layout engineers can make informed decisions about sensor packaging and PCB design to achieve designed for thermal performance.

2 Sensor - Object Surface Thermal Resistance and the Importance for Measurement Precision

A significant part of all temperature measurements is measuring the surface temperature of some object. The classical way to do this is by measuring object temperature through the PCB board as [Simplified Schematic of Temperature Flow During Solid Surface Temperature Measurement](#) shows.

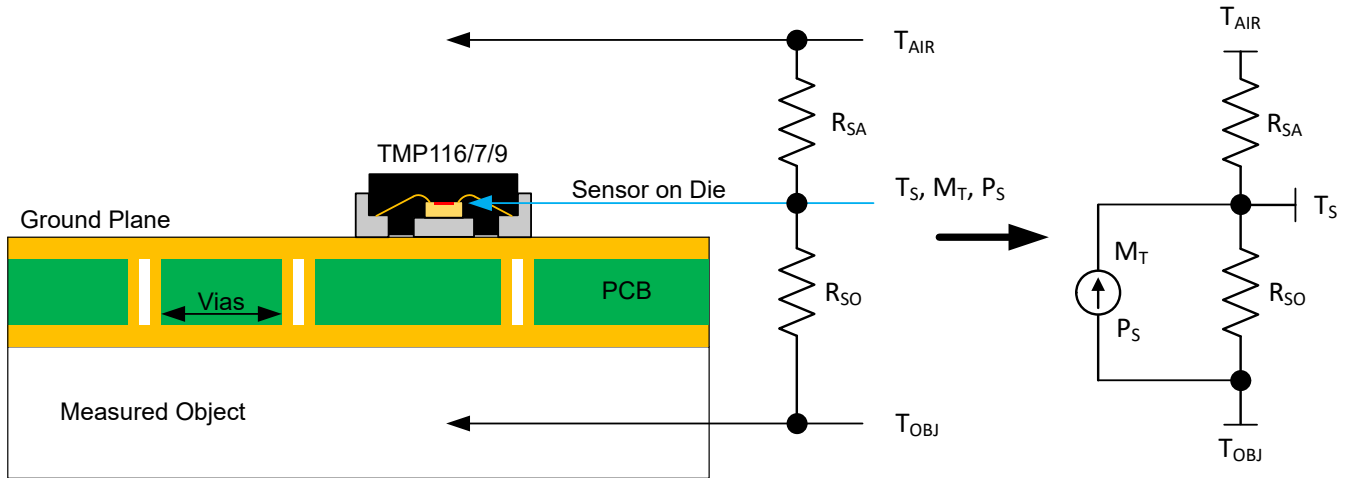

Figure 2-1. Simplified Schematic of Temperature Flow During Solid Surface Temperature Measurement

Where,

- T_{OBJ} is the measured object temperature
- T_{AIR} is the ambient temperature (typically air)
- T_S is the internal sensor temperature
- R_{SO} is the thermal resistance between the sensor and the object
- R_{SA} is the thermal resistance between the sensor and the air (environment)
- P_S is the average power dissipated by the sensor during the measurement
- M_T is the combined thermal mass of device and PCB

From the schematic, these parameters can be related by

$$T_{OFS} = R_{SO} \times \frac{T_{OBJ} - T_{AIR}}{R_{SO} + R_{SA}} \quad (1)$$

where

- T_{OFS} is a temperature offset between the measured object and the sensor

[Equation 1](#) shows that the sensor temperature offset is zero only in two cases: if R_{SO} is zero or if R_{SA} is infinite. If there is a difference between T_{OBJ} and T_{AIR} (and R_{SA} is not significantly higher than R_{SO}), some offset between the sensor and object temperature can be observed. This shift increases as the difference between T_{OBJ} and T_{AIR} increases, or when R_{SA} becomes smaller and approaches the R_{SO} value.

It is very important for precise measurements to minimize the value of R_{SO} and properly estimate it during design. The value of R_{SO} directly affects the sensor offset, the sensor temperature settling time, and, potentially, the need to perform system calibration. See the [Precise Temperature Measurements With the TMP116 and TMP117](#), application note for more the details.

3 Testing

3.1 Hardware Setup

The purpose of the following measurements was to determine the thermal resistance values for the QFN and WCSP BGA packages of the TMP116, TMP117, and TMP119 soldered to PCB of varying thickness and composition.

The following parts and PCB were used during these tests:

- **Devices**
 - **TMP116 and TMP117 parts** in the QFN-6 (DRV) package.
 - **TMP119/TMP117 parts** in the WCSP-6 (YBG) package.
- **Boards**
 - **Rigid PCB (11mm × 22mm) coupon boards** with a thickness of 64 mils.
 - **Rigid PCB (11mm × 22mm) coupon boards** with a thickness of 32 mils.
 - **Flex PCB (11mm × 22mm) coupon boards** with a thickness of 6 mil.

3–4 coupon boards (CB) were tested for each case. During the test runs, QFN packaged parts were assembled to examine both the soldered and non-soldered thermal pad (TP) conditions. [DRV and YBG Parts Coupon Boards Used in the Tests](#) shows various example coupon boards used in the tests.

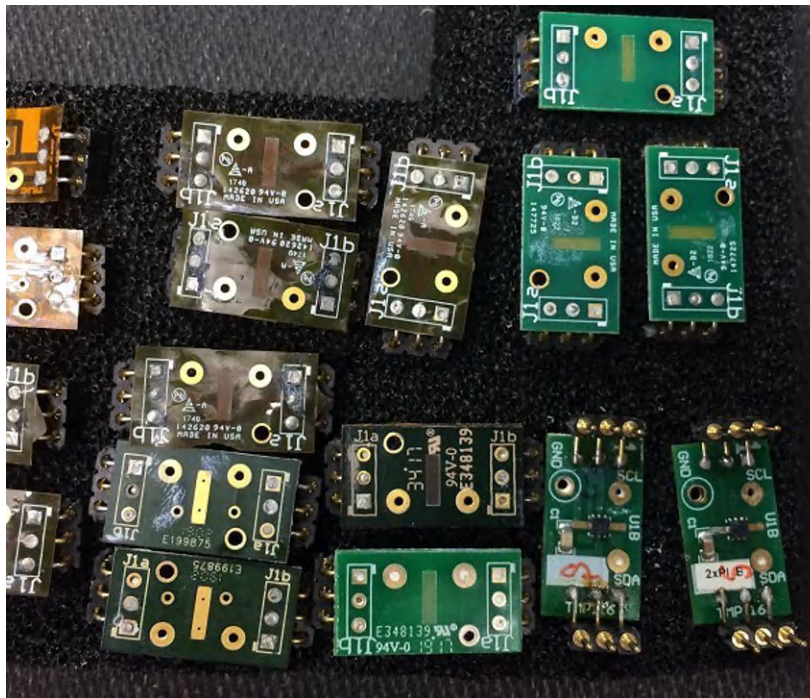

Figure 3-1. DRV and YBG Parts Coupon Boards Used in the Tests

3.2 Test Setup

For each test, we quickly stepped up the dissipated power of the device and then sequentially stepped the power down. This is achieved by sharply changing the supply voltage to increase the quiescent current of the device, thereby altering the dissipated power. This fluctuation in power results in a temperature change during the test, allowing us to calculate the system's thermal parameters through constantly monitored internal temperature and power. In these experiments, the temperature flow is opposite to the expected norm: the temperature flow and changes are coming from the object, and the sensor follows the object. Due to the small sensor thermal mass, there is a possibility to heat the sensor quickly, creating a situation close to an ideal thermal step function, allowing the use of Gaussian step equations under specific conditions. The following steps outline the test setup:

1. Thermal Head Setup

- Massive copper thermal heads were attached under a stable and controlled temperature of +21°C (close to room temperature) to minimize the influence of convection airflows. This makes sure that the sensor's self-heating during the tests does not affect the thermal head temperature.
- To avoid short circuits of the CB on the bottom side of the PCB, the copper thermal head is covered by 1-mil Kapton® tape to electrically isolate the thermal head from the coupon board.

2. Thermal Contact Optimization

- A tiny layer of thermal grease was applied between the coupon board and the thermal head to improve thermal contact.
- To stabilize the thermal contact further and prevent temperature leakage from the device under test (DUT) to the surrounding air, the coupon board is pressed to the thermal head by a porous rubber stick with controlled force.

3. Test Chamber Conditions

- To avoid the influence of room air movement, the thermal head with the attached coupon board was placed into a closed test chamber and kept there for at least 15 minutes before the test.

4. DUT Setup

- Only one DUT is tested at a time to make sure of accuracy.
- Each coupon board has a 0.1µF surface mount voltage supply ceramic capacitor populated on the V+pin and referenced to GND.
- The I2C bus runs at 400kHz with a 3V pullup voltage, which does not change during the test.
- The DUT supply changes during the test in the following steps: 3V → 5.5V → 3V. This leads to a device supply power consumption change: 0.4mW → 5.5mW → 0.4mW. The time on each supply voltage step is 15s.
- The DUT is in continuous conversion mode with 8 internal averaging and no pause between conversions. The temperature data are transferred from DUT every 150ms.

Figure 3-2 shows the test setup, containing the thermal head, an example connected coupon board, and the rubber stick used in the experiments.

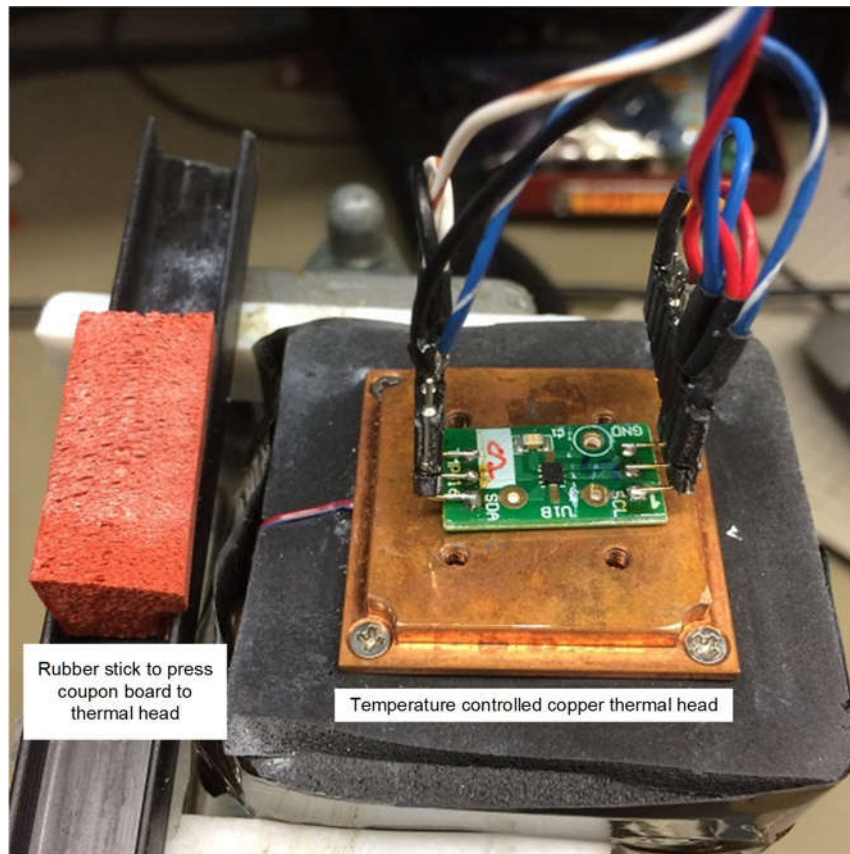

Figure 3-2. Experimental Setup

3.3 Test Method

The coupon board attached to the thermal head was kept in a closed test chamber until DUT temperature readings stabilized. Once this steady state condition was reached, the following steps outline the test procedure:

1. Initial Setup

- The device is powered up, and the supply is set at 3V. The DUT is placed into continuous conversion mode. Throughout the entire procedure, temperature data is continuously collected, and DUT supply current is continually measured.

2. Voltage Step-Up

- After 15 seconds, the supply voltage is stepped up to 5.5V. The I2C bus voltage remains at 3V. This step uses the device digital input cells to consume additional current while the input level is 3V but the supply is 5.5V. This leads to significant sensor self-heating, which can be avoided during normal measurements.

3. Voltage Step-Down

- After 15 seconds, the supply voltage is stepped back down to 3V.

3.3.1 Measurement Results

Rigid PCB Coupon Boards (11mm × 22mm, with a thickness of 64 mils)

[Thermal Response, 64mil Rigid CB, DRV Package, Thermal Pad Soldered](#) and [Thermal Response, 64mil Rigid CB, DRV Package, Thermal Pad not Soldered](#) display the thermal response for a 64mil rigid PCB with QFN packaged parts, both with and without soldered thermal pads. The data show that when the thermal pad is soldered, the thermal resistance is about twice as low compared to when it is not soldered. In both cases, the stabilization time for heating and cooling is approximately 5 seconds.

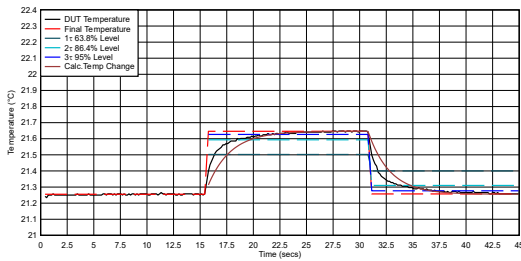

Figure 3-3. Thermal Response, 64mil Rigid CB, DRV Package, Thermal Pad Soldered

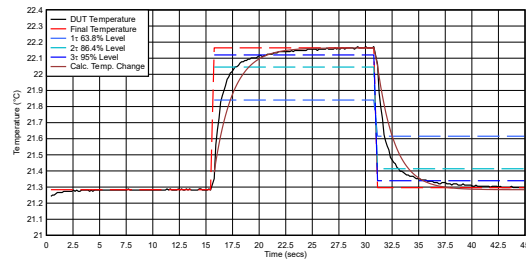

Figure 3-4. Thermal Response, 64mil Rigid CB, DRV Package, Thermal Pad not Soldered

Note that the 63.8%, 86.4%, and 95% levels of the final temperature steps align with the Gaussian step function temperature change diagram. The deviation from the ideal step function is more pronounced in the 64mil rigid PCB, while the 32mil thick PCB shows a closer match to the ideal curve.

Flex PCB Coupon Boards (11mm × 22mm, with a thickness of 6 mil)

[Thermal Response, 6mil flex CB, DRV Package, Test Point Soldered](#) and [Thermal Response, 6mil flex CB, DRV Package, Test Point not Soldered](#) highlight the thermal response of the device on a 6mil flexible PCB with QFN packaged parts. When the thermal pad is not soldered, the self-heating temperature is 1.8 to 2 times higher than in the soldered condition. The stabilization time for heating and cooling improves to 3-4 seconds. The data indicate that the heating and cooling curves match the calculated ideal curve due to the reduced connected thermal mass of the flexible PCB.

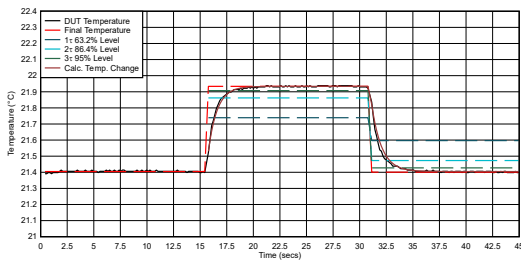

Figure 3-5. Thermal Response, 6mil flex CB, DRV Package, Test Point Soldered

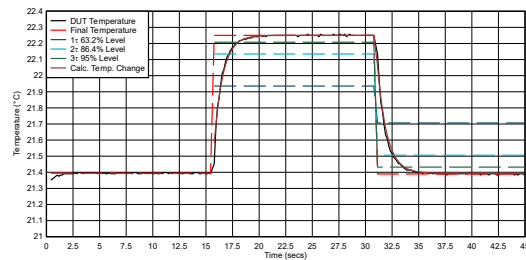

Figure 3-6. Thermal Response, 6mil flex CB, DRV Package, Test Point not Soldered

Rigid PCB (11mm × 22mm, 32 mil thickness) vs. Flex PCB (11mm × 22mm, 6 mil thickness)

[Thermal Response, 32mil Rigid CB, YBG Package](#) and [Thermal Response, 6mil flex CB, YBG Package](#) show the temperature change on rigid and flexible PCB with BGA WCSP parts. The thermal step similarity in both cases indicates that the primary thermal resistance comes from the BGA package and PCB contacts, not from the PCB. The 6mil flexible PCB achieve a settling time of less than 2 seconds, with the heating curves closely aligning with the ideal step function curves. This improvement can be attributed to the lower thermal mass of the flexible PCB.

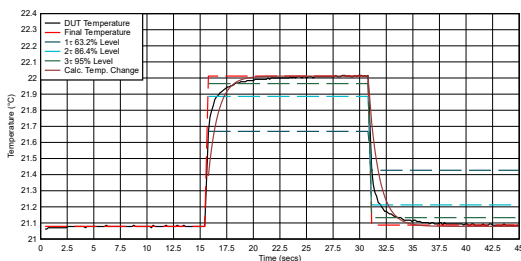

Figure 3-7. Thermal Response, 32mil Rigid CB, YBG Package

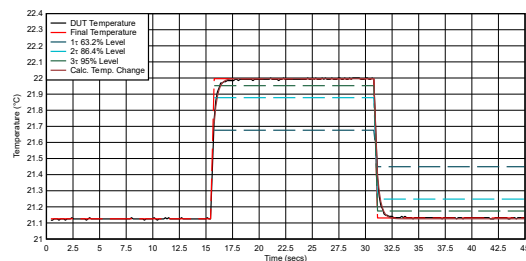

Figure 3-8. Thermal Response, 6mil flex CB, YBG Package

4 Thermal Parameters Calculations

If the DUT temperature change is known as the corresponding dissipated power changes, there is the possibility to calculate the thermal resistance (RT) between the sensor and the thermal head.

This parameter is calculated as:

$$R_T = \frac{T_1 - T_2}{P_1 - P_2} \quad (2)$$

where

- P_1 and P_2 are the dissipated power on step 1 and 2 in [Section 3.3](#)
- T_1 and T_2 are sensor settled temperature on step 1 and 2 in [Section 3.3](#)

Estimating the 95% of step final temperature as a $3 \times \tau$ point, it is possible to estimate the system time constant. Despite this self-heating and cooling process not fully matching the ideal Gaussian curve, the time constant remains a convenient way to estimate the process speed. Knowing the time constant and thermal resistance (RT), there is the possibility to calculate the sensor's effective thermal mass for each soldering case as:

$$M_T = \frac{\tau}{R_T} \quad (3)$$

There is importance in understanding that [Equation 3](#) calculates the effective thermal mass, which is larger than the package thermal mass, because thermal mass also includes the connected PCB area around the soldered device.

5 Summarizing and Interpreting Test Results

The following figures summarize the test results for different sensor packages and PCB configurations, including the following configurations:

- Devices in WCSP BGA package (WCSP)
- Devices in QFN/WSON package with thermal pad soldered (TPS)
- Devices in QFN/WSON package with no thermal pad soldered (nTPS)

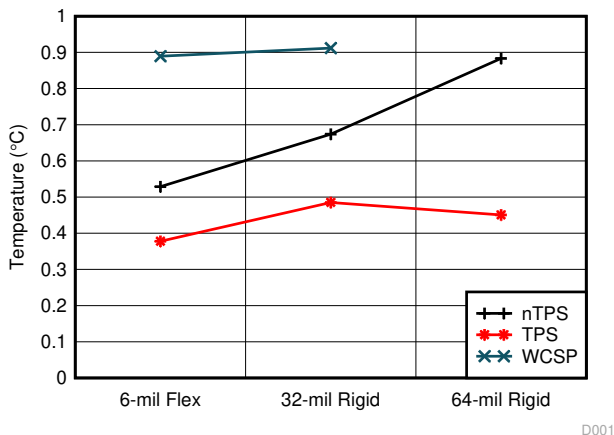

Figure 5-1. Average TMP117 Self-Heating Temperature Offset vs. PCB Thickness

The following observations come from Figure 5-1:

- **Devices in WCSP BGA package (YBG):** The WCSP devices have the highest self-heating offset, which is nearly independent of board thickness.
- **Devices in QFN/WSON package (DRV), with thermal pad (TP) soldered:** The QFN devices with soldered TPs (TPS) exhibit the lowest self-heating temperatures versus the thermal pad not soldered (nTPS).
- **Board Thickness:** The self-heating temperature is proportional to board thickness, which is expected.

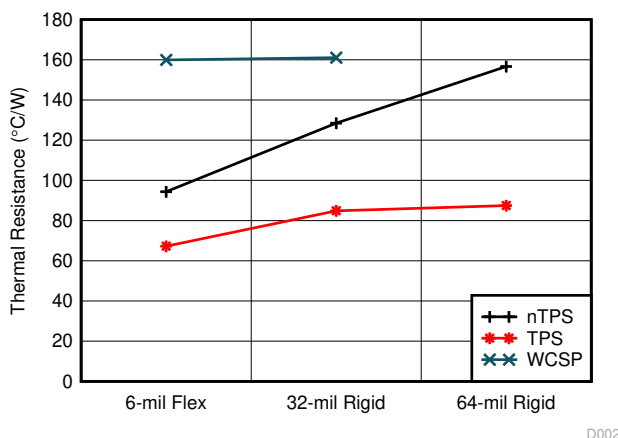
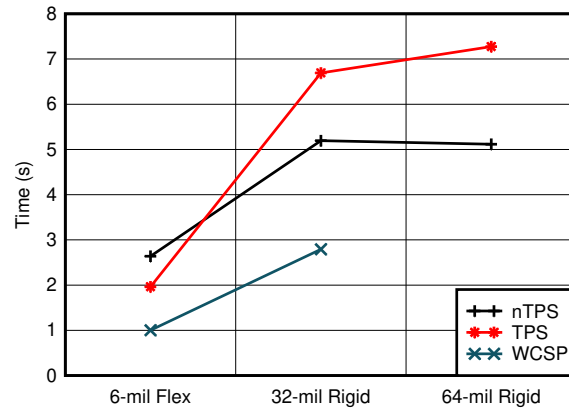

Figure 5-2. Average Calculated Thermal Resistance Between TMP117 and the Measured Object Surface

The following observations come from Figure 5-2:

- **Devices in WCSP BGA package:** The WCSP CBs have the highest thermal resistance (RT), around 160°C/W. As shown in the TMP117 data sheet, this quantity is attributed to the junction-to-board thermal resistance of the package. In WCSP parts, most thermal resistance comes from the WCSP-PCB contacts, and PCB thermal resistance has negligible influence.
- **Devices in QFN package, with thermal pad (TP) soldered:** The QFN packaged devices with soldered TPs (TPS) have the smallest thermal resistance, around 70-80°C/W. According to the TMP117 data sheet, 35°C/W of this is attributed to the junction-to-board thermal resistance of the package.

- **Effect of PCB Thickness:** The thermal resistance increases as PCB thickness increases, which is expected. This effect becomes more noticeable when the TP of the QFN package is not soldered.



D003

Figure 5-3. Sensor Settling Time to 95% of Final Settled Temperature Level vs CB Thickness

The following observations come from [Figure 5-3](#):

- **Devices in WCSP BGA package:** The settling time for WCSP parts is the smallest, typically 1-3 seconds, despite WCSP parts having the highest thermal resistance.
- **Devices in QFN package, with thermal pad (TP) soldered:** The QFN packaged parts with soldered TPs have the longest settling time. This is likely due to the increase in thermal mass by the soldering material now connected to the TPs.
- **Effect of Soldering:** QFN packaged parts with soldered TPs on rigid coupon board typically show an increased 30% in settling time versus non-soldered TP (nTPS).

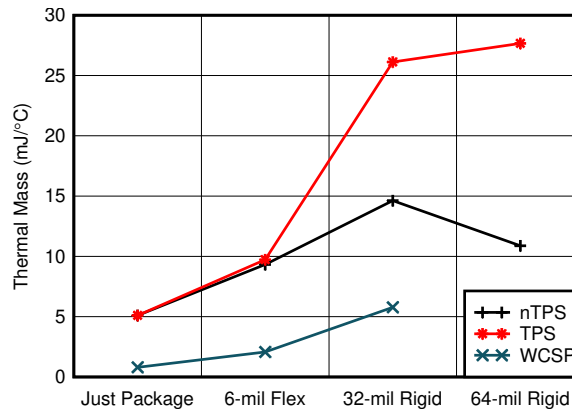

D004

Just Package refers to the package thermal mass stated in the TMP117 device data sheet.

Figure 5-4. Calculated Effective Sensor Thermal Mass vs CB Thickness

The following observations can be inferred from [Figure 5-4](#):

- **Devices in 6-mil Flexible PCB:** The 6-mil flexible coupon board exhibits an effective thermal mass close to the package thermal mass given in the data sheet.
- **Devices in QFN package, with thermal pad (TP) soldered:** The QFN packaged parts with TP soldered to 64-mil thickness coupon board have the highest effective thermal mass, which is 10 times higher than the WCSP BGA packaged parts assembled on flexible coupon board.

[Table 5-1](#) shows all results across the different tests and calculations are summarized. Note that the WCSP-6 (YBG) has a package thermal mass of 1mJ/C, and the QFN/WSON (DRV) package has 5mJ/C:

Table 5-1. Test Results

Package	TP Soldered	PCB	Effective Thermal Mass (mJ/°C)	Thermal Resistance (°C/W)	95% Thermal Response Time (sec)	15 sec Self-Heat Temp Offset (°C)
WCSP-6 /BGA (YBG)		6-mil Flex	2	160	1	0.9
		32-mil Rigid	6	160	2.8	0.9
WSON /QFN-6 (DRV)	Yes	6-mil Flex	9	62	2	0.38
		32-mil Rigid	26	82	6.8	0.59
		64-mil Rigid	27	83	7.2	0.57
	No	6-mil Flex	9	82	2.7	0.51
		32-mil Rigid	14	125	5.1	0.68
		64-mil Rigid	12	148	5.1	0.87

6 Summary

- **Devices in WCSP BGA package on a Flexible PCB:** WCSP parts on flexible PCB exhibit the fastest settling times. However, due to high thermal resistance to the object surface, any temperature leakage to the air can cause significant temperature offset. To counteract this, protection technologies such as thermal isolating foam are highly recommended. This foam should not increase the sensor's thermal mass. Designers should also address the challenge of contact between the flexible PCB and the measured surface. This design is not recommended for noisy temperature environments as temperature fluctuations will easily affect the sensor readings. For detailed precautions to minimize self-heating, see the [Precise Temperature Measurements With the TMP116 and TMP117](#), application note.
- **Devices in QFN package, with thermal pad (TP) soldered:** QFN packaged parts with soldered thermal pads demonstrate the lowest temperature resistance and highest thermal mass. However, this design cannot be widely recommended because soldering the QFN package thermal pad can create additional stress on the silicon die, potentially leading to a temperature offset of up to $\pm 100\text{m}^\circ\text{C}$. System calibration is highly recommended if the design requires the soldering of the QFN package's thermal pad. For more details, refer to the [Precise Temperature Measurements With the TMP116 and TMP117](#), application note.
- **Devices in QFN package, with NO thermal pad soldered (nTPS):** QFN parts on rigid PCB with non-soldered thermal pads are the most common application case. By varying PCB thickness, users can adjust the effective thermal mass, which can act as a temperature fluctuation filter and reduce the need for data averaging inside the sensor. Using thermal isolating foam to reduce leakage to the surrounding air is also highly recommended, if possible.

By understanding these conclusions, designers can make informed decisions to optimize thermal response and measurement accuracy in various applications.

7 References

- Texas Instruments, [Precise Temperature Measurements With the TMP116 and TMP117](#), application note.
- Texas Instruments, [TMP117 High-Accuracy, Low-Power, Digital Temperature Sensor With SMBus™ and I²C-Compatible Interface](#), data sheet.

8 Revision History

Changes from Revision * (September 2024) to Revision A (October 2024)	Page
• Updated the numbering format for tables, figures, and cross-references throughout the document.....	1
• Changed document title from <i>Analyzing Thermal Response in High-Accuracy Temperature Sensors</i> to <i>Analyzing PCB Thermal Resistance in High-Accuracy Temperature Sensors</i>	1

IMPORTANT NOTICE AND DISCLAIMER

TI PROVIDES TECHNICAL AND RELIABILITY DATA (INCLUDING DATA SHEETS), DESIGN RESOURCES (INCLUDING REFERENCE DESIGNS), APPLICATION OR OTHER DESIGN ADVICE, WEB TOOLS, SAFETY INFORMATION, AND OTHER RESOURCES "AS IS" AND WITH ALL FAULTS, AND DISCLAIMS ALL WARRANTIES, EXPRESS AND IMPLIED, INCLUDING WITHOUT LIMITATION ANY IMPLIED WARRANTIES OF MERCHANTABILITY, FITNESS FOR A PARTICULAR PURPOSE OR NON-INFRINGEMENT OF THIRD PARTY INTELLECTUAL PROPERTY RIGHTS.

These resources are intended for skilled developers designing with TI products. You are solely responsible for (1) selecting the appropriate TI products for your application, (2) designing, validating and testing your application, and (3) ensuring your application meets applicable standards, and any other safety, security, regulatory or other requirements.

These resources are subject to change without notice. TI grants you permission to use these resources only for development of an application that uses the TI products described in the resource. Other reproduction and display of these resources is prohibited. No license is granted to any other TI intellectual property right or to any third party intellectual property right. TI disclaims responsibility for, and you will fully indemnify TI and its representatives against, any claims, damages, costs, losses, and liabilities arising out of your use of these resources.

TI's products are provided subject to [TI's Terms of Sale](#) or other applicable terms available either on [ti.com](https://www.ti.com) or provided in conjunction with such TI products. TI's provision of these resources does not expand or otherwise alter TI's applicable warranties or warranty disclaimers for TI products.

TI objects to and rejects any additional or different terms you may have proposed.

Mailing Address: Texas Instruments, Post Office Box 655303, Dallas, Texas 75265
Copyright © 2024, Texas Instruments Incorporated