Ground Shifting in Capacitive Sensing Applications

Rachel Liao

ABSTRACT

Proximity sensing is a key feature in many smart applications. This feature is used for system wake-up, collision avoidance, and gesture recognition. Capacitive sensing solutions are typically implemented to achieve simple yet robust proximity detection. This application note reviews important system considerations when designing with Texas Instruments' resonator-based capacitive sensing chips, the FDC2x1y family. Guidelines for sensor system design and grounding techniques are provided through mathematical modeling and qualitative assessment of external parasitic capacitance.

Contents

1	Introduction	2
2	Mathematical Modeling	2
3	Qualitative Test Setup.....	5
4	Conclusion	10

Trademarks

All trademarks are the property of their respective owners.

1 Introduction

Proximity detection applications that use capacitive sensing have common system challenges which include sensitivity, responsiveness, and power. For example, high sensitivity and a large sensing range are related to the sensor size (SNOA940). A larger sensor size achieves higher sensitivity but more external noise couples into the system, which degrades the signal-to-noise ratio (SNR). An SNR of 6 dB or more produces solid results when processed with the proper algorithms. These tradeoffs are examined in more detail further in this application note. In end-equipment such as automotive applications, white goods, and personal electronics, the capacitive measurements can be affected by whether or not there are nearby grounded objects adjacent to the device. In the following sections this phenomenon, referred to as a ground shift, is further illustrated under the testing conditions that use various ground configurations. These ground configurations are summarized in the following analytical models.

2 Mathematical Modeling

The reason for this ground shift phenomenon is explained by looking at the capacitance models of the system. Figure 1 shows a simple diagram of the FDC2214 and its capacitances. In this model, both the sensor and the system are referenced to earth ground where:

- C_0 is the tank capacitance
- C_s is the sensor capacitance
- L_0 is the tank inductance

The oscillator signal alternates between INA and INB, so the circuit configuration is different for each half cycle of the oscillation.

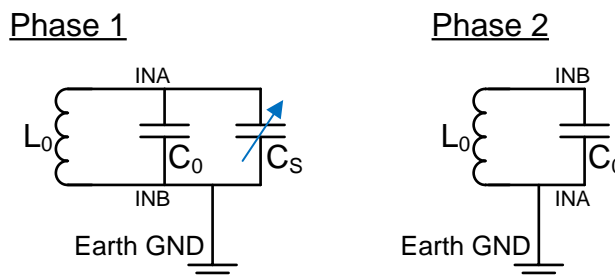

Figure 1. Simplified Model of the FDC2214 EVM Board Referenced to Earth Ground Without a Large Local Ground Plane

Use Equation 1, Equation 2, and Equation 3 for this configuration:

In Phase 1:

$$T_1 = \pi \sqrt{L_0(C_0 + C_s)} = \pi \sqrt{L_0 C_0 \left(1 + \frac{C_s}{C_0}\right)} \tag{1}$$

In Phase 2:

$$T_2 = \pi \sqrt{L_0 C_0} \tag{2}$$

The effective oscillation frequency is the average of the two phases:

$$f = \frac{1}{T_1 + T_2} = \frac{1}{\pi \sqrt{L_0 C_0} \left(1 + \sqrt{1 + \frac{C_s}{C_0}}\right)} \tag{3}$$

These equations show that if the entire system is referenced to earth ground, because L_0 and C_0 are fixed, the sensor frequency is only affected by variations in C_s , as intended.

A second possible ground configuration is represented by a system that is not referenced to earth ground, but instead is isolated and uses a local ground. This is shown in Figure 2, where:

- C_g is the parasitic capacitance between local and earth ground

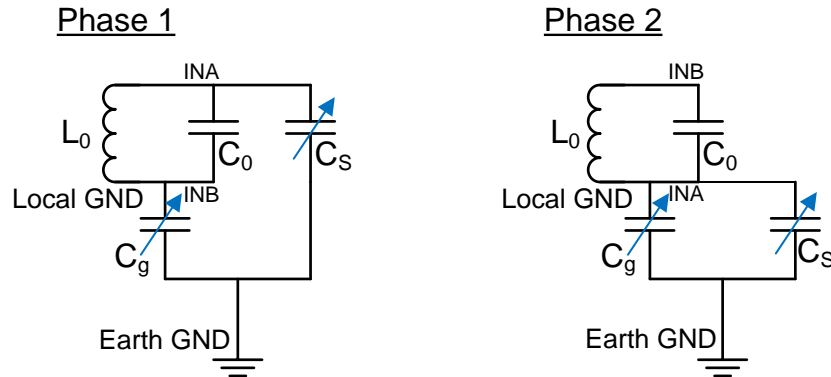

Figure 2. Simplified Model of the FDC2214 EVM Board Floating Without a Large Local Ground Plane

Figure 2 shows how the LC resonator interfaces with earth ground through the parasitic and sensor capacitances of C_s and C_g . In addition to the desired sensor capacitance, C_s , the secondary capacitance, C_g , acts as a sensor also, and is affected by the same objects that interact with the intended sensor, C_s .

Because no other branch bridges the circuit with earth ground in either phase of the half-sine wave excitation, C_s and C_g are effectively in series when referenced to local ground. This series relationship is given by C_x characterized by Equation 4:

$$C_x = \frac{C_g C_s}{C_g + C_s} = \beta C_s \quad (4)$$

where:

$$\beta = \frac{1}{1 + \frac{C_s}{C_g}} \quad (5)$$

This additional C_g creates the above β factor which reworks the equations to the following:

$$T_1 = \pi \sqrt{L_0 (C_0 + C_x)} = \pi \sqrt{L_0 (C_0 + \beta C_s)} = \pi \sqrt{L_0 C_0 \left(1 + \frac{\beta C_s}{C_0}\right)} \quad (6)$$

$$T_2 = \pi \sqrt{L_0 C_0} \quad (7)$$

$$f = \frac{1}{\pi \sqrt{L_0 C_0} \left(1 + \sqrt{1 + \frac{\beta C_s}{C_0}}\right)} \quad (8)$$

In order for these equations to match those that characterize the ideal scenario of Figure 1, β should be as close to 1 as possible which means that C_g should be as large as possible. When the entire system is referenced to earth ground, C_g is theoretically infinite which forces β to be 1 and explains why the ground shift phenomenon is not observed. On the other hand, if C_g is not large enough, β will not be equal to 1 and will cause a shift in the frequency, which appears as a ground shift.

The next sections of this applications note will examine several possible ground configurations. To support the discussion, the reference system will be the FDC2214 EVM connected to a laptop through a USB cable.

2.1 Different Grounding Configurations

System ground configurations are differentiated by their use of either earth ground or local ground. For example, if the sensor PCB is connected to a battery and has no other connections to the external world, the observed performance is different than that of a system referenced to earth ground when parasitic capacitances are introduced. The location and size of the ground reference also makes a difference.

2.1.1 Earth Ground Referenced

When the laptop is referenced to earth ground and powering the EVM through the laptop's USB port, it is also referenced to earth ground. In this scenario, the ground shift phenomenon should not be observed since the laptop will not be able to act as a sensor under these conditions.

Figure 1 shows the system configuration when the laptop is referenced to earth ground. As demonstrated earlier in Equation 1 to Equation 3, when C_g is large, the β -factor becomes close to 1 which prevents a shift in frequency minimizing the ground shift phenomenon.

2.1.2 Floating Ground Referenced

When the laptop is running on battery, it is isolated from earth ground. Because the EVM is powered through the laptop's USB port, it is also isolated from earth ground. In this scenario, the physical separation of the sensor board (EVM), with small local ground, from the power source, with larger local ground, causes the laptop to also act as a sensor under certain conditions.

Figure 2 shows the system configuration when the laptop is floating and battery-powered. As demonstrated in Equation 6 to Equation 8, when C_g is small, the β -factor becomes small which creates a shift in frequency leading to the ground shift phenomenon.

2.1.2.1 Large Local Ground Plane

A way of compensating for this ground shift is to increase C_g by introducing a large local ground plane. The ground plane needs to be large in order to increase the effective C_g . Figure 3 shows the system configuration when the laptop is floating and battery-powered but there is a large ground plane that is connected to the local ground of the FDC2214 EVM through a short wire where:

- C_{pg} is the fixed parasitic capacitance between the large local ground plane and earth ground
- C_{p0} is the fixed parasitic capacitance introduced by the large local ground plane

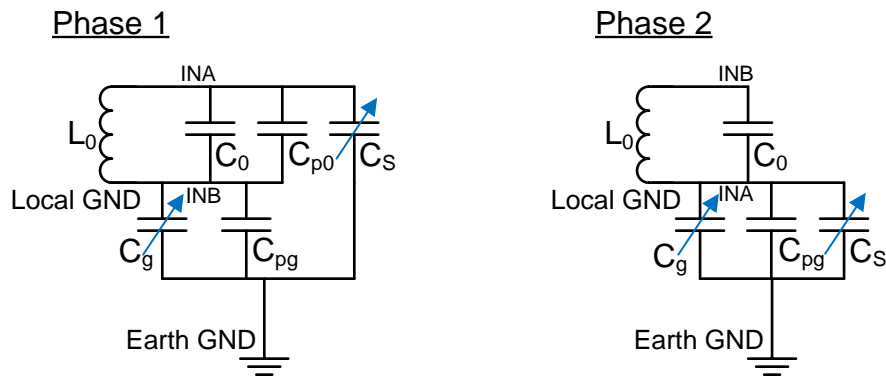

Figure 3. Simplified Model of the FDC2214 EVM Board Floating With a Large Local Ground Plane Nearby

In this configuration, C_{pg} and C_g are in parallel which effectively increases the overall capacitance between local and earth ground. Because C_g effectively increases, β also increases closer to 1 which helps mitigate the ground shift effect.

NOTE: C_{p0} and C_0 are also in parallel which effectively increases the resonator's total capacitance.

Due to this increased capacitance, the signal seen at C_s will become diluted and the sensitivity of the system will decrease. However, this also means that the observed ground shift effect is slightly minimized:

$$T_1 = \pi \sqrt{L_0 (C_0 + C_{p0} + \beta C_s)} \quad (9)$$

$$T_2 = \pi \sqrt{L_0 C_0} \quad (10)$$

$$f = \frac{1}{\pi\sqrt{L_0(C_0 + C_{p0} + \beta C_s)} + \pi\sqrt{L_0 C_0}} \quad (11)$$

For example, if C_{p0} is 10 times larger than C_0 , then the oscillation frequency equation becomes as follows

$$f = \frac{1}{\pi\sqrt{L_0(11C_0 + \beta C_s)} + \pi\sqrt{L_0 C_0}} \quad (12)$$

where changes in βC_s , the series combination of $(C_{gl} | C_{pg})$ and C_s , will have less of an effect on the oscillation frequency than if there was no large nearby ground plane. However, this is more of a second-order effect – the ground shift phenomenon is more directly dependent on how large the effective C_g is.

3 Qualitative Test Setup

This next section, [Section 3](#), presents experiments that qualitatively illustrate the ground shift phenomenon. [Figure 4](#) shows the test setup consisting of an FDC2214 EVM with the standard sensors replaced by a custom bezel-shaped sensor, a USB cable, and a laptop. The FDC2214 EVM is connected to the laptop through the USB (for power and data streaming) and various system grounding configurations are tested to illustrate the ground shift phenomenon. [Table 1](#) shows the device configurations. [Figure 4](#) and [Figure 5](#) show the test measurement setup. The customized bezel sensor area is 55.8 cm² and all proximity detections are measured with a hand approaching within 10 cm of the sensor.

Table 1. Testing Conditions and Device Configuration Settings

	CH0
Proximity Detection	10 cm
Deglintch Filter	10 MHz
Sensor Frequency	4 to 5 MHz
Measurement Sequence	Continuous Single Channel
External Reference Frequency	40 MHz
RCOUNT	65535
IDRIVE	196 μ A

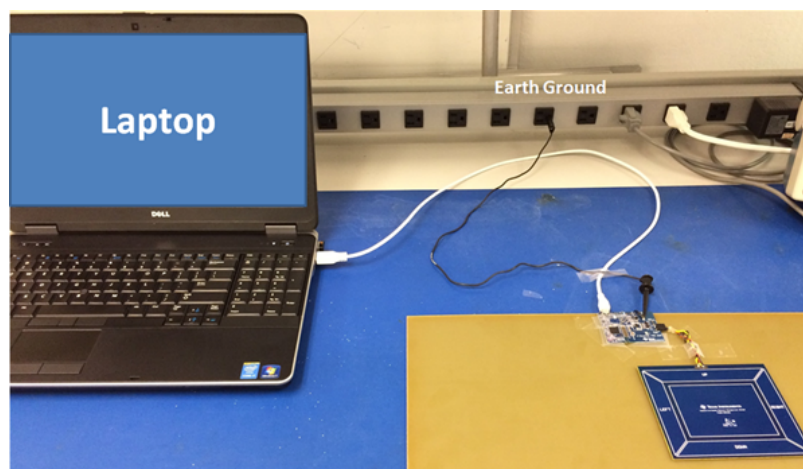

Figure 4. Test Setup: an Outlet Connects to Earth Ground When Needed and a Large Local Ground Plane is Nearby for Connection When Needed

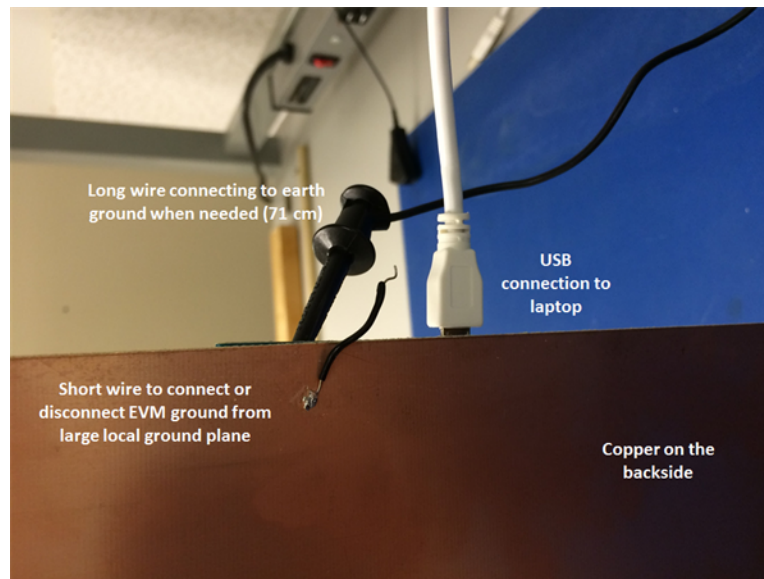

Figure 5. The Ground Plate Has Copper on the Backside (Seen Here) and FR-4 on the Topside (Seen in [Figure 4](#))

The white USB cable connects the FDC2214 EVM directly to the laptop, and the black cable allows the ground of the EVM to connect or disconnect from the ground plane. [Figure 4](#) shows how the long black cable can also connect to earth ground or be left disconnected, leaving the system floating. A short black wire is soldered onto the copper side of the ground plane allowing it to be either connected or disconnected from the FDC2214 EVM ground ([Figure 5](#)).

3.1 *Earth Ground Referenced Laptop*

In this scenario, the laptop is connected to earth ground. Because the FDC2214 EVM is getting its ground from the laptop, that means the reference ground for the FDC device is also at earth ground. [Figure 6](#) shows there is still minor ground shifting when a hand touches the laptop. This is due to the fact that the wire connecting earth ground to the EVM is very long (71 cm) and has its own parasitic capacitance, resistance, and inductance. A shorter wire connecting system ground to earth ground minimizes these parasitics as well as the significance of the ground shift effect.

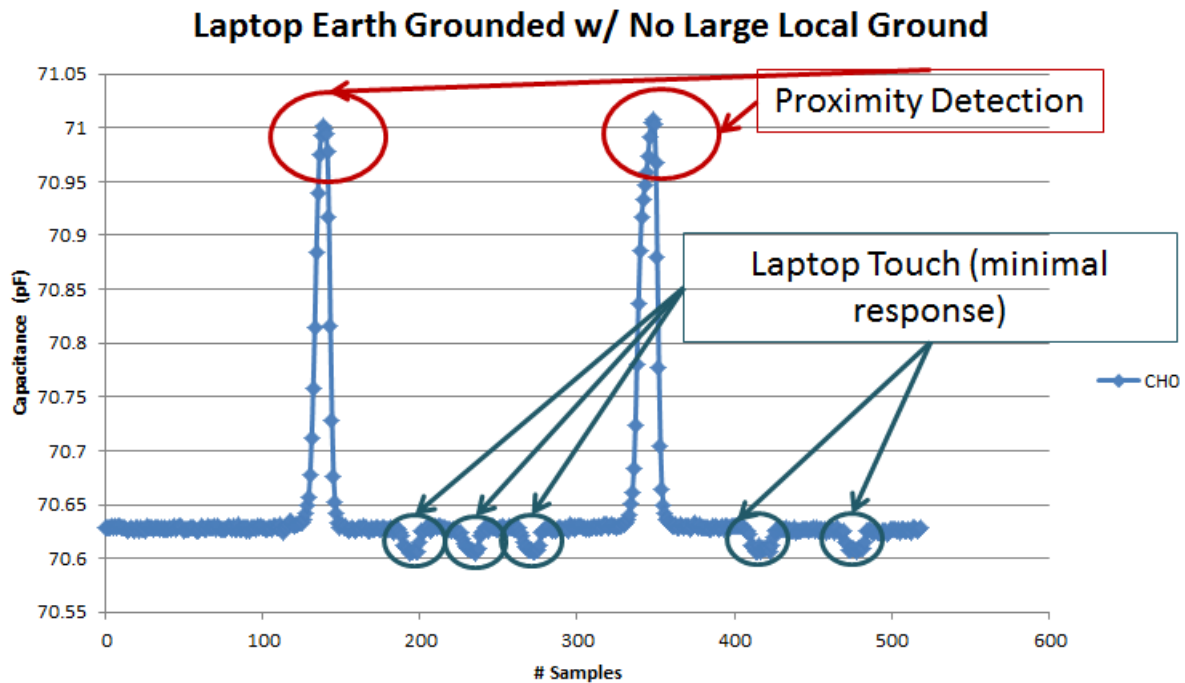

Figure 6. Capacitance Measurements of the System With the Laptop Referenced to Earth Ground and No Nearby Large Local Ground

The total capacitance change of the proximity detection at 10 cm is around 0.37 pF while the total capacitance change for the laptop touch is around 0.02 pF. Because this total capacitance change of the proximity detection is almost twenty times that of the laptop touch and opposite in magnitude, the ground shift does not interfere with proximity detection and can be easily compensated for in the software.

3.2 Floating Laptop

When the EVM is connected to a battery-powered laptop, the system ground is floating at an unknown value relative to earth ground. Because the EVM is getting its ground from the laptop, the reference ground for the FDC device is also floating. When another object, such as the human body, contacts the laptop, the value of ground may shift, causing an apparent shift in the sensor capacitance and a false detection. This setup is shown in [Figure 7](#) and is equivalent to the circuit model shown in [Figure 2](#). The short black wire is not connecting the EVM ground to the large ground plane. Instead, the EVM ground is only connected to the floating laptop ground.

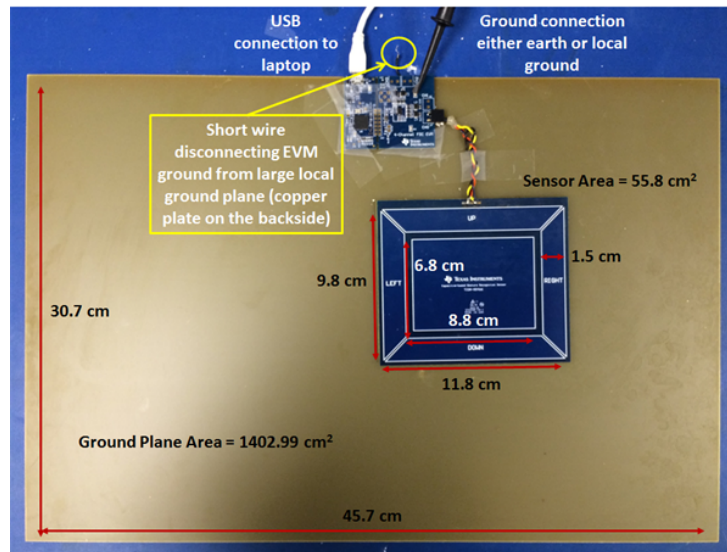

Figure 7. The Setup of the Custom Bezel Sensor, FDC2214 EVM, and Large Local Ground Plane Which is NOT Connected to the EVM and is Left Floating

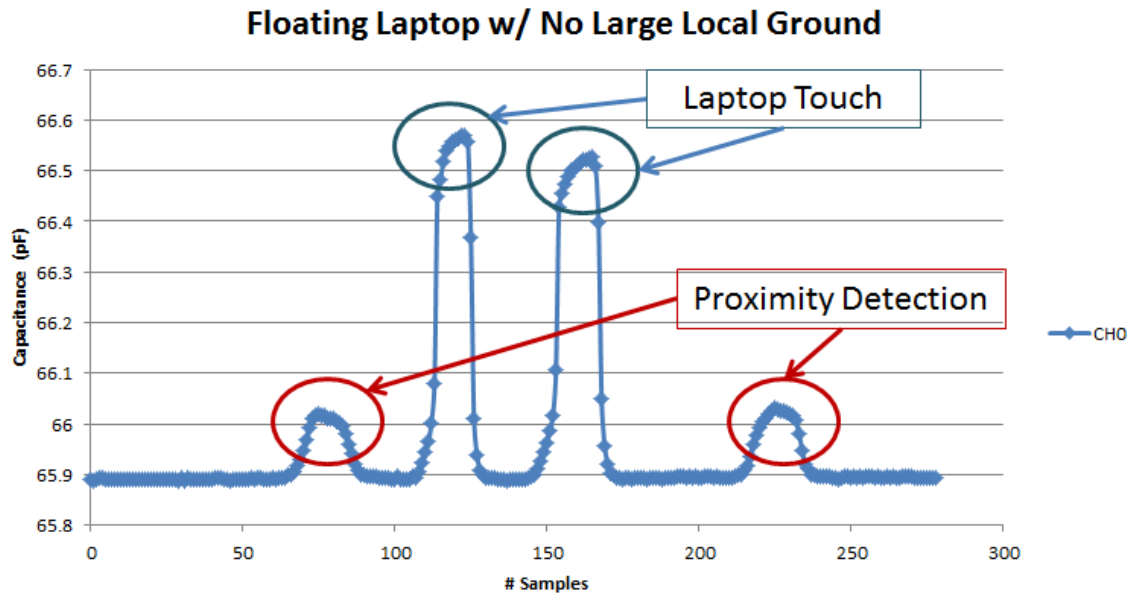

Figure 8. Capacitance Measurements of the System With the Laptop Floating and No Large Local Ground

As expected from the analytical model shown in [Figure 2](#), [Figure 8](#) shows the ground shift phenomenon where the response to a touch of the laptop is much greater than the response to a hand coming within 10 cm of the sensor. Even though the SNR of the proximity detection is already very good, at 16 dB, the laptop touch has an even higher SNR. The total capacitance change of the laptop touch is around 0.60 pF while the total capacitance change for the proximity detection is nearly four times less at around 0.15 pF. These false detections cannot be compensated for in software because the signal signatures are not differentiable.

3.3 Floating Laptop With Large Local Ground Plane

In order to address this, a larger ground plane is introduced near the system as seen in Figure 9. This ground plane is connected to the ground of the EVM via the short black wire circled in yellow. This ground is also connected to the laptop ground. This setup allows for the larger, local ground plane to be at the same potential as the floating ground of both the laptop and the EVM. The reference ground for the FDC device is now set at the local ground and it effectively shields the sensor from any external ground coupling.

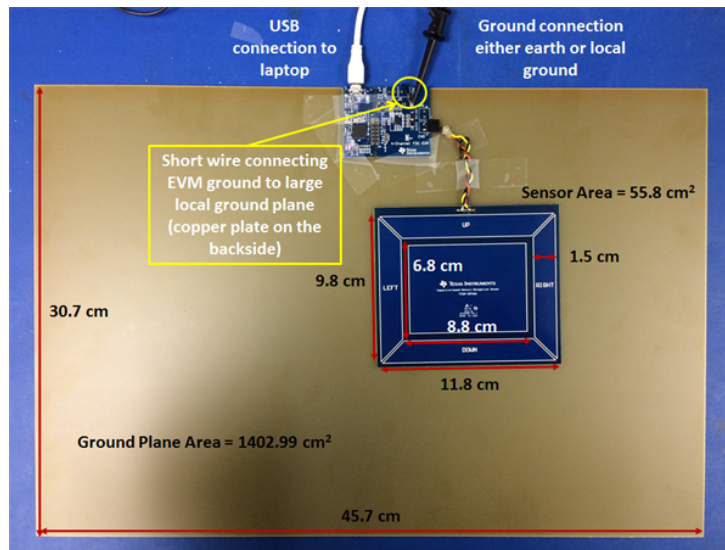

Figure 9. The Setup of the Custom Bezel Sensor, FDC2214 EVM, and Large Local Ground Plane Which IS Connected to the EVM

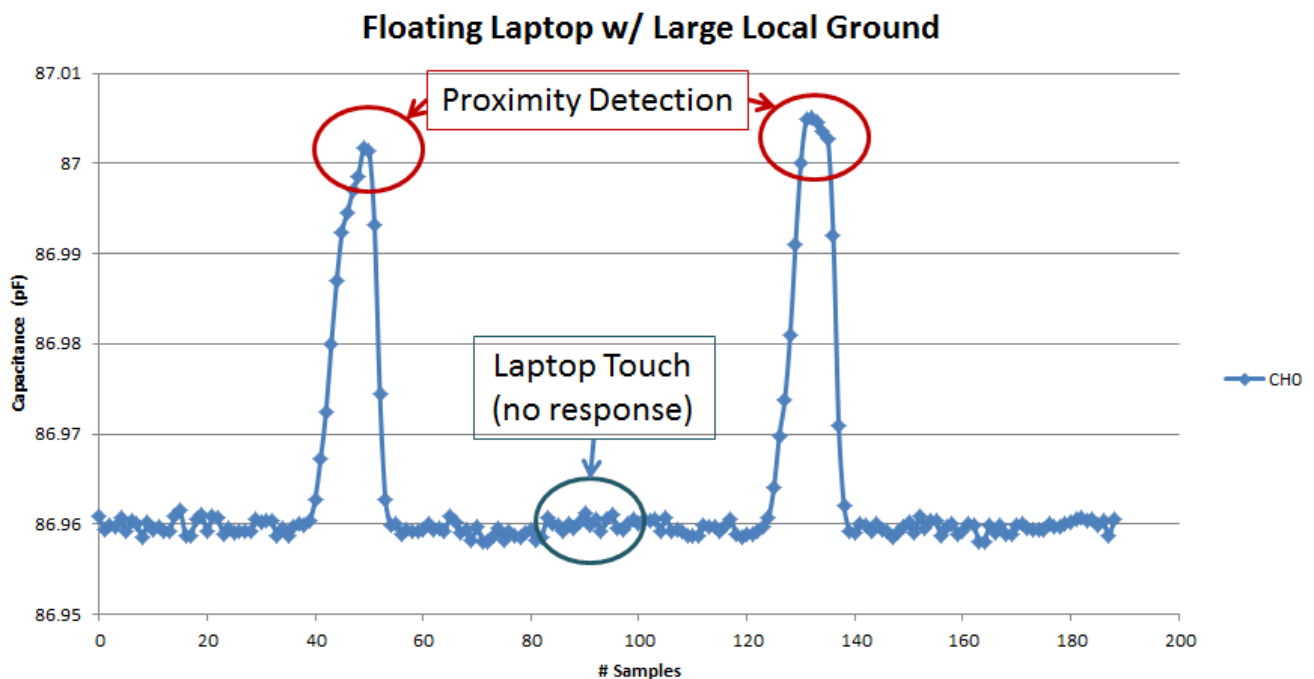

Figure 10. Capacitance Measurements of the System With the Laptop Floating but Also With a Large Local Ground Connected to the EVM

As expected from the circuit model of Figure 3, Figure 10 shows no significant response when the laptop is touched. One thing to note is that the total capacitance change due to proximity detection (10 cm away) decreases and is now at 0.04 pF instead of 0.15 pF. This is due to re-distribution of the electric fields and hence the potential in space – having a large nearby ground will dilute the signal and decrease sensitivity because a large ground parasitic capacitance is introduced (Equation 11). However, even though the sensitivity is reduced, the SNR is still 11 dB. This case illustrates that excess SNR can be traded off for improved immunity to unintended ground shift and false detections, as a result.

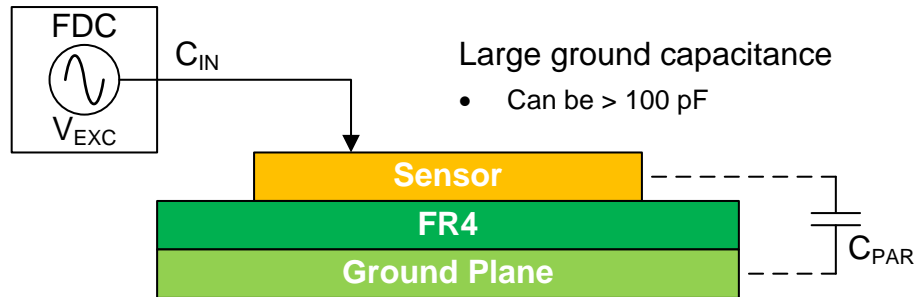

Figure 11. Ground Parasitic Capacitance Between the Ground Plane and the Sensor

This sort of system more closely mimics automotive applications such as kick or door sensors and collision avoidance where the sensors are placed in close proximity to the chassis ground of the car. Because there is a large local ground plane in these applications, the ground shift phenomenon is not an issue although other parameters may need to be changed in order to achieve the required sensitivity; for example, the sensor may need to be larger to achieve the desired sensing range.

4 Conclusion

Achieving the desired system performance for capacitive proximity requires an understanding of appropriate system ground design. The ground shift phenomenon can result in unexpected behavior if not properly addressed in proximity detection applications. This issue resides in the fact that the sensor capacitance is in series with the parasitic capacitance between local and earth ground. If the parasitic capacitance between local and earth ground is small, it can act as a second sensor because it represents a variable ground. This can cause a significant frequency shift which will create false detections. Whenever possible the system ground should be referenced to earth ground using a short connection path. Any minor ground shift effects can be compensated for in the software by differentiating between the signal signatures. If referencing earth ground is not possible, then ensuring that the local ground is large enough to increase C_g can effectively create a more stable ground arrangement and minimize the effect of the shift in ground. The tradeoff with this technique is enabled when there is excess SNR available. However, it is important to note that even with the sensitivity decrease, the grounding configurations with the large ground plane can still produce a solid SNR around 10 dB or more.

IMPORTANT NOTICE FOR TI DESIGN INFORMATION AND RESOURCES

Texas Instruments Incorporated ("TI") technical, application or other design advice, services or information, including, but not limited to, reference designs and materials relating to evaluation modules, (collectively, "TI Resources") are intended to assist designers who are developing applications that incorporate TI products; by downloading, accessing or using any particular TI Resource in any way, you (individually or, if you are acting on behalf of a company, your company) agree to use it solely for this purpose and subject to the terms of this Notice.

TI's provision of TI Resources does not expand or otherwise alter TI's applicable published warranties or warranty disclaimers for TI products, and no additional obligations or liabilities arise from TI providing such TI Resources. TI reserves the right to make corrections, enhancements, improvements and other changes to its TI Resources.

You understand and agree that you remain responsible for using your independent analysis, evaluation and judgment in designing your applications and that you have full and exclusive responsibility to assure the safety of your applications and compliance of your applications (and of all TI products used in or for your applications) with all applicable regulations, laws and other applicable requirements. You represent that, with respect to your applications, you have all the necessary expertise to create and implement safeguards that (1) anticipate dangerous consequences of failures, (2) monitor failures and their consequences, and (3) lessen the likelihood of failures that might cause harm and take appropriate actions. You agree that prior to using or distributing any applications that include TI products, you will thoroughly test such applications and the functionality of such TI products as used in such applications. TI has not conducted any testing other than that specifically described in the published documentation for a particular TI Resource.

You are authorized to use, copy and modify any individual TI Resource only in connection with the development of applications that include the TI product(s) identified in such TI Resource. NO OTHER LICENSE, EXPRESS OR IMPLIED, BY ESTOPPEL OR OTHERWISE TO ANY OTHER TI INTELLECTUAL PROPERTY RIGHT, AND NO LICENSE TO ANY TECHNOLOGY OR INTELLECTUAL PROPERTY RIGHT OF TI OR ANY THIRD PARTY IS GRANTED HEREIN, including but not limited to any patent right, copyright, mask work right, or other intellectual property right relating to any combination, machine, or process in which TI products or services are used. Information regarding or referencing third-party products or services does not constitute a license to use such products or services, or a warranty or endorsement thereof. Use of TI Resources may require a license from a third party under the patents or other intellectual property of the third party, or a license from TI under the patents or other intellectual property of TI.

TI RESOURCES ARE PROVIDED "AS IS" AND WITH ALL FAULTS. TI DISCLAIMS ALL OTHER WARRANTIES OR REPRESENTATIONS, EXPRESS OR IMPLIED, REGARDING TI RESOURCES OR USE THEREOF, INCLUDING BUT NOT LIMITED TO ACCURACY OR COMPLETENESS, TITLE, ANY EPIDEMIC FAILURE WARRANTY AND ANY IMPLIED WARRANTIES OF MERCHANTABILITY, FITNESS FOR A PARTICULAR PURPOSE, AND NON-INFRINGEMENT OF ANY THIRD PARTY INTELLECTUAL PROPERTY RIGHTS.

TI SHALL NOT BE LIABLE FOR AND SHALL NOT DEFEND OR INDEMNIFY YOU AGAINST ANY CLAIM, INCLUDING BUT NOT LIMITED TO ANY INFRINGEMENT CLAIM THAT RELATES TO OR IS BASED ON ANY COMBINATION OF PRODUCTS EVEN IF DESCRIBED IN TI RESOURCES OR OTHERWISE. IN NO EVENT SHALL TI BE LIABLE FOR ANY ACTUAL, DIRECT, SPECIAL, COLLATERAL, INDIRECT, PUNITIVE, INCIDENTAL, CONSEQUENTIAL OR EXEMPLARY DAMAGES IN CONNECTION WITH OR ARISING OUT OF TI RESOURCES OR USE THEREOF, AND REGARDLESS OF WHETHER TI HAS BEEN ADVISED OF THE POSSIBILITY OF SUCH DAMAGES.

You agree to fully indemnify TI and its representatives against any damages, costs, losses, and/or liabilities arising out of your non-compliance with the terms and provisions of this Notice.

This Notice applies to TI Resources. Additional terms apply to the use and purchase of certain types of materials, TI products and services. These include; without limitation, TI's standard terms for semiconductor products (<http://www.ti.com/sc/docs/stdterms.htm>), [evaluation modules](#), and [samples](http://www.ti.com/sc/docs/sampterm.htm) (<http://www.ti.com/sc/docs/sampterm.htm>).

Mailing Address: Texas Instruments, Post Office Box 655303, Dallas, Texas 75265
Copyright © 2018, Texas Instruments Incorporated