

EVM User's Guide: TPS1685EVM

TPS1685 Evaluation Module for eFuse



Description

The TPS1685EVM is used to evaluate the performance of the TPS1685 eFuse device. The TPS1685EVM comes with two TPS16850 eFuses connected in parallel to evaluate a 54V (typical) and 40A (steady state) design. This evaluation module incorporates two TPS16850 devices in parallel, which supports a 2kW input power path protection design at an input voltage of 48V.

Features

- 40V to 60V (typical) operation
- 10A to 44A programmable circuit breaker threshold using onboard jumpers
- Adjustable reference voltage for over-current protection and active current sharing blocks
- undervoltage and overvoltage protections
- Adjustable output voltage slew rate control using onboard jumpers

- Adjustable transient current blanking timer using onboard jumpers
- Adjustable active current sharing threshold using onboard jumpers
- Adjustable scalable fast-trip threshold using onboard jumpers
- TVS diode for input and Schottky diode for output transient protections
- LED status for power good and fault indications
- Options to engage the enable power cycle and the quick output discharge (QOD)

Applications

- Input hotswap and hotplug
- [Server](#) and [high performance computing](#)
- [Network interface cards](#)
- [Graphics and hardware accelerator cards](#)
- [Data center switches](#) and [routers](#)
- Fan trays
- Switches and routers

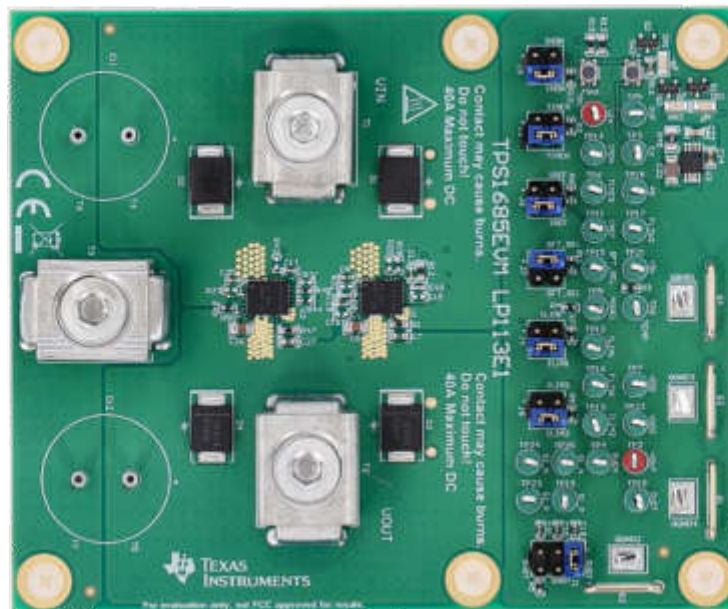

TPS1685EVM

1 Evaluation Module Overview

1.1 Introduction

The TPS1685EVM eFuse Evaluation Board allows reference circuit evaluation of Texas Instruments' TPS1685 eFuse. The TPS1685 device is a 9V to 80V and 20A (RMS) stackable eFuse with an accurate and fast current monitoring capability. This device supports the parallel connection of multiple eFuses for higher current designs by actively synchronizing the device states and sharing the loads during start-up and steady state. The TPS1685 eFuse has an integrated FET with ultra-low ON resistance of 4.3m Ω , adjustable and robust over-current and short-circuit protections, precise load current monitoring, fast adjustable undervoltage and overvoltage protections, adjustable output slew rate control for inrush current protection, and built-in over-temperature protection to verify FET safe operating area (SOA). TPS1685 eFuse also has an adjustable over-current transient blanking timer to support load transients, integrated FET health monitoring, and reporting, analog die temperature monitor output, dedicated fault and power good indication pins.

This user's guide describes the evaluation module (EVM) for the TPS1685 eFuse.



1.2 Kit Contents

Table 1-1. TPS1685EVM: Kit Contents

Item	Description	Quantity
TPS1685EVM	Evaluation module for TPS1685 eFuse	1

1.3 Specification

TPS1685EVM specifications are summarized in [Table 1-2](#).

Table 1-2. TPS1685EVM Design Specifications

PARAMETER	VALUE
Input voltage range (V_{IN})	40V to 60V
Maximum RMS load current ($I_{OUT(max)}$)	40A
Over-current protection threshold (I_{TRIP})	44A
Maximum output capacitance (C_{LOAD})	2mF
Are all the loads off until the PG is asserted?	No
Maximum ambient temperature	70°C
Transient overload blanking timer	17ms
Output voltage slew rate	0.5V/ms
Need to survive a <i>hot-short</i> on output condition?	Yes
Need to survive a <i>power up into short</i> condition?	Yes
Can a board be hot-plugged in or power cycled?	Yes
Load current monitoring needed?	Yes
Fault response	Latch-off

1.4 Device Information

The TPS1685EVM enables the evaluation of TPS16850x and TPS16851x eFuses from TPS1685 family. The input power is applied across the connectors T1 and T3, while T2 and T3 provide the output connection for the EVM, refer to the schematic in [Figure 4-1](#) and EVM test setup in [Figure 3-1](#). TVS diodes D1 and D2 provide the input protection from transient overvoltages. Schottky diodes D3 and D4 protect the output by clamping the negative voltage excursion at the OUT pins of TPS1685 eFuses within the maximum absolute rating.

SW1 allows to do the input power cycle and SW2 enables the quick output discharge (QOD). Power Good (PG) and fault (FLTb1 and amp; FLTb2) indicators are provided by LED DG1, DR1, and DR2 respectively.

Table 1-3. TPS1685EVM eFuse Evaluation Board Options and Setting

EVM Function	Vin UVLO Threshold	Vin OVLO Threshold	ITIMER	Output Slew Rate (dv/dt)	IMON	ILIM	ILIM2	VREF
Performance evaluation of TPS1685, 9V to 80V, 20A eFuse	40V	60V	Selectable - 3ms and 17ms	Selectable - 1V/ms, 0.5V/ms, and 0.1V/ms	Selectable - 25A, and 44A with V _{REF} of 1V	Selectable - 24A and 18A of active current sharing threshold with V _{REF} of 1V	Selectable - 24A and 18A of active current sharing threshold with V _{REF} of 1V	Selectable - 1V and 0.8V

2 Hardware

2.1 General Configurations

2.1.1 Physical Access

The TPS1685EVMeFuse Evaluation Board input and output connectors functionalities are listed in [Table 2-1](#). The availability of test points and the functionalities of the jumpers are described in [Table 2-2](#) and [Table 2-3](#). The function of the signal LED indicators is detailed in [Table 2-4](#).

Table 2-1. Input and Output Connector Functionality

Connector	Label	Description
T1	VIN (+)	Positive terminal for the input power to the EVM
T2	VOUT (+)	Positive terminal for the output power from the EVM
T3	PGND (-)	Negative terminal for the EVM (Common for both input and output)

Table 2-2. Test Points Description

Test Points	Label	Description
TP1	VIN	Input voltage
TP2	VOUT	Output voltage
TP3	EN	Active-high enable input
TP4	SWEN	Open-drain signal to indicate and control power switch ON and OFF status
TP5	OVP	Voltage at the OVP pin of the devices
TP6	TIMER	Overcurrent blanking timer
TP7	VDD1	Controller input power: primary device
TP8	TEMP	Maximum device die temperature monitor analog voltage output with two TPS1685 eFuses in parallel
TP9	MODE1	MODE selection: primary device
TP10	DVDT	Start-up output slew rate control
TP11	IREF	Reference voltage for overcurrent and amp; short-circuit protections, and active current-sharing blocks
TP12	ILIM1	Individual eFuse current monitor and active current sharing threshold under steady-state: primary device
TP13	ILIM2	Individual eFuse current monitor and active current sharing threshold under steady-state: secondary device
TP14	IMON	Load current monitor and over-current and amp; fast-trip thresholds during steady state
TP15	SFT_SEL	Scalable fast trip threshold multiplier during steady state
TP16	FLTb1	Open-drain active low fault indication: primary device
TP17	FLTb2	Open-drain active low fault indication: secondary device
TP18	PG	Open-drain active high power good indication
TP19	S1_P	Kelvin sensing points to measure primary eFuse ON resistance
TP20	S1_N	
TP21	VDD Pullup	5V pullup power supply generated using a LDO from VIN
TP22	VDD2	Controller input power: secondary device
TP23	S2_P	Kelvin sensing points to measure secondary eFuse ON resistance
TP24	S2_N	
QGND1, QGND2, QGND3, and QGND4	QGND	Device ground

Table 2-2. Test Points Description (continued)

Test Points	Label	Description
G1, G2, G3, and G4	QGND	Device ground

Table 2-3. Jumper Descriptions and Default Positions

Jumper	Label	Description	Default Jumper Position
J1	DVDT	1-2 Position sets the output slew rate to 1V/ms	3-4
		3-4 Position sets the output slew rate to 0.5V/ms	
		5-6 Position sets the output slew rate to 0.1V/ms	
J2	TIMER	1-2 Position sets the overcurrent blanking timer to 3ms	3-4
		3-4 Position sets the overcurrent blanking timer to 17ms	
J3	IMON	1-2 Position sets the circuit breaker threshold to 25A with V_{IREF} of 1V	3-4
		3-4 Position sets the circuit breaker threshold to 44A with V_{IREF} of 1V	
J4	ILIM1	1-2 Position sets the active current sharing threshold to 18A with V_{IREF} of 1V: Primary Device	3-4
		3-4 Position sets the active current sharing threshold to 24A with V_{IREF} of 1V: Primary Device	
J5	ILIM2	1-2 Position sets the active current sharing threshold to 18A with V_{IREF} of 1V: Secondary Device	3-4
		3-4 Position sets the active current sharing threshold to 24A with V_{IREF} of 1V: Secondary Device	
J6	IREF	1-2 Position sets the reference voltage for over-current, short-circuit protection, and active current sharing blocks to 0.8V	3-4
		3-4 Position sets the reference voltage for over-current, short-circuit protection, and active current sharing blocks to 1V	
J7	SFT_SEL	1-2 Position sets the scalable fast-trip threshold at 2.5 times over-current threshold	3-4
		3-4 Position sets the scalable fast-trip threshold at 2 times over-current threshold	

Table 2-4. LED Descriptions

LED	Description
DG1	When ON, indicates that PG is asserted
DR1	When ON, indicates that FLTb1 is asserted
DR2	When ON, indicates that FLTb2 is asserted

2.1.2 Test Equipment and Setup

2.1.2.1 Power Supplies

One adjustable power supply with 0V to 80V output and 0A to 100A output current limit.

2.1.2.2 Meters

Two Digital Multi Meters (DMM).

2.1.2.3 Oscilloscope

A DPO2024 or equivalent, three 10x voltage probes, and a DC current probe of 150A rated.

2.1.2.4 Loads

One resistive load or equivalent which can tolerate up to 100A DC load at 80V.

3 Implementation Results

3.1 Test Setup and Procedures

In this user's guide, the test procedure is described for TPS1685 eFuse. Make sure the evaluation board has default jumper settings as shown in [Table 3-1](#).

Table 3-1. Default Jumper Setting for TPS1685EVM eFuse Evaluation Board

J1	J2	J3	J4	J5	J6	J7
3-4	3-4	3-4	3-4	3-4	3-4	3-4

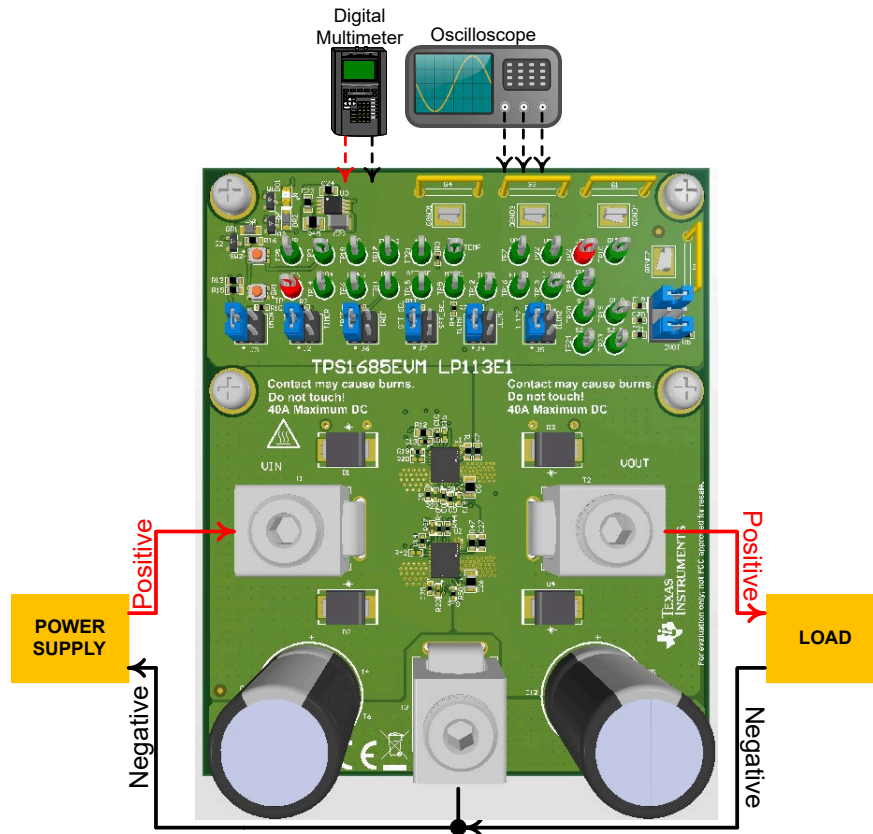

Figure 3-1. TPS1685EVM Setup with Test Equipment

Follow these instructions before starting any test and repeat again before moving to the next test:

- Set the power supply output (VIN) to zero volts.
- Turn off the power supply.
- Adjust the jumper positions on EVM to the default configuration as shown in [Table 3-1](#).
- Turn the power supply on and set the power supply output (VIN) to 54V, 100A, and keep the power supply output disabled.
- Enable the power supply output so that the EVM gets the input power supply.

3.1.1 Hot Plug

Use the following instructions to measure the inrush current during a hot plug event:

1. Configure the jumper J1 position to the desired start-up slew rate as detailed in [Table 2-3](#).
2. Connect a capacitive load of 1mF between VOUT (Connector T2) and PGND (Connector T3).
3. Connect the negative terminal of the power supply to connector T3.
4. Set the input supply voltage VIN to 54V and current limit to 5A. Enable the power supply.
5. Hot plug the positive terminal of the power supply at connector T1.
6. Observe the waveforms at VOUT (TP2) and input current using an oscilloscope to measure the slew rate and rise time of the VOUT with a given input voltage of 54V.

The examples of the hot plug event captured on the TPS1685EVM with two TPS1685 devices in parallel are shown in [Figure 3-2](#).

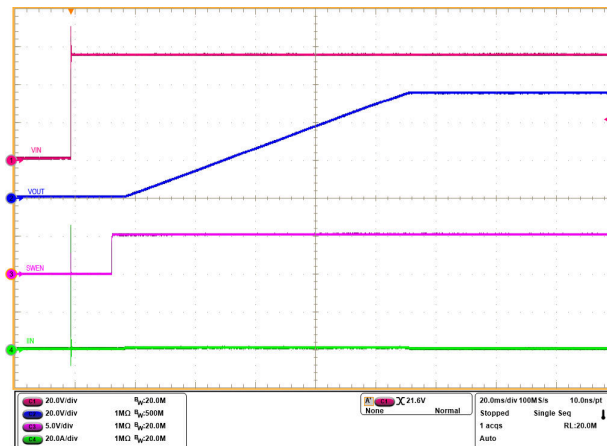

Figure 3-2. TPS1685 eFuse Hot Plug Profile (V_{IN} Stepped Up from 0V to 54V, $C_{OUT} = 1\text{mF}$, and $C_{DVRT} = 82\text{nF}$)

3.1.2 Start-up with Enable

Use the following instructions to power up the TPS1685 eFuse with ENABLE:

1. Configure the jumper J1 position to the desired slew rate as described in [Table 2-3](#).
2. Set the input supply voltage V_{IN} to 54V and current limit to 5A.
3. Connect a capacitive load of 1mF between VOUT (connector T2) and PGND (connector T3).
4. Connect the input supply between V_{IN} (connector T1) and PGND (connector T3).
5. Turn on the power supply by keeping the device disabled using the switch SW1.
6. Enable the eFuses by releasing the switch SW1.
7. Observe the waveform at VOUT (TP2) and input current using an oscilloscope to measure the slew rate and rise time of the VOUT with a given input voltage of 54V.

The start-up profile of TPS1685 eFuse with ENABLE using two devices in parallel is shown in [Figure 3-3](#).

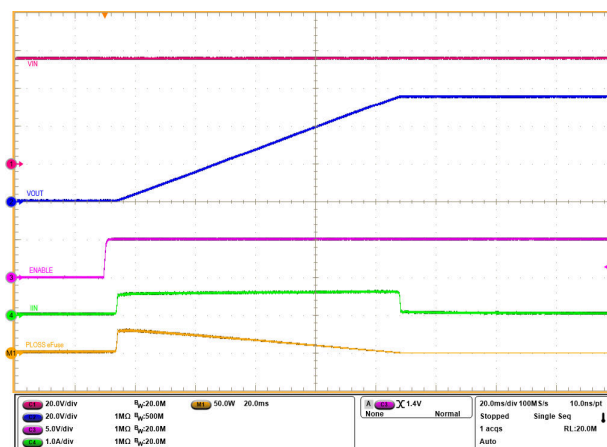

Figure 3-3. TPS1685 eFuse Start-up Profile with ENABLE ($V_{IN} = 54\text{V}$, EN Stepped Up from 0V to 5V, $C_{OUT} = 1\text{mF}$, and $C_{DVRT} = 82\text{nF}$)

3.1.3 Power Up Into Short

Use the following instructions to perform the power-up into short test:

1. Set the input supply voltage V_{IN} to 54V and current limit to 5A. Keep the power supply OFF. Connect the supply between V_{IN} (connector T1) and PGND (connector T3).
2. Short the output of the EVM to ground. For example, V_{OUT} (connector T2) to PGND (connector T3) through a cable.
3. Keep the TPS1685 eFuses disabled by pressing the switch SW1.
4. Turn ON the power supply.
5. Enable the TPS1685 eFuse by releasing the switch SW1.

The test waveforms of power up into output short on the TPS1685EVM with two devices in parallel are shown in Figure 3-4.

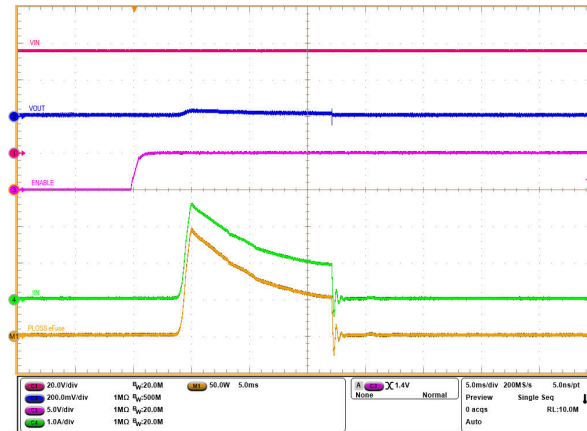

Figure 3-4. Power Up into Output Short Response of TPS1685 eFuse ($V_{IN} = 54V$, EN Stepped Up from 0V to 5V, and OUT Shorted to PGND)

3.1.4 Undervoltage Lockout

Use the following instructions to perform the overvoltage protection test:

1. Set the input supply voltage V_{IN} to 54V and current limit to 5A. Apply the supply between V_{IN} (Connector T1) and PGND (Connector T3) and enable the power supply.
2. Apply a load of 50 Ω between V_{OUT} (connector T2) and PGND (connector T3).
3. Decrease the input supply V_{IN} from 54V to 38V and increase to 54V again, and observe the waveforms using an oscilloscope.

The undervoltage lockout response of TPS1685 eFuse on TPS1685EVM is shown in Figure 3-5.

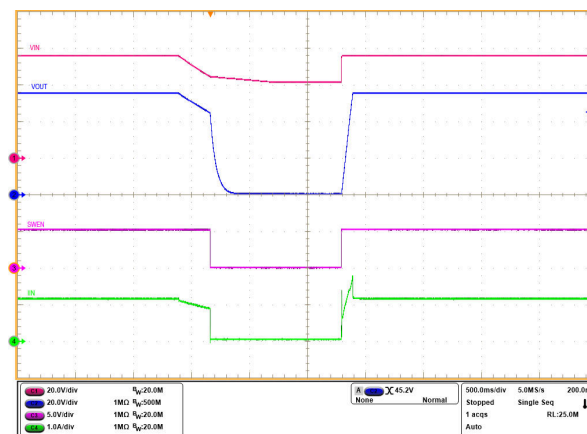

Figure 3-5. Undervoltage Lockout Response of TPS1685 eFuse (V_{IN} Ramped Down from 54V to 38V and Ramped Up to 54V, $V_{IN(UVP)}=40V$, $C_{OUT} = 1mF$, and $R_{LOAD} = 50\Omega$)

3.1.5 Overvoltage Lockout

Use the following instructions to perform the overvoltage protection test:

1. Set the input supply voltage V_{IN} to 54V and current limit to 5A. Apply the supply between V_{IN} (connector T1) and PGND (connector T3) and enable the power supply.
2. Apply a load of 50Ω between V_{OUT} (connector T2) and PGND (connector T3).
3. Increase the input supply V_{IN} from 54V to 62V and decrease to 54V again, and observe the waveforms using an oscilloscope.

The overvoltage lockout response of TPS1685 eFuse on TPS1685EVM is shown in [Figure 3-6](#).

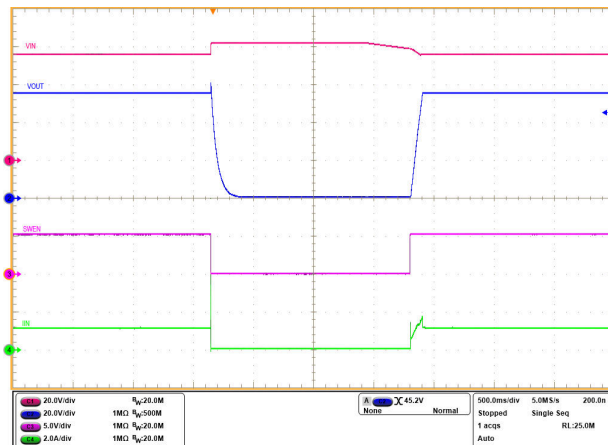

Figure 3-6. Overvoltage Lockout Response of TPS1685 eFuse (V_{IN} Ramped Up from 54V to 62V and Ramped Down to 54V, $V_{IN(OVP)}=60V$, $C_{OUT} = 1mF$, and $R_{LOAD} = 50\Omega$)

3.1.6 Transient Overload Performance

Use the following instructions to observe the transient overload performance:

1. Configure the Jumper J2 to an appropriate position to obtain required over-current blanking period (t_{TIMER}) as per [Table 2-3](#).
2. Configure the Jumper J6 position to desired reference voltage for over-current protection and active current sharing as mentioned in [Table 2-3](#).
3. Configure the Jumper J3 in a good position to set required circuit breaker threshold (I_{OCP}) as per [Table 2-3](#).
4. Configure the Jumper J7 in a good position to set the required scalable fast-trip threshold (I_{SFT}) as per [Table 2-3](#).
5. Set the input supply voltage V_{IN} to 54V and the current limit of 100A.
6. Connect the power supply between V_{IN} (connector T1) and PGND (connector T3) and enable the power supply.
7. Now apply an overload greater than I_{OCP} and less than I_{SFT} between V_{OUT} (connector T2) and PGND (connector T3) for a time duration less than t_{TIMER} decided by using jumper J2.
8. Observe the waveforms using an oscilloscope.

The transient overload performance of TPS1685 eFuse on TPS1685EVM with two devices in parallel is shown in [Figure 3-7](#).

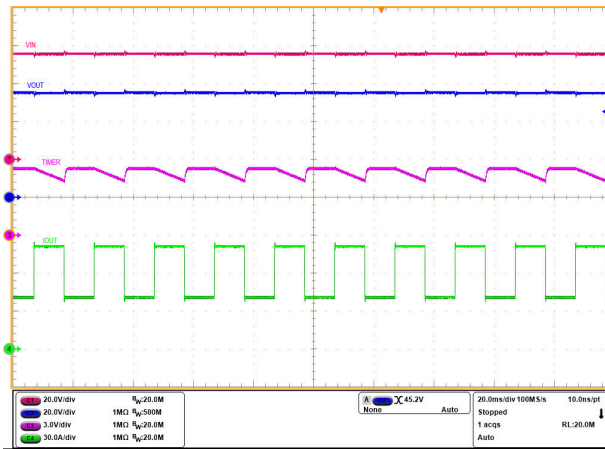

Figure 3-7. Transient Overload Performance of TPS1685 eFuse ($V_{IN} = 54V$, $C_{TIMER} = 27nF$, $C_{OUT} = 1mF$, $R_{IMON} = 1.1k\Omega$ ($I_{OCP} = 50A$), $R_{IREF} = 40.2k\Omega$ ($V_{REF} = 1V$), and I_{OUT} Ramped from 40A for 10ms to 80A for 10ms)

3.1.7 Overcurrent Event

Use the following instructions to perform the persistent over-current test on TPS1685 eFuse:

1. Configure the Jumper J2 to an appropriate position to obtain the required overcurrent blanking period (t_{TIMER}) as per [Table 2-3](#).
2. Configure the Jumper J6 position to the desired reference voltage for overcurrent protection and active current sharing as mentioned in [Table 2-3](#).
3. Configure the Jumper J3 in a good position to set the required circuit breaker threshold (I_{OCP}) as per [Table 2-3](#).
4. Configure the Jumper J7 in a good position to set the required scalable fast-trip threshold (I_{SFT}) as per [Table 2-3](#).
5. Set the input supply voltage V_{IN} to 12V and the current limit of 200A.
6. Connect the power supply between V_{IN} (connector T1) and PGND (connector T3) and enable the power supply.
7. Now apply an overload in the range of I_{OCP} and I_{LOAD} and I_{SFT} between V_{OUT} (connector T2) and PGND (connector T3) for a time duration more than t_{TIMER} decided by using jumper J2.
8. Observe the waveforms using an oscilloscope.

The circuit breaker response of TPS1685 eFuse on TPS1685EVM Evaluation Board with two devices in parallel is shown in [Figure 3-8](#).

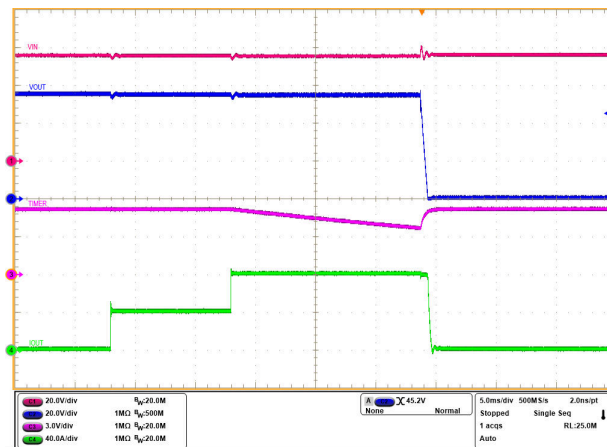

Figure 3-8. Persistent Overload Performance of TPS1685 eFuse ($V_{IN} = 54V$, $C_{TIMER} = 27nF$, $C_{OUT} = 1mF$, $R_{IMON} = 1.1k\Omega$ ($I_{OCP} = 50A$), $R_{IREF} = 40.2k\Omega$ ($V_{REF} = 1V$), and I_{OUT} Ramped from 40A for 10ms to 80A for 20ms)

3.1.8 Output Hot Short

Use the following instructions to perform the output hot short test:

1. Set the input supply voltage V_{IN} to 54V and connect the power supply between V_{IN} (connector T1) and PGND (Connector T3).
2. Configure the Jumper J7 in a good position to set the required scalable fast-trip threshold (I_{SFT}) as per [Table 2-3](#).
3. Turn ON the power supply to power up the EVM.
4. Short the output of the device for example, V_{OUT} (connector T2) to PGND (connector T3) through a short cable.
5. Observe the waveforms using an oscilloscope.

The test waveforms of output hot short on the TPS1685EVM with two TPS1685 eFuses in parallel are shown in [Figure 3-10](#) and [Figure 3-10](#).

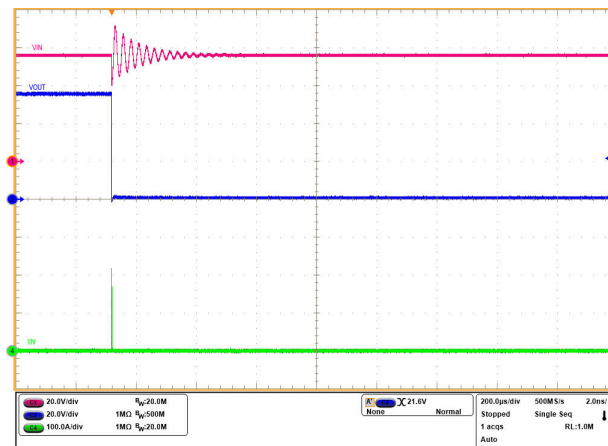

Figure 3-9. Output Hot Short Response (zoomed out) in TPS1685EVM ($V_{IN} = 54V$, $R_{IMON} = 1.1k\Omega$, $R_{IREF} = 40.2k\Omega$, $R_{SFT} = 150k\Omega$, and $C_{OUT} = 1mF$)

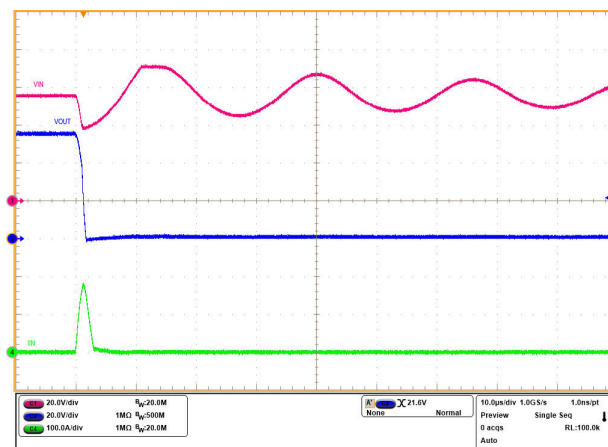

Figure 3-10. Output Hot Short Response (zoomed in) in TPS1685EVM ($V_{IN} = 54V$, $R_{IMON} = 1.1k\Omega$, $R_{IREF} = 40.2k\Omega$, $R_{SFT} = 150k\Omega$, and $C_{OUT} = 1mF$)

Note

Make sure there is sufficient input capacitor to eliminate voltage dips at the input. A combination of electrolytic and ceramic capacitors are preferred. With these capacitors, a large current can be provided for a short period of time during short-circuit.

To obtain repeatable and similar short-circuit testing results is very difficult. The following contributes to the variation in results:

- Source bypassing
- Input leads
- Board layout
- Component selection
- Output shorting method
- Relative location of the short
- Instrumentation

The actual short exhibits a certain degree of randomness because the short microscopically bounces and arcs. Make sure that configuration and methods are used to obtain realistic results. Hence, do not expect to see waveforms exactly like the waveforms in this user's guide because every setup is different.

3.1.9 Quick Output Discharge (QOD)

Use the following instructions to observe the Quick Output Discharge (QOD) functionality:

1. Set the input supply voltage V_{IN} to 54V and current limit to 10A. Turn ON the power supply.
2. Use the switch SW1 to connect the EN/UVLO pin to ground to do power cycling.
3. Use the switch SW2 to enable the QOD by making the voltage at EN/UVLO pin approx. 1.1V.
4. Observe the waveforms of V_{IN} (TP1), V_{OUT} (TP2), EN (TP3), and SWEN (TP4) using an oscilloscope.

The turn-off performance of the TPS1685 eFuse with QOD enabled is shown in [Figure 3-11](#). The turn-off performance with QOD disabled on the TPS1685EVMuse Evaluation Board is shown in [Figure 3-12](#).

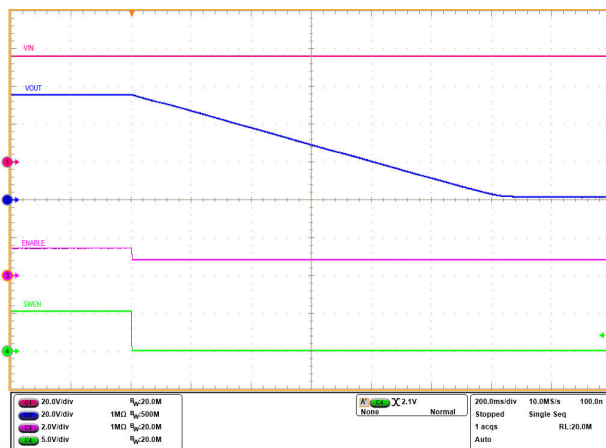

Figure 3-11. QOD Enabled on TPS1685 eFuse ($V_{IN} = 54V$, $C_{OUT} = 1mF$, and EN Pulled Low to 1V)

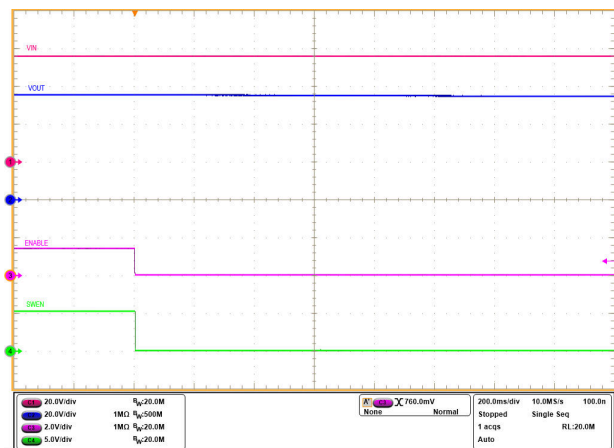

Figure 3-12. QOD Disabled on TPS1685 eFuse ($V_{IN} = 54V$, $C_{OUT} = 1mF$, and EN Pulled Low to 0V)

3.1.10 Thermal Performance of TPS1685EVM

Use the following instructions to evaluate the thermal performance of TPS1685EVM:

1. Configure the Jumper J6 position to desired reference voltage (V_{IREF}) for overcurrent protection and active current sharing as mentioned in [Table 2-3](#). The 3-4 position of the jumper J6 is selected in this experiment, which makes V_{IREF} as 1V (typical).
2. Configure the jumper J3 in a good position to set required circuit breaker threshold (I_{OCP}) as per [Table 2-3](#). The 3-4 position of the jumper J3 is selected in this experiment, which makes I_{OCP} as 44A (typical) with V_{IREF} as 1V (typical).
3. Set the input supply voltage V_{IN} to 54V and current limit of 50A.
4. Connect the power supply between V_{IN} (connector T1) and PGND (connector T3) and enable the power supply.
5. Now apply a load of 40A (DC) between V_{OUT} (connector T2) and PGND (connector T3) for half an hour or more to reach the thermal equilibrium point.
6. Capture the thermal image of the EVM or monitor the voltage at TEMP (TP8) pin using a digital multi-meter. Voltage at the TEMP (V_{TEMP}) pin reports the maximum die temperature between two TPS1685 eFuses, which can be obtained using [Equation 1](#).

$$T_J(^{\circ}C) = \left[25 + \left\{ \frac{V_{TEMP}(mV) - 681}{2.73 (mV/^{\circ}C)} \right\} \right] \quad (1)$$

The thermal performance of TPS1685EVM with two TPS1685 eFuses in parallel is shown in [Figure 3-13](#).

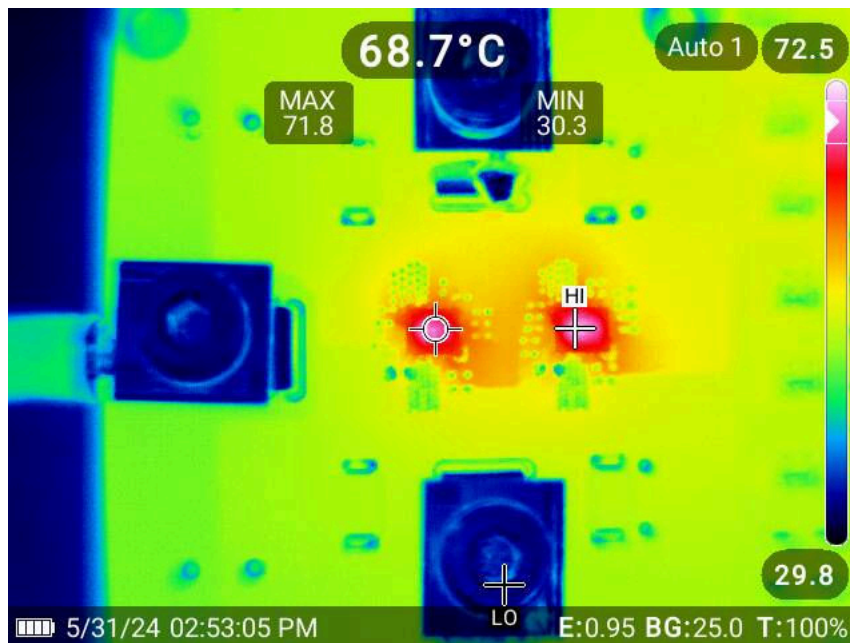

Figure 3-13. Thermal Performance of TPS1685EVM ($V_{IN} = 54V$, $I_{OUT} = 40A$, $T_A = 30^{\circ}C$, and no external air flow)

4 Hardware Design Files

4.1 Schematics

The EVM schematic is shown in Figure 4-1.

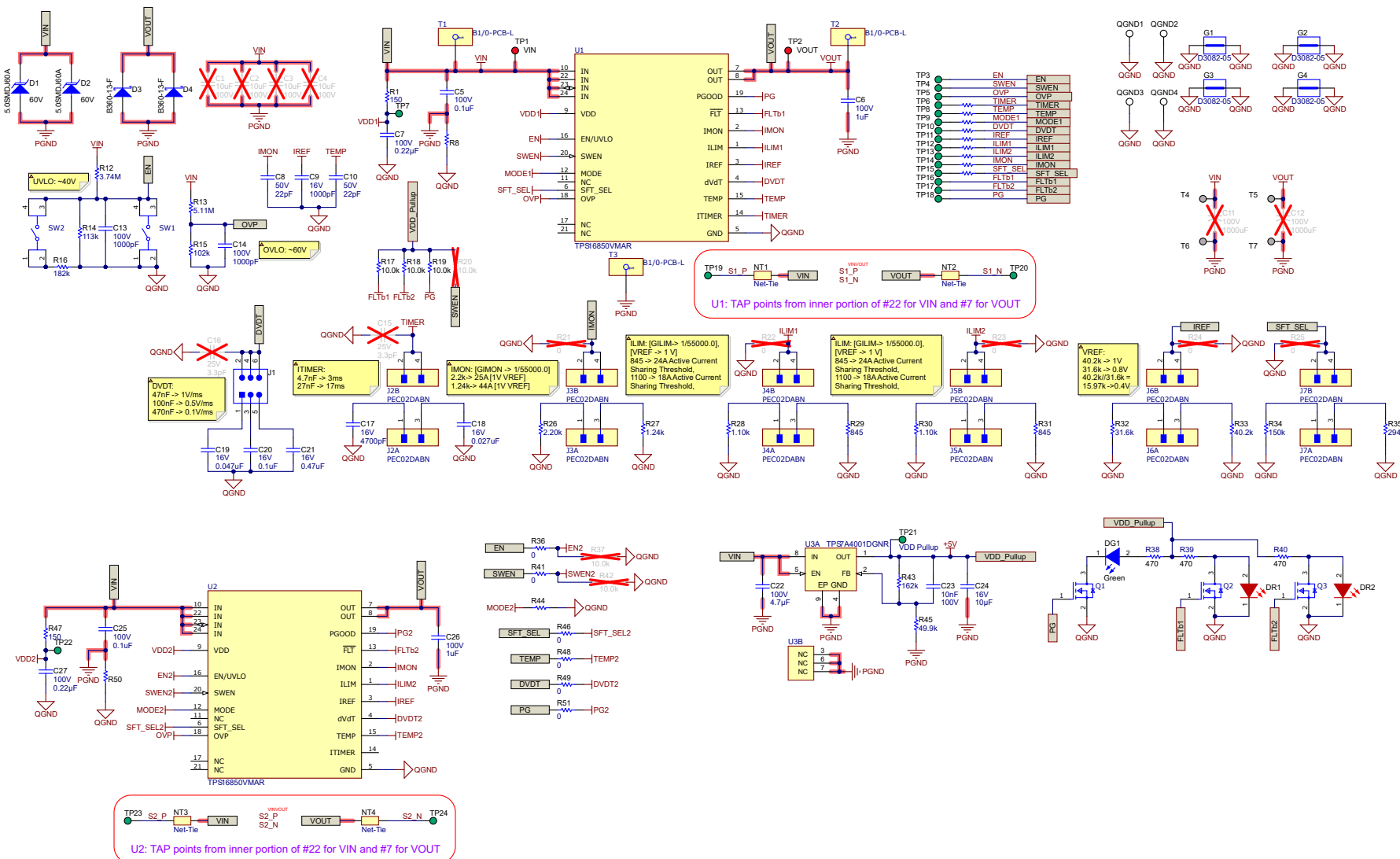

Figure 4-1. TPS1685EVMFuse Evaluation Board Schematic

Note

- To evaluate the performance of one TPS1685 eFuse at lower currents (andlt; 20A), R36, R41, R46, R48, R49, and R51 resistors need to be depopulated, and R37 and R42 resistors must be populated to disable the secondary eFuse.
 - The ground connections for the various components around the TPS1685 eFuses must be wired directly to each other and the GND pins of respective eFuses. This must be followed by connecting them to the system ground at one point, as implemented using R8 and R50 resistors in the EVM schematic. Do not connect the various component grounds through the high current system ground line.
-

4.2 PCB Drawings

The component placements of the EVM are shown in [Figure 4-2](#) and [Figure 4-3](#).

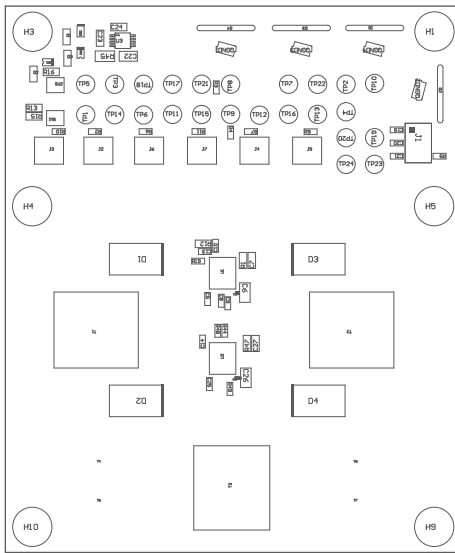

Figure 4-2. TPS1685EVM Board: Top Assembly

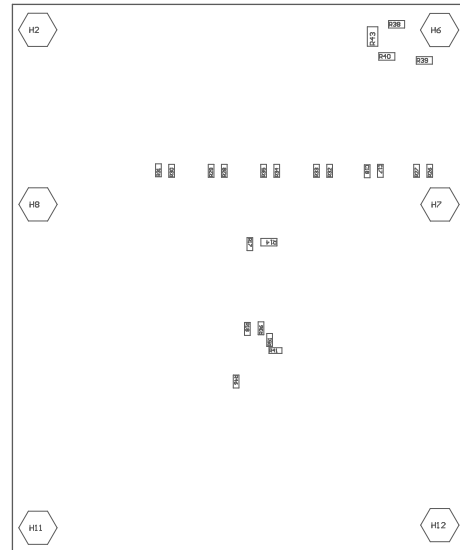

Figure 4-3. TPS1685EVM Board: Bottom Assembly

Note

Analog signal nets, such as IREF, IMON, and TEMP, must be routed away as much as possible from power nets, such as VIN, VOUT, and PGND.

4.3 Bill of Materials (BOM)

The EVM BOM is listed in [Table 4-1](#).

Table 4-1. TPS1685EVM Bill of Materials

Designator	Quantity	Value	Description	Footprint	Part Number	Manufacturer
!PCB1	1		Printed Circuit Board		LP113	Any
C5, C25	2	0.1uF	CAP, CERM, 0.1uF, 100V, +/- 10%, X5R, 0402	0402	GRM155R62A104KE14D	MuRata
C6, C26	2	1uF	CAP, CERM, 1uF, 100V, +/- 10%, X7S, 0805	0805_HV	C2012X7S2A105K125AB	TDK
C7, C27	2	0.22uF	CAP, CERM, 0.22uF, 100V, +/- 10%, X7S, AEC-Q200 Grade 1, 0603	0603	HMK107C7224KAHTE	Taiyo Yuden
C8, C10	2	22pF	CAP, CERM, 22pF, 50V, +/- 1%, C0G/NP0, 0402	0402	GRM1555C1H220FA01D	MuRata
C9	1	1000pF	CAP, CERM, 1000pF, 16V, +/- 10%, X5R, 0402	0402	GRM155R61C102KA01D	MuRata
C13, C14	2	1000pF	CAP, CERM, 1000pF, 100V, +/- 10%, X7R, 0402	0402	GRM155R72A102KA01D	MuRata
C17	1	4700pF	CAP, CERM, 470pF, 16V, +/- 10%, X7R, 0402	0402	GRM155R71C472KA01D	MuRata
C18	1	0.027uF	CAP, CERM, 0.027uF, 16V, +/- 10%, X7R, 0402	0402	GRM155R71C273KA01D	MuRata
C19	1	0.047uF	CAP, CERM, 0.047uF, 16V, +/- 10%, X5R, 0402	0402	GRM155R61C473KA01D	MuRata
C20	1	0.1uF	CAP, CERM, 0.1uF, 16V, +/- 10%, X7R, 0402	0402	GRM155R71C104KA88D	MuRata
C21	1	0.47uF	CAP, CERM, 0.47uF, 16V, +/- 10%, X5R, 0402	0402	GRM155R61C474KE01	MuRata
C22	1	4.7uF	CAP, CERM, 4.7uF, 100V, +/- 20%, X7S, 1206	1206_190	12061Z475MAT2A	AVX
C23	1	0.01uF	CAP, CERM, 0.01uF, 100V, +/- 10%, X7R, 0603	0603	GRM188R72A103KA01D	MuRata
C24	1	10uF	CAP, CERM, 10uF, 16V, +/- 10%, X5R, 0603	0603	GRM188R61C106KAALD	MuRata
D1, D2	2	60V	Diode, TVS, Uni, 60V, 96.8 Vc, SMC	SMC	5.0SMDJ60A	Littelfuse
D3, D4	2	60V	Diode, Schottky, 60V, 3A, SMC	SMC	B360-13-F	Diodes Inc.
DG1	1	Green	LED, Green, SMD	LG_R971_Green	LG R971-KN-1	OSRAM
DR1, DR2	2	Red	LED, Red, SMD	LS_R976_Red	LS R976-NR-1	OSRAM
FID1, FID2, FID3, FID4, FID5, FID6	6		Fiducial mark. There is nothing to buy or mount.	Fiducial10-20	N/A	N/A
G1, G2, G3, G4	4		1mm Uninsulated Shorting Plug, 10.16mm spacing, TH	Harwin_D3082-05	D3082-05	Harwin
H1, H3, H4, H5, H9, H10	6		Machine Screw, Round, #4-40 x 1/4, Nylon, Philips panhead	NY PMS 440 0025 PH	NY PMS 440 0025 PH	Bandamp;F Fastener Supply
H2, H6, H7, H8, H11, H12	6		Standoff, Hex, 0.5"L #4-40 Nylon	Keystone_1902C	1902C	Keystone

Table 4-1. TPS1685EVM Bill of Materials (continued)

Designator	Quantity	Value	Description	Footprint	Part Number	Manufacturer
J1	1		Header, 100mil, 3x2, Tin, TH	SULLINS_PEC03DAAN	PEC03DAAN	Sullins Connector Solutions
J2, J3, J4, J5, J6, J7	6			FP-PEC02DABN_HDR4-MFG	PEC02DABN	Sullins Connector Solutions
Q1, Q2, Q3	3		N-Channel 30V 3.16A (Ta) 750mW (Ta) Surface Mount SOT-23-3 (TO-236)	FP-SI2306BDS-T1-GE3_SOT23-3-MFG	SI2306BDS-T1-GE3	Vishay Siliconix
QGND1, QGND2, QGND3, QGND4	4		Test Point, Compact, SMT	Testpoint_Keystone_Compact	5016	Keystone
R1, R47	2	150	RES, 150, 5%, 0.1 W, AEC-Q200 Grade 0, 0603	0603	CRCW0603150RJNEA	Vishay-Dale
R2, R3, R4, R5, R6, R7, R9, R10, R11	9	1.00k	RES, 1.00 k, 0.1%, 0.063 W, AEC-Q200 Grade 0, 0402	0402	ERA-2APB102X	Panasonic
R8, R50	2		RES SMD 0 OHM JUMPER 1/20W 0201	FP-RC0201JR-070RL_0201 (0603 Metric)-IPC_C	RC0201JR-070RL	Yageo
R12	1	3.74Meg	RES, 3.74M, 1%, 0.1W, AEC-Q200 Grade 0, 0603	0603	CRCW06033M74FKEA	Vishay-Dale
R13	1	5.11Meg	RES, 5.11M, 1%, 0.1W, AEC-Q200 Grade 0, 0603	0603	CRCW06035M11FKEA	Vishay-Dale
R14	1	113k	RES, 113 k, 1%, 0.1 W, 0603	0603	RC0603FR-07113KL	Yageo
R15	1	102k	RES, 102 k, 1%, 0.1 W, AEC-Q200 Grade 0, 0603	0603	CRCW0603102KFKEA	Vishay-Dale
R16	1	182k	RES, 182 k, 1%, 0.1 W, AEC-Q200 Grade 0, 0603	0603	CRCW0603182KFKEA	Vishay-Dale
R17, R18, R19	3	10.0k	RES, 10.0 k, 1%, 0.063 W, 0402	0402	RC0402FR-0710KL	Yageo America
R26	1	2.20k	RES, 2.20 k, 0.1%, 0.0625 W, AEC-Q200 Grade 0, 0402	0402	ERA2AEB222X	Panasonic
R27	1	1.24k	RES, 1.24 k, 0.1%, 0.063 W, AEC-Q200 Grade 0, 0402	0402	ERA2AEB1241X	Panasonic
R28, R30	2	1.10k	RES, 1.10 k, 1%, 0.063 W, AEC-Q200 Grade 0, 0402	0402	CRCW04021K10FKED	Vishay-Dale
R29, R31	2	845	RES, 845, 1%, 0.063 W, AEC-Q200 Grade 0, 0402	0402	CRCW0402845RFKED	Vishay-Dale
R32	1	31.6k	RES, 31.6 k, 1%, 0.063 W, AEC-Q200 Grade 0, 0402	0402	CRCW040231K6FKED	Vishay-Dale
R33	1	40.2k	RES, 40.2 k, 1%, 0.1 W, AEC-Q200 Grade 0, 0402	0402	ERJ-2RKF4022X	Panasonic
R34	1	150k	RES, 150 k, 1%, 0.1 W, AEC-Q200 Grade 0, 0402	0402	ERJ-2RKF1503X	Panasonic
R35	1	294k	RES, 294k, 1%, 0.1 W, 0402	0402	ERJ-2RKF2943X	Panasonic

Table 4-1. TPS1685EVM Bill of Materials (continued)

Designator	Quantity	Value	Description	Footprint	Part Number	Manufacturer
R36, R41, R44, R46, R48, R49, R51	7	0	RES, 0, 5%, 0.063 W, AEC-Q200 Grade 0, 0402	0402	CRCW04020000Z0ED	Vishay-Dale
R38, R39, R40	3	470	RES, 470, 5%, 0.1 W, 0603	0603	RC0603JR-07470RL	Yageo
R43	1	162k	RES, 162 k, 0.1%, 0.125 W, 0805	0805_HV	RT0805BRD07162KL	Yageo America
R45	1	49.9k	RES, 49.9 k, 0.1%, 0.125 W, 0805	0805_HV	RT0805BRD0749K9L	Yageo America
SH1, SH2, SH3, SH4, SH5, SH6, SH7, SH8, SH9, SH10, SH11, SH12	12		Shunt, 2.54mm, Gold, Blue	Würth_60900213621	60900213621	Würth Elektronik
SW1, SW2	2		Tactile Switch SPST-NO Top Actuated Surface Mount	FP-PTS830GM140SMTRLFS_SMT_3MM05_2MM6-MFG	PTS830GM140SMTRLFS	Candamp;K Components
T1, T2, T3	3		1/0 AWG High AMP PCB Wire Lugs 1/0-8 AWG	FP-B1-0-PCB-L_WIRE_LUG_150A_1-0 AWG-MFG	B1/0-PCB-L	INTERNATIONAL HYDRAULICS
T4, T5, T6, T7	4		Connector, Receptacle, Pin, TH	CONN_0300-2-15-01-47-01-10-0	0300-2-15-01-47-01-10-0	Mill-Max
TP1, TP2	2		Test Point, Multipurpose, Red, TH	Keystone5010	5010	Keystone
TP3, TP4, TP5, TP6, TP7, TP8, TP9, TP10, TP11, TP12, TP13, TP14, TP15, TP16, TP17, TP18, TP19, TP20, TP21, TP22, TP23, TP24	22		Test Point, Multipurpose, Green, TH	Keystone5126	5126	Keystone
U1, U2	2		9V - 80V , 4.3mΩ, 20A Stackable eFuse with Accurate andamp; Fast Current Monitor	VMA0023A-MFG	TPS16850VMAR	Texas Instruments
U3	1		Single Output LDO, 50mA, Adjustable 1.175 to 90V Output, 7V to 100V Input, 8-pin MSOP (DGN), -40 to 125 degC, Green (RoHS andamp; no Sb/Br)	DGN0008B_N	TPS7A4001DGNR	Texas Instruments

5 Additional Information

5.1 Trademarks

All trademarks are the property of their respective owners.

STANDARD TERMS FOR EVALUATION MODULES

1. *Delivery:* TI delivers TI evaluation boards, kits, or modules, including any accompanying demonstration software, components, and/or documentation which may be provided together or separately (collectively, an "EVM" or "EVMs") to the User ("User") in accordance with the terms set forth herein. User's acceptance of the EVM is expressly subject to the following terms.
 - 1.1 EVMs are intended solely for product or software developers for use in a research and development setting to facilitate feasibility evaluation, experimentation, or scientific analysis of TI semiconductor products. EVMs have no direct function and are not finished products. EVMs shall not be directly or indirectly assembled as a part or subassembly in any finished product. For clarification, any software or software tools provided with the EVM ("Software") shall not be subject to the terms and conditions set forth herein but rather shall be subject to the applicable terms that accompany such Software
 - 1.2 EVMs are not intended for consumer or household use. EVMs may not be sold, sublicensed, leased, rented, loaned, assigned, or otherwise distributed for commercial purposes by Users, in whole or in part, or used in any finished product or production system.
2. *Limited Warranty and Related Remedies/Disclaimers:*
 - 2.1 These terms do not apply to Software. The warranty, if any, for Software is covered in the applicable Software License Agreement.
 - 2.2 TI warrants that the TI EVM will conform to TI's published specifications for ninety (90) days after the date TI delivers such EVM to User. Notwithstanding the foregoing, TI shall not be liable for a nonconforming EVM if (a) the nonconformity was caused by neglect, misuse or mistreatment by an entity other than TI, including improper installation or testing, or for any EVMs that have been altered or modified in any way by an entity other than TI, (b) the nonconformity resulted from User's design, specifications or instructions for such EVMs or improper system design, or (c) User has not paid on time. Testing and other quality control techniques are used to the extent TI deems necessary. TI does not test all parameters of each EVM. User's claims against TI under this Section 2 are void if User fails to notify TI of any apparent defects in the EVMs within ten (10) business days after delivery, or of any hidden defects with ten (10) business days after the defect has been detected.
 - 2.3 TI's sole liability shall be at its option to repair or replace EVMs that fail to conform to the warranty set forth above, or credit User's account for such EVM. TI's liability under this warranty shall be limited to EVMs that are returned during the warranty period to the address designated by TI and that are determined by TI not to conform to such warranty. If TI elects to repair or replace such EVM, TI shall have a reasonable time to repair such EVM or provide replacements. Repaired EVMs shall be warranted for the remainder of the original warranty period. Replaced EVMs shall be warranted for a new full ninety (90) day warranty period.

WARNING

Evaluation Kits are intended solely for use by technically qualified, professional electronics experts who are familiar with the dangers and application risks associated with handling electrical mechanical components, systems, and subsystems.

User shall operate the Evaluation Kit within TI's recommended guidelines and any applicable legal or environmental requirements as well as reasonable and customary safeguards. Failure to set up and/or operate the Evaluation Kit within TI's recommended guidelines may result in personal injury or death or property damage. Proper set up entails following TI's instructions for electrical ratings of interface circuits such as input, output and electrical loads.

NOTE:

EXPOSURE TO ELECTROSTATIC DISCHARGE (ESD) MAY CAUSE DEGRADATION OR FAILURE OF THE EVALUATION KIT; TI RECOMMENDS STORAGE OF THE EVALUATION KIT IN A PROTECTIVE ESD BAG.

3 Regulatory Notices:

3.1 United States

3.1.1 Notice applicable to EVMs not FCC-Approved:

FCC NOTICE: This kit is designed to allow product developers to evaluate electronic components, circuitry, or software associated with the kit to determine whether to incorporate such items in a finished product and software developers to write software applications for use with the end product. This kit is not a finished product and when assembled may not be resold or otherwise marketed unless all required FCC equipment authorizations are first obtained. Operation is subject to the condition that this product not cause harmful interference to licensed radio stations and that this product accept harmful interference. Unless the assembled kit is designed to operate under part 15, part 18 or part 95 of this chapter, the operator of the kit must operate under the authority of an FCC license holder or must secure an experimental authorization under part 5 of this chapter.

3.1.2 For EVMs annotated as FCC – FEDERAL COMMUNICATIONS COMMISSION Part 15 Compliant:

CAUTION

This device complies with part 15 of the FCC Rules. Operation is subject to the following two conditions: (1) This device may not cause harmful interference, and (2) this device must accept any interference received, including interference that may cause undesired operation.

Changes or modifications not expressly approved by the party responsible for compliance could void the user's authority to operate the equipment.

FCC Interference Statement for Class A EVM devices

NOTE: This equipment has been tested and found to comply with the limits for a Class A digital device, pursuant to part 15 of the FCC Rules. These limits are designed to provide reasonable protection against harmful interference when the equipment is operated in a commercial environment. This equipment generates, uses, and can radiate radio frequency energy and, if not installed and used in accordance with the instruction manual, may cause harmful interference to radio communications. Operation of this equipment in a residential area is likely to cause harmful interference in which case the user will be required to correct the interference at his own expense.

FCC Interference Statement for Class B EVM devices

NOTE: This equipment has been tested and found to comply with the limits for a Class B digital device, pursuant to part 15 of the FCC Rules. These limits are designed to provide reasonable protection against harmful interference in a residential installation. This equipment generates, uses and can radiate radio frequency energy and, if not installed and used in accordance with the instructions, may cause harmful interference to radio communications. However, there is no guarantee that interference will not occur in a particular installation. If this equipment does cause harmful interference to radio or television reception, which can be determined by turning the equipment off and on, the user is encouraged to try to correct the interference by one or more of the following measures:

- Reorient or relocate the receiving antenna.
- Increase the separation between the equipment and receiver.
- Connect the equipment into an outlet on a circuit different from that to which the receiver is connected.
- Consult the dealer or an experienced radio/TV technician for help.

3.2 Canada

3.2.1 For EVMs issued with an Industry Canada Certificate of Conformance to RSS-210 or RSS-247

Concerning EVMs Including Radio Transmitters:

This device complies with Industry Canada license-exempt RSSs. Operation is subject to the following two conditions:

(1) this device may not cause interference, and (2) this device must accept any interference, including interference that may cause undesired operation of the device.

Concernant les EVMs avec appareils radio:

Le présent appareil est conforme aux CNR d'Industrie Canada applicables aux appareils radio exempts de licence. L'exploitation est autorisée aux deux conditions suivantes: (1) l'appareil ne doit pas produire de brouillage, et (2) l'utilisateur de l'appareil doit accepter tout brouillage radioélectrique subi, même si le brouillage est susceptible d'en compromettre le fonctionnement.

Concerning EVMs Including Detachable Antennas:

Under Industry Canada regulations, this radio transmitter may only operate using an antenna of a type and maximum (or lesser) gain approved for the transmitter by Industry Canada. To reduce potential radio interference to other users, the antenna type and its gain should be so chosen that the equivalent isotropically radiated power (e.i.r.p.) is not more than that necessary for successful communication. This radio transmitter has been approved by Industry Canada to operate with the antenna types listed in the user guide with the maximum permissible gain and required antenna impedance for each antenna type indicated. Antenna types not included in this list, having a gain greater than the maximum gain indicated for that type, are strictly prohibited for use with this device.

Concernant les EVMs avec antennes détachables

Conformément à la réglementation d'Industrie Canada, le présent émetteur radio peut fonctionner avec une antenne d'un type et d'un gain maximal (ou inférieur) approuvé pour l'émetteur par Industrie Canada. Dans le but de réduire les risques de brouillage radioélectrique à l'intention des autres utilisateurs, il faut choisir le type d'antenne et son gain de sorte que la puissance isotrope rayonnée équivalente (p.i.r.e.) ne dépasse pas l'intensité nécessaire à l'établissement d'une communication satisfaisante. Le présent émetteur radio a été approuvé par Industrie Canada pour fonctionner avec les types d'antenne énumérés dans le manuel d'usage et ayant un gain admissible maximal et l'impédance requise pour chaque type d'antenne. Les types d'antenne non inclus dans cette liste, ou dont le gain est supérieur au gain maximal indiqué, sont strictement interdits pour l'exploitation de l'émetteur.

3.3 Japan

3.3.1 *Notice for EVMs delivered in Japan:* Please see http://www.tij.co.jp/lstds/ti_ja/general/eStore/notice_01.page 日本国内に輸入される評価用キット、ボードについては、次のところをご覧ください。

<https://www.ti.com/ja-jp/legal/notice-for-evaluation-kits-delivered-in-japan.html>

3.3.2 *Notice for Users of EVMs Considered "Radio Frequency Products" in Japan:* EVMs entering Japan may not be certified by TI as conforming to Technical Regulations of Radio Law of Japan.

If User uses EVMs in Japan, not certified to Technical Regulations of Radio Law of Japan, User is required to follow the instructions set forth by Radio Law of Japan, which includes, but is not limited to, the instructions below with respect to EVMs (which for the avoidance of doubt are stated strictly for convenience and should be verified by User):

1. Use EVMs in a shielded room or any other test facility as defined in the notification #173 issued by Ministry of Internal Affairs and Communications on March 28, 2006, based on Sub-section 1.1 of Article 6 of the Ministry's Rule for Enforcement of Radio Law of Japan,
2. Use EVMs only after User obtains the license of Test Radio Station as provided in Radio Law of Japan with respect to EVMs, or
3. Use of EVMs only after User obtains the Technical Regulations Conformity Certification as provided in Radio Law of Japan with respect to EVMs. Also, do not transfer EVMs, unless User gives the same notice above to the transferee. Please note that if User does not follow the instructions above, User will be subject to penalties of Radio Law of Japan.

【無線電波を送信する製品の開発キットをお使いになる際の注意事項】 開発キットの中には技術基準適合証明を受けていないものがあります。技術適合証明を受けていないものご使用に際しては、電波法遵守のため、以下のいずれかの措置を取っていただく必要がありますのでご注意ください。

1. 電波法施行規則第6条第1項第1号に基づく平成18年3月28日総務省告示第173号で定められた電波暗室等の試験設備でご使用いただく。
2. 実験局の免許を取得後ご使用いただく。
3. 技術基準適合証明を取得後ご使用いただく。

なお、本製品は、上記の「ご使用にあたっての注意」を譲渡先、移転先に通知しない限り、譲渡、移転できないものとします。

上記を遵守頂けない場合は、電波法の罰則が適用される可能性があることをご留意ください。日本テキサス・イ

ンスツルメンツ株式会社

東京都新宿区西新宿 6 丁目 2 4 番 1 号

西新宿三井ビル

3.3.3 *Notice for EVMs for Power Line Communication:* Please see http://www.tij.co.jp/lstds/ti_ja/general/eStore/notice_02.page

電力線搬送波通信についての開発キットをお使いになる際の注意事項については、次のところをご覧ください。 <https://www.ti.com/ja-jp/legal/notice-for-evaluation-kits-for-power-line-communication.html>

3.4 European Union

3.4.1 *For EVMs subject to EU Directive 2014/30/EU (Electromagnetic Compatibility Directive):*

This is a class A product intended for use in environments other than domestic environments that are connected to a low-voltage power-supply network that supplies buildings used for domestic purposes. In a domestic environment this product may cause radio interference in which case the user may be required to take adequate measures.

-
4. *EVM Use Restrictions and Warnings:*
 - 4.1 EVMS ARE NOT FOR USE IN FUNCTIONAL SAFETY AND/OR SAFETY CRITICAL EVALUATIONS, INCLUDING BUT NOT LIMITED TO EVALUATIONS OF LIFE SUPPORT APPLICATIONS.
 - 4.2 User must read and apply the user guide and other available documentation provided by TI regarding the EVM prior to handling or using the EVM, including without limitation any warning or restriction notices. The notices contain important safety information related to, for example, temperatures and voltages.
 - 4.3 *Safety-Related Warnings and Restrictions:*
 - 4.3.1 User shall operate the EVM within TI's recommended specifications and environmental considerations stated in the user guide, other available documentation provided by TI, and any other applicable requirements and employ reasonable and customary safeguards. Exceeding the specified performance ratings and specifications (including but not limited to input and output voltage, current, power, and environmental ranges) for the EVM may cause personal injury or death, or property damage. If there are questions concerning performance ratings and specifications, User should contact a TI field representative prior to connecting interface electronics including input power and intended loads. Any loads applied outside of the specified output range may also result in unintended and/or inaccurate operation and/or possible permanent damage to the EVM and/or interface electronics. Please consult the EVM user guide prior to connecting any load to the EVM output. If there is uncertainty as to the load specification, please contact a TI field representative. During normal operation, even with the inputs and outputs kept within the specified allowable ranges, some circuit components may have elevated case temperatures. These components include but are not limited to linear regulators, switching transistors, pass transistors, current sense resistors, and heat sinks, which can be identified using the information in the associated documentation. When working with the EVM, please be aware that the EVM may become very warm.
 - 4.3.2 EVMs are intended solely for use by technically qualified, professional electronics experts who are familiar with the dangers and application risks associated with handling electrical mechanical components, systems, and subsystems. User assumes all responsibility and liability for proper and safe handling and use of the EVM by User or its employees, affiliates, contractors or designees. User assumes all responsibility and liability to ensure that any interfaces (electronic and/or mechanical) between the EVM and any human body are designed with suitable isolation and means to safely limit accessible leakage currents to minimize the risk of electrical shock hazard. User assumes all responsibility and liability for any improper or unsafe handling or use of the EVM by User or its employees, affiliates, contractors or designees.
 - 4.4 User assumes all responsibility and liability to determine whether the EVM is subject to any applicable international, federal, state, or local laws and regulations related to User's handling and use of the EVM and, if applicable, User assumes all responsibility and liability for compliance in all respects with such laws and regulations. User assumes all responsibility and liability for proper disposal and recycling of the EVM consistent with all applicable international, federal, state, and local requirements.
 5. *Accuracy of Information:* To the extent TI provides information on the availability and function of EVMs, TI attempts to be as accurate as possible. However, TI does not warrant the accuracy of EVM descriptions, EVM availability or other information on its websites as accurate, complete, reliable, current, or error-free.
 6. *Disclaimers:*
 - 6.1 EXCEPT AS SET FORTH ABOVE, EVMS AND ANY MATERIALS PROVIDED WITH THE EVM (INCLUDING, BUT NOT LIMITED TO, REFERENCE DESIGNS AND THE DESIGN OF THE EVM ITSELF) ARE PROVIDED "AS IS" AND "WITH ALL FAULTS." TI DISCLAIMS ALL OTHER WARRANTIES, EXPRESS OR IMPLIED, REGARDING SUCH ITEMS, INCLUDING BUT NOT LIMITED TO ANY EPIDEMIC FAILURE WARRANTY OR IMPLIED WARRANTIES OF MERCHANTABILITY OR FITNESS FOR A PARTICULAR PURPOSE OR NON-INFRINGEMENT OF ANY THIRD PARTY PATENTS, COPYRIGHTS, TRADE SECRETS OR OTHER INTELLECTUAL PROPERTY RIGHTS.
 - 6.2 EXCEPT FOR THE LIMITED RIGHT TO USE THE EVM SET FORTH HEREIN, NOTHING IN THESE TERMS SHALL BE CONSTRUED AS GRANTING OR CONFERRING ANY RIGHTS BY LICENSE, PATENT, OR ANY OTHER INDUSTRIAL OR INTELLECTUAL PROPERTY RIGHT OF TI, ITS SUPPLIERS/LICENSORS OR ANY OTHER THIRD PARTY, TO USE THE EVM IN ANY FINISHED END-USER OR READY-TO-USE FINAL PRODUCT, OR FOR ANY INVENTION, DISCOVERY OR IMPROVEMENT, REGARDLESS OF WHEN MADE, CONCEIVED OR ACQUIRED.
 7. *USER'S INDEMNITY OBLIGATIONS AND REPRESENTATIONS.* USER WILL DEFEND, INDEMNIFY AND HOLD TI, ITS LICENSORS AND THEIR REPRESENTATIVES HARMLESS FROM AND AGAINST ANY AND ALL CLAIMS, DAMAGES, LOSSES, EXPENSES, COSTS AND LIABILITIES (COLLECTIVELY, "CLAIMS") ARISING OUT OF OR IN CONNECTION WITH ANY HANDLING OR USE OF THE EVM THAT IS NOT IN ACCORDANCE WITH THESE TERMS. THIS OBLIGATION SHALL APPLY WHETHER CLAIMS ARISE UNDER STATUTE, REGULATION, OR THE LAW OF TORT, CONTRACT OR ANY OTHER LEGAL THEORY, AND EVEN IF THE EVM FAILS TO PERFORM AS DESCRIBED OR EXPECTED.

8. *Limitations on Damages and Liability:*

8.1 *General Limitations.* IN NO EVENT SHALL TI BE LIABLE FOR ANY SPECIAL, COLLATERAL, INDIRECT, PUNITIVE, INCIDENTAL, CONSEQUENTIAL, OR EXEMPLARY DAMAGES IN CONNECTION WITH OR ARISING OUT OF THESE TERMS OR THE USE OF THE EVMS , REGARDLESS OF WHETHER TI HAS BEEN ADVISED OF THE POSSIBILITY OF SUCH DAMAGES. EXCLUDED DAMAGES INCLUDE, BUT ARE NOT LIMITED TO, COST OF REMOVAL OR REINSTALLATION, ANCILLARY COSTS TO THE PROCUREMENT OF SUBSTITUTE GOODS OR SERVICES, RETESTING, OUTSIDE COMPUTER TIME, LABOR COSTS, LOSS OF GOODWILL, LOSS OF PROFITS, LOSS OF SAVINGS, LOSS OF USE, LOSS OF DATA, OR BUSINESS INTERRUPTION. NO CLAIM, SUIT OR ACTION SHALL BE BROUGHT AGAINST TI MORE THAN TWELVE (12) MONTHS AFTER THE EVENT THAT GAVE RISE TO THE CAUSE OF ACTION HAS OCCURRED.

8.2 *Specific Limitations.* IN NO EVENT SHALL TI'S AGGREGATE LIABILITY FROM ANY USE OF AN EVM PROVIDED HEREUNDER, INCLUDING FROM ANY WARRANTY, INDEMNITY OR OTHER OBLIGATION ARISING OUT OF OR IN CONNECTION WITH THESE TERMS, , EXCEED THE TOTAL AMOUNT PAID TO TI BY USER FOR THE PARTICULAR EVM(S) AT ISSUE DURING THE PRIOR TWELVE (12) MONTHS WITH RESPECT TO WHICH LOSSES OR DAMAGES ARE CLAIMED. THE EXISTENCE OF MORE THAN ONE CLAIM SHALL NOT ENLARGE OR EXTEND THIS LIMIT.

9. *Return Policy.* Except as otherwise provided, TI does not offer any refunds, returns, or exchanges. Furthermore, no return of EVM(s) will be accepted if the package has been opened and no return of the EVM(s) will be accepted if they are damaged or otherwise not in a resalable condition. If User feels it has been incorrectly charged for the EVM(s) it ordered or that delivery violates the applicable order, User should contact TI. All refunds will be made in full within thirty (30) working days from the return of the components(s), excluding any postage or packaging costs.

10. *Governing Law:* These terms and conditions shall be governed by and interpreted in accordance with the laws of the State of Texas, without reference to conflict-of-laws principles. User agrees that non-exclusive jurisdiction for any dispute arising out of or relating to these terms and conditions lies within courts located in the State of Texas and consents to venue in Dallas County, Texas. Notwithstanding the foregoing, any judgment may be enforced in any United States or foreign court, and TI may seek injunctive relief in any United States or foreign court.

Mailing Address: Texas Instruments, Post Office Box 655303, Dallas, Texas 75265
Copyright © 2023, Texas Instruments Incorporated

IMPORTANT NOTICE AND DISCLAIMER

TI PROVIDES TECHNICAL AND RELIABILITY DATA (INCLUDING DATA SHEETS), DESIGN RESOURCES (INCLUDING REFERENCE DESIGNS), APPLICATION OR OTHER DESIGN ADVICE, WEB TOOLS, SAFETY INFORMATION, AND OTHER RESOURCES "AS IS" AND WITH ALL FAULTS, AND DISCLAIMS ALL WARRANTIES, EXPRESS AND IMPLIED, INCLUDING WITHOUT LIMITATION ANY IMPLIED WARRANTIES OF MERCHANTABILITY, FITNESS FOR A PARTICULAR PURPOSE OR NON-INFRINGEMENT OF THIRD PARTY INTELLECTUAL PROPERTY RIGHTS.

These resources are intended for skilled developers designing with TI products. You are solely responsible for (1) selecting the appropriate TI products for your application, (2) designing, validating and testing your application, and (3) ensuring your application meets applicable standards, and any other safety, security, regulatory or other requirements.

These resources are subject to change without notice. TI grants you permission to use these resources only for development of an application that uses the TI products described in the resource. Other reproduction and display of these resources is prohibited. No license is granted to any other TI intellectual property right or to any third party intellectual property right. TI disclaims responsibility for, and you will fully indemnify TI and its representatives against, any claims, damages, costs, losses, and liabilities arising out of your use of these resources.

TI's products are provided subject to [TI's Terms of Sale](#) or other applicable terms available either on [ti.com](https://www.ti.com) or provided in conjunction with such TI products. TI's provision of these resources does not expand or otherwise alter TI's applicable warranties or warranty disclaimers for TI products.

TI objects to and rejects any additional or different terms you may have proposed.

Mailing Address: Texas Instruments, Post Office Box 655303, Dallas, Texas 75265
Copyright © 2024, Texas Instruments Incorporated