

TPS54521 Step-Down Converter Evaluation Module User's Guide



Table of Contents

1 Introduction	3
1.1 Background.....	3
1.2 Performance Specification Summary.....	3
1.3 Modifications.....	4
2 Test Setup and Results	5
2.1 Input / Output Connections.....	5
2.2 Efficiency.....	6
2.3 Output Voltage Load Regulation.....	7
2.4 Output Voltage Line Regulation.....	7
2.5 Load Transients.....	8
2.6 Loop Characteristics.....	8
2.7 Output Voltage Ripple.....	9
2.8 Input Voltage Ripple.....	9
2.9 Powering Up.....	10
2.10 Hiccup Overcurrent Mode Operation.....	11
2.11 Thermal Characteristics.....	11
3 Board Layout	13
3.1 Layout.....	13
3.2 Estimated Circuit Area.....	14
4 Schematic and Bill of Materials	15
4.1 Schematic.....	15
4.2 Bill of Materials.....	17
5 Revision History	17

List of Figures

Figure 2-1. TPS54521EVM-607 Efficiency.....	6
Figure 2-2. TPS54521EVM-607 Low Current Efficiency.....	6
Figure 2-3. TPS54521EVM-607 Load Regulation.....	7
Figure 2-4. TPS54521EVM-607 Line Regulation.....	7
Figure 2-5. TPS54521EVM-607 Transient Response.....	8
Figure 2-6. TPS54521EVM-607 Loop Response.....	8
Figure 2-7. TPS54521EVM-607 Output Ripple.....	9
Figure 2-8. TPS54521EVM-607 Input Ripple.....	9
Figure 2-9. TPS54521EVM-607 Start-Up Relative to V_{IN}	10
Figure 2-10. TPS54521EVM-607 Start-Up Relative to Enable.....	10
Figure 2-11. TPS54521EVM-607 Overcurrent Hiccup Mode.....	11
Figure 2-12. TPS54521EVM-607 Thermal Image.....	11
Figure 2-13. TPS54521EVM-607 Junction Temperature vs Load Current.....	12
Figure 3-1. TPS54521EVM-607 Top-Side Layout (Top View).....	13
Figure 3-2. TPS54521EVM-607 Layer 2 (X-Ray Top View).....	13
Figure 3-3. TPS54521EVM-607 Layer 3 (X-Ray Top View).....	14
Figure 3-4. TPS54521EVM-607 Bottom-Side Layout (Bottom View).....	14
Figure 3-5. TPS54521EVM-607 Top-Side Assembly.....	14
Figure 4-1. TPS54521EVM-607 Schematic.....	16

List of Tables

Table 1-1. Input Voltage and Output Current Summary.....	3
Table 1-2. TPS54521EVM-607 Performance Specification Summary.....	3
Table 1-3. Output Voltages Available.....	4

Table 2-1. EVM Connectors and Test Points.....	5
Table 4-1. TPS54521EVM-607 Bill of Materials.....	17

Trademarks

All trademarks are the property of their respective owners.

1 Introduction

This user's guide contains background information for the TPS54521, as well as support documentation for the TPS54521EVM-607 evaluation module (HPA607). Also included are the performance specifications, the schematic, and the bill of materials for the TPS54521EVM-607.

1.1 Background

The TPS54521 dc/dc converter is designed to provide up to a 5 A output. The TPS54521 implements split input power rails with separate input voltage inputs for the power stage and control circuitry. The power stage input (PVIN) is rated for 1.6 V to 17 V while the control input (VIN) is rated for 4.5 to 17 V. The TPS54521EVM-607 provides both inputs but is designed and tested using the PVIN connected to VIN. Rated input voltage and output current range for the evaluation module are given in [Table 1-1](#). This evaluation module demonstrates a low cost design that may be achieved when designing with the TPS54521 regulator. The switching frequency is externally set at a nominal 480 kHz. The high-side and low-side MOSFETs are incorporated inside the TPS54521 package along with the gate drive circuitry. The compensation components are external to the integrated circuit (IC), and an external divider allows for an adjustable output voltage. Additionally, the TPS54521 provides adjustable slow start, tracking and undervoltage lockout inputs. The absolute maximum input voltage is 20 V for the TPS54521EVM-607.

Table 1-1. Input Voltage and Output Current Summary

EVM	INPUT VOLTAGE RANGE	OUTPUT CURRENT RANGE
TPS54521EVM-607	VIN = 8 V to 17 V (VIN start voltage = 6.806 V)	0 A to 5 A

1.2 Performance Specification Summary

A summary of the TPS54521EVM-607 performance specifications is provided in [Table 1-2](#). Specifications are given for an input voltage of 12 V and an output voltage of 3.3 V, unless otherwise specified. The TPS54521EVM-607 is designed and tested for VIN = 8 V to 17 V with the VIN and PVIN pins connected together with the JP1 jumper. The ambient temperature is 25°C for all measurements, unless otherwise noted.

Table 1-2. TPS54521EVM-607 Performance Specification Summary

SPECIFICATION	TEST CONDITIONS	MIN	TYP	MAX	UNIT
VIN voltage range (PVIN = VIN)		8	12	17	V
VIN start voltage			6.806		V
VIN stop voltage			4.824		V
Output voltage set point			3.3		V
Output current range	VIN = 8 V to 17 V	0		5	A
Line regulation	IO = 5 A, VIN = 8 V to 17 V		±0.04%		
Load regulation	VIN = 12 V, IO = 0 A to 5 A		±0.05%		
Load transient response	IO = 2 A to 4 A	Voltage change	150		mV
		Recovery time	6		µs
	IO = 4 A to 2 A	Voltage change	125		mV
		Recovery time	6		µs
Loop bandwidth	VIN = 12 V, IO = 5 A		42		kHz
Phase margin	VIN = 12 V, IO = 5 A		62		°
Input ripple voltage	VIN = 12 V, IO = 5 A		500		mVPP
Output ripple voltage	VIN = 12 V, IO = 5 A		75		mVPP
Output rise time			3.5		ms
Operating frequency			480		kHz
Maximum efficiency	TPS54521EVM-607, VIN = 8 V, IO = 1.1 A		94.5%		

1.3 Modifications

These evaluation modules are designed to provide access to the features of the TPS54521. Some modifications can be made to this module.

1.3.1 Output Voltage Set Point

The output voltage is set by the resistor divider network of R8 and R9. R9 is fixed at 10 kΩ. To change the output voltage of the EVM, it is necessary to change the value of resistor R8. Changing the value of R8 can change the output voltage above 0.8 V. The value of R8 for a specific output voltage can be calculated using [Equation 1](#).

$$R8 = \frac{10 \text{ k}\Omega (V_{\text{OUT}} - 0.8 \text{ V})}{0.8 \text{ V}} \quad (1)$$

[Table 1-3](#) lists the R8 values for some common output voltages. Note that V_{IN} must be in a range so that the minimum on-time is greater than 135 ns, and the maximum duty cycle is less than 95%. In addition, different output voltages may require different frequency compensation, which will require changes to the values of R4, C4, C6, and C11. The values given in [Table 1-3](#) are standard values, not the exact value calculated using [Equation 1](#).

Table 1-3. Output Voltages Available

OUTPUT VOLTAGE (V)	R ₈ VALUE (kΩ)
1.8	12.4
2.5	21.5
3.3	31.6
5	52.3

1.3.2 Slow-Start Time

The slow-start time can be adjusted by changing the value of C7. Use [Equation 2](#) to calculate the required value of C7 for a desired slow-start time.

$$C7(\text{nF}) = \frac{T_{\text{ss}}(\text{ms}) \times I_{\text{ss}}(\mu\text{A})}{V_{\text{ref}}(\text{V})} \quad (2)$$

The EVM is set for a slow start time of 3.5 msec using C7 = 0.01 μF.

1.3.3 Track In

The TPS54521 can track an external voltage during start up. The J5 connector is provided to allow connection to that external voltage. Ratio-metric or simultaneous tracking can be implemented using resistor divider R5 and R6. See the [TPS54521 4.5-V to 17-V Input, 5-A Synchronous Step-Down Converter Data Sheet](#) for details.

1.3.4 Adjustable UVLO

The under voltage lock out (UVLO) can be adjusted externally using R1 and R2. The EVM is set for a start voltage of 6.806 V and a stop voltage of 4.824 V using R1 = 511 kΩ and R2 = 100 kΩ. Use [Equation 3](#) and [Equation 4](#) to calculate required resistor values for different start and stop voltages.

$$R1 = \frac{V_{\text{START}} \left(\frac{V_{\text{ENFALLING}}}{V_{\text{ENRISING}}} \right) - V_{\text{STOP}}}{I_p \left(1 - \frac{V_{\text{ENFALLING}}}{V_{\text{ENRISING}}} \right) + I_h} \quad (3)$$

$$R2 = \frac{R1 \times V_{\text{ENFALLING}}}{V_{\text{STOP}} - V_{\text{ENFALLING}} + R1(I_p + I_h)} \quad (4)$$

1.3.5 Input Voltage Rails

The EVM is designed to accommodate different input voltage levels for the power stage and control logic. During normal operation, the PVIN and VIN inputs are connected together using a jumper across JP1. The single input voltage is supplied at J1. If desired, these two input voltage rails may be separated by removing the jumper across JP1. Two input voltages must then be provided at both J1 and J2. C1 is provided for adding additional input capacitance for the PVIN input, if desired.

2 Test Setup and Results

This section describes how to properly connect, set up, and use the TPS54521EVM-607 evaluation module. The section also includes test results typical for the evaluation module and covers efficiency, output voltage regulation, load transients, loop response, output ripple, input ripple, and start-up.

2.1 Input / Output Connections

The TPS54521EVM-607 is provided with input/output connectors and test points as shown in [Table 2-1](#). A power supply capable of supplying 3 A must be connected to J1 through a pair of 20 AWG wires. The jumper across JP1 must be in place. See [Section 1.3.5](#) for split input voltage rail operation. The load must be connected to J3 through a pair of 20 AWG wires. The maximum load current capability must be 5 A. Wire lengths must be minimized to reduce losses in the wires. Test-point TP1 provides a place to monitor the V_{IN} input voltages with TP2 providing a convenient ground reference. TP8 is used to monitor the output voltage with TP9 as the ground reference.

Table 2-1. EVM Connectors and Test Points

REFERENCE DESIGNATOR	FUNCTION
J1	PVIN input voltage connector. See Table 1-1 for V_{IN} range.
J2	VIN input voltage connector. Not normally used
J3	V_{OUT} , 3.3 V at 5-A maximum
J4	2-pin header for tracking output and ground
J5	2-pin header for tracking voltage input and ground
JP1	PVIN to VIN jumper. Normally closed to tie VIN to PVIN for common rail voltage operation
JP2	2-pin header for enable. Connect EN to ground to disable, open to enable.
TP1	PVIN test point at PVIN connector
TP2	GND test point at PVIN connector
TP3	VIN test point at VIN connector
TP4	GND test point at VIN connector
TP5	PH test point
TP6	Slow start / track in test point
TP7	Test point between voltage divider network and output. Used for loop response measurements.
TP8	Output voltage test point at V_{OUT} connector
TP9	GND test point at V_{OUT} connector
TP10	PWRGD test point

2.2 Efficiency

The efficiency of this EVM peaks at a load current of about 1.1 A and then decreases as the load current increases towards full load. [Figure 2-1](#) shows the efficiency for the TPS54521EVM-607 at an ambient temperature of 25°C.

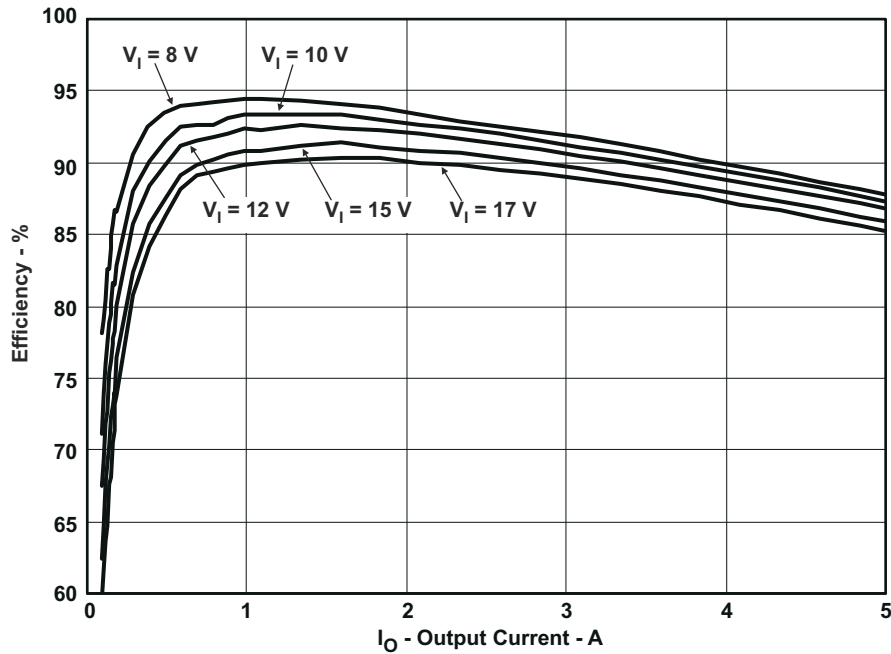

Figure 2-1. TPS54521EVM-607 Efficiency

[Figure 2-2](#) shows the efficiency for the TPS54521EVM-607 at lower output currents below 0.10 A at an ambient temperature of 25°C.

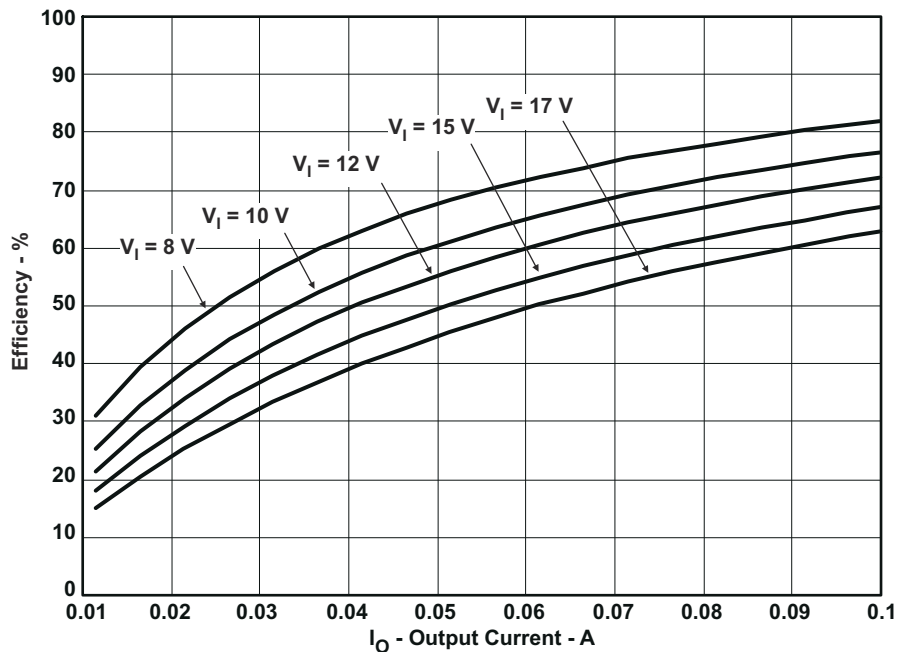

Figure 2-2. TPS54521EVM-607 Low Current Efficiency

The efficiency may be lower at higher ambient temperatures, due to temperature variation in the drain-to-source resistance of the internal MOSFETs.

2.3 Output Voltage Load Regulation

Figure 2-3 shows the load regulation for the TPS54521EVM-607.

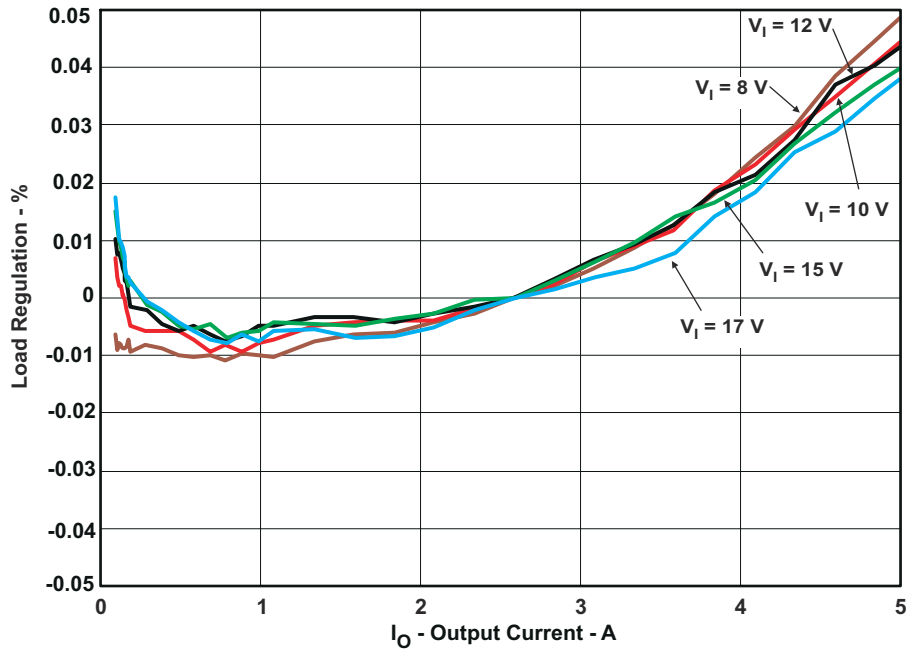

Figure 2-3. TPS54521EVM-607 Load Regulation

Measurements are given for an ambient temperature of 25°C.

2.4 Output Voltage Line Regulation

Figure 2-4 shows the line regulation for the TPS54521EVM-607.

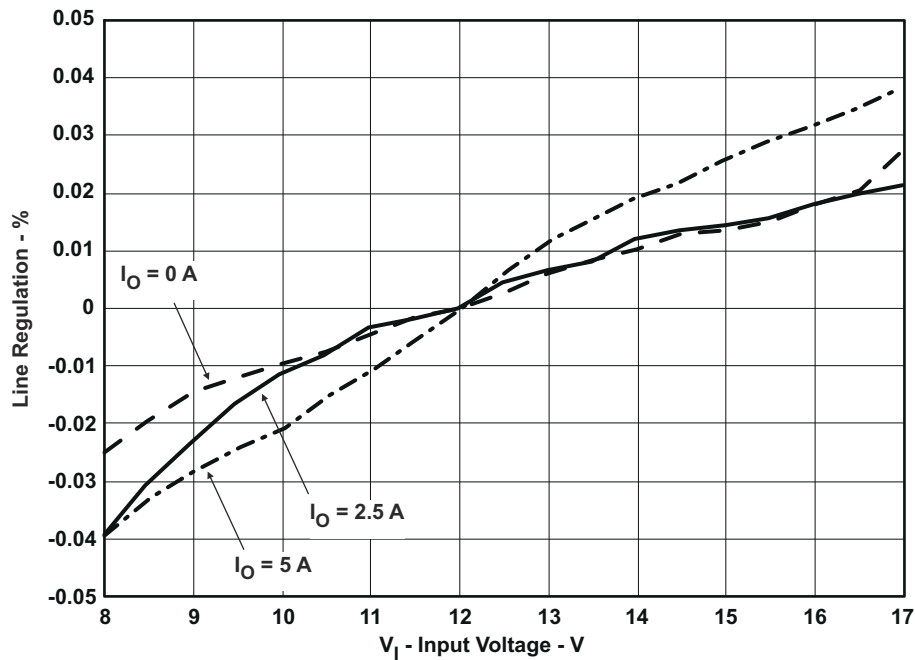

Figure 2-4. TPS54521EVM-607 Line Regulation

2.5 Load Transients

Figure 2-5 shows the TPS54521EVM-607 response to load transients. The current step is from 2 A to 4 A at 12 V input. Total peak-to-peak voltage variation is as shown, including ripple and noise on the output.

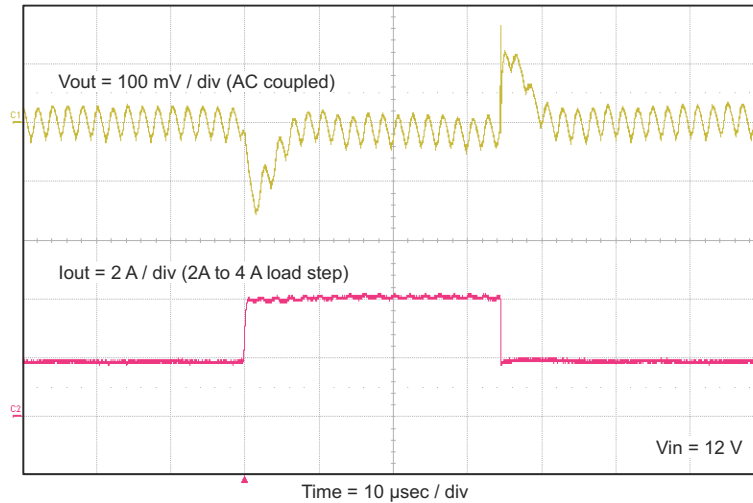

Figure 2-5. TPS54521EVM-607 Transient Response

2.6 Loop Characteristics

Figure 2-6 shows the TPS54521EVM-607 loop-response characteristics. Gain and phase plots are shown for V_{IN} voltage of 12 V. Load current for the measurement is 5 A.

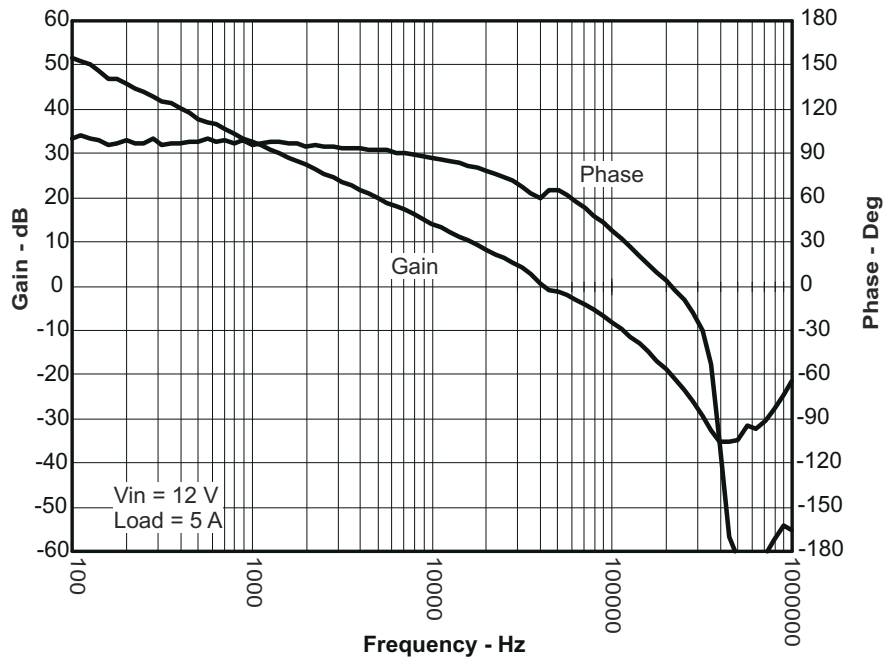

Figure 2-6. TPS54521EVM-607 Loop Response

2.7 Output Voltage Ripple

Figure 2-7 shows the TPS54521EVM-607 output voltage ripple. The output current is the rated full load of 5 A and $V_{IN} = 12$ V. The ripple voltage is measured directly across the output capacitors.

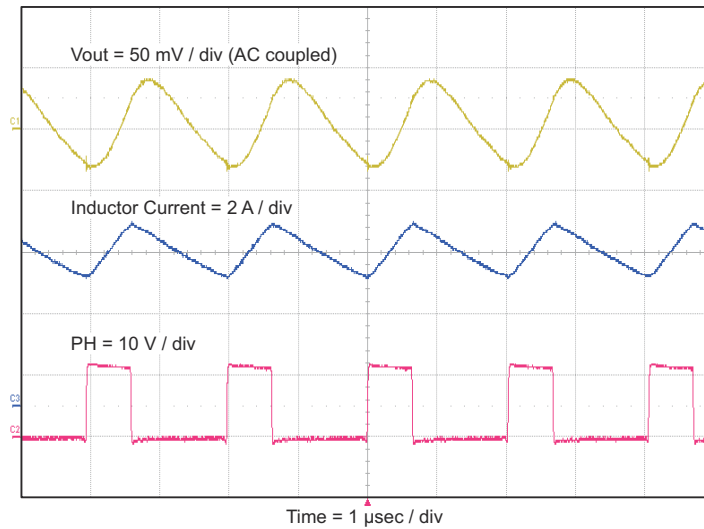

Figure 2-7. TPS54521EVM-607 Output Ripple

2.8 Input Voltage Ripple

Figure 2-8 shows the TPS54521EVM-607 input voltage ripple. The output current is the rated full load of 5 A and $V_{IN} = 12$ V. The ripple voltage is measured directly across the input capacitors.

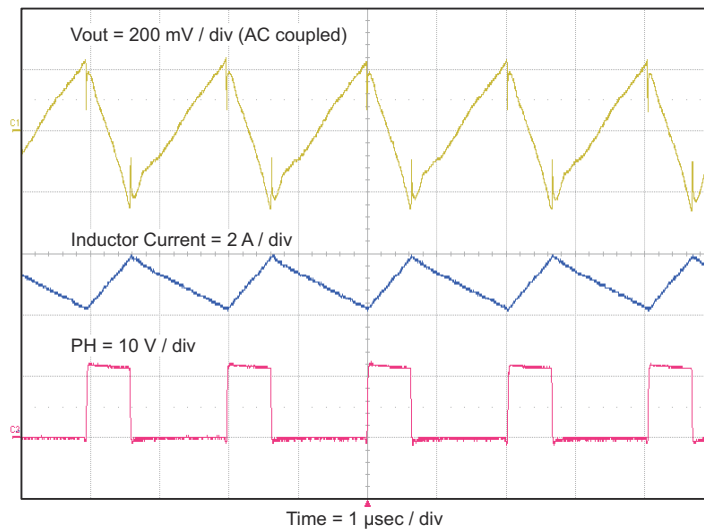

Figure 2-8. TPS54521EVM-607 Input Ripple

2.9 Powering Up

Figure 2-9 and Figure 2-10 show the start-up waveforms for the TPS54521EVM-607. In Figure 2-9, the output voltage ramps up as soon as the input voltage reaches the UVLO threshold as set by the R1 and R2 resistor divider network. In Figure 2-10, the input voltage is initially applied and the output is inhibited by using a jumper at J2 to tie EN to GND. When the jumper is removed, EN is released. When the EN voltage reaches the enable-threshold voltage, the start-up sequence begins and the output voltage ramps up to the externally set value of 3.3 V. The input voltage for these plots is 12 V and the load is 0.66 Ω .

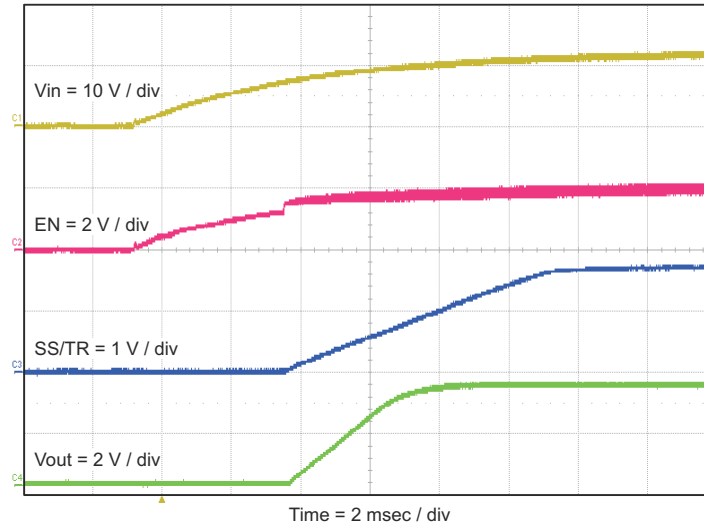

Figure 2-9. TPS54521EVM-607 Start-Up Relative to V_{IN}

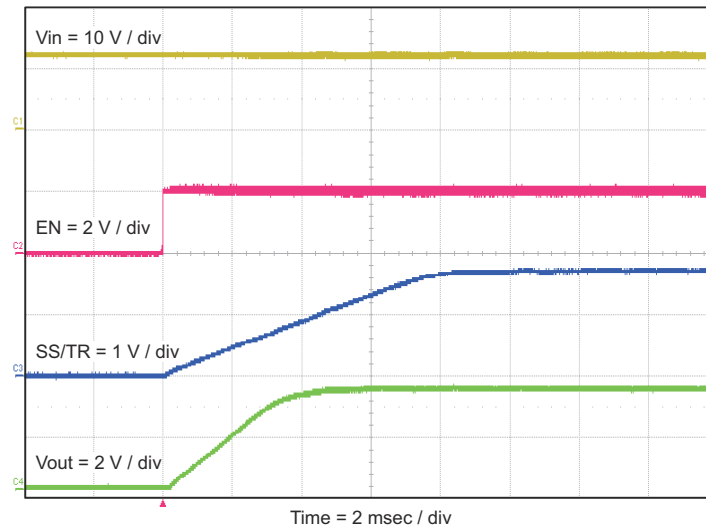

Figure 2-10. TPS54521EVM-607 Start-Up Relative to Enable

2.10 Hiccup Overcurrent Mode Operation

Figure 2-11 shows the TPS54521EVM-607 operating in a near shorted output ($0.1\ \Omega$ load) condition. If the current in the high-side MOSFET reaches the current limit for 512 switching cycles in a row, the TPS54521 enters hiccup overcurrent protection and stops switching (hiccup) for the next 16384 cycles.

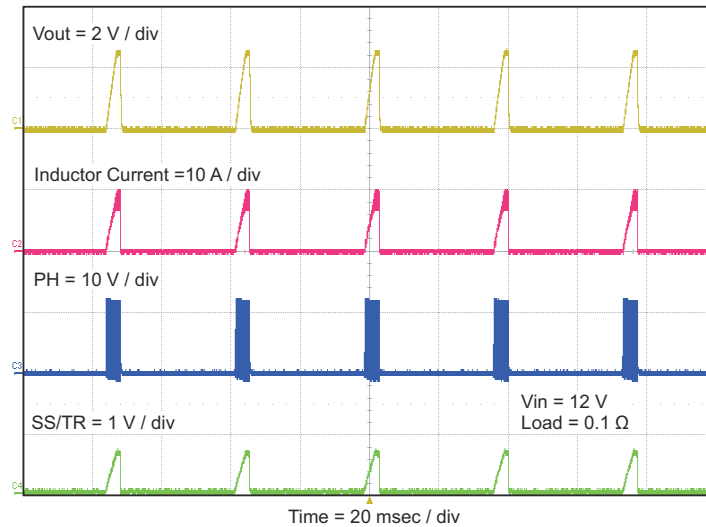

Figure 2-11. TPS54521EVM-607 Overcurrent Hiccup Mode

2.11 Thermal Characteristics

This section shows a thermal image of the TPS54521EVM-607 running at 12 V input and 5 A load and a graph showing the junction temperature vs. output current of the EVM circuit. There is no air flow and the ambient temperature is 25°C . The peak temperature of the IC (91.9°C) is below the maximum recommended operating condition listed in the data sheet of 125°C .

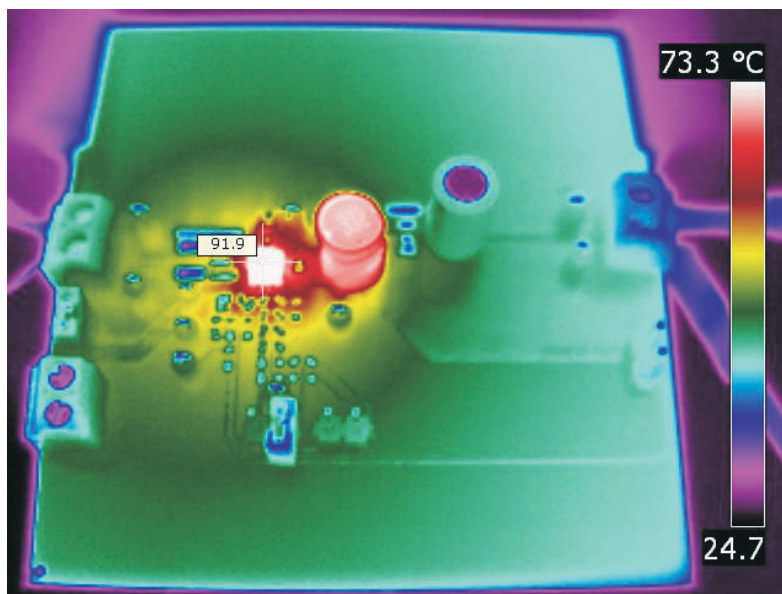

Figure 2-12. TPS54521EVM-607 Thermal Image

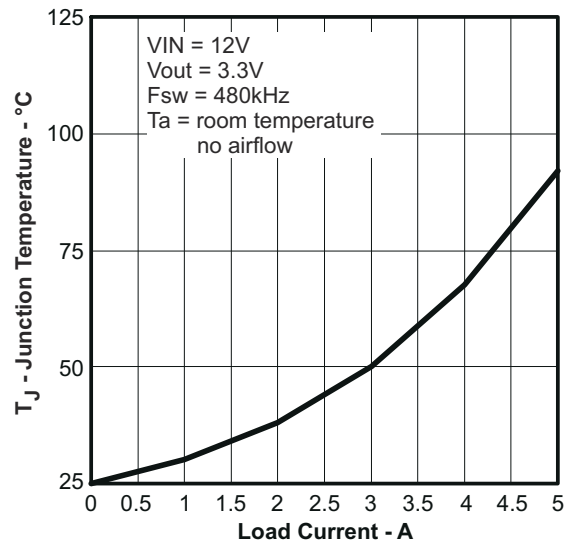

Figure 2-13. TPS54521EVM-607 Junction Temperature vs Load Current

3 Board Layout

This section provides a description of the TPS54521EVM-607, board layout, and layer illustrations.

3.1 Layout

The board layout for the TPS54521EVM-607 is shown in [Figure 3-1](#) through [Figure 3-5](#). The topside layer of the EVM is laid out in a manner typical of a user application. The top, bottom and internal layers are 2-oz. copper.

The top layer contains the main power traces for PVIN, VIN, V_{OUT}, and VPHASE. Also on the top layer are connections for the remaining pins of the TPS54521 and a large area filled with ground. The bottom and internal ground layers contain ground planes only. The top side ground traces are connected to the bottom and internal ground planes with multiple vias placed around the board including two vias directly under the TPS54521 device to provide a thermal path from the top-side ground plane to the bottom-side ground plane.

The input decoupling capacitors (C2, and C3) and bootstrap capacitor (C5) are all located as close to the IC as possible. In addition, the voltage set-point resistor divider components are also kept close to the IC. The voltage divider network ties to the output voltage at the point of regulation, the copper V_{OUT} trace at the J3 output connector. For the TPS54521, an additional input bulk capacitor may be required, depending on the EVM connection to the input supply. Critical analog circuits such as the voltage setpoint divider, frequency set resistor, slow start capacitor and compensation components are terminated to ground using a wide ground trace separate from the power ground pour.

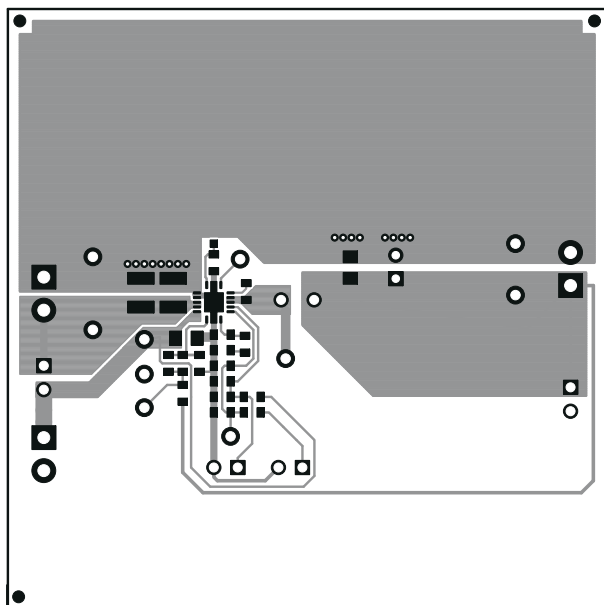

Figure 3-1. TPS54521EVM-607 Top-Side Layout (Top View)

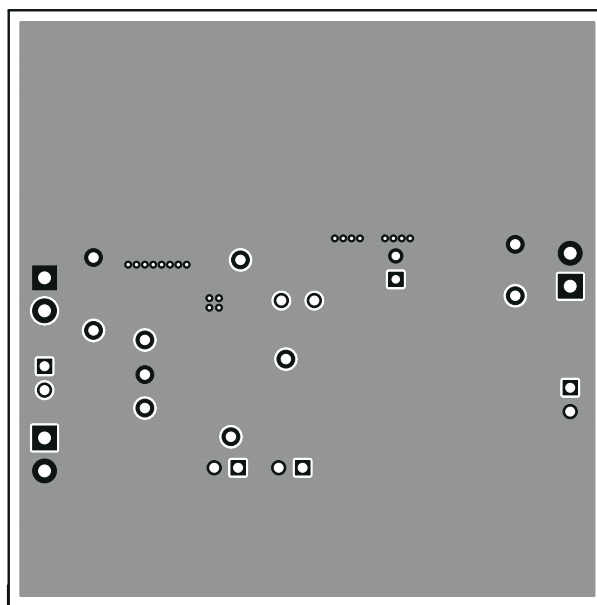

Figure 3-2. TPS54521EVM-607 Layer 2 (X-Ray Top View)

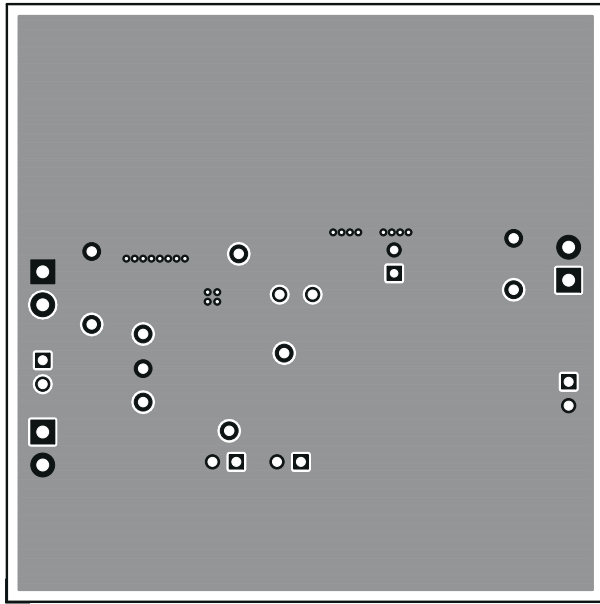

Figure 3-3. TPS54521EVM-607 Layer 3 (X-Ray Top View)

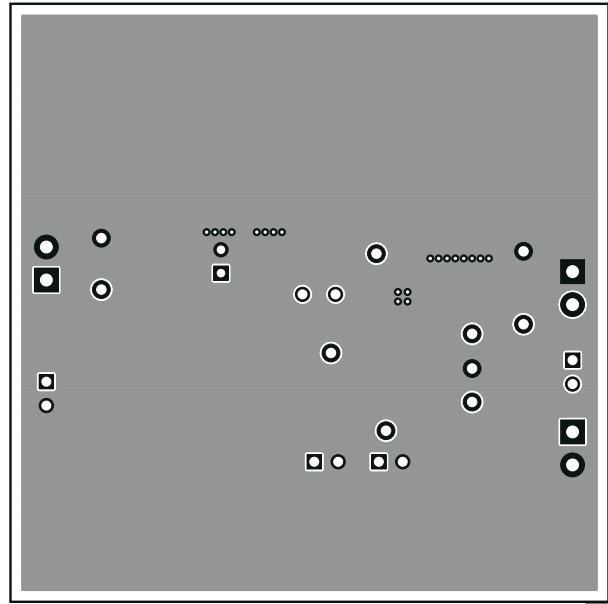

Figure 3-4. TPS54521EVM-607 Bottom-Side Layout (Bottom View)

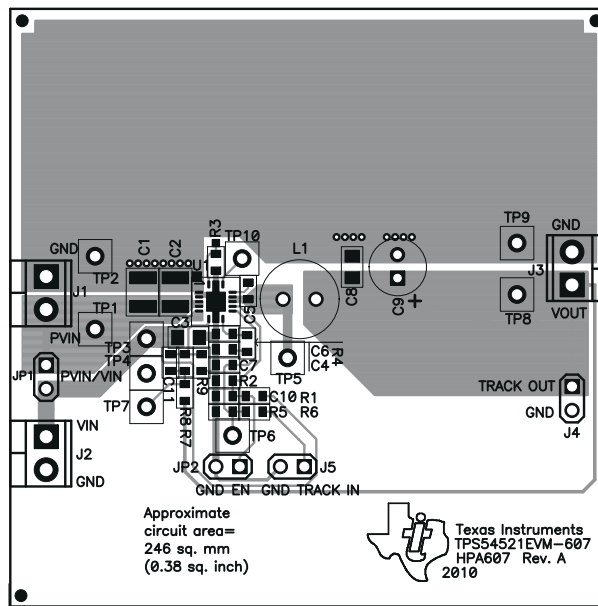

Figure 3-5. TPS54521EVM-607 Top-Side Assembly

3.2 Estimated Circuit Area

The estimated printed circuit board area for the components used in this design is 246 in² (0.38 mm²). This area does not include test point or connectors.

4 Schematic and Bill of Materials

This section presents the TPS54521EVM-607 schematic and bill of materials.

4.1 Schematic

[Figure 4-1](#) is the schematic for the TPS54521EVM-607.

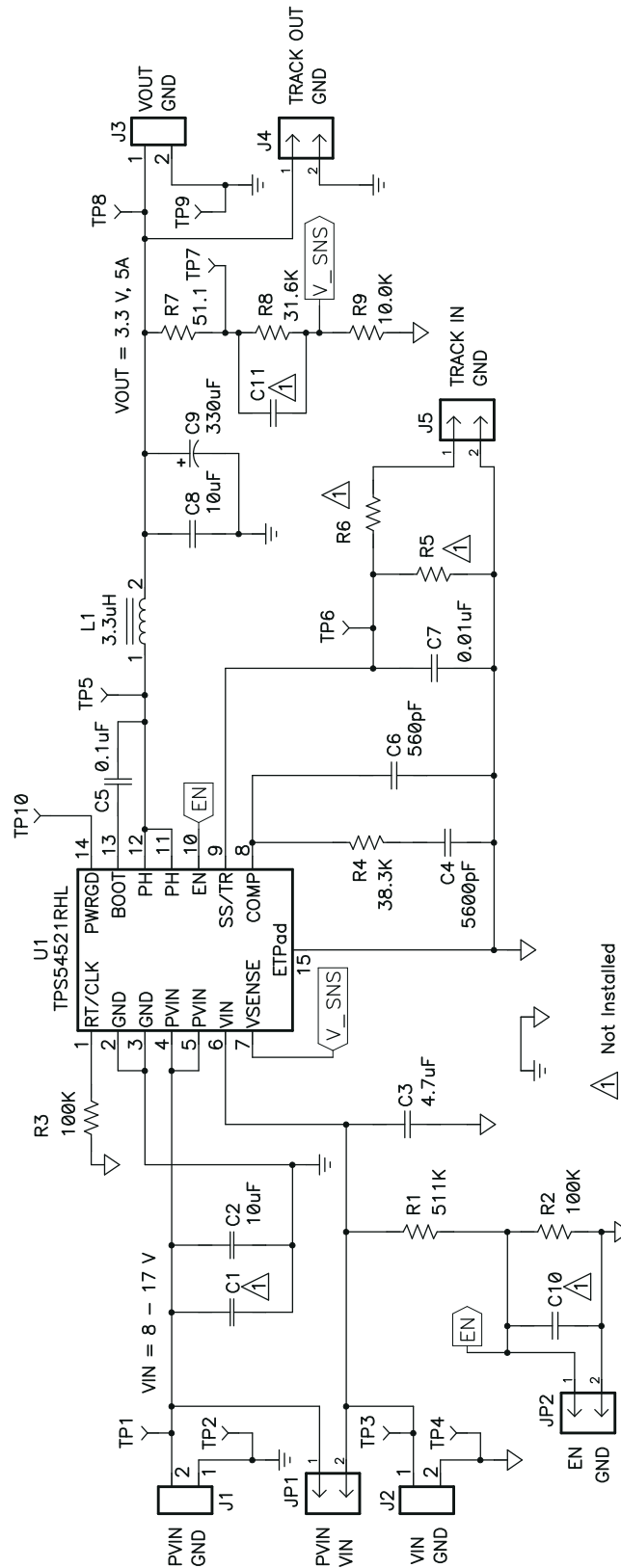

Figure 4-1. TPS54521EVM-607 Schematic

4.2 Bill of Materials

Table 4-1 presents the bill of materials for the TPS54521EVM-607.

Table 4-1. TPS54521EVM-607 Bill of Materials

COUNT	REFDES	VALUE	DESCRIPTION	SIZE	PART NUMBER	MFR
1	C2	10 μ F	Capacitor, Ceramic, 25 V, X5R, 20%	1210	Std	Std
1	C3	4.7 μ F	Capacitor, Ceramic, 25 V, X5R, 10%	0805	Std	Std
1	C4	5600 pF	Capacitor, Ceramic, 50 V, X7R, 10%	0603	Std	Std
1	C5	0.1 μ F	Capacitor, Ceramic, 16 V, X7R, 10%	0603	Std	Std
1	C6	560 pF	Capacitor, Ceramic, 50 V, C0G, 5%	0603	Std	Std
1	C7	0.01 μ F	Capacitor, Ceramic, 10 V, X7R, 10%	0603	Std	Std
1	C8	10 μ F	Capacitor, Ceramic, 10 V, X5R, 10%	0805	Std	Std
1	C9	330 μ F	Capacitor, Alum Electrolytic 6.3 V, 125 m Ω ESR, \pm 20%	6.30 mm Dia	EKZE6R3ELL331 MF11D	Chemi-con
1	L1	3.3 μ H	Inductor, 12m Ω DCR, 7.5 A, \pm 20%	0.300 Dia. inch	DR0608-332L	Coilcraft
1	R1	511 K	Resistor, Chip, 1/16W, 1%	0603	Std	Std
2	R2, R3	100 K	Resistor, Chip, 1/16W, 1%	0603	Std	Std
1	R4	38.3 K	Resistor, Chip, 1/16W, 1%	0603	Std	Std
1	R7	51.1	Resistor, Chip, 1/16W, 1%	0603	Std	Std
1	R8	31.6 K	Resistor, Chip, 1/16W, 1%	0603	Std	Std
1	R9	10.0 K	Resistor, Chip, 1/16W, 1%	0603	Std	Std
1	U1	TPS54521RHL	IC, 17V Input, 5-A Output, Sync. Step-Down Switcher With Integrated FET	QFN14	TPS54521RHL	TI

5 Revision History

NOTE: Page numbers for previous revisions may differ from page numbers in the current version.

Changes from Revision * (August 2010) to Revision A (August 2021)

Page

- Updated the numbering format for tables, figures, and cross-references throughout the document.3
- Updated the user's guide title..... 3

IMPORTANT NOTICE AND DISCLAIMER

TI PROVIDES TECHNICAL AND RELIABILITY DATA (INCLUDING DATA SHEETS), DESIGN RESOURCES (INCLUDING REFERENCE DESIGNS), APPLICATION OR OTHER DESIGN ADVICE, WEB TOOLS, SAFETY INFORMATION, AND OTHER RESOURCES "AS IS" AND WITH ALL FAULTS, AND DISCLAIMS ALL WARRANTIES, EXPRESS AND IMPLIED, INCLUDING WITHOUT LIMITATION ANY IMPLIED WARRANTIES OF MERCHANTABILITY, FITNESS FOR A PARTICULAR PURPOSE OR NON-INFRINGEMENT OF THIRD PARTY INTELLECTUAL PROPERTY RIGHTS.

These resources are intended for skilled developers designing with TI products. You are solely responsible for (1) selecting the appropriate TI products for your application, (2) designing, validating and testing your application, and (3) ensuring your application meets applicable standards, and any other safety, security, regulatory or other requirements.

These resources are subject to change without notice. TI grants you permission to use these resources only for development of an application that uses the TI products described in the resource. Other reproduction and display of these resources is prohibited. No license is granted to any other TI intellectual property right or to any third party intellectual property right. TI disclaims responsibility for, and you will fully indemnify TI and its representatives against, any claims, damages, costs, losses, and liabilities arising out of your use of these resources.

TI's products are provided subject to [TI's Terms of Sale](#) or other applicable terms available either on ti.com or provided in conjunction with such TI products. TI's provision of these resources does not expand or otherwise alter TI's applicable warranties or warranty disclaimers for TI products.

TI objects to and rejects any additional or different terms you may have proposed.

Mailing Address: Texas Instruments, Post Office Box 655303, Dallas, Texas 75265
Copyright © 2022, Texas Instruments Incorporated