

Using the TPS54335A to Create an Inverting Power Supply

MiloZhu

ABSTRACT

Some applications, like audio amplifiers, line drivers, and receivers, require a positive input voltage to generate a negative output voltage. This application report presents a solution for creating an inverting power supply using a synchronous buck converter, TPS54335A. The purpose of this application report is to discuss the steps to create a negative power supply using the TPS54335A.

Contents

1	Application Description	2
2	Design Consideration and Procedures.....	2
3	Circuit Typical Performance	7
4	Conclusion	11
5	References	11

List of Figures

1	12 V to –5 V Reference Design.....	3
2	Efficiency Figure	7
3	Load Regulation	7
4	Line Regulation	8
5	Start-Up Without Load	8
6	Shutdown Without Load	8
7	Start-Up With $I_{OUT} = 2\text{ A}$	9
8	Shutdown With $I_{OUT} = 2\text{ A}$	9
9	V_{OUT} Ripple With $I_{OUT} = 0.1\text{ A}$	9
10	V_{OUT} Ripple With $I_{OUT} = 2\text{ A}$	10
11	V_{IN} Ripple With $I_{OUT} = 2\text{ A}$	10
12	Load Transient.....	10
13	Bode Plot	11

List of Tables

1	Design Parameters	3
---	-------------------------	---

Trademarks

All trademarks are the property of their respective owners.

1 Application Description

For a 28-V, 2-A or 3-A solution that covers 12-V, 19-V, and 24 -V power rail applications, TI has a miser family that includes the TPS54231, TPS54331, and TPS54232 devices, but these parts are nonsynchronous. A reference design is available online for inverting power supply applications (see [PMP4748](#), [TPS54232](#)).

Using these nonsynchronous converters for inverting power supply has certain disadvantages, like lower efficiency because of the rectifier diode, and a slight voltage *bump* during soft-start because of the switching frequency fold-back.

Integrating a tight BOM size is becoming more popular. For a 28-V, 3-A solution, the synchronous part TPS54335A supports 4.5-V to 28-V input and output up to 3 A with adjustable switching frequency. An increasing number of customers prefer to choose synchronous solution for their inverting supply application.

This application report discusses how to design an inverting regulator step-by-step using the TPS54335A, as well as component selection criteria and equations, and some captured waveforms.

2 Design Consideration and Procedures

2.1 Choosing the Correct Buck Converter for Inverting Power Applications

When choosing a buck converter for inverting power applications, users must consider certain specifications to determine whether the converter meets the application requirement or not. These specifications include:

- Output voltage range
- Input voltage range
- Allowable duty cycle
- Maximum output current

2.1.1 Output Voltage Range

The difference between the maximum input voltage and output voltage must not exceed the maximum operating voltage of the device. For the TPS54335A, the maximum operating voltage is 28 V. For example, if the output is –5 V, then the maximum input voltage, $V_{IN(max)}$, could be as high as 23 V, which can support a 19-V power rail application.

2.1.2 Input Voltage Range

The minimum operating input voltage of the inverting power supply, $V_{IN(min)}$, must be greater than the minimum device operating voltage. For the TPS54335A, the minimum input voltage is 4.5 V, so the inverting power supply input voltage must be higher than 4.5 V.

2.1.3 Duty Cycle

[Equation 1](#) shows the ideal duty cycle for the inverting power supply, neglecting the losses of the power-switching inductor. The output voltage, V_{OUT} , is negative and the input voltage, V_{IN} , is positive.

$$D = \frac{-V_{OUT}}{V_{IN} - V_{OUT}} \quad (1)$$

The maximum duty cycle, D_{max} , is calculated using the minimum input voltage as a substitution for the input voltage. Similarly, D_{min} is evaluated using the maximum input voltage, $V_{IN(max)}$.

2.1.4 Output Current

Use Equation 2 to estimate whether the selected switching regulator can deliver the output current. The user must know the minimum current limit of the device, $I_{CL(min)}$, maximum duty cycle, D_{max} , and the inductor ripple current value, $I_{L(ripple)}$.

$$I_{O(max)} \leq \left(I_{CL(min)} - \frac{I_{L(ripple)}}{2} \right) \times (1 - D_{max}) \tag{2}$$

For the TPS54335A, the minimum high-side current is 4 A, assume the $I_{L(ripple)}$ is 25% of the minimum current limit, and D_{max} is 0.294 ($-5\text{ V} / (12\text{ V} - (-5\text{ V}))$), then get the max capable of delivering output current is 2.8 A.

2.1.5 Operating Frequency

Selecting an operating frequency is a trade-off between size and thermal performance. Higher frequencies require lower-valued inductors with smaller sizes, which introduces higher switching loss with lower efficiency and higher temperature.

For the TPS54335A, switching frequency is adjustable from 50 kHz to 1.5 MHz using one external resistor. Use Equation 3 to calculate the resistor.

$$R_{RT} (k\Omega) = 55300 \times f_{sw}^{-1.025} (\text{kHz}) \tag{3}$$

2.2 External Component Selection

After the appropriate buck converter is chosen, users must choose the correct external components, like the resistor divider, inductor, input capacitor, output capacitor, bypass capacitor, and loop-compensation resistor and capacitor (see Figure 1).

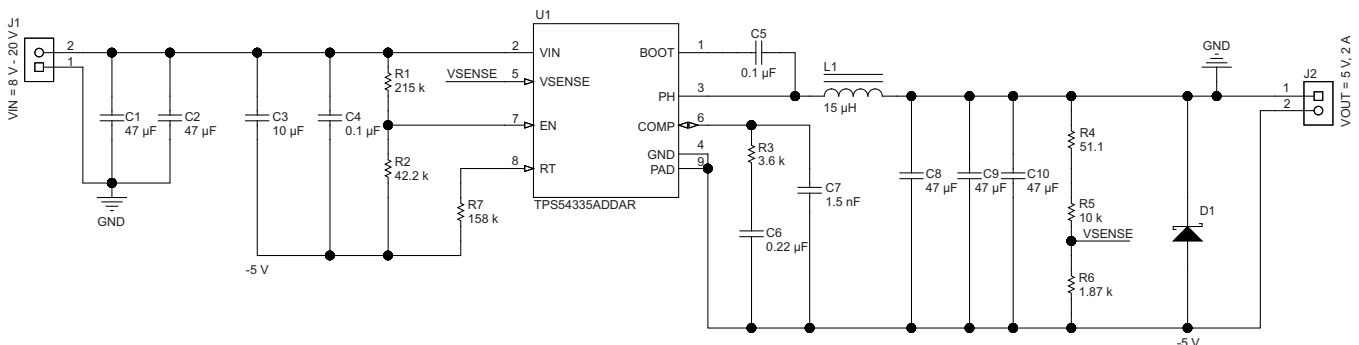

Copyright © 2017, Texas Instruments Incorporated

Figure 1. 12 V to -5 V Reference Design

Table 1 lists the input parameters to use for this design example.

Table 1. Design Parameters

Design Parameter	Example Value
Input voltage range	12 V nominal 8 V to 20 V
Output voltage	-5 V
Transient response, 1-A load step	$\Delta VO = \pm 5\%$
Output ripple voltage	30 mV
Output current rating	2 A
Operating frequency	300 kHz

2.2.1 Frequency Set Resistor

The switching frequency of the TPS54335A is set at 300 kHz. Use [Equation 3](#) to calculate the required value for R_{RT} . The calculated value is 159.8 k Ω . Use the next smaller, standard value of 158 k Ω for R_{RT} .

2.2.2 Resistor Divider

The output voltage of the TPS54335A device is externally adjustable using a resistor divider network. In this example, this divider network is comprised of R5 and R6. Use [Equation 4](#) and [Equation 5](#) to calculate the relationship of the output voltage to the resistor divider.

$$R6 = \frac{R5 \times V_{ref}}{V_{OUT} - V_{ref}} \quad (4)$$

$$V_{OUT} = V_{ref} \times \left(\frac{R5}{R6} + 1 \right) \quad (5)$$

For this design:

- $V_{ref} = 0.8$ V
- Set $R5 = 10$ k Ω and $R6 = 1.87$ k Ω
- The 51.1- Ω resistor R4 is provided as a convenient location to break the control loop for stability testing.

2.2.3 Inductor

To determine the inductor value, use [Equation 6](#) to calculate the average inductor current, IL_{avg} , at the maximum output current and maximum duty. Assuming that the maximum output current, I_{OUT} , is 2 A and using the maximum duty cycle, D_{max} is 0.385 (5 V / (8 V - (-5 V)) = 0.385), here IL_{avg} is 3.25 A.

$$IL_{avg} = \frac{I_{OUT}}{1 - D_{max}} \quad (6)$$

Assuming $V_{IN(max)}$ of 20 V, IL_{avg} of 3.25 A, and f_{sw} of 300 kHz, use [Equation 7](#) to calculate L_O , which is 16.5 μ H. The nearest standard inductor of 15 μ H is used.

$$L_O = \frac{V_{IN(max)} \times D_{min}}{f_{sw} \times IL_{avg} \times 0.25} \quad (7)$$

The inductor saturation current must be greater than the 3.59 A of peak current calculated in [Equation 8](#).

$$IL_{peak} = \frac{I_{OUT}}{1 - D_{max}} + \frac{V_{IN(min)} \times D_{max}}{2 \times f_{sw} \times L_O} \quad (8)$$

The inductor rms current must be greater than the 2.84 A of peak current calculated in [Equation 9](#).

$$IL_{rms} = \sqrt{\left(\frac{I_{OUT}}{1 - D} \right)^2 + \frac{1}{12} \times \left(\frac{V_{IN} \times D}{f_{sw} \times L_O} \right)^2} \quad (9)$$

2.2.4 Output Capacitor

The output capacitor must supply the current when the high-side switch is off. Use the minimum input voltage to calculate the output capacitance needed. This need occurs when the duty cycle and the peak-to-peak current in the output capacitor are the maximum. Using the 0.5% voltage ripple specification, V_{OUT} , and [Equation 10](#), $C_{O(min)}$ is calculated to be 103 μ F.

$$C_{O(min)} \geq \frac{I_{OUT(max)} \times D_{max}}{f_{sw} \times \Delta V_{OUT}} \quad (10)$$

Assuming the 0.5% voltage ripple and maximum duty cycle, the R_C equivalent series resistance must be less than 69.6 m Ω (see Equation 11).

$$R_C \leq \frac{\Delta V_{OUT}}{\frac{I_{OUT}}{1-D_{max}} + \frac{V_{IN(min)} \times D_{max}}{2 \times f_{sw} \times L_O}} \quad (11)$$

Use Equation 12 to calculate the rms current for the output capacitor, which is 1.58 A . Three 47- μ F, 10-V X7R in parallel are used for the output capacitor because of the low ESR and size.

$$I_{corms} = I_{OUT(max)} \times \sqrt{\frac{D_{max}}{1-D_{max}}} \quad (12)$$

2.2.5 Input Capacitors

The input capacitors between V_{IN} and ground are used to limit the voltage ripple of the input supply.

Equation 13, Equation 14, Equation 15, and Equation 16 are used to estimate the capacitance, maximum ESR, and current rating for the input capacitor, C_i .

$$I_{IN(avg)} = \frac{I_{OUT} \times D_{max}}{1-D_{max}} \quad (13)$$

Equation 14 is used to estimate the average input current, which is 1.25 A.

$$C_i = \frac{I_{IN(avg)}}{f_{sw} \times 0.01 \times V_{IN(min)}} \quad (14)$$

Equation 14 and Equation 15 are used to calculate the minimum required input capacitance, which is 52 μ F and the maximum ESR, which is 64 m Ω .

$$ESR_{C_i} \leq \frac{0.01 \times V_{IN(min)}}{I_{IN(avg)}} \quad (15)$$

Using Equation 16, the input capacitor needs a current rating of at least 1.78 A . Two 47- μ F, 35-V X7R in parallel are used for the input capacitor because of the low ESR and size.

$$I_{cirms} = \sqrt{\left((I_{L_{peak}} - I_{IN(avg)})^2 + \frac{\left(\frac{V_{IN(max)} \times D_{max}}{L_O \times f_{sw}} \right)^2}{12} \right) \times D_{max} + I_{IN(avg)}^2 \times (1-D_{max})} \quad (16)$$

2.2.6 Bypass Capacitor

The TPS54335A device needs a tightly coupled, ceramic bypass capacitor, connected to the V_{IN} and GND pin of the device. Because the device GND is the power supply output voltage, the voltage rating of the capacitor must be greater than the differences in the maximum input and output voltage of the power supply.

A minimum of 10 μ F from the V_{IN} pin to GND is recommended for the TPS54335A device. Another 0.1- μ F capacitor has been added as a bypass capacitor to clear high-frequency noise.

2.2.7 Frequency Response of the Inverting Regulator

Using a buck boost regulator to generate a negative output voltage does not close the feedback loop like using a buck power supply, so a different design method is needed. The inverting power supply transfer function has two zeroes and a pole.

Equation 17 is a simplified transfer function of an inverting power supply.

$$T(s) = K_{bb} \times \frac{\left(1 + \frac{s}{2\pi \times fz1}\right) \times \left(1 + \frac{s}{2\pi \times fz2}\right)}{\left(1 + \frac{s}{2\pi \times fp1}\right)} \quad (17)$$

In Equation 18, the ESR zero, $fz1$, is the same as in a buck regulator, and is a function of the output capacitor and its ESR.

$$fz1 = \frac{1}{2\pi \times R_c \times C_o} \quad (18)$$

The other zero is a right half plane zero, $fz2$. The frequency response of $fz2$ results in an increasing gain and a decreasing phase. The $fz2$ frequency is a function of the duty cycle, output current, and the inductor. Equation 19 shows the calculated minimum frequency of $fz2$, which is used to determine the crossover frequency.

$$fz2 = \frac{(1 - D_{max})^2 \times \left(\frac{-V_{OUT}}{I_{OUT}}\right) + R_{dc} \times (1 - D_{max} - D_{max})}{D_{max} \times L_o \times 2\pi} \quad (19)$$

The dominant pole, $fp1$, is a function of the load current, output capacitor, and duty cycle (see Equation 20).

$$fp1 = \frac{1 + D}{\left(\left(\frac{-V_{OUT}}{I_{OUT}}\right) \times C_o \times 2\pi\right)} \quad (20)$$

In Equation 21, K_{bb} is the DC gain and is used to calculate the frequency compensation components. The g_{mps} variable is the transconductance of the power stage, which is 8 A / V for the TPS54335A device.

$$K_{bb} = \frac{V_{IN} \times \left(\frac{-V_{OUT}}{I_{OUT}}\right)}{(V_{IN} + 2 \times (-V_{OUT}))} \times g_{mps} \quad (21)$$

Here, $fz1$ is estimated to be 225.9 kHz. The output capacitor ESR is assumed to be 5 m. Here, $fz2$ is estimated to be 26.3 kHz. Assuming resistance of the inductor, R_{dc} is 20 m. Here, $fp1$ is estimated to be 425 Hz assuming a nominal duty cycle. K_{bb} is calculated as 10.9 V/V using Equation 21, assuming nominal input voltage and g_{mps} as 8 A/V.

The crossover of the power supply should be set between the $fp1$ frequency and 1/3 of the $fz2$ frequency. TI recommends starting with the crossover frequency, f_{co} , given by Equation 22. Here, f_{co} is estimated to be 3.34 kHz.

$$f_{co} = (fp1 \times fz2)^{0.5} \quad (22)$$

Use Equation 23 to calculate the compensation resistor, R_{comp} , needed to set the compensation gain at the f_{co} frequency. For the TPS54335A device, V_{ref} is 0.8 V and g_{mea} is 1300 μ A/V. In Equation 23 R_{comp} is equal to 3.46 k Ω . Use the nearest standard value of 3.5 k Ω .

$$R_{comp} = \left(\frac{f_{co}}{K_{bb} \times fp1}\right) \times \left(\frac{-V_{OUT}}{V_{ref} \times g_{mea}}\right) \quad (23)$$

The compensation zero, C_{zero} , is set to 1/2 of the dominant pole, $fp1$. To calculate the C_{zero} , use Equation 24, which results in 0.22 μ F. Use the next larger standard value of 0.22 μ F.

$$C_{zero} = \frac{1}{2\pi \times \left(\frac{fp1}{2}\right) \times R_{comp}} \quad (24)$$

The compensation pole, C_{pole} , is set to equal the RHP zero, $fz2$. Use Equation 25 to calculate C_{pole} , which results in 1.75 nF. Use the next standard value of 1.5 nF.

$$C_{pole} = \frac{1}{2\pi \times fz2 \times R_{comp}} \tag{25}$$

3 Circuit Typical Performance

The design shown in Figure 1 was used to generate -5-V output from 12-V input. Figure 2 to Figure 13 show some typical measured waveforms of this design.

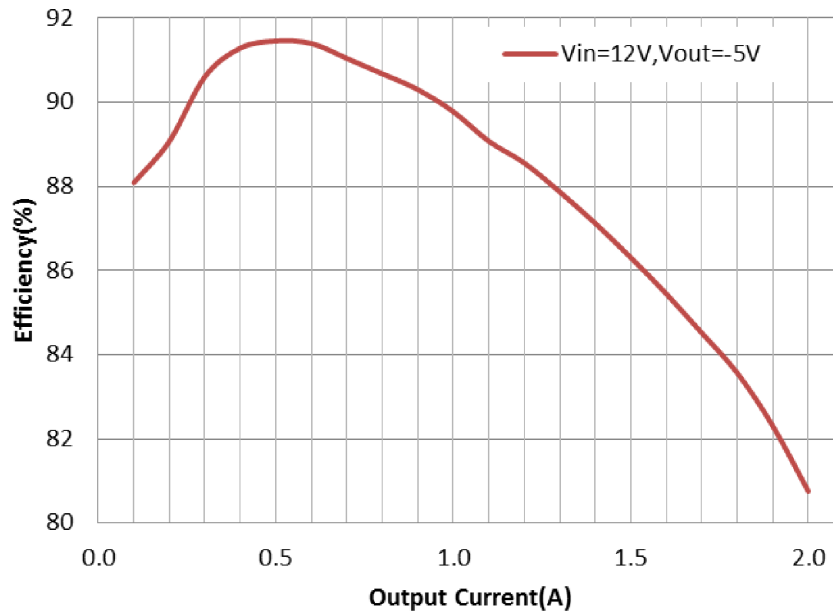

Figure 2. Efficiency Figure

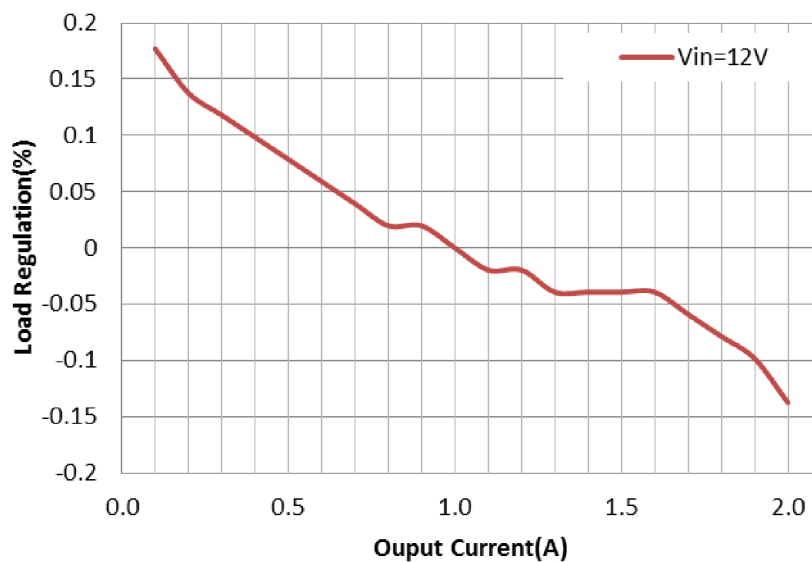

Figure 3. Load Regulation

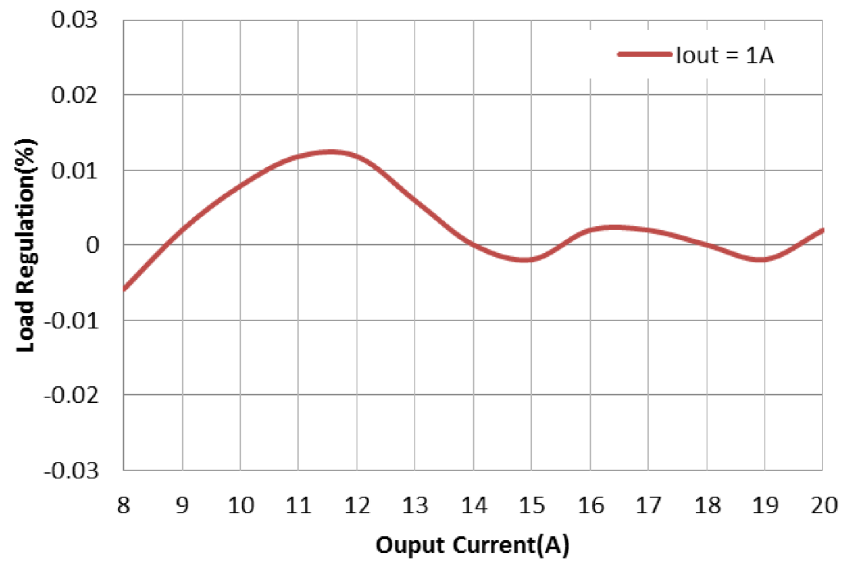

Figure 4. Line Regulation

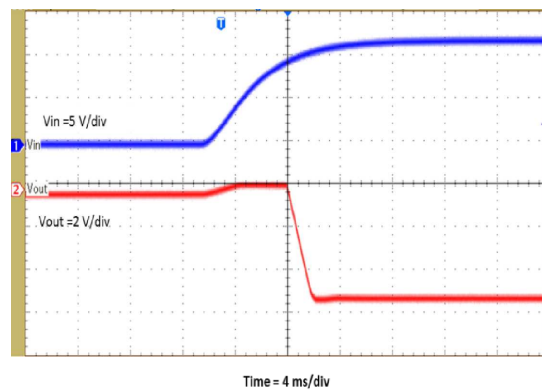

Figure 5. Start-Up Without Load

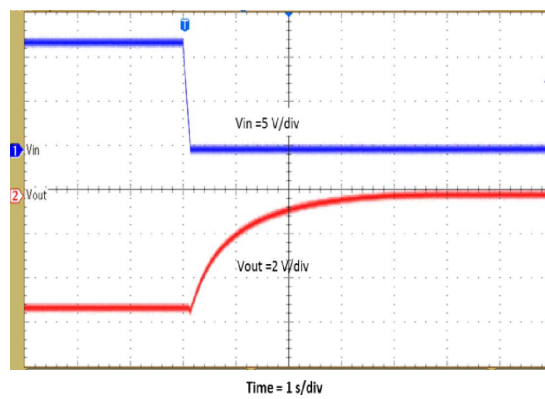

Figure 6. Shutdown Without Load

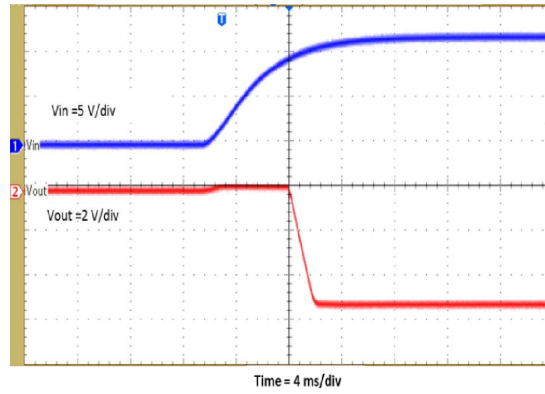

Figure 7. Start-Up With $I_{OUT} = 2\text{ A}$

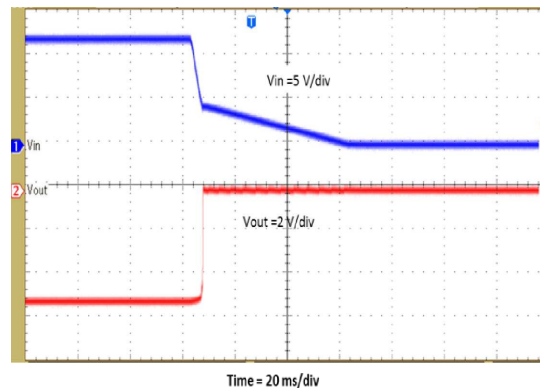

Figure 8. Shutdown With $I_{OUT} = 2\text{ A}$

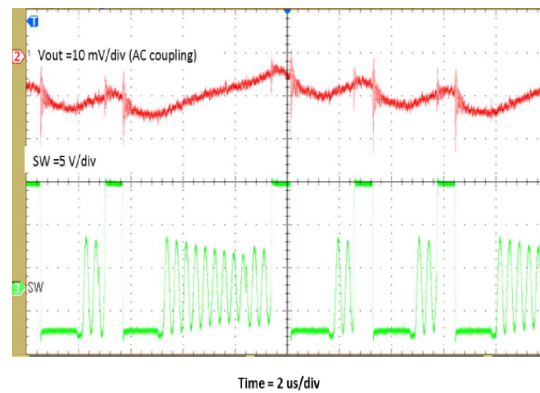

Figure 9. V_{OUT} Ripple With $I_{OUT} = 0.1\text{ A}$

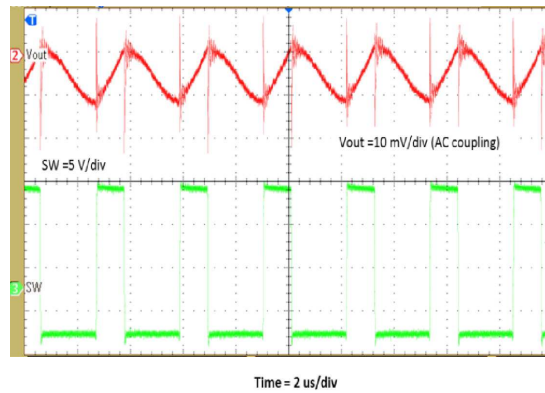

Figure 10. V_{OUT} Ripple With $I_{OUT} = 2\text{ A}$

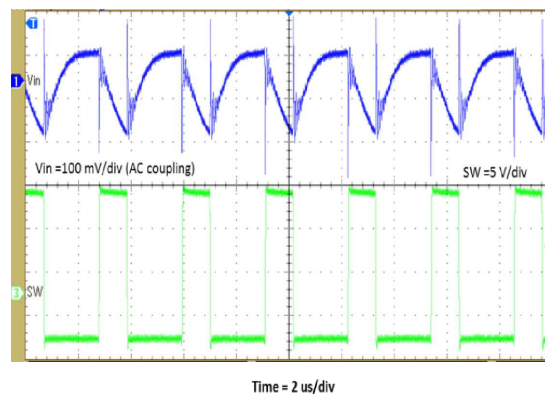

Figure 11. V_{IN} Ripple With $I_{OUT} = 2\text{ A}$

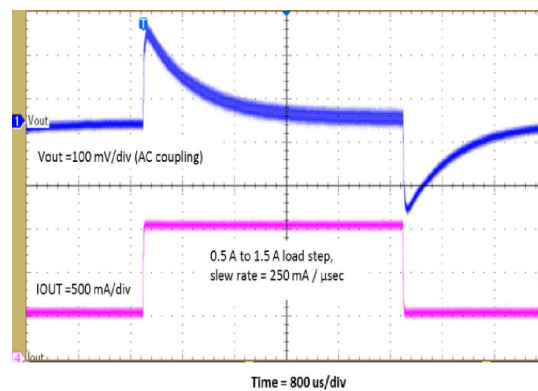

Figure 12. Load Transient

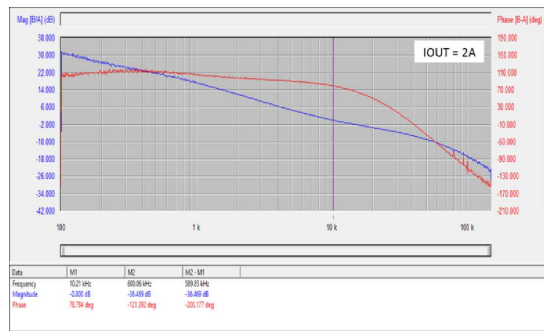

Figure 13. Bode Plot

4 Conclusion

The TPS54335A buck converter can be configured as an inverting buck boost converter to generate a negative output voltage. This application report explains how to select the external components. Measured data from the example design are provided. This application report also applies to the TPS54336A and TPS54334 devices.

5 References

- Texas Instruments, [TPS5433xA 4.5-V to 28-V Input, 3-A Output, Synchronous Step-Down DC-DC Converter](#), data sheet
- Texas Instruments, [Using a Buck Converter in an Inverting Buck-Boost Topology](#), technical brief
- Texas Instruments, [Create an Inverting Power Supply Using a Synchronous Step-Down Regulator](#), application report
- Texas Instruments, [Create an Inverting Power Supply From a Step-Down Regulator](#), application report

Revision History

NOTE: Page numbers for previous revisions may differ from page numbers in the current version.

Changes from July 13, 2017 to July 19, 2017	Page
• Changed R2, L1, and R4 values in <i>12 V to -5 V Reference Design</i> figure	3

IMPORTANT NOTICE FOR TI DESIGN INFORMATION AND RESOURCES

Texas Instruments Incorporated ("TI") technical, application or other design advice, services or information, including, but not limited to, reference designs and materials relating to evaluation modules, (collectively, "TI Resources") are intended to assist designers who are developing applications that incorporate TI products; by downloading, accessing or using any particular TI Resource in any way, you (individually or, if you are acting on behalf of a company, your company) agree to use it solely for this purpose and subject to the terms of this Notice.

TI's provision of TI Resources does not expand or otherwise alter TI's applicable published warranties or warranty disclaimers for TI products, and no additional obligations or liabilities arise from TI providing such TI Resources. TI reserves the right to make corrections, enhancements, improvements and other changes to its TI Resources.

You understand and agree that you remain responsible for using your independent analysis, evaluation and judgment in designing your applications and that you have full and exclusive responsibility to assure the safety of your applications and compliance of your applications (and of all TI products used in or for your applications) with all applicable regulations, laws and other applicable requirements. You represent that, with respect to your applications, you have all the necessary expertise to create and implement safeguards that (1) anticipate dangerous consequences of failures, (2) monitor failures and their consequences, and (3) lessen the likelihood of failures that might cause harm and take appropriate actions. You agree that prior to using or distributing any applications that include TI products, you will thoroughly test such applications and the functionality of such TI products as used in such applications. TI has not conducted any testing other than that specifically described in the published documentation for a particular TI Resource.

You are authorized to use, copy and modify any individual TI Resource only in connection with the development of applications that include the TI product(s) identified in such TI Resource. NO OTHER LICENSE, EXPRESS OR IMPLIED, BY ESTOPPEL OR OTHERWISE TO ANY OTHER TI INTELLECTUAL PROPERTY RIGHT, AND NO LICENSE TO ANY TECHNOLOGY OR INTELLECTUAL PROPERTY RIGHT OF TI OR ANY THIRD PARTY IS GRANTED HEREIN, including but not limited to any patent right, copyright, mask work right, or other intellectual property right relating to any combination, machine, or process in which TI products or services are used. Information regarding or referencing third-party products or services does not constitute a license to use such products or services, or a warranty or endorsement thereof. Use of TI Resources may require a license from a third party under the patents or other intellectual property of the third party, or a license from TI under the patents or other intellectual property of TI.

TI RESOURCES ARE PROVIDED "AS IS" AND WITH ALL FAULTS. TI DISCLAIMS ALL OTHER WARRANTIES OR REPRESENTATIONS, EXPRESS OR IMPLIED, REGARDING TI RESOURCES OR USE THEREOF, INCLUDING BUT NOT LIMITED TO ACCURACY OR COMPLETENESS, TITLE, ANY EPIDEMIC FAILURE WARRANTY AND ANY IMPLIED WARRANTIES OF MERCHANTABILITY, FITNESS FOR A PARTICULAR PURPOSE, AND NON-INFRINGEMENT OF ANY THIRD PARTY INTELLECTUAL PROPERTY RIGHTS.

TI SHALL NOT BE LIABLE FOR AND SHALL NOT DEFEND OR INDEMNIFY YOU AGAINST ANY CLAIM, INCLUDING BUT NOT LIMITED TO ANY INFRINGEMENT CLAIM THAT RELATES TO OR IS BASED ON ANY COMBINATION OF PRODUCTS EVEN IF DESCRIBED IN TI RESOURCES OR OTHERWISE. IN NO EVENT SHALL TI BE LIABLE FOR ANY ACTUAL, DIRECT, SPECIAL, COLLATERAL, INDIRECT, PUNITIVE, INCIDENTAL, CONSEQUENTIAL OR EXEMPLARY DAMAGES IN CONNECTION WITH OR ARISING OUT OF TI RESOURCES OR USE THEREOF, AND REGARDLESS OF WHETHER TI HAS BEEN ADVISED OF THE POSSIBILITY OF SUCH DAMAGES.

You agree to fully indemnify TI and its representatives against any damages, costs, losses, and/or liabilities arising out of your non-compliance with the terms and provisions of this Notice.

This Notice applies to TI Resources. Additional terms apply to the use and purchase of certain types of materials, TI products and services. These include; without limitation, TI's standard terms for semiconductor products (<http://www.ti.com/sc/docs/stdterms.htm>), [evaluation modules](#), and [samples](http://www.ti.com/sc/docs/sampterm.htm) (<http://www.ti.com/sc/docs/sampterm.htm>).

Mailing Address: Texas Instruments, Post Office Box 655303, Dallas, Texas 75265
Copyright © 2017, Texas Instruments Incorporated