

TPS542A50 SWIFT™ Step-Down Converter Evaluation Module User's Guide



ABSTRACT

This user's guide describes the characteristics, operation, and use of the TPS542A50EVM-059 evaluation module (EVM). The user's guide includes test information, descriptions, and results. A complete schematic diagram, printed-circuit board layout, and bill of materials are also included in this document. Throughout this user's guide, the abbreviations *EVM*, *TPS542A50EVM*, and the term *evaluation module* are synonymous with the TPS542A50EVM-059, unless otherwise noted.

Table of Contents

1 Introduction	3
1.1 Before You Begin.....	3
2 Description	4
2.1 Typical End-User Applications.....	4
2.2 EVM Features.....	4
2.3 TPS542A50EVM-059 PCB.....	4
3 TPS542A50EVM-059 Bottom Circuit	6
3.1 Modifications.....	6
3.2 TPS542A50EVM-059 Bottom Circuit Schematic.....	8
3.3 Test Setup and Results.....	9
4 TPS542A50EVM-059 Top Circuit (Small layout area design)	15
4.1 Modifications.....	15
4.2 TPS542A50EVM-059 Top Circuit (Small Layout Area) Schematic.....	17
4.3 Test Setup and Results.....	18
5 TPS542A50EVM-059 PCB Layout	24
6 List of Materials	32
7 Revision History	34

List of Figures

Figure 2-1. TPS542A50EVM-059 PCB View.....	5
Figure 3-1. TPS542A50EVM-059 Bottom Circuit Schematic.....	8
Figure 3-2. Efficiency - FCCM, $f_{sw} = 1000$ kHz, $T_{amb} = 25^{\circ}\text{C}$	10
Figure 3-3. Power Loss - FCCM, $f_{sw} = 1000$ kHz, $T_{amb} = 25^{\circ}\text{C}$	11
Figure 3-4. Load regulation - FCCM, $f_{sw} = 1000$ kHz, $T_{amb} = -40^{\circ}\text{C}$ to $+105^{\circ}\text{C}$	11
Figure 3-5. Transient response - 2-A to 12-A to 2-A load @10 A/ μs , $\Delta V_{out} = 91.1$ mV, $f_{sw} = 1000$ kHz, FCCM.....	12
Figure 3-6. Loop response - $I_{OUT} = 10$ A, Loop Bandwidth = 120 kHz, Phase Margin = 65°	12
Figure 3-7. Output voltage ripple - 0-A load, $\Delta V_{out} = 12.1$ mV, $f_{sw} = 1000$ kHz, FCCM.....	13
Figure 3-8. Output voltage ripple - 10-A load, $\Delta V_{out} = 12.1$ mV, $f_{sw} = 1000$ kHz, FCCM.....	13
Figure 3-9. Thermal Image - 15-A load, $T_{CASE} = 78.4^{\circ}\text{C}$, $T_{amb} = 25^{\circ}\text{C}$	14
Figure 4-1. TPS542A50EVM-059 Top Circuit Schematic.....	17
Figure 4-2. Efficiency - FCCM, $f_{sw} = 1200$ kHz.....	19
Figure 4-3. Power Loss - FCCM, $f_{sw} = 1200$ kHz.....	20
Figure 4-4. Load regulation - FCCM, $f_{sw} = 1200$ kHz.....	20
Figure 4-5. Line regulation - FCCM, $f_{sw} = 1200$ kHz.....	21
Figure 4-6. Transient response - 5-A to 10-A to 5-A load @5 A/ μs , $\Delta V_{out} = 62.1$ mV, $f_{sw} = 1200$ kHz, FCCM.....	21
Figure 4-7. Loop response - $I_{OUT} = 10$ A, Loop Bandwidth = 105 kHz, Phase Margin = 52°	22
Figure 4-8. Output Voltage Ripple - 0-A load, $\Delta V_{OUT} = 11.6$ mV, $f_{sw} = 1200$ kHz, FCCM.....	22
Figure 4-9. Output Voltage Ripple - 12-A load, $\Delta V_{OUT} = 14.4$ mV, $f_{sw} = 1200$ kHz, FCCM.....	23
Figure 4-10. Start up - 12-A load, $f_{sw} = 1200$ kHz, FCCM.....	23

Figure 5-1. Top-Side Composite View.....	24
Figure 5-2. Bottom-Side Composite View (Viewed From Bottom).....	25
Figure 5-3. Top-Side Layout (Top-Down View).....	26
Figure 5-4. Internal Layer-1 Layout (Top-Down View).....	27
Figure 5-5. Internal Layer-2 Layout (Top-Down View).....	28
Figure 5-6. Internal Layer-3 Layout (Top-Down View).....	29
Figure 5-7. Internal Layer-4 Layout (Top-Down View).....	30
Figure 5-8. Bottom-Side Layout (Top-Down View).....	31

List of Tables

Table 1-1. TPS542A50 Input Voltage and Output Current Summary.....	3
Table 2-1. EVM Input Voltage, Output Voltage, and Output Current Summary.....	4
Table 3-1. Enable Pin Selection.....	7
Table 3-2. Top Circuit Connections and Test Points.....	9
Table 3-3. Bottom Circuit Electrical Performance Specifications.....	9
Table 4-1. Enable Pin Selection.....	16
Table 4-2. Bottom Circuit Connections and Test Points.....	18
Table 4-3. Top Circuit Electrical Performance Specifications.....	18
Table 6-1. TPS542A50EVM-059 List of Materials.....	32

Trademarks

All trademarks are the property of their respective owners.

1 Introduction

The TPS542A50EVM-059 evaluation module (EVM) uses the Texas Instruments TPS542A50 buck converter. The TPS542A50 is a highly integrated high-efficiency synchronous buck converter with differential remote sensing and I²C. It is capable of delivering up to 15 A to a load with output voltages ranging from 0.5 V to 5.5 V. The high-side and low-side switching MOSFETs are integrated in the device package, along with their associated gate drive circuitry.



High efficiency, wide-operating junction temperature, and high output voltage accuracy make the TPS542A50 an excellent choice for applications where high output voltage accuracy across rigorous thermal conditions are required. The rated input voltage, output voltage, and output current range for the TPS542A50 are given in [Table 1-1](#).

Table 1-1. TPS542A50 Input Voltage and Output Current Summary

Converter Part Number	Input Voltage Range	Output Voltage Range	Output Current Range
TPS542A50	4 V to 18 V	0.5 V to 5.5 V	0 A to 15 A

1.1 Before You Begin

The following warnings and cautions are noted for the safety of anyone using or working close to the TPS542A50EVM-059. Observe all safety precautions.

	Warning	The TPS542A50EVM-059 circuit module may become hot during operation due to dissipation of heat. Avoid contact with the board. Follow all applicable safety procedures applicable to your laboratory.
	Caution	Do not leave the EVM powered when unattended.

WARNING

The circuit module has signal traces, components, and component leads on the bottom of the board. This may result in exposed voltages, hot surfaces or sharp edges. Do not reach under the board during operation.

CAUTION

The circuit module may be damaged by over temperature. To avoid damage, monitor the temperature during evaluation and provide cooling, as needed, for your system environment.

CAUTION

Some power supplies can be damaged by application of external voltages. If using more than 1 power supply, check your equipment requirements and use blocking diodes or other isolation techniques as needed to prevent damage to your equipment.

CAUTION

The communication interface is not isolated on the EVM. Be sure no ground potential exists between the computer and the EVM.

2 Description

The TPS542A50EVM-059 is set up to allow the user to easily measure the performance of the TPS542A50 buck converter under a wide range of input voltages and load currents. The EVM features two fully independent circuits.

The first circuit that will be discussed is the lower half, or bottom circuit, of the EVM as described in [Section 3](#), and is denoted by U1. This circuit maximizes efficiency and performance of the TPS542A50 in applications that are less constrained by layout area. The second circuit that will be discussed is the upper half, or top circuit, of the EVM as described in [Section 4](#), and is denoted by U1_2. This circuit highlights the small layout area (17 mm x 14 mm) that is required by the TPS542A50 converter and all external components while still delivering high performance and efficiency for space-critical applications.

The TPS542A50 features fixed-frequency voltage-mode control with user-configurable internal compensation, switching frequency, current limit, and soft-start. It also features selectable pulse-frequency modulation (PFM) for high light-load efficiency. These features can be configured using external resistors, or their respective pins can be shorted to ground and configured using I²C to reduce solution size and BOM count. Optionally, a SYNC pin for PWM control can be synchronized to an external clock for low system noise.

Other features include an enable pin, adjustable under-voltage lockout (UVLO), an open-drain power good indicator, and a typical shutdown quiescent current draw of 12 μ A.

The output voltage is programmable from 0.5 V to 5.5 V, and is set with a resistive divider between SREF and AGND, with the mid-point of the divider being tapped from the VSET pin.

The low $R_{DS(on)}$ switching MOSFETs allow for high efficiency while maintaining low junction temperatures at high levels of output current. The TPS542A50 is capable of delivering 15 A of current to a load with no air flow at ambient temperatures up to 95°C, and up to 14 A with no external air flow at ambient temperatures of 105°C.

The extended operating junction temperature of -40°C to +150°C makes the TPS542A50 an excellent choice for applications with rigorous thermal requirements. Examples of these applications can be seen in [Typical End-User Applications](#).

The rated input voltage, output voltage, and output current of both circuits featured in the TPS542A50EVM-059 are shown in [Table 2-1](#). The nominal input voltage of the EVM is 12 V, and the default output voltage is 1 V.

Table 2-1. EVM Input Voltage, Output Voltage, and Output Current Summary

TPS542A50EVM-059	Input Voltage	Output Voltage	Output Current
Bottom circuit	4 V to 18 V (12 V nominal)	1 V (default)	0 A to 15 A
Top circuit (small layout area)	4 V to 18 V (12 V nominal)	1 V (default)	0 A to 12 A

2.1 Typical End-User Applications

- [Enterprise storage, SSD, NAS](#)
- [Wireless and wired communication infrastructure](#)
- [Industrial PCs, automation, ATE, PLC, video surveillance](#)
- [Enterprise server, switches, routers](#)
- ASIC, SoC, FPGA, DSP core and I/O rails

2.2 EVM Features

- Regulated 1-V output up to 15 A, steady-state output current
- Convenient test points for probing critical waveforms
- Two fully independent circuits
- [USB-TO-GPIO](#) interface for convenient I²C Programming (optional)

2.3 TPS542A50EVM-059 PCB

A top-down 3D view of the TPS542A50EVM-059 is shown in [Figure 2-1](#). Some components are not populated by default. As previously described, the EVM features two fully independent circuits. The layers of the EVM PCB are presented in greater detail in [Section 5](#).

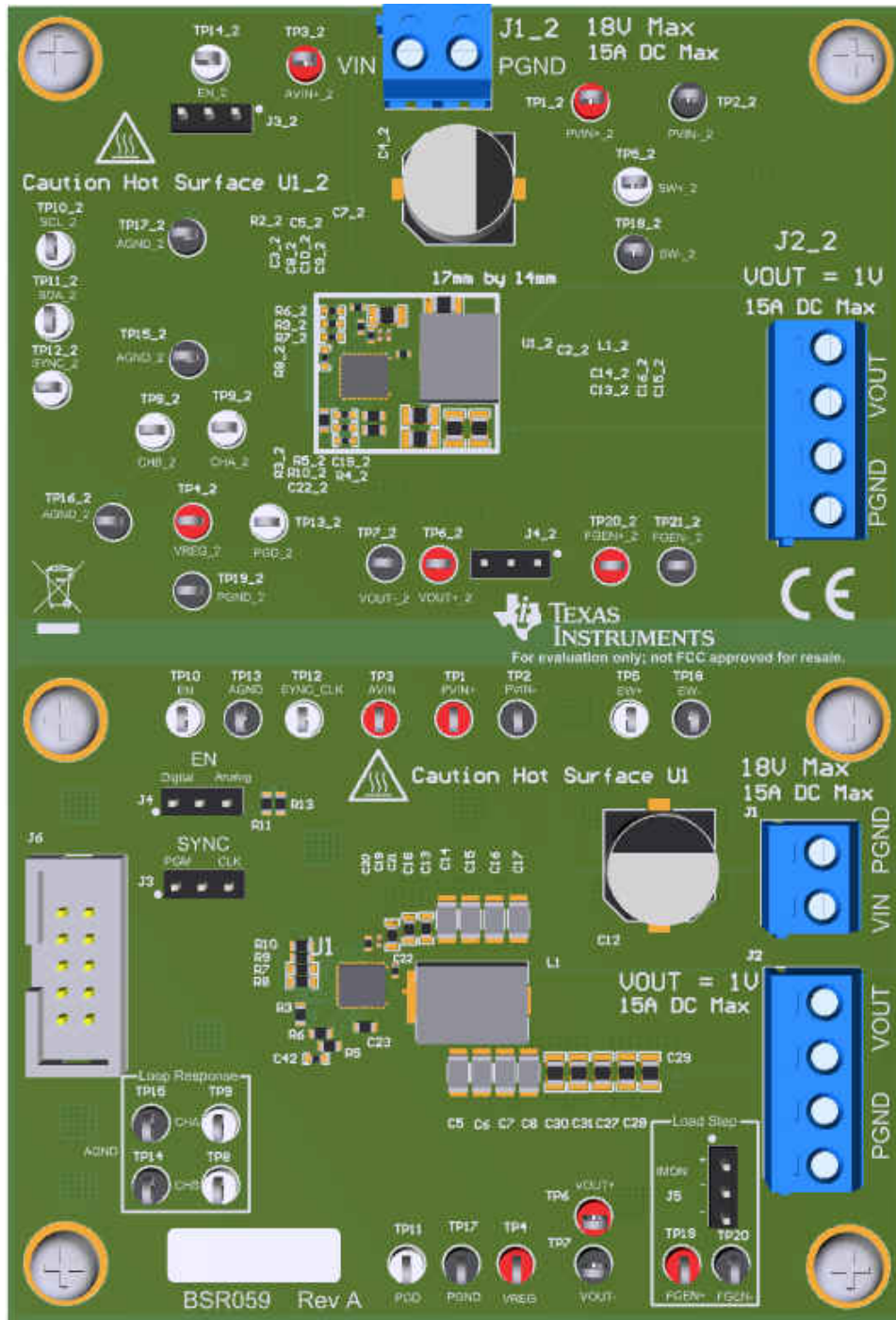

Figure 2-1. TPS542A50EVM-059 PCB View

3 TPS542A50EVM-059 Bottom Circuit

The first circuit that will be discussed is the bottom (lower) circuit on the TPS542A50EVM-059 shown in [Figure 2-1](#). In this circuit, the TPS542A50 converter IC is indicated as "U1". This circuit has been designed to highlight the performance and efficiency of the TPS542A50 across a wide range of operating conditions. The schematic for this circuit is shown in [Figure 3-1](#).

3.1 Modifications

This EVM is designed to provide access to the features of the TPS542A50-EVM. Some of the useful modifications are outline in this section of the user's guide.

3.1.1 Output Voltage Setpoint

The output voltage is set by the resistor divider network of R5 and R6, as shown in [Figure 3-1](#). The divider is connected between SREF and AGND pins, where the mid-point of the divider is tapped to the VSET pin. Unlike many converters, the output voltage is not set by connecting a resistor divider directly to the output node. This allows the use of a differential remote sense for improved output voltage accuracy.

It is recommended to use R5 and R6 in the range of 1 kΩ to 100 kΩ, and the total impedance must be greater than 10 kΩ. A footprint for a small capacitor, C42, has been added for high frequency noise filtering, but is typically not necessary and is not populated by default.

The value of R5 for a desired output voltage, V_{OUT} , can be calculated using [Equation 1](#).

$$R5 = R6 \times \left(\frac{5 \times V_{SREF}}{V_{OUT}} - 1 \right) \quad (1)$$

$$V_{SREF} = 1.2 \text{ V}$$

$$R6 = 20.0 \text{ k}\Omega \text{ (default EVM value)}$$

Note that for output voltages below 1 V, the value of R6 should be reduced to keep R5 and R6 between 1 kΩ and 100 kΩ, while still maintaining a total impedance greater than 10 kΩ.

Using I²C, the TPS542A50 output voltage can be adjusted in 0.25% increments from -20% to +10% of the set output voltage. This allows the tolerance of the resistors used to set the output voltage to be completely eliminated, and gives an output voltage accuracy of -0.5% to +0.5% across the entire temperature range. Note that this adjustment to the output voltage over I²C can only be performed after PGOOD goes high.

3.1.2 Enable and Undervoltage Lockout

The operation of the TPS542A50 can be enabled or disabled using J4. The EN pin of the TPS542A50 is connected to J4-2 (pin 2 of J4) and TP10. The EN pin threshold is 1.2 V. By leaving J4-2 floating, a pullup current source internal to the TPS542A50 enables the device, and the device is operational across all valid input voltages (4 V - 18 V).

Undervoltage lockout (UVLO) can be implemented by connecting a jumper between J4-2 and J4-3. In this configuration, R11 and R13 should be populated according to the TPS542A50 device data sheet based on the desired UVLO requirements. By default, R11 and R13 are not populated.

The TPS542A50 can be disabled by pulling J4-2 (the EN pin) below 1.2 V. When J4-2 is brought below 1.2 V, the regulator stop switching and enters into a low power shutdown mode. This can be accomplished in multiple ways.

The first method is to connect a control signal directly to the EN test point (TP10), referenced to AGND (TP13, TP14, or TP15, recommended between 0 V and 5.5 V). Using this method, a jumper on J4 is not necessary.

Another method is to connect a jumper between J4-1 and J4-2, and connect a control signal to J6-1, or use a [USB-TO-GPIO](#) connected to J6 to control the EN pin.

Default setting: J4 open, EN floating for always-on operation.

Table 3-1. Enable Pin Selection

J4 connection	Enable Selection
J4-2 floating	Device is enabled
J4-2 and J4-3 shorted	UVLO implemented if R11 and R13 are populated - see data sheet for details
J4-1 and J4-2 shorted	Enable can be controlled with external control signal

3.1.3 Programming and External Clock Synchronization

To enter programming mode or use external clock synchronization, J3 is used. To program the TPS542A50, the SYNC pin must be brought high while keeping the EN pin low. The device is then programmed via the I²C pins, SCL (J6-9) and SDA (J6-10). If J6 is used to program the TPS542A50 via a TI [USB-TO-GPIO](#) programmer, a jumper should be placed between J3-1 and J3-2. After the device is enabled, all registers are read-only. Details on the valid I²C registers and instructions are provided in the TPS542A50 data sheet.

An external signal (recommended 0-V to 3.3-V) can be used as an external clock synchronization source. To use this feature, the TPS542A50 must be enabled, either by pulling the EN pin high or leaving it floating as described in [Enable and Undervoltage Lockout](#). A jumper should be placed between J3-2 and J3-3, and the external clock signal should be applied to the SYNC_CLK (TP12) test point, referenced to AGND. The external clock synchronization signal applied to the SYNC pin must also be within -10% to +10% of the configured switching frequency. This is true whether the switching frequency is selected using a resistor from FSEL to AGND (R10), or selected via I²C.

3.1.4 Load Step with Function Generator

The TPS542A50EVM-059 provides a convenient location to connect a function generator for applying load steps to the output. The positive and negative connections of the function generator are applied to FGEN+ (TP19) and FGEN- (TP20), respectively. It is recommended that a 50-Ω termination on the output of the function generator is configured.

The FGEN+ input drives the gate of a [Texas Instruments CSD17527Q5A N-Channel NexFET Power MOSFET](#). Two 0.02-Ω resistors in parallel (R14, R15), connected from the source of the CSD17527Q5A to PGND, provide a 0.01-ohm resistance to measure the voltage across for determining output current, which is nominally equal to 10 mV/A. The voltage across these two resistors is measured from J5-1 and J5-2/3, for the positive and negative terminals, respectively. TI recommends driving the CSD17527Q5A gate with at least 5 V to minimize the R_{DS(on)} of the CSD17527Q5A. The safe operating area of the CSD17527Q5A must be observed at all times when using this feature.

3.2 TPS542A50EVM-059 Bottom Circuit Schematic

The schematic of the bottom circuit of the TPS542A50EVM-059 is shown in Figure 3-1. The components that are not populated by default are shown with a red "X" through them.

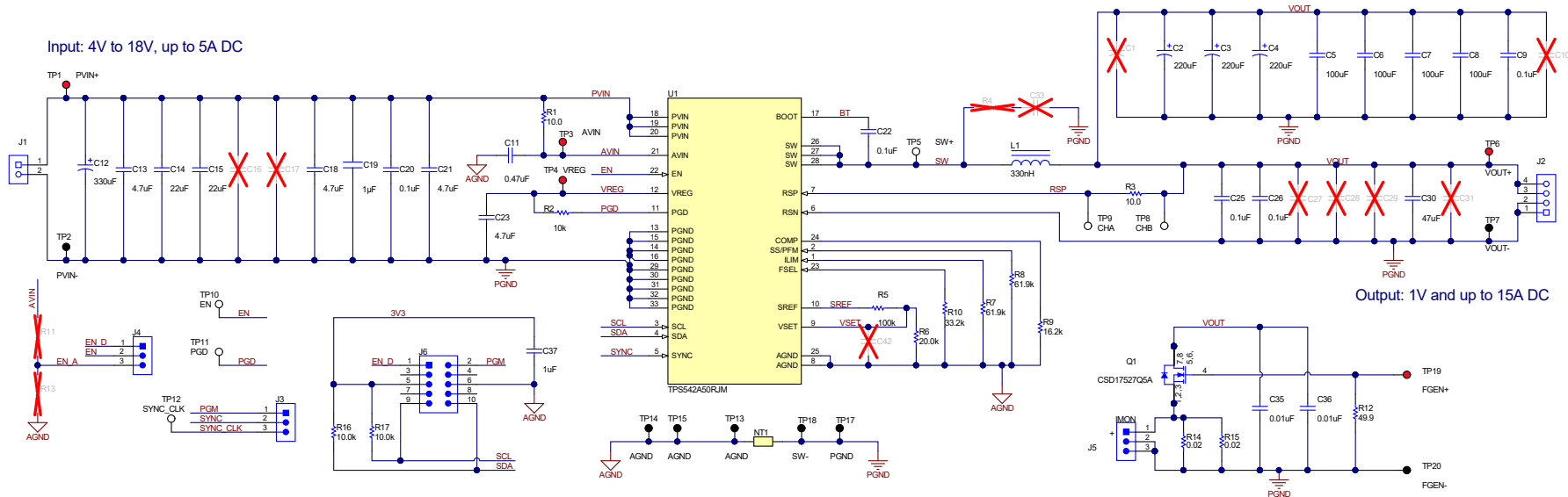

Figure 3-1. TPS542A50EVM-059 Bottom Circuit Schematic

3.3 Test Setup and Results

This section describes how to properly connect, set up, and use the bottom circuit of the TPS542A50EVM-059. This section also includes test results typical for the evaluation module and covers efficiency, power loss, load regulation, transient response, loop response, output voltage ripple, and thermal data. For a more complete set of data, please refer to the TPS542A50 data sheet.

3.3.1 Input/Output Connections

The TPS542A50EVM-059 is provided with input/output connectors and test points as shown in [Table 3-2](#). A power supply capable of supplying at least 5 A at the desired EVM input voltage must be connected to J1 through a pair of 20-AWG or greater wires. The load must be connected to J2 through a pair of 18-AWG or greater wires. The maximum load current capability is 15 A.

Wire lengths must be minimized to reduce losses and parasitic inductance in the wires. PVIN+ (TP1) provides a test point to monitor the VIN input voltages with PVIN- (TP2) providing a convenient reference to PGND. VOUT+ (TP6) is used to monitor the output voltage with VOUT- (TP7) providing a reference to PGND.

Table 3-2. Top Circuit Connections and Test Points

Connection and Test Points	Description
J1	VIN, PGND connection (see Table 1-1 for input voltage range)
J2	VOUT, PGND connection: 5.5 V at 15 A maximum (default is 1 V out at 15 A)
J3	Programming mode and external clock synchronization
J4	Enable configuration
J5	Output current sensing points when using function generator as load control signal
J6	For connecting a TI USB-TO-GPIO programmer
PVIN+ (TP1), PVIN- (TP2)	VIN voltage sensing test points
VOUT+ (TP6), VOUT- (TP7)	VOUT voltage sensing test points
AVIN (TP3)	AVIN voltage sensing test points
VREG (TP4)	VREG voltage sensing test point
SW+ (TP5), SW- (TP18)	SW node sensing test points
CHA (TP9), CHB (TP8)	Loop measurement test points
EN (TP10)	EN pin test point
PGD (TP11)	Open-drain PGD test point
SYNC_CLK (TP12)	For connecting and measuring external clock synchronization
AGND (TP13, TP14, TP15)	AGND connection - multiple provided to reduce oscilloscope ground probe loop inductance
PGND (TP17)	PGND connection
FGEN+ (TP19), FGEN- (TP20)	Function generator connection points - referenced to PGND

3.3.2 Start Up Procedure

1. Make sure the EN jumper (J4) is open to float the EN pin, enabling the TPS542A50. Alternatively, the device can be enabled as described in [Enable and Undervoltage Lockout](#).
2. If using an external load, connect the load to VOUT and PGND of J2 using copper wire capable of handling at least 15 A (18-AWG or greater). If using the built-in load with a function generator, connect the positive and negative connections of the function generator to FGEN+ (TP19) and FGEN- (TP20), respectively.
3. Apply appropriate VIN voltage to the VIN and PGND terminals of J1.

3.3.3 Electrical Performance Specifications and Results

The typical electrical performance specifications of the TPS542A50EVM bottom circuit are shown in [Table 3-3](#). Unless stated otherwise, the measurements were taken with the converter operating in FCCM and $T_{AMB} = 25^{\circ}\text{C}$.

Table 3-3. Bottom Circuit Electrical Performance Specifications

PARAMETER	TEST CONDITIONS	MIN	TYP	MAX	UNITS
V_{IN} voltage range		5	12	14	V

Table 3-3. Bottom Circuit Electrical Performance Specifications (continued)

PARAMETER	TEST CONDITIONS	MIN	TYP	MAX	UNITS
Output voltage			1		V
Output current range		0		15	A
Load regulation	$V_{IN} = 12\text{ V}$, $I_O = 0\text{ A}$ to 15 A, FCCM	-0.2		+0.2	%
ΔV_{OUT} , total undershoot/overshoot	$V_{IN} = 12\text{ V}$, $I_O = 2\text{-A}$ to 12-A to 2-A load step @ 10 A/ μs		91		mV
Loop bandwidth	$V_{IN} = 12\text{ V}$, $I_O = 10\text{ A}$		120		kHz
Phase margin	$V_{IN} = 12\text{ V}$, $I_O = 10\text{ A}$		65		°
Output voltage ripple	$V_{IN} = 12\text{ V}$, $I_O = 0\text{ A}$		12.1		mV
	$V_{IN} = 12\text{ V}$, $I_O = 10\text{ A}$		12.1		mV
IC case temperature	$V_{IN} = 12\text{ V}$, $I_O = 15\text{ A}$, $T_{amb} = 25\text{C}$		78.4		°C
Switching frequency	FCCM		1000		kHz

3.3.4 Efficiency

Figure 3-2 shows the efficiency of the TPS542A50EVM-059 when operating in forced continuous-conduction mode (FCCM). The light-load efficiency can be improved by operating the converter in DCM as described in the TPS542A50 data sheet. The default setting on the EVM is FCCM operation.

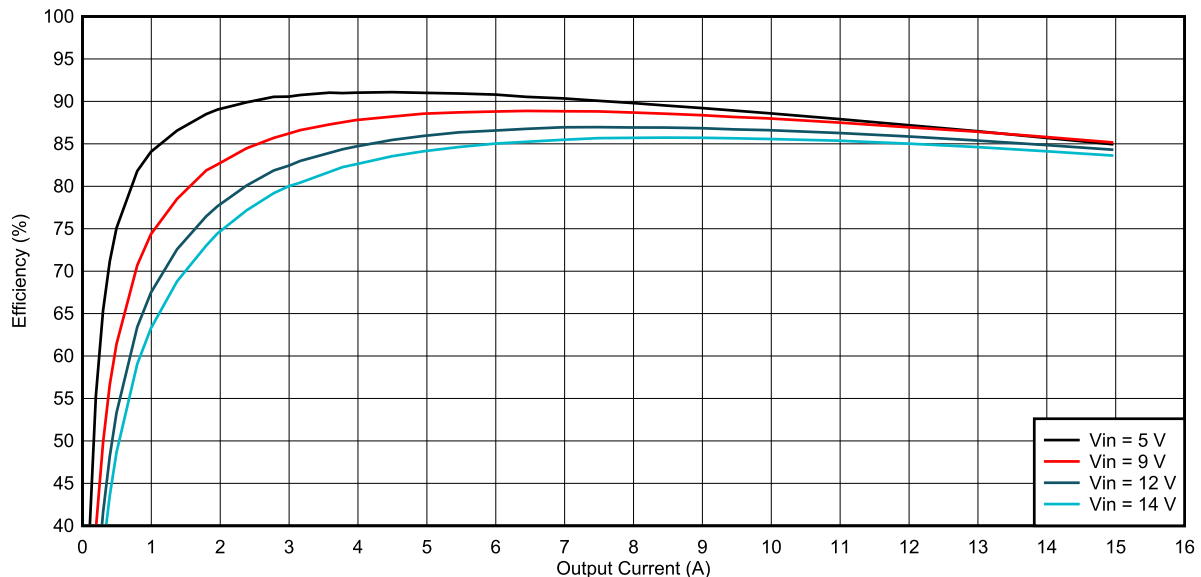
Figure 3-2. Efficiency - FCCM, $f_{sw} = 1000\text{ kHz}$, $T_{amb} = 25^\circ\text{C}$

3.3.5 Power Loss

The power loss of the bottom circuit when operating in FCCM is shown in Figure 3-3. The power loss includes all losses of the converter, including the losses of the output inductor.

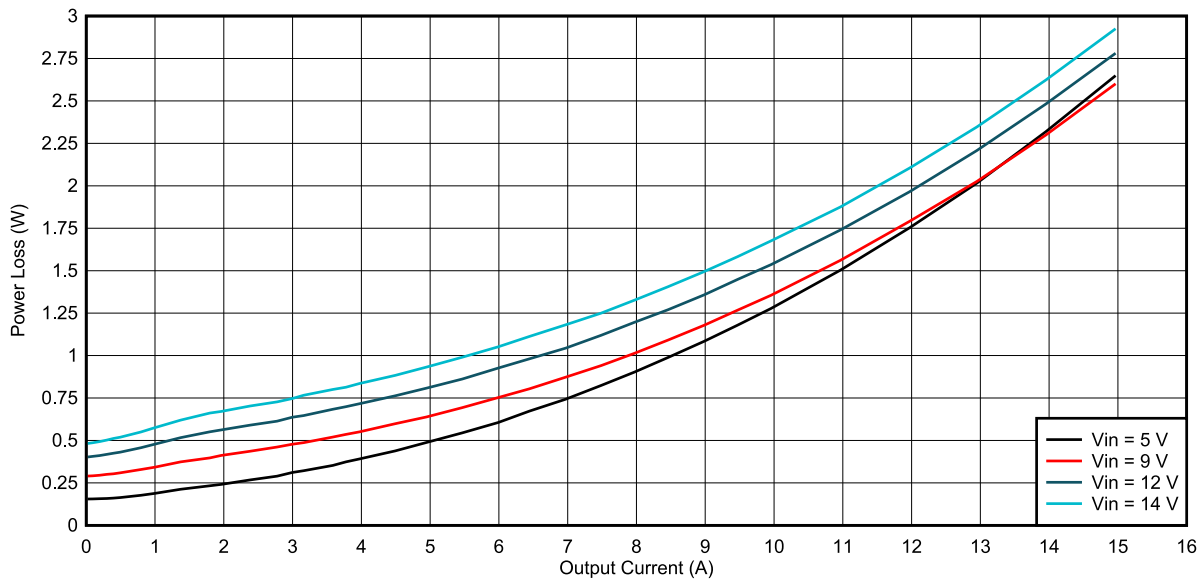

Figure 3-3. Power Loss - FCCM, $f_{sw} = 1000 \text{ kHz}$, $T_{amb} = 25^\circ\text{C}$

3.3.6 Load Regulation

The EVM bottom circuit load regulation for ambient temperatures of -40°C to $+105^\circ\text{C}$ and input voltages of 5 V and 12 V is shown in Figure 3-4.

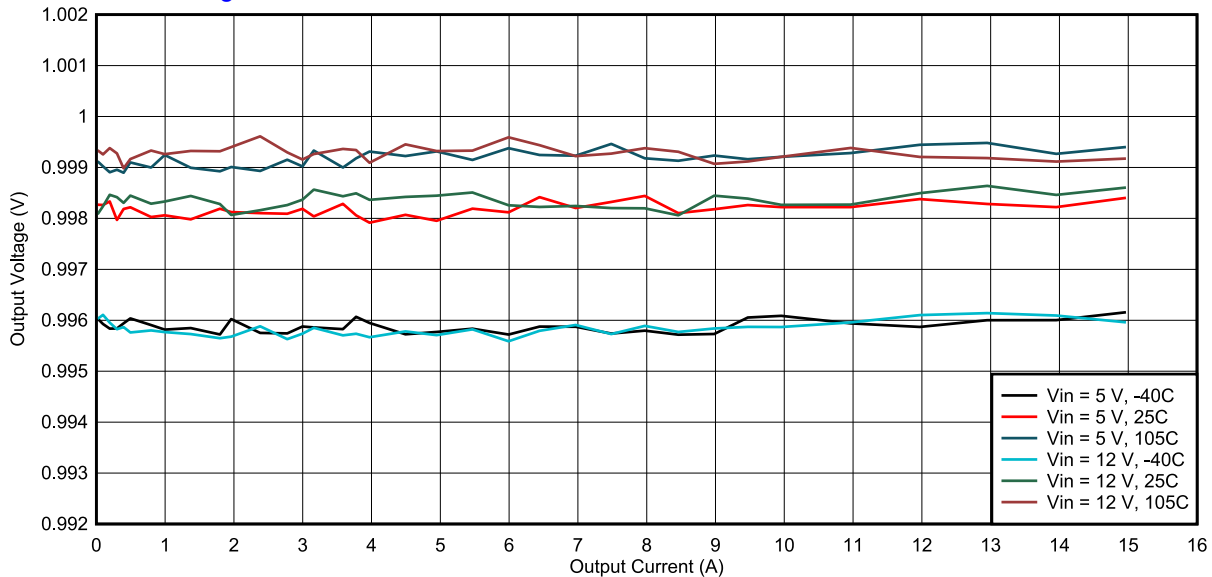

Figure 3-4. Load regulation - FCCM, $f_{sw} = 1000 \text{ kHz}$, $T_{amb} = -40^\circ\text{C}$ to $+105^\circ\text{C}$

3.3.7 Transient Response

Figure 3-5 shows the transient response of the converter when operating in FCCM. The total undershoot and overshoot in response to a 10-A load transient (2-A to 12-A to 2-A) with a slew rate of $10 \text{ A}/\mu\text{s}$ is 91.1 mV.

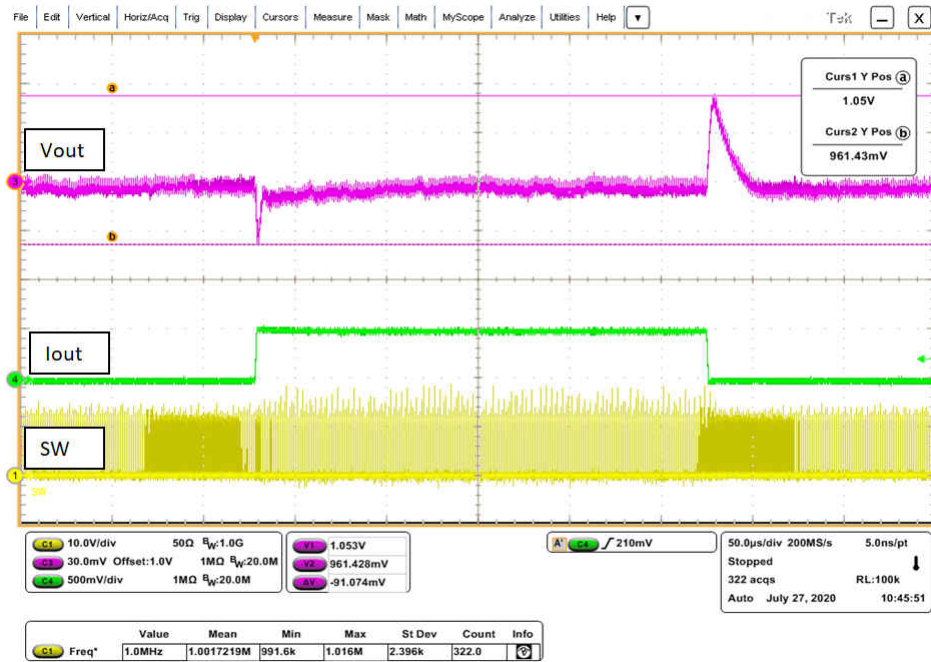

Figure 3-5. Transient response - 2-A to 12-A to 2-A load @10 A/ μ s, Δ Vout = 91.1 mV, $f_{sw} = 1000$ kHz, FCCM

3.3.8 Loop Response

The loop response of the bottom circuit of the TPS542A50EVM-059 with a 10-A load is shown in Figure 3-6. The bandwidth of the loop is 120 kHz, and the phase margin is 65°.

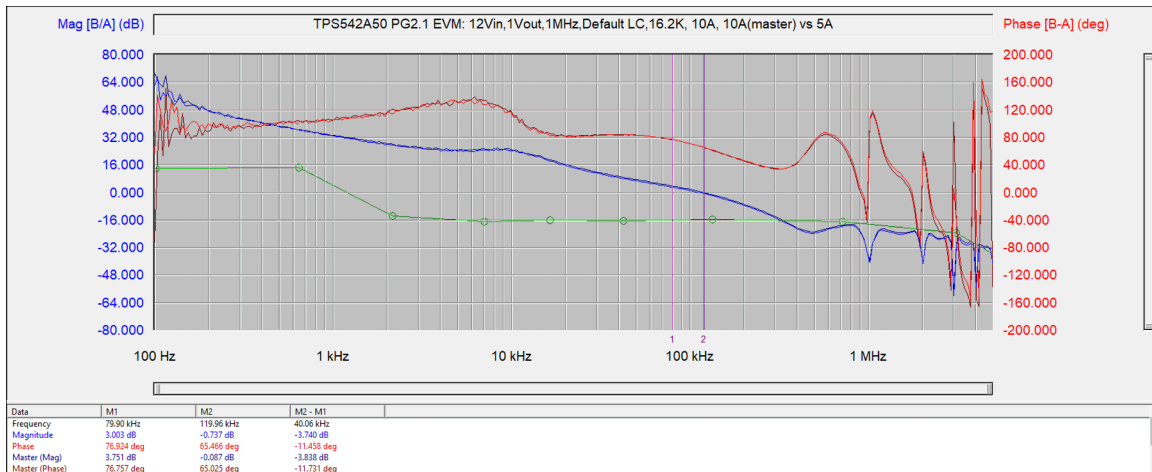

Figure 3-6. Loop response - $I_{OUT} = 10$ A, Loop Bandwidth = 120 kHz, Phase Margin = 65°

3.3.9 Output Voltage Ripple

Figure 3-7 shows an output voltage ripple of 12.1 mV with a load of 0 A. Figure 3-8 shows an output voltage ripple of 12.1 mV with a load of 10 A.

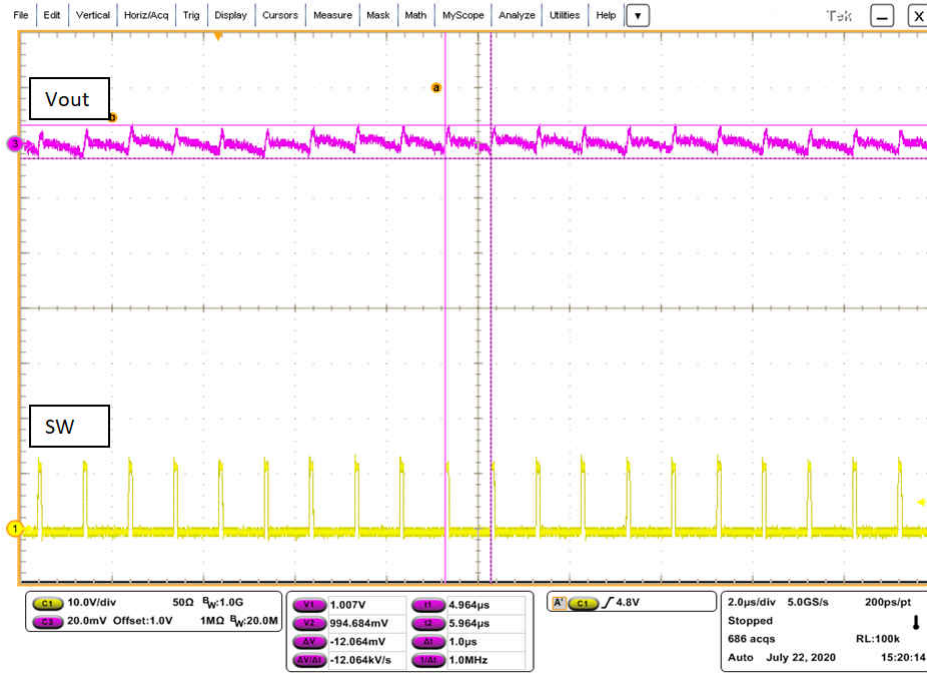

Figure 3-7. Output voltage ripple - 0-A load, $\Delta V_{out} = 12.1 \text{ mV}$, $f_{sw} = 1000 \text{ kHz}$, FCCM

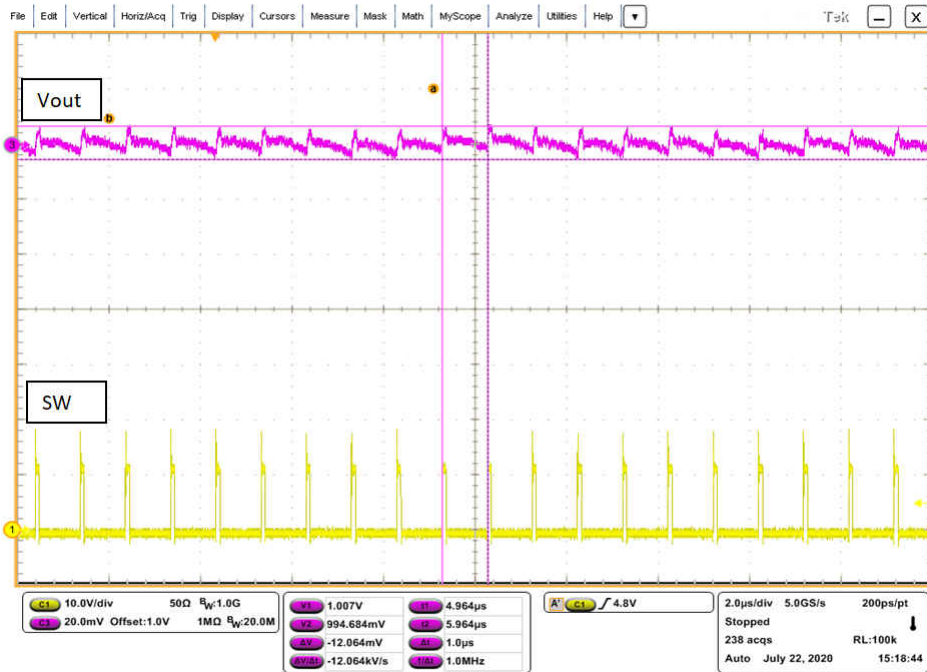

Figure 3-8. Output voltage ripple - 10-A load, $\Delta V_{out} = 12.1 \text{ mV}$, $f_{sw} = 1000 \text{ kHz}$, FCCM

3.3.10 Thermal Data

Figure 3-9 shows a thermal image of the TPS542A50 operating at a load current of 15 A and $T_{amb} = 25^\circ\text{C}$. The IC case temperature is 78.4°C .



Figure 3-9. Thermal Image - 15-A load, $T_{CASE} = 78.4^{\circ}\text{C}$, $T_{amb} = 25^{\circ}\text{C}$

4 TPS542A50EVM-059 Top Circuit (Small layout area design)

The second circuit that will be discussed is the top (upper) circuit on the TPS542A50EVM-059 shown in [Figure 2-1](#). In this circuit, the TPS542A50 converter IC is indicated as U1_2. This circuit has been designed with a minimal layout area for applications where space is limited. The default switching frequency is 1.2 MHz, which allows for the use of smaller output inductance and capacitance. The converter and all associated components fit inside a 17 mm x 14 mm layout area (238 mm²) while still delivering high performance for space-critical applications.

4.1 Modifications

This EVM is designed to provide access to the features of the TPS542A50EVM-059. Some of the useful modifications are outline in this section of the user's guide.

4.1.1 Output Voltage Setpoint

The output voltage is set by the resistor divider network of R5_2 and R10_2, as shown in [Figure 4-1](#). The divider is connected between SREF and AGND pins, where the mid-point of the divider is tapped to the VSET pin. Unlike many converters, the output voltage is not set by connecting a resistor divider directly to the output node. This allows the use of a differential remote sense for improved output voltage accuracy.

It is recommended to use R5_2 and R10_2 in the range of 1 kΩ to 100 kΩ, and the total impedance must be greater than 10 kΩ. A footprint for a small capacitor, C22_2, has been added for high frequency noise filtering, but is typically not necessary and is not populated by default..

The value of R5_2 for a desired output voltage, V_{OUT} , can be calculated using [Equation 2](#).

$$R5_2 = R10_2 \times \left(\frac{5 \times V_{SREF}}{V_{OUT}} - 1 \right) \quad (2)$$

$$V_{SREF} = 1.2 \text{ V}$$

$$R10_2 = 20.0 \text{ k}\Omega$$

Note that for V_{out} below 1 V, the value of R10_2 should be reduced to keep R5_2 and R10_2 between 1 kΩ and 100 kΩ, while still maintaining a total impedance greater than 10 kΩ.

Using I²C, the TPS542A50 output voltage can be adjusted in 0.25% increments from -20% to +10% of the set output voltage. This allows the tolerance of the resistors used to set the output voltage to be completely eliminated, and gives an output voltage accuracy of -0.5% to +0.5% across the entire temperature range. Note that this adjustment to the output voltage over I²C can only be performed after PGOOD goes high.

4.1.2 Enable and Undervoltage Lockout

The operation of the TPS542A50 can be enabled or disabled using J3_2. The EN pin of the TPS542A50 is connected to J3_2-2 (pin 2 of J3_2) and TP14_2. The EN pin threshold is 1.2 V. By leaving J3_2-2 floating, a pullup current source internal to the TPS542A50 enables the device, and the device is operational across all valid input voltages (4 V - 18 V).

Undervoltage lockout (UVLO) can be implemented by connecting a jumper between J3_2-2 and J3_2-3. In this configuration, R12_2 and R15_2 should be populated according to the TPS542A50 device data sheet based on the desired UVLO requirements. By default, R12_2 and R15_2 are not populated.

The TPS542A50 can be disabled by pulling J3_2-2 (the EN pin) below 1.2 V. When J3_2-2 is brought below 1.2 V, the regulator stop switching and enters into a low power shutdown mode.

To externally control the EN pin of the TPS542A50, a control signal referenced to AGND (TP15_2, TP16_2, or TP17_2, recommended between 0 V and 5.5 V) can be connected directly to the EN_2 test point (TP14_2). Using this method, a jumper on J3_2 is not necessary.

The converter can be put into shutdown mode manually by connecting a jumper between J3_2-2 and J3_2-1, which grounds the EN pin.

Default setting: J3_2 open, EN floating for always-on operation.

Table 4-1. Enable Pin Selection

J3_2 connection	Enable Selection
J3_2-2 floating	Device is enabled
J3_2-2 and J3_2-3 shorted	UVLO implemented if R12_2 and R15_2 are populated - see data sheet for details
J3_2-1 and J3_2-2 shorted	Converter is disabled

4.1.3 Programming and External Clock Synchronization

To enter programming mode, the SYNC pin (TP12_2) must be brought high while keeping the EN pin (J3_2-2 or TP14_2) low. The device is then programmed via the I²C pins (SCL and SDA). In this circuit, the SCL pin is connected to TP10_2, and the SDA pin is connected to TP11_2. After the device is enabled, all registers are read-only. Details on the valid I²C registers and instructions are provided in the TPS542A50 data sheet.

Note

This circuit does not have I²C pull-up resistors and must be provided by externally or by the I²C master device. The maximum recommended I²C pull-up voltage is 5.5 V.

An external signal (recommended 0-V to 3.3-V) can be used as an external clock synchronization source. To use this feature, the TPS542A50 must be enabled by bringing the EN pin (J3_2-2 or TP14_2) high, or leaving it floating. The external clock synchronization signal should be applied to the SYNC (TP12_2) pin, referenced to AGND. The external clock synchronization source must also be within -10% to +10% of the set switching frequency. This is true whether the switching frequency is selected using a resistor from FSEL to AGND (R6_2), or selected via I²C.

4.1.4 Load Step with Function Generator

The TPS542A50EVM-059 has a built-in load that can be controlled using the function generator inputs, FGEN+_2 (TP20_2) and FGEN-_2 (TP21_2). The positive connection of the function generator output is connected to FGEN+_2, and the negative connection of the function generator is connected to FGEN-_2. It is recommended that a 50-Ω termination on the output of the function generator is configured.

The FGEN+_2 input drives the gate of a [Texas Instruments CSD17527Q5A N-channel NexFET Power MOSFET](#). Two 0.02-ohm resistors in parallel (R13_2, R14_2), connected from the source of the CSD17527Q5A to PGND, provide a 0.01-ohm resistance to measure the voltage across to determine output current, which is equal to approximately 10 mV/A. The voltage across these two resistors is measured from J4_2-1 and J4_2-2/3, for the positive and negative terminals, respectively. TI recommends driving the CSD17527Q5A gate with at least 5 V to minimize R_{DS(on)} of the CSD17527Q5A. The safe operating area of the CSD17527Q5A must always be observed when using this feature.

4.2 TPS542A50EVM-059 Top Circuit (Small Layout Area) Schematic

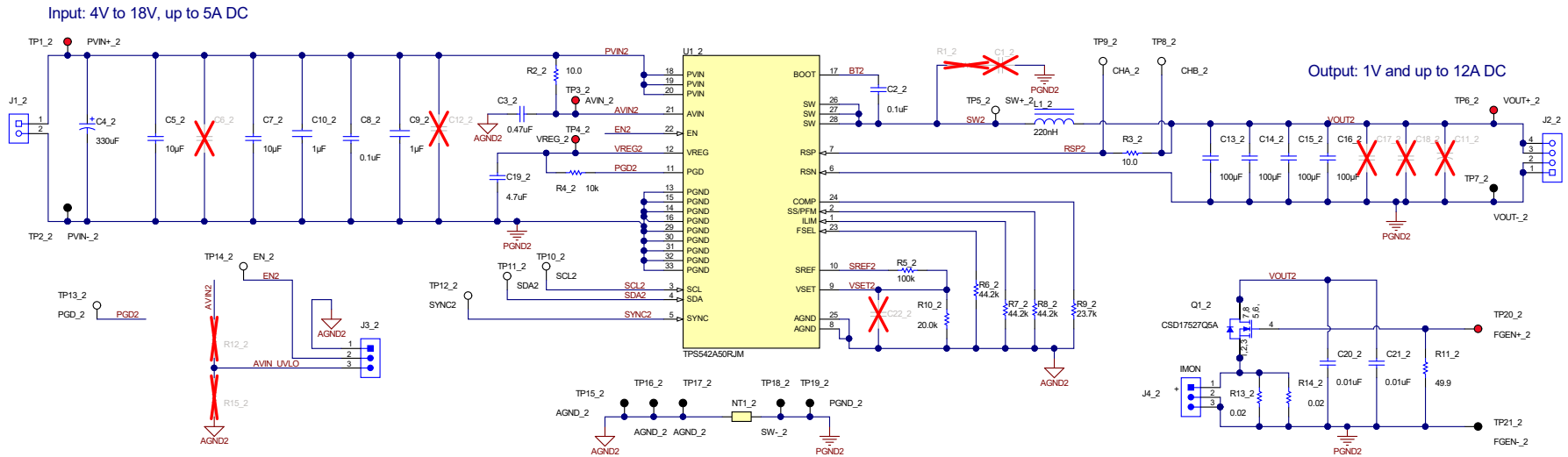

Figure 4-1. TPS542A50EVM-059 Top Circuit Schematic

4.3 Test Setup and Results

This section describes how to properly connect, set up, and use the top circuit of the TPS542A50EVM-059. This section also includes test results typical for the evaluation module and covers efficiency, power loss, load regulation, line regulation, transient response, loop response, output voltage ripple, and start up. For a more complete set of data, please consult the TPS542A50 data sheet.

4.3.1 Input/Output Connections

The TPS542A50EVM-059 is provided with input/output connectors and test points as shown in [Table 4-2](#). A power supply capable of supplying at least 5 A at the desired EVM input voltage must be connected to J1_2 through a pair of 20-AWG or greater wires. The load must be connected to J2_2 through a pair of 18-AWG or greater wires. The maximum load current capability of the top circuit is 12 A, as limited by R7_2.

Wire lengths must be minimized to reduce losses and parasitic inductance in the wires. PVIN+ _2 (TP1_2) provides a test point to monitor the VIN input voltages with PVIN- _2 (TP2_2) providing a convenient reference to PGND. VOUT+ _2 (TP6_2) is used to monitor the output voltage with VOUT- _2 (TP7_2) providing a reference to PGND.

Table 4-2. Bottom Circuit Connections and Test Points

Connection and Test Points	Description
J1_2	VIN, PGND connection (see Table 1-1 for input voltage range)
J2_2	VOUT, PGND connection: 5.5 V at 15 A maximum (default is 1 V out at 12 A)
J3_2	Enable configuration
J4_2	Output current sensing points when using function generator as load control signal
PVIN+ _2 (TP1_2), PVIN- _2 (TP2_2)	VIN voltage sensing test points
VOUT+ _2 (TP6_2), VOUT- _2 (TP7_2)	VOUT voltage sensing test points
AVIN_2 (TP3_2)	AVIN voltage sensing test points
VREG_2 (TP4_2)	VREG voltage sensing test point
SW+ _2 (TP5_2), SW- _2 (TP18_2)	SW node sensing test points
CHA_2 (TP9_2), CHB_2 (TP8_2)	Loop measurement test points
SCL2 (TP10_2), SDA2 (TP11_2)	I ² C connections
EN_2 (TP14_2)	EN pin test point
PGD_2 (TP13_2)	Open-drain PGD test point
SYNC2 (TP12_2)	For connecting and measuring external clock synchronization
AGND_2 (TP15_2, TP16_2, TP17_2)	AGND connection - multiple provided to reduce oscilloscope ground probe loop inductance
PGND_2 (TP18_2, TP19_2)	PGND connection
FGEN+ _2 (TP20_2), FGEN- _2 (TP21_2)	Function generator connection points - referenced to PGND

4.3.2 Start Up Procedure

1. Make sure the EN jumper (J3_2) is open to float the EN pin, enabling the TPS542A50.
2. If using an external load, connect the load to VOUT and PGND of J2_2 using copper wire capable of handling at least 15 A (18-AWG or greater). If using the built-in load with a function generator, connect the positive and negative connections of the function generator to FGEN+ _2 (TP20_2) and FGEN- _2 (TP21_2), respectively.
3. Apply appropriate VIN voltage to the VIN and PGND terminals of J1_2.

4.3.3 Electrical Performance Specifications and Results

The typical electrical performance specifications of the TPS542A50EVM top circuit are shown in [Table 4-3](#). Unless stated otherwise, the measurements were taken with the converter operating in FCCM and T_{AMB} = 25°C.

Table 4-3. Top Circuit Electrical Performance Specifications

PARAMETER	TEST CONDITIONS	MIN	TYP	MAX	UNITS
V _{IN} voltage range		5	12	14	V

Table 4-3. Top Circuit Electrical Performance Specifications (continued)

PARAMETER	TEST CONDITIONS	MIN	TYP	MAX	UNITS
I _{IN} input current	V _{IN} = 12 V, I _O = 0 A		35		mA
	V _{IN} = 12 V, I _O = 12 A		1190		
Output voltage			1		V
Output current range		0		12	A
Load regulation	V _{IN} = 12 V, I _O = 0 A to 12 A,	-0.2		+0.2	%
Line regulation	V _{IN} = 5 V to 14 V, I _O = 0 A	-0.2		+0.2	%
	V _{IN} = 5 V to 14 V, I _O = 12 A	-0.2		+0.2	%
ΔV _{OUT} , total overshoot/undershoot	V _{IN} = 12 V, I _O = 5-A to 10-A to 5-A load step @ 5A/μs		62.1		mV
Loop bandwidth	V _{IN} = 12 V, I _O = 10 A		105		kHz
Phase margin			52		
Output voltage ripple	V _{IN} = 12 V, I _O = 0 A		11.6		mV
	V _{IN} = 12 V, I _O = 12 A		14.4		
Switching frequency	FCCM		1200		kHz

4.3.4 Efficiency

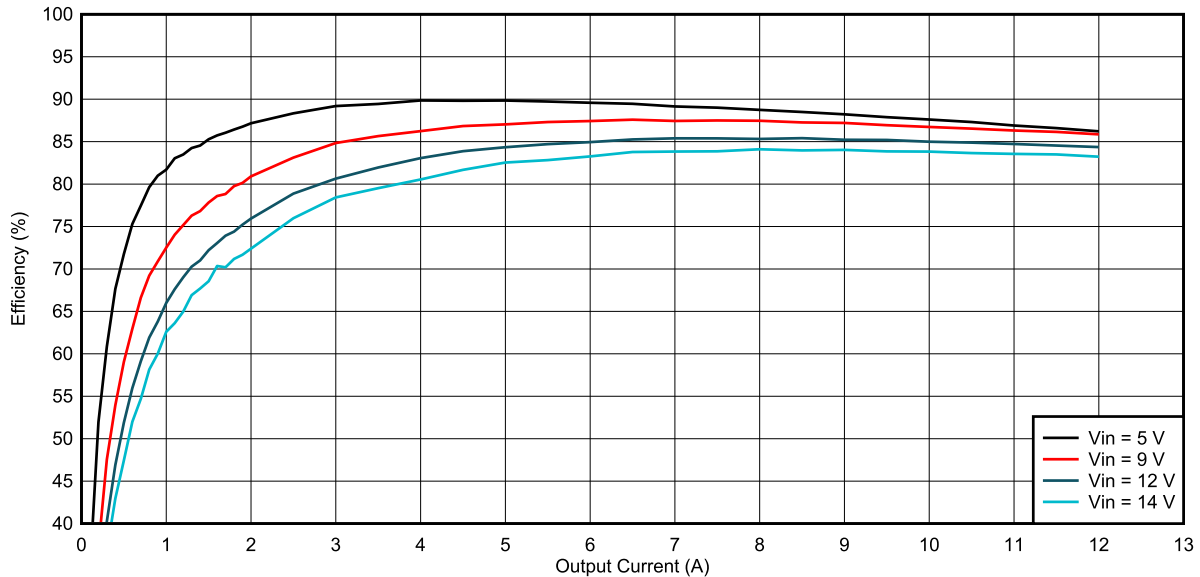

Figure 4-2. Efficiency - FCCM, f_{sw} = 1200 kHz

4.3.5 Power Loss

The power loss of the circuit is shown in [Figure 4-3](#). The losses of the top circuit are slightly higher due to the increased switching losses associated with a higher switching frequency.

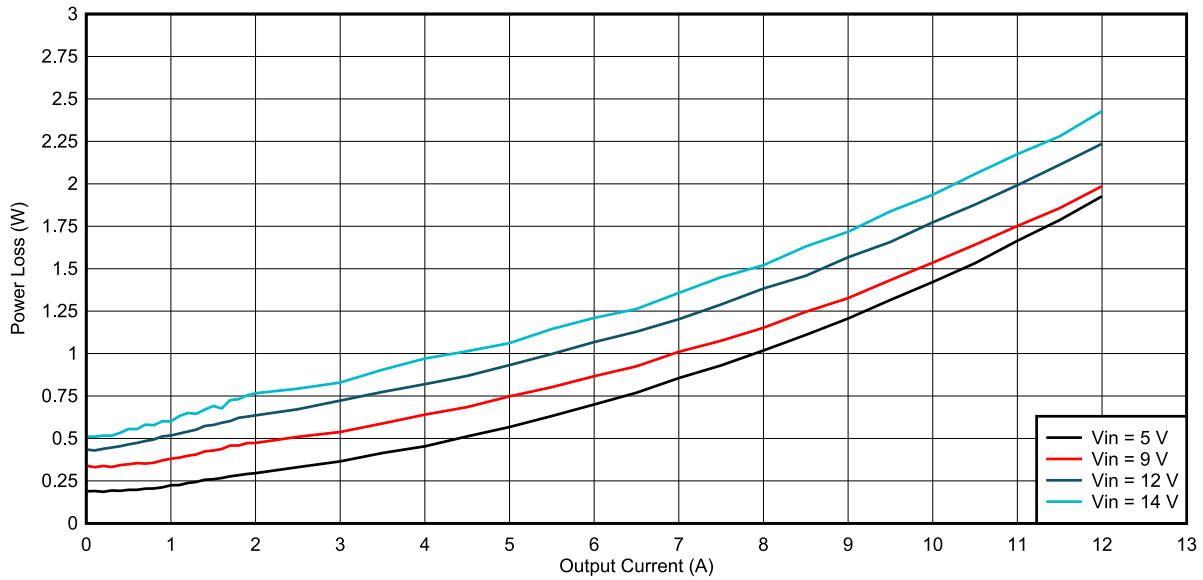

Figure 4-3. Power Loss - FCCM, $f_{sw} = 1200$ kHz

4.3.6 Load Regulation

The load regulation for $V_{IN} = 5$ V to 14 V is shown in Figure 4-4.

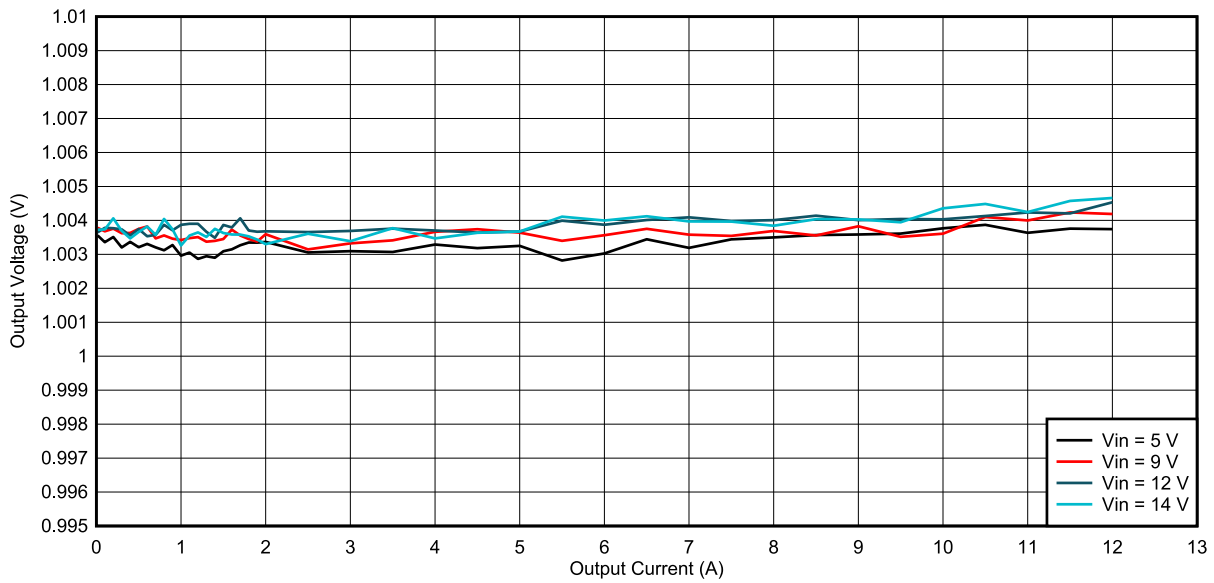

Figure 4-4. Load regulation - FCCM, $f_{sw} = 1200$ kHz

4.3.7 Line Regulation

The line regulation for output currents of 0 A, 7 A, and 12 A is shown in Figure 4-5.

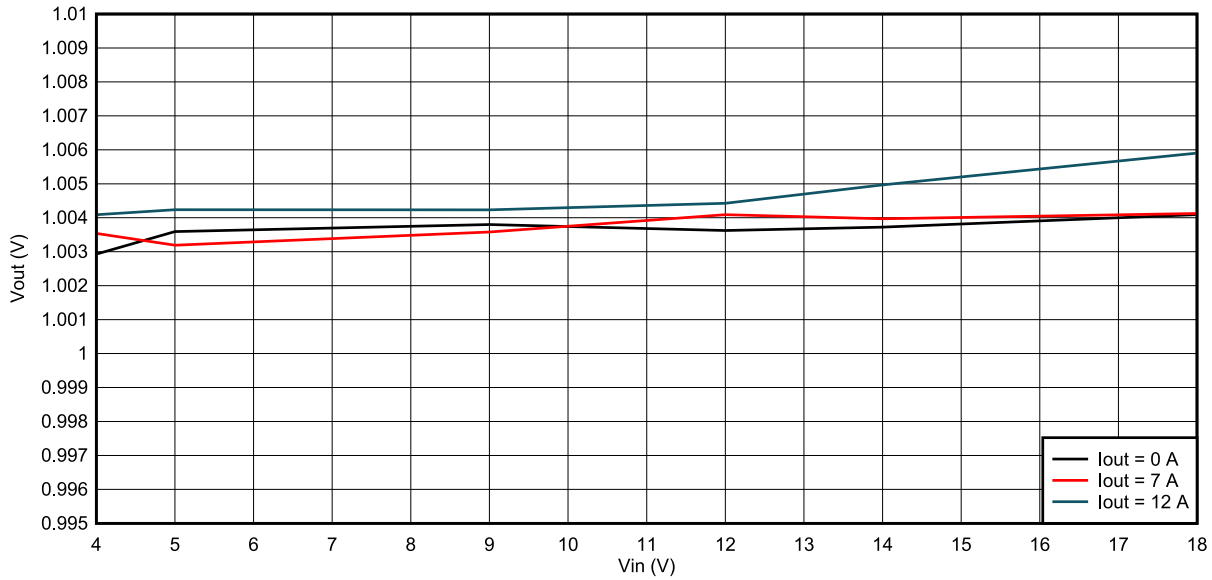

Figure 4-5. Line regulation - FCCM, $f_{sw} = 1200$ kHz

4.3.8 Transient Response

Figure 4-6 shows the transient response of the converter when operating in FCCM. The total undershoot and overshoot in response to a 5-A load transient (5-A to 10-A to 5-A) with a slew rate of $5 \text{ A}/\mu\text{s}$ is 62.1 mV .



Figure 4-6. Transient response - 5-A to 10-A to 5-A load @ $5 \text{ A}/\mu\text{s}$, $\Delta V_{out} = 62.1 \text{ mV}$, $f_{sw} = 1200$ kHz, FCCM

4.3.9 Loop Response

The loop response of the top circuit of the TPS542A50EVM-059 with a 10-A load is shown in Figure 4-7. The bandwidth of the loop is 105 kHz , and the phase margin is 52° .

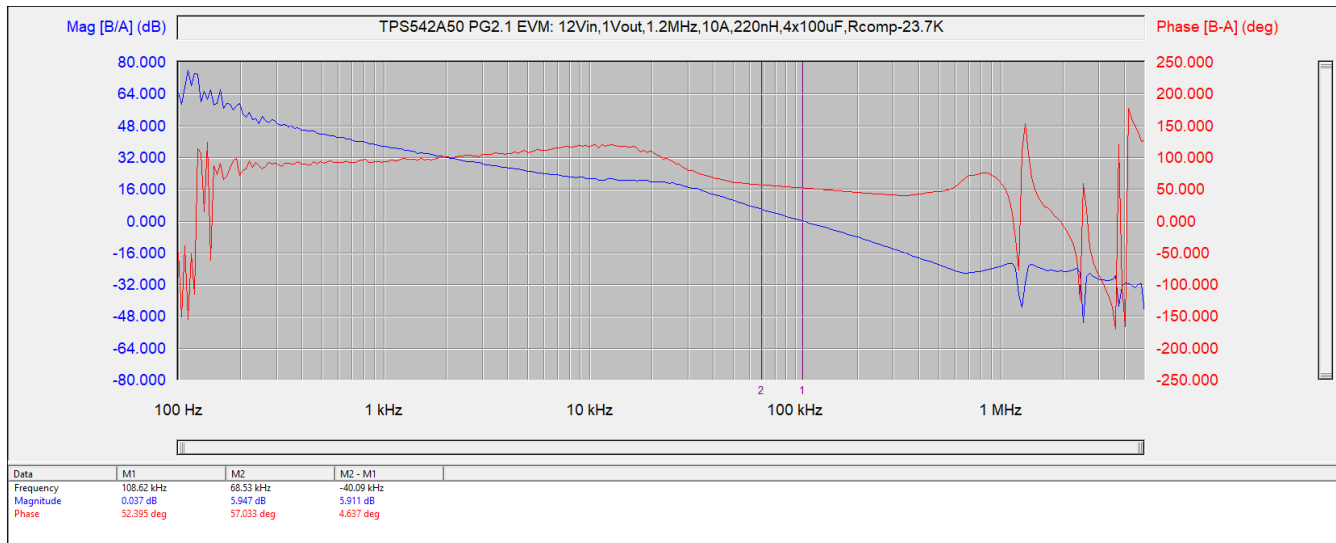

Figure 4-7. Loop response - $I_{OUT} = 10\text{ A}$, Loop Bandwidth = 105 kHz, Phase Margin = 52°

4.3.10 Output Voltage Ripple

Figure 4-8 shows an output voltage ripple with a 0-A load, and Figure 4-9 shows the output voltage ripple with a 12-A load.

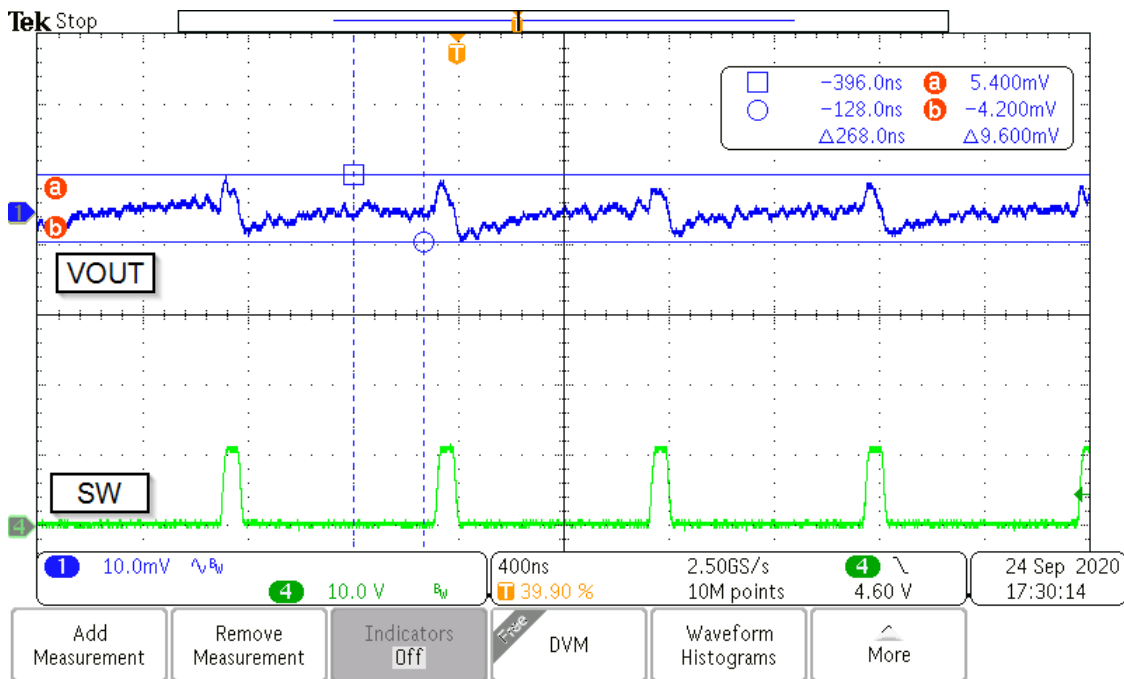

Figure 4-8. Output Voltage Ripple - 0-A load, $\Delta V_{OUT} = 11.6\text{ mV}$, $f_{sw} = 1200\text{ kHz}$, FCCM

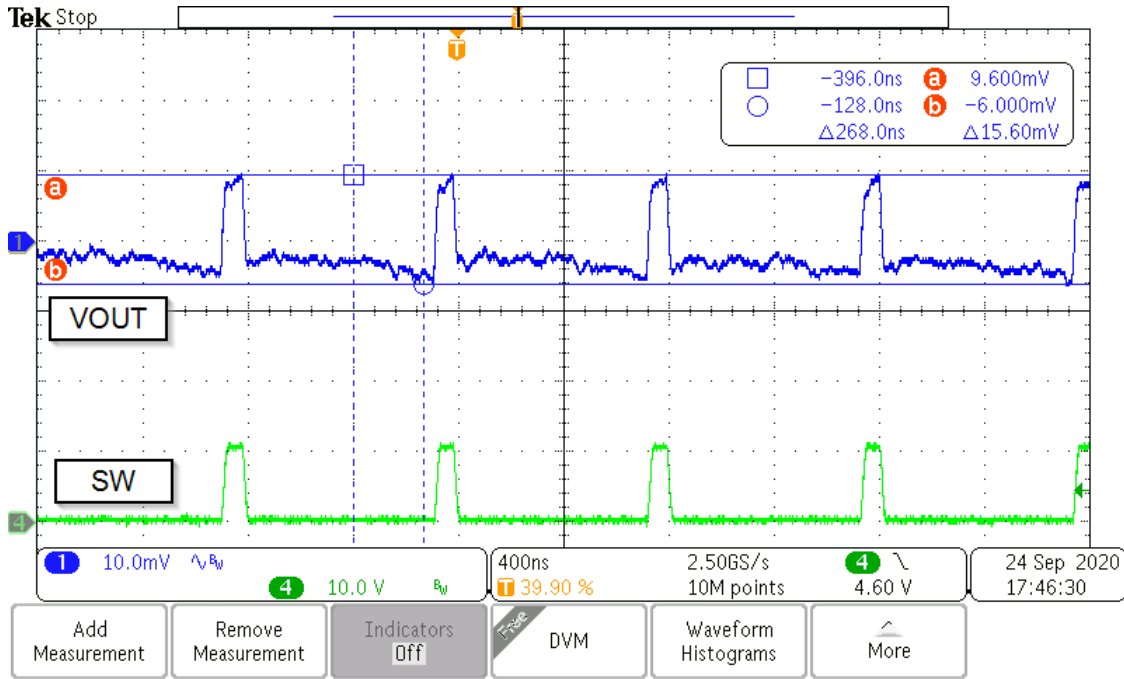

Figure 4-9. Output Voltage Ripple - 12-A load, $\Delta V_{OUT} = 14.4 \text{ mV}$, $f_{sw} = 1200 \text{ kHz}$, FCCM

4.3.11 Start Up

Figure 4-10 shows the V_{OUT} , EN, PGOOD, and SW start up waveforms with a 12-A load. The time between the rising edge of the EN signal and the rising edge of PGOOD is approximately 1.95 ms.

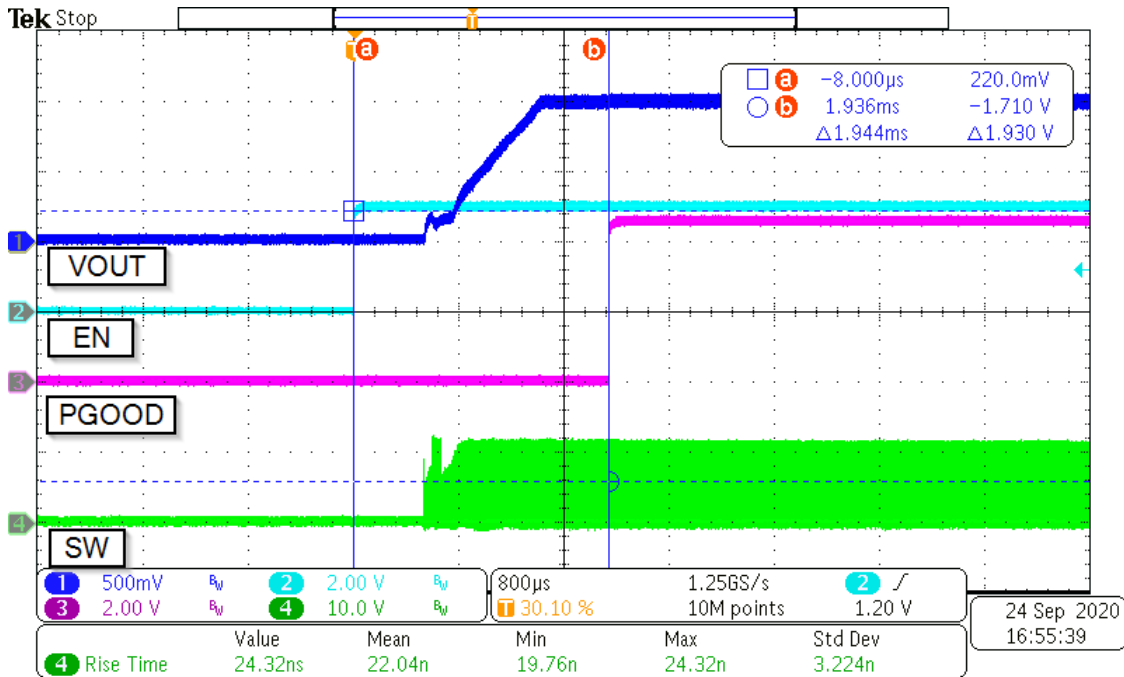

Figure 4-10. Start up - 12-A load, $f_{sw} = 1200 \text{ kHz}$, FCCM

5 TPS542A50EVM-059 PCB Layout

The PCB layout of the TPS542A50EVM-059 is shown in Figure 5-1 through Figure 5-8. The top, internal, and bottom layers are all 2 oz. copper.

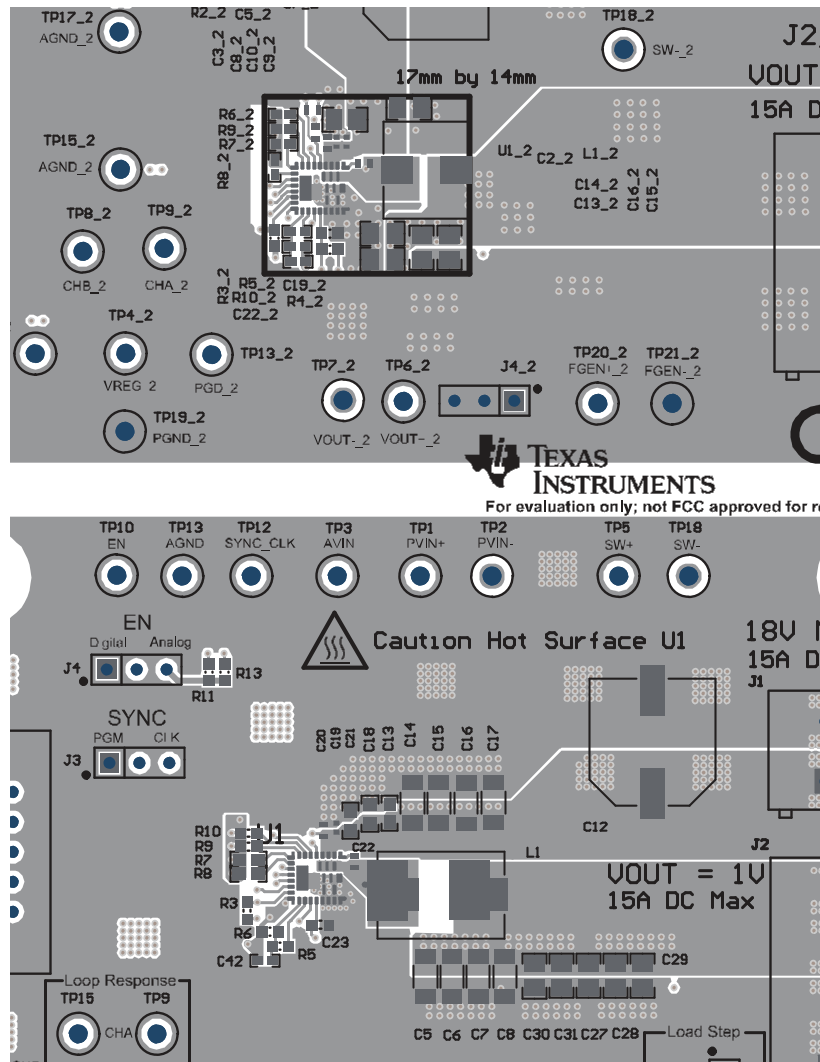

Figure 5-1. Top-Side Composite View

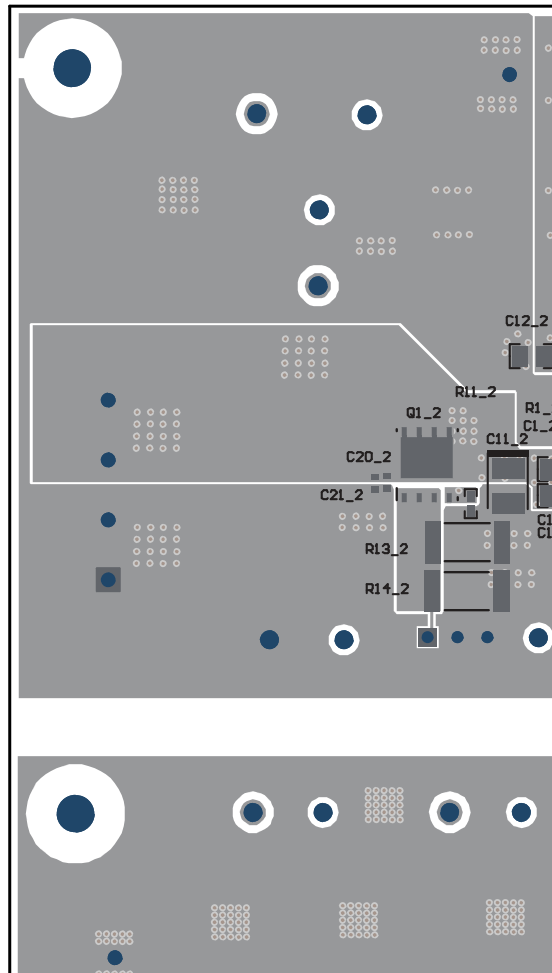

Figure 5-2. Bottom-Side Composite View (Viewed From Bottom)

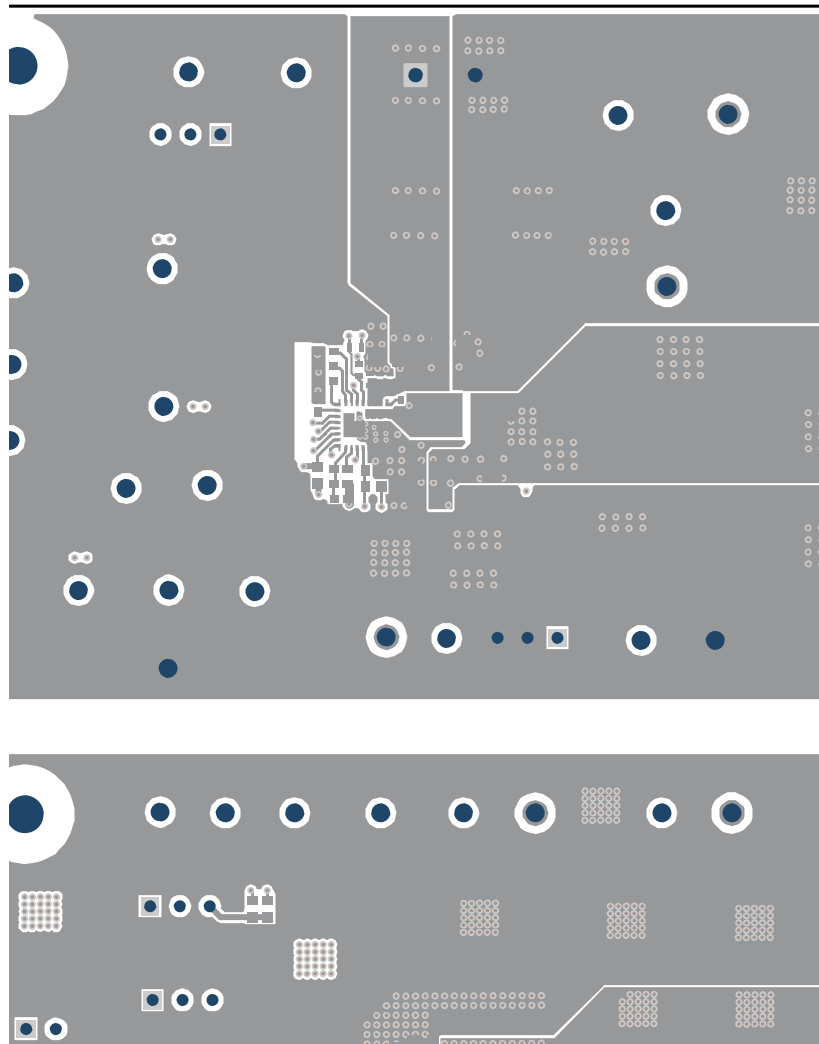

Figure 5-3. Top-Side Layout (Top-Down View)

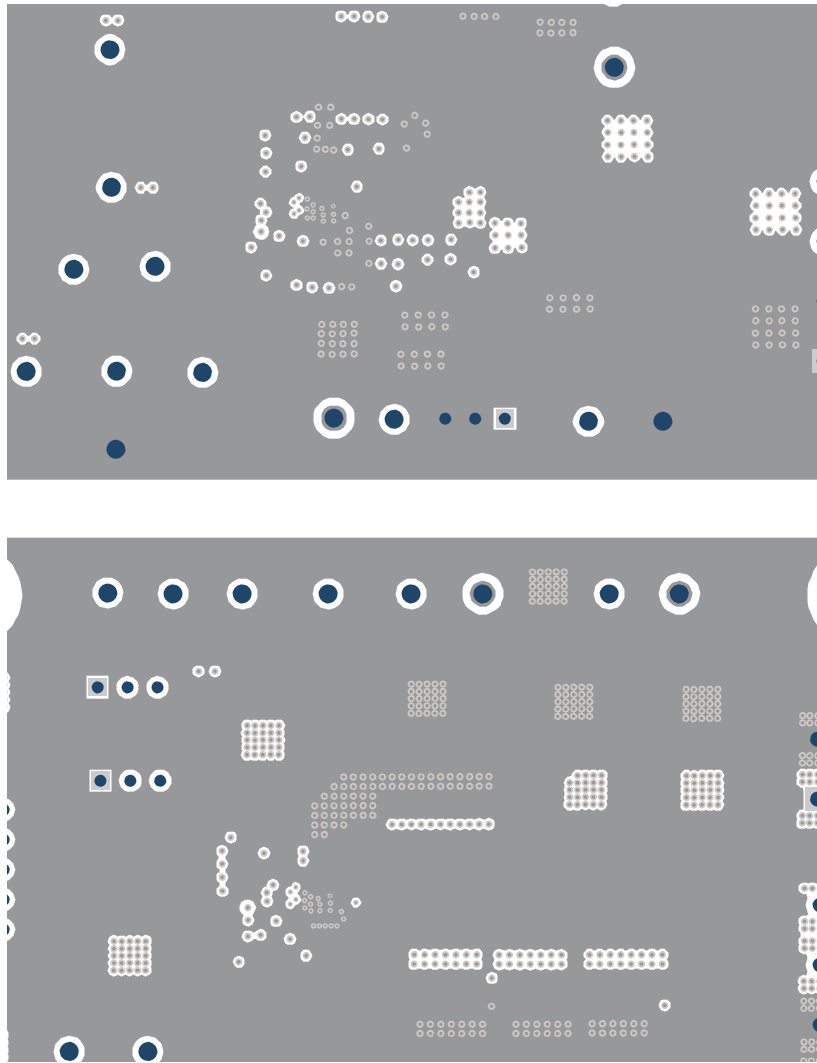

Figure 5-4. Internal Layer-1 Layout (Top-Down View)

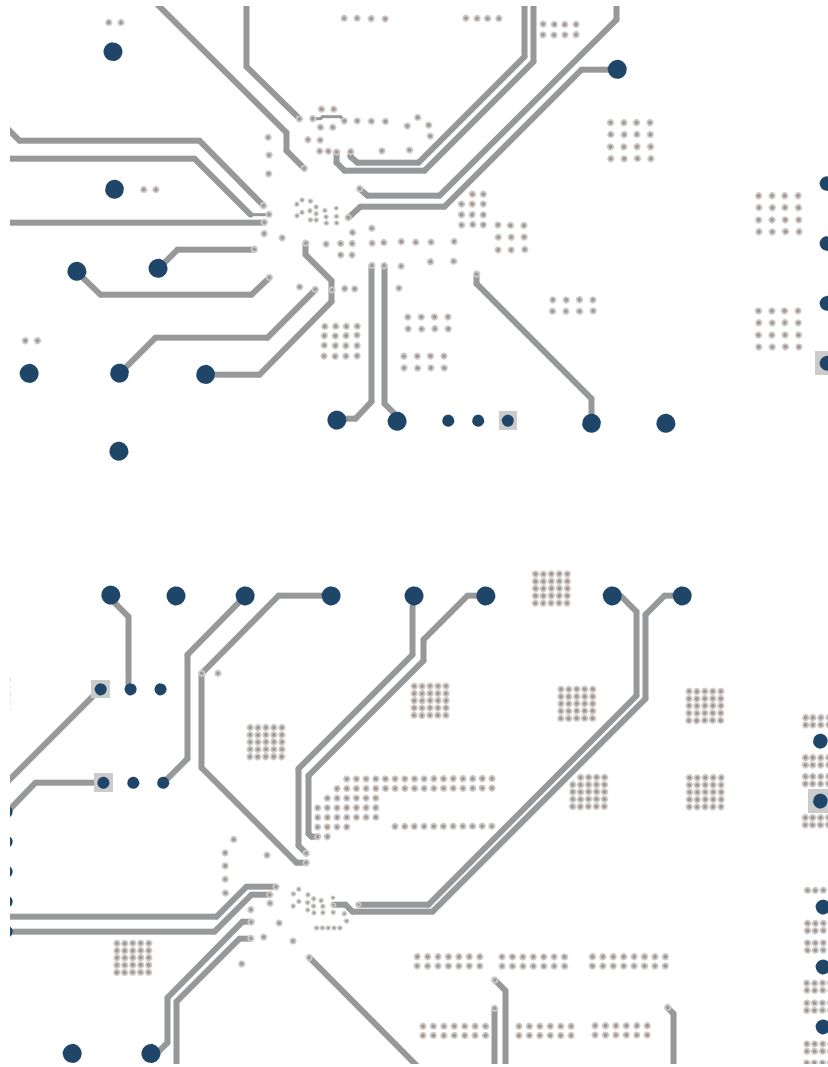

Figure 5-5. Internal Layer-2 Layout (Top-Down View)

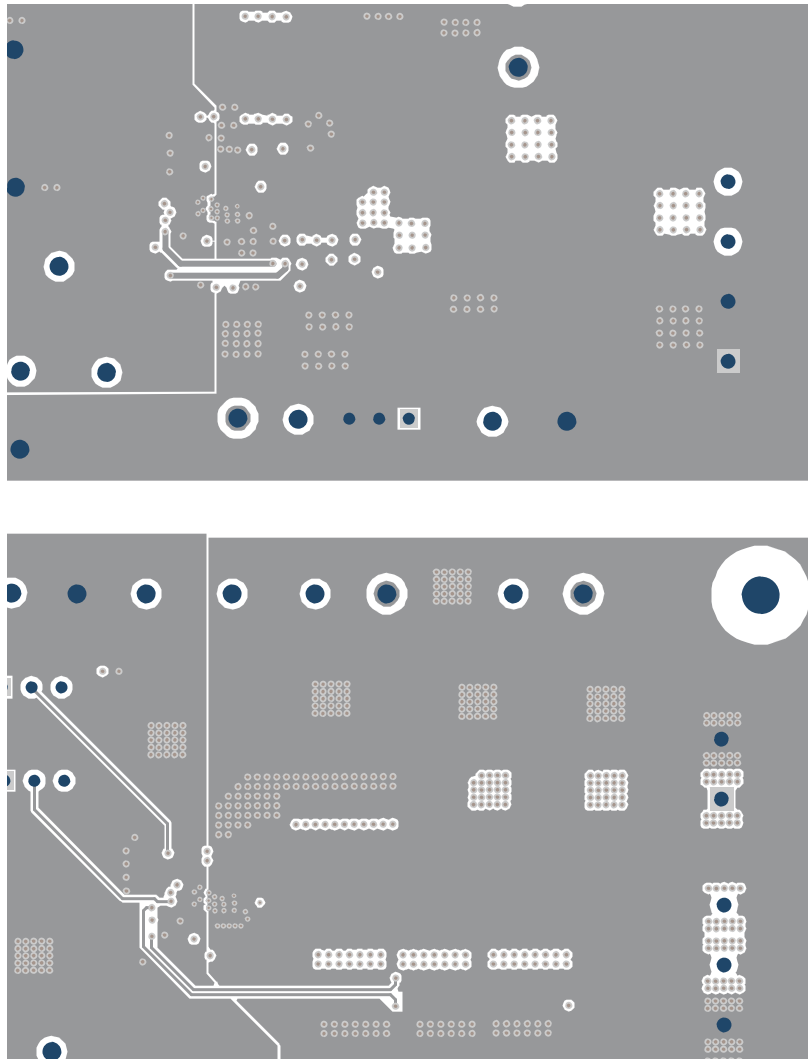

Figure 5-6. Internal Layer-3 Layout (Top-Down View)

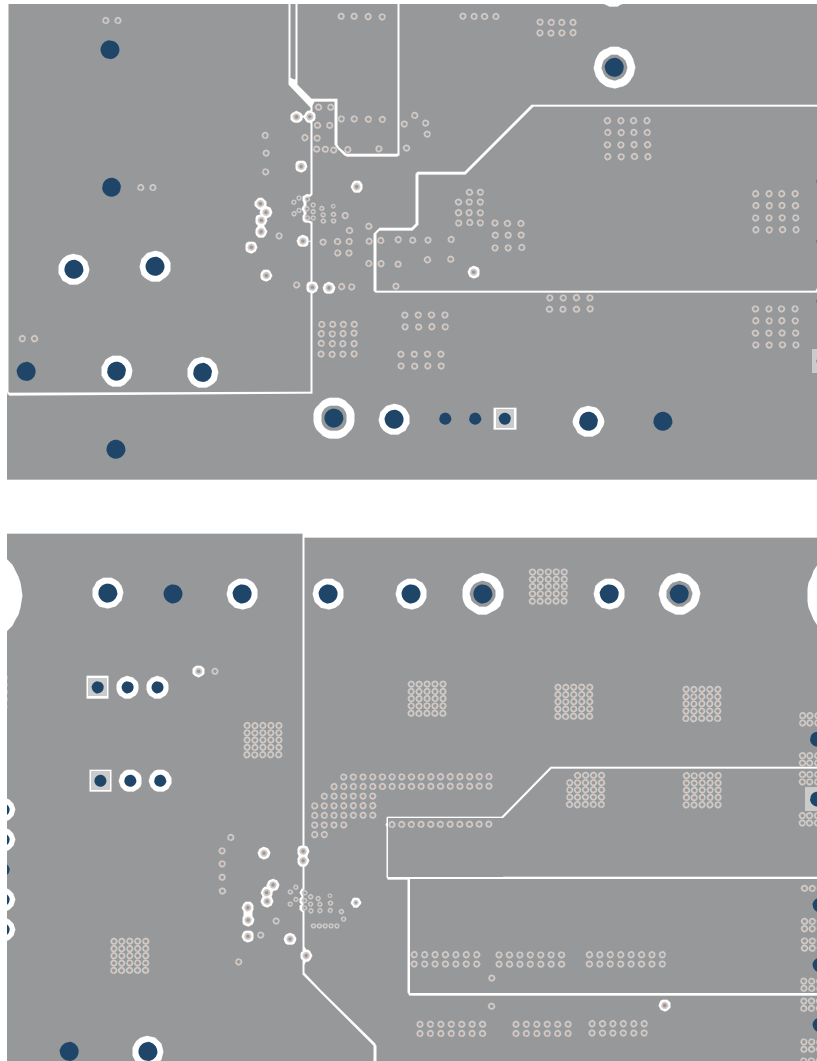

Figure 5-7. Internal Layer-4 Layout (Top-Down View)

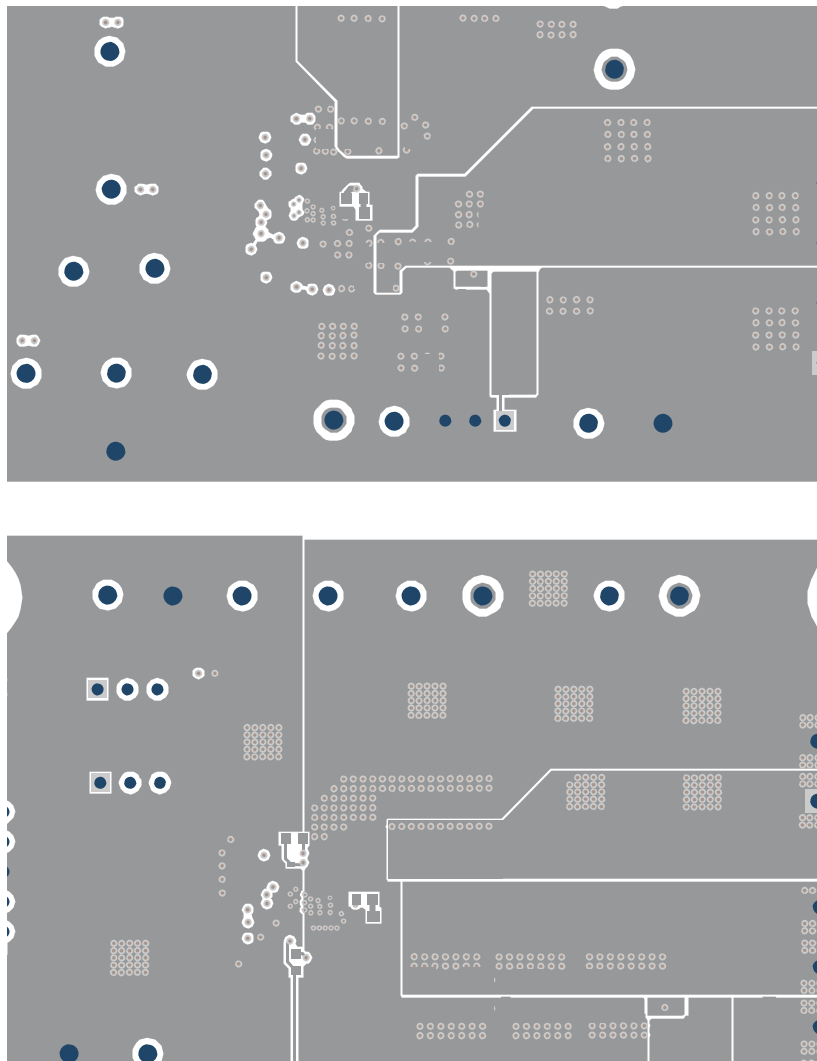

Figure 5-8. Bottom-Side Layout (Top-Down View)

6 List of Materials

The EVM components list, according to the schematic, is shown in [Table 6-1](#).

Table 6-1. TPS542A50EVM-059 List of Materials

Designator	Quantity	Value	Description	Package Reference	Part Number	Manufacturer
!PCB1	1		Printed Circuit Board		BSR059	Any
C1, C11_2	0	DNP, 220uF	CAP, Tantalum Polymer, 220 uF, 6.3 V, +/- 20%, 0.035 ohm, 3.5x1.9x2.8mm SMD	3.5x1.9x2.8mm	6TPE220MAZB	Panasonic
C1_2, C33	0	220pF	CAP, CERM, 220 pF, 50 V, +/- 10%, X7R, 0603	0603	C0603X221K5RACTU	Kemet
C2, C3, C4	3	220uF	CAP, Tantalum Polymer, 220 uF, 6.3 V, +/- 20%, 0.035 ohm, 3.5x1.9x2.8mm SMD	3.5x1.9x2.8mm	6TPE220MAZB	Panasonic
C2_2, C22	2	0.1uF	CAP, CERM, 0.1 uF, 25 V, +/- 10%, X7R, 0402	0402	GRM155R71E104KE14D	MuRata
C3_2, C11	2	0.47uF	CAP, CERM, 0.47 uF, 25 V,+/- 10%, X5R, 0402	0402	GRM155R61E474KE01D	MuRata
C4_2, C12	2	330uF	CAP, AL, 330 uF, 25 V, +/- 20%, 0.15 ohm, SMD	SMT Radial G	EEE-FC1E331P	Panasonic
C5, C6, C7, C8	4	100uF	CAP, CERM, 100 uF, 4 V, +/- 20%, X6T, 1206	1206	GRM31CD80G107ME39L	MuRata
C5_2, C7_2	2	10uF	CAP, CERM, 10 uF, 25 V,+/- 10%, X6S, 0805	0805	GRM21BC81E106KE51L	MuRata
C6_2, C12_2	0	10uF	CAP, CERM, 10 uF, 25 V,+/- 10%, X6S, 0805	0805	GRM21BC81E106KE51L	MuRata
C8_2, C9, C20, C25, C26	5	0.1uF	CAP, CERM, 0.1 uF, 25 V, +/- 20%, X7R, 0402	0402	TMK105B7104MV-FR	Taiyo Yuden
C9_2, C10_2, C19	3		CAP CER 1UF 25V X6S 0402	0402	GRM155C81E105KE11D	Murata
C10	0	0.1uF	CAP, CERM, 0.1 uF, 25 V, +/- 20%, X7R, 0402	0402	TMK105B7104MV-FR	Taiyo Yuden
C13, C18, C21	3	4.7uF	CAP, CERM, 4.7 uF, 25 V, +/- 10%, X6S, 0603	0603	GRM188C81E475KE11D	MuRata
C13_2, C14_2, C15_2, C16_2	4	100uF	CAP, CERM, 100 uF, 4 V,+/- 20%, X6S, 0805	0805	GRM21BC80G107ME15L	MuRata
C14, C15	2	22uF	CAP, CERM, 22 uF, 25 V, +/- 20%, X6S, 1206_190	1206_190	GRM31CC81E226ME11L	MuRata
C16, C17	0	22uF	CAP, CERM, 22 uF, 25 V, +/- 20%, X6S, 1206_190	1206_190	GRM31CC81E226ME11L	MuRata
C17_2, C18_2	0	100uF	CAP, CERM, 100 uF, 4 V,+/- 20%, X6S, 0805	0805	GRM21BC80G107ME15L	MuRata
C19_2, C23	2	4.7uF	CAP, CERM, 4.7 uF, 16 V, +/- 10%, X5R, 0603	0603	GRM188R61C475KAAJ	MuRata
C20_2, C21_2	2	0.01uF	CAP, CERM, 0.01 uF, 50 V, +/- 5%, X7R, 0402	0402	C0402C103J5RACTU	Kemet
C22_2, C42	0	1000pF	CAP, CERM, 1000 pF, 50 V, +/- 10%, X7R, 0402	0402	GRM155R71H102KA01D	MuRata
C27, C28, C29, C31	0	47uF	CAP, CERM, 47 uF, 6.3 V, +/- 20%, X5R, AEC-Q200 Grade 3, 0805	0805	GRT21BR60J476ME13L	MuRata
C30	1	47uF	CAP, CERM, 47 uF, 6.3 V, +/- 20%, X5R, AEC-Q200 Grade 3, 0805	0805	GRT21BR60J476ME13L	MuRata
C35, C36	2	0.01uF	CAP, CERM, 0.01 uF, 50 V, +/- 10%, X7R, AEC-Q200 Grade 1, 0603	0603	GCM188R71H103KA37D	MuRata
C37	1	1uF	CAP, CERM, 1 uF, 16 V, +/- 10%, X7R, 0603	0603	EMK107B7105KA-T	Taiyo Yuden
H1, H2, H3, H4, H9, H11	6		Machine Screw, Round, #4-40 x 1/4, Nylon, Phillips panhead	Screw	NY PMS 440 0025 PH	B&F Fastener Supply
H5, H6, H7, H8, H10, H12	6		Standoff, Hex, 0.5"L #4-40 Nylon	Standoff	1902C	Keystone
J1, J1_2	2		Terminal Block, 5.08 mm, 2x1, Brass, TH	2x1 5.08 mm Terminal Block	ED120/2DS	On-Shore Technology
J2, J2_2	2		Terminal Block, 5.08 mm, 4x1, Brass, TH	4x1 5.08 mm Terminal Block	ED120/4DS	On-Shore Technology
J3, J3_2, J4, J4_2, J5	5		Header, 100mil, 3x1, Tin, TH	Header, 3 PIN, 100mil, Tin	PEC03SAAN	Sullins Connector Solutions
J6	1		Header(Shrouded), 2.54mm, 5x2, Gold, TH	Header, 2.54mm, 5x2, TH	AWHW-10G-0202-T	Assman WSW
L1	1	330nH	Inductor, Shielded Drum Core, Ferrite, 330 nH, 27 A, 0.00037 ohm, SMD	10.1x6.8x7mm	744308033	Würth Elektronik
L1_2	1	220nH	Inductor, Shielded Drum Core, Ferrite, 220 nH, 29 A, 0.00033 ohm, SMD	7.4x7x7.2mm	744307022	Würth Elektronik

Table 6-1. TPS542A50EVM-059 List of Materials (continued)

Designator	Quantity	Value	Description	Package Reference	Part Number	Manufacturer
LBL1	1		Thermal Transfer Printable Labels, 0.650" W x 0.200" H - 10,000 per roll	PCB Label 0.650 x 0.200 inch	THT-14-423-10	Brady
Q1, Q1_2	2	30V	MOSFET, N-CH, 30 V, 65 A, DQJ0008A (VSONP-8)	DQJ0008A	CSD17527Q5A	Texas Instruments
R1, R3, R3_2	3	10.0	RES, 10.0, 1%, 0.1 W, 0603	0603	RC0603FR-0710RL	Yageo America
R1_2, R4	0	1.0	RES, 1.0, 5%, 0.1 W, AEC-Q200 Grade 0, 0603	0603	CRCW06031R00JNEA	Vishay-Dale
R2, R4_2, R16, R17	4	10.0k	RES, 10.0 k, 1%, 0.1 W, 0603	0603	RCG060310K0FKEA	Vishay Draloric
R2_2	1	10.0	RES, 10.0, 1%, 0.063 W, 0402	0402	RK73H1ETTP10R0F	KOA Speer
R5	1	100k	RES, 100 k, 1%, 0.1 W, 0603	0603	RC0603FR-07100KL	Yageo America
R5_2	1	100k	RES, 100 k, 1%, 0.0625 W, 0402	0402	RC0402FR-07100KL	Yageo America
R6	1	20.0k	RES, 20.0 k, 1%, 0.1 W, 0603	0603	RC0603FR-0720KL	Yageo America
R6_2, R7_2, R8_2	2	44.2k	RES, 44.2 k, 1%, 0.063 W, AEC-Q200 Grade 0, 0402	0402	CRCW040244K2FKED	Vishay-Dale
R7, R8	2	61.9k	RES, 61.9 k, 1%, 0.1 W, 0603	0603	RC0603FR-0761K9L	Yageo
R9	1	16.2k	RES, 16.2 k, 1%, 0.1 W, 0603	0603	RC0603FR-0716K2L	Yageo America
R9_2	1	23.7k	RES, 23.7 k, 1%, 0.063 W, AEC-Q200 Grade 0, 0402	0402	CRCW040223K7FKED	Vishay-Dale
R10	1	33.2k	RES, 33.2 k, 1%, 0.1 W, 0603	0603	RC0603FR-0733K2L	Yageo America
R10_2	1	20.0k	RES, 20.0 k, 1%, 0.063 W, AEC-Q200 Grade 0, 0402	0402	CRCW040220K0FKED	Vishay-Dale
R11, R12_2, R13, R15_2	0	10.0k	RES, 10.0 k, 1%, 0.1 W, 0603	0603	RCG060310K0FKEA	Vishay Draloric
R11_2, R12	2	49.9	RES, 49.9, 1%, 0.063 W, AEC-Q200 Grade 0, 0402	0402	CRCW040249R9FKED	Vishay-Dale
R13_2, R14, R14_2, R15	4	0.02	RES, 0.02, 1%, 3 W, 2512	2512	CRA2512-FZ-R020ELF	Bourns
SH-J1, SH-J2, SH-J3, SH-J4, SH-J5	5		Shunt, 100mil, Gold plated, Black	Shunt 2 pos. 100 mil	881545-2	TE Connectivity
TP1, TP1_2, TP3, TP3_2, TP4, TP4_2, TP6, TP6_2, TP19, TP20_2	10		Test Point, Multipurpose, Red, TH	Red Multipurpose Testpoint	5010	Keystone
TP2, TP2_2, TP7, TP7_2, TP13, TP14, TP15, TP15_2, TP16_2, TP17, TP17_2, TP18, TP18_2, TP19_2, TP20, TP21_2	16		Test Point, Multipurpose, Black, TH	Black Multipurpose Testpoint	5011	Keystone
TP5, TP5_2, TP8, TP8_2, TP9, TP9_2, TP10, TP10_2, TP11, TP11_2, TP12, TP12_2, TP13_2, TP14_2	14		Test Point, Multipurpose, White, TH	White Multipurpose Testpoint	5012	Keystone
U1, U1_2	2		4-V to 18-V Input, 15-A, Synchronous Buck Converter with Differential Remote Sense and I2C, RJM0033A (VQFN-HR-33)	RJM0033A	TPS542A50RJM	Texas Instruments

7 Revision History

NOTE: Page numbers for previous revisions may differ from page numbers in the current version.

Changes from Revision * (September 2020) to Revision A (October 2021)	Page
• Updated the numbering format for tables, figures, and cross-references throughout the document.	3
• Updated the user's guide title.....	3

IMPORTANT NOTICE AND DISCLAIMER

TI PROVIDES TECHNICAL AND RELIABILITY DATA (INCLUDING DATA SHEETS), DESIGN RESOURCES (INCLUDING REFERENCE DESIGNS), APPLICATION OR OTHER DESIGN ADVICE, WEB TOOLS, SAFETY INFORMATION, AND OTHER RESOURCES "AS IS" AND WITH ALL FAULTS, AND DISCLAIMS ALL WARRANTIES, EXPRESS AND IMPLIED, INCLUDING WITHOUT LIMITATION ANY IMPLIED WARRANTIES OF MERCHANTABILITY, FITNESS FOR A PARTICULAR PURPOSE OR NON-INFRINGEMENT OF THIRD PARTY INTELLECTUAL PROPERTY RIGHTS.

These resources are intended for skilled developers designing with TI products. You are solely responsible for (1) selecting the appropriate TI products for your application, (2) designing, validating and testing your application, and (3) ensuring your application meets applicable standards, and any other safety, security, regulatory or other requirements.

These resources are subject to change without notice. TI grants you permission to use these resources only for development of an application that uses the TI products described in the resource. Other reproduction and display of these resources is prohibited. No license is granted to any other TI intellectual property right or to any third party intellectual property right. TI disclaims responsibility for, and you will fully indemnify TI and its representatives against, any claims, damages, costs, losses, and liabilities arising out of your use of these resources.

TI's products are provided subject to [TI's Terms of Sale](#) or other applicable terms available either on ti.com or provided in conjunction with such TI products. TI's provision of these resources does not expand or otherwise alter TI's applicable warranties or warranty disclaimers for TI products.

TI objects to and rejects any additional or different terms you may have proposed.

Mailing Address: Texas Instruments, Post Office Box 655303, Dallas, Texas 75265
Copyright © 2022, Texas Instruments Incorporated