

TPS549B22 SWIFT™ Step-Down Converter Evaluation Module User's Guide



ABSTRACT

This user's guide describes the characteristics, operation, and use of the TPS549B22 Evaluation Module (EVM). The user's guide includes test information, descriptions, and results. A complete schematic diagram, printed-circuit board layouts, and bill of materials are also included in this document. Throughout this user's guide, the abbreviations EVM, TPS549B22EVM, and the term evaluation module are synonymous with the TPS549B22EVM-847, unless otherwise noted.

Table of Contents

1 Introduction	3
1.1 Before You Begin.....	3
2 Description	4
2.1 Typical End-User Applications.....	4
2.2 EVM Features.....	4
3 EVM Electrical Performance Specifications	5
4 Schematic	6
5 Test Setup	7
5.1 Test and Configuration Software.....	7
6 Test Equipment	8
7 PWR-847EVM	9
8 List of Test Points, Jumpers, and Switch	11
9 EVM Configuration Using the Fusion GUI	12
10 Test Procedure	13
10.1 Line and Load Regulation Measurement Procedure.....	13
10.2 Efficiency.....	13
10.3 Equipment Shutdown.....	13
11 Performance Data and Typical Characteristic Curves	14
11.1 Efficiency.....	14
11.2 Load Regulation.....	14
11.3 Line Regulation.....	15
11.4 Transient Response.....	18
11.5 Output Ripple.....	18
11.6 Control On.....	19
11.7 Control Off.....	20
11.8 Thermal Image.....	21
12 Fusion GUI	22
13 EVM Assembly Drawing and PCB Layout	33
14 List of Materials	38
15 Revision History	40

List of Figures

Figure 4-1. PWR-847EVM Schematic.....	6
Figure 7-1. PWR-847EVM Overview.....	9
Figure 7-2. Tip and Barrel Measurement.....	9
Figure 7-3. EVM and USB Interface Adapter.....	10
Figure 11-1. Efficiency vs Output Current SKIP Mode.....	14
Figure 11-2. Power Loss vs Output Current SKIP Mode.....	14
Figure 11-3. Line Regulation of 1-V Output.....	15

Figure 11-4. PMBus V_{OUT} Step-Up = 0.6 V to 1.2 V at 0 A.....	15
Figure 11-5. PMBus V_{OUT} Step-Down = 1.2 V to 0.6 V at 0 A.....	16
Figure 11-6. PMBus V_{OUT} Step-Up = 0.6 V to 1.2 V at 25 A.....	16
Figure 11-7. PMBus V_{OUT} Step-Down = 1.2 V to 0.6 V at 25 A.....	17
Figure 11-8. PMBUS Multiple Commands.....	17
Figure 11-9. Transient Response of 1-V Output at 12 V_{IN} , Transient is 0.5 A to 15.5 A, the Step is 15 A at 40 A/ μ s.....	18
Figure 11-10. Output Ripple and SW Node of 1-V Output at 12 V_{IN} , 25-A Output.....	18
Figure 11-11. Output Ripple and SW Node of 1-V Output at 12 V_{IN} , 0-A Output.....	19
Figure 11-12. Start up from Control, 1-V Output at 12 V_{IN} , 0-A Output.....	19
Figure 11-13. 0.5-V Pre-bias start up from Control, 1-V Output at 12 V_{IN} , 10-A Output.....	20
Figure 11-14. Start-Up and Shutdown, 1-V Output at 12 V_{IN} , 0.5-A Output.....	20
Figure 11-15. Thermal Image at 1-V Output at 12 V_{IN} , 25-A Output, 650 kHz at 25°C Ambient.....	21
Figure 12-1. First Window at Fusion Launch.....	22
Figure 12-2. Scan Finds Device Successfully.....	22
Figure 12-3. Software Launch Continued.....	22
Figure 12-4. Software Launch Continued.....	22
Figure 12-5. First Screen After Successful Launch Configure: Limits and On/Off.....	23
Figure 12-6. Configure: Frequency- FS Configuration Pop-up.....	24
Figure 12-7. Configure: Frequency- FS Config Pop-Up with Change.....	25
Figure 12-8. Configure: <i>Store Config to NVM</i>	26
Figure 12-9. Change View Screen to Monitor Screen.....	27
Figure 12-10. System Dashboard.....	28
Figure 12-11. Status Screen.....	29
Figure 12-12. Store Configuration To Memory.....	30
Figure 12-13. PMBus Logging.....	31
Figure 12-14. PMBus Log Details.....	32
Figure 13-1. PWR-847EVM Top Layer Assembly Drawing (Top View).....	33
Figure 13-2. PWR-847EVM Top Solder Mask (Top View).....	33
Figure 13-3. PWR-847EVM Top Layer (Top View).....	34
Figure 13-4. PWR-847EVM Inner Layer 1 (Top View).....	34
Figure 13-5. PWR-847EVM Inner Layer 2 (Top View).....	35
Figure 13-6. PWR-847EVM Inner Layer 3 (Top View).....	35
Figure 13-7. PWR-847EVM Inner Layer 4 (Top View).....	36
Figure 13-8. PWR-847EVM Bottom Layer (Top View).....	36
Figure 13-9. PWR-847EVM Bottom Solder Mask (Top View).....	37
Figure 13-10. PWR-847EVM Bottom Overlay Layer (Top View).....	37

List of Tables

Table 3-1. PWR-847EVM Electrical Performance Specifications.....	5
Table 8-1. Test Point Functions.....	11
Table 9-1. Key Factory Configuration Parameters.....	12
Table 10-1. List of Test Points for Line and Load Measurements.....	13
Table 10-2. List of Test Points for Efficiency Measurements.....	13
Table 14-1. PWR847 List of Materials.....	38

Trademarks

PMBus™ is a trademark of SMIF, Inc..

All trademarks are the property of their respective owners.

1 Introduction

The PWR847EVM evaluation module uses the TPS549B22 device. The TPS549B22 is a highly integrated synchronous buck converter that is designed for up to 25-A current output.

1.1 Before You Begin

The following warnings and cautions are noted for the safety of anyone using or working close to the TPS549B22EVM-847. Observe all safety precautions.



Warning

The TPS549B22EVM-847 circuit module may become hot during operation due to dissipation of heat. Avoid contact with the board. Follow all applicable safety procedures applicable to your laboratory.



Caution

Do not leave the EVM powered when unattended.

WARNING

The circuit module has signal traces, components, and component leads on the bottom of the board. This may result in exposed voltages, hot surfaces or sharp edges. Do not reach under the board during operation.

CAUTION

The circuit module may be damaged by over temperature. To avoid damage, monitor the temperature during evaluation and provide cooling, as needed, for your system environment.

CAUTION

Some power supplies can be damaged by application of external voltages. If using more than 1 power supply, check your equipment requirements and use blocking diodes or other isolation techniques, as needed, to prevent damage to your equipment.

CAUTION

The communication interface is not isolated on the EVM. Be sure no ground potential exists between the computer and the EVM. Also be aware that the computer is referenced to the Battery- potential of the EVM.

2 Description

The PWR-847EVM is designed as a single output DC-DC converter that demonstrates the TPS549B22 in a typical low-voltage application while providing a number of test points to evaluate the performance. It uses a nominal 12-V input bus to produce a regulated 1-V output at up to 25-A load current.

2.1 Typical End-User Applications

- Enterprise Storage, SSD, NAS
- Wireless and Wired Communication Infrastructure
- Industrial PCs, Automation, ATE, PLC, Video Surveillance
- Enterprise Server, Switches, Routers
- ASIC, SoC, FPGA, DSP Core and I/O Rails

2.2 EVM Features

- Regulated 1-V output up to 25-A, steady-state output current
- Convenient test points for probing critical waveforms
- PMBus™ connector for easy connection with the TI USB adapter

3 EVM Electrical Performance Specifications

Table 3-1 lists the PWR-847EVM electrical performance specifications.

Table 3-1. PWR-847EVM Electrical Performance Specifications

Parameter	Test Conditions	Min	Typ	Max	Units
Input Characteristics					
Voltage range	V_{IN} tied to VDD	5	12	14	V
Maximum input current	$V_{IN} = 12\text{ V}$, $I_O = 25\text{ A}$			12	A
No load input current	$V_{IN} = 12\text{ V}$, $I_O = 0\text{ A}$		60		mA
Output Characteristics					
V_{OUT} Output voltage	Output current = 10 A		1		V
I_{OUT} Output load current	$I_{OUT(min)}$ to $I_{OUT(max)}$	0		25	A
Output voltage regulation	Line regulation: input voltage = 5 V to 14 V		0.5%		
	Load regulation: output current = 0 A to $I_{OUT(max)}$		0.5%		
V_{OUT} Output voltage ripple	$V_{IN} = 12\text{ V}$, $I_{OUT} = 25\text{ A}$		10		mV _{PP}
V_{OUT} Output overcurrent			32		A
Systems Characteristics					
Switching frequency	F_{SW}		650		kHz
V_{OUT} Peak efficiency	$V_{IN} = 12\text{ V}$, $I_O = 12\text{ A}$, $F_{SW} = 650\text{ kHz}$		90%		
Operating temperature	T_{oper}	0		85	°C

4 Schematic

Figure 4-1 illustrates the PWR-847EVM schematic.

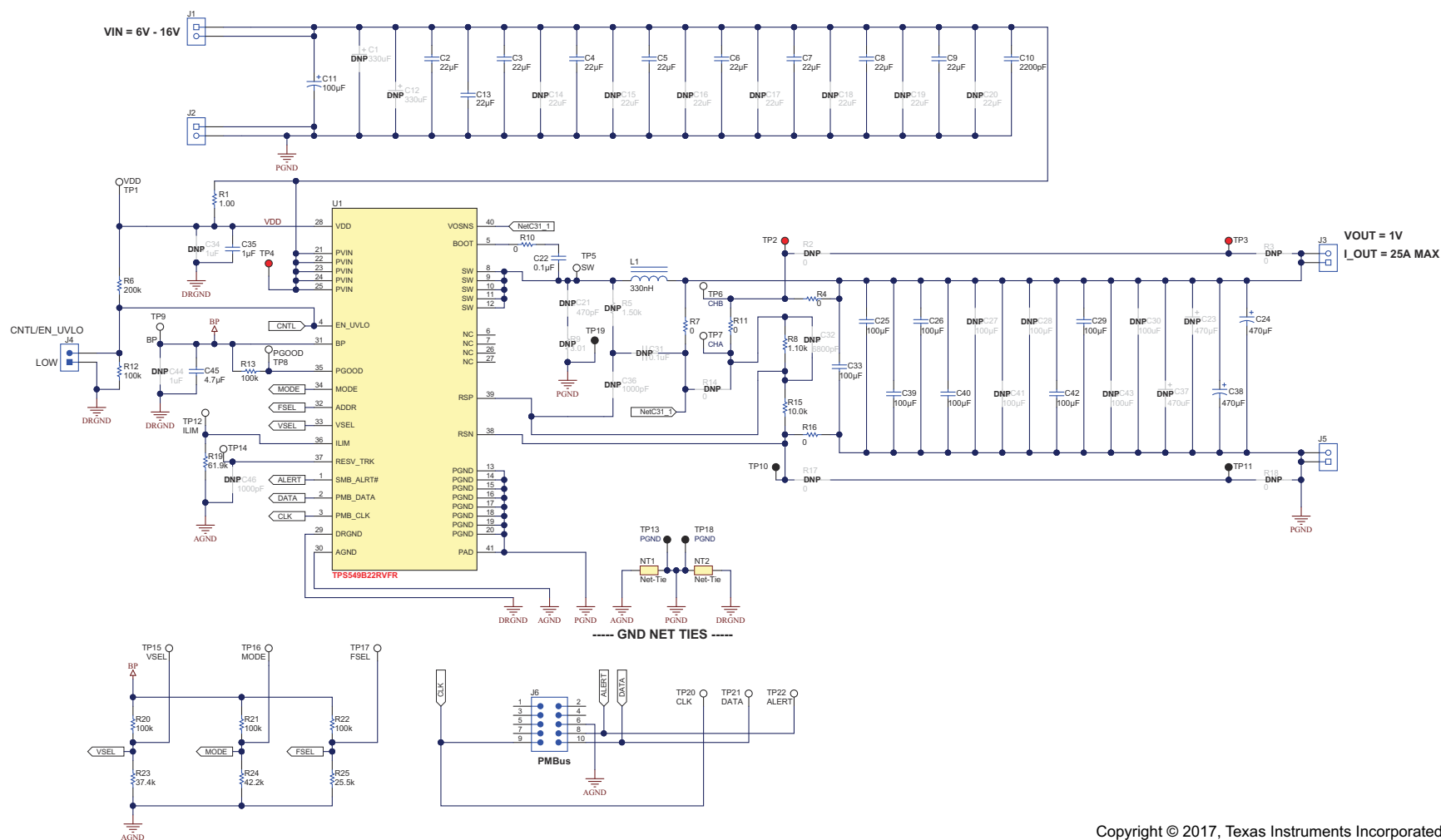

Copyright © 2017, Texas Instruments Incorporated

Figure 4-1. PWR-847EVM Schematic

5 Test Setup

5.1 Test and Configuration Software

To change any of the default configuration parameters on the EVM, it is necessary to obtain the TI Fusion Digital Power Designer software. This can be downloaded from the TI website.

5.1.1 Description

The Fusion Digital Power Designer is the graphical user interface (GUI) used to configure and monitor the Texas Instruments TPS549B22 power converter installed on this evaluation module. The application uses the PMBus protocol to communicate with the controller over serial bus by way of a TI USB adapter. This adapter can be purchased at <http://www.ti.com/tool/usb-to-gpio>.

Note

The TI USB adapter must be purchased separately. It is not included with this EVM kit.

5.1.2 Features

Some of the tasks performed with the GUI include:

- Turn on or off the power supply output, either through the hardware control line or the PMBus operation command.
- Monitor status registers. Items such as input voltage, output voltage, output current, temperature, and warnings and faults are continuously monitored and displayed by the GUI.
- Configure common operating characteristics such as VOUT, UVLO, soft-start time, warning and fault thresholds, fault response, and ON/OFF.

This software is available for download at http://www.ti.com/tool/fusion_digital_power_designer.

6 Test Equipment

Voltage Source: The input voltage source V_{IN} must be a 0-V to 18-V variable DC source capable of supplying at least 12 A_{DC}.

Multimeters: It is recommended to use two separate multimeters [Figure 7-1](#). One meter is used to measure V_{IN} and one to measure V_{OUT} .

Output Load: A variable electronic load is recommended for testing [Figure 7-1](#). It must be capable of 25 A at voltages as low as 0.6 V.

Oscilloscope: An oscilloscope is recommended for measuring output noise and ripple. Output ripple must be measured using a tip-and-barrel method or better as shown in [Figure 7-2](#). The scope must be adjusted to 20-MHz bandwidth, AC coupling at 50 mV/division, and must be set to 1- μ s/division.

Fan: During prolonged operation at high loads, it may be necessary to provide forced air cooling with a small fan aimed at the EVM. Temperature of the devices on the EVM must be maintained below 105°C.

USB-to-GPIO Interface Adapter: A communications adapter is required between the EVM and the host computer. This EVM was designed to use TI's USB-to-GPIO adapter. Purchase this adapter at <http://www.ti.com/tool/usb-to-gpio>.

Recommended Wire Gauge: The voltage drop in the load wires must be kept as low as possible in order to keep the working voltage at the load within its operating range. Use the AWG 14 wire (2 wires parallel for VOUT positive and 2 wires parallel for the VOUT negative) of no more than 1.98 feet between the EVM and the load. This recommended wire gauge and length should achieve a voltage drop of no more than 0.2 V at the maximum 25-A load.

7 PWR-847EVM

Figure 7-1 and Figure 7-2 illustrate the PWR-847EVM overview, tip and barrel measurement.

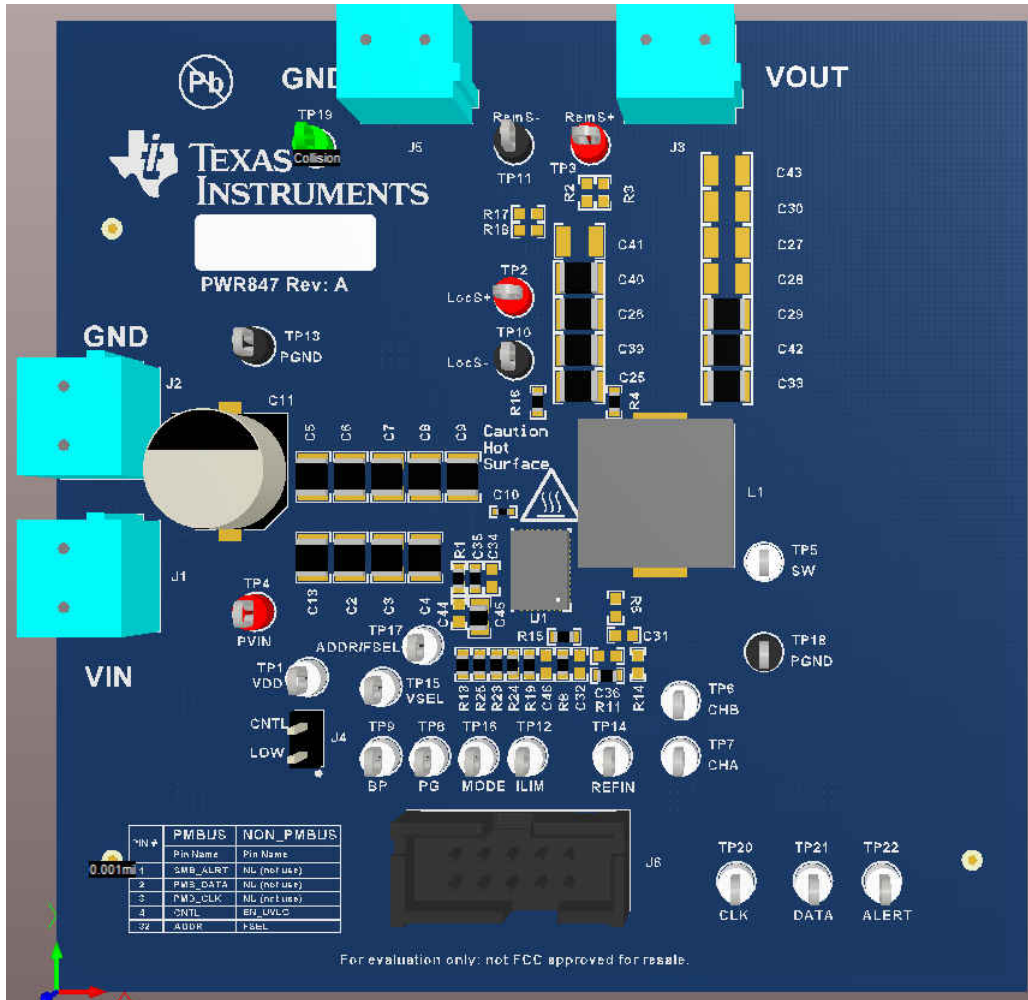

Figure 7-1. PWR-847EVM Overview

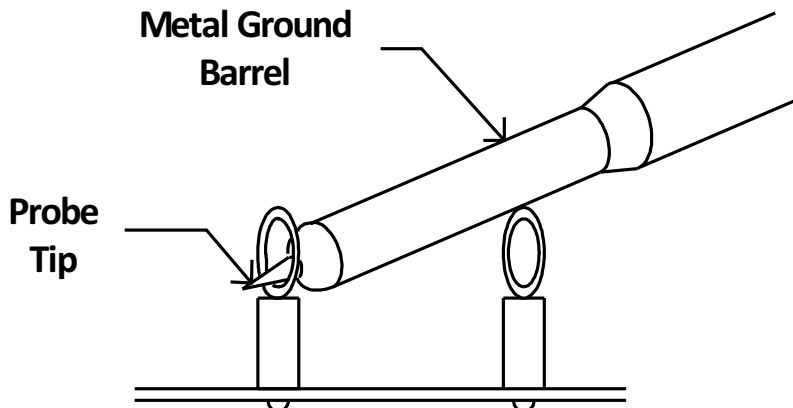

Figure 7-2. Tip and Barrel Measurement

Figure 7-3 illustrates the EVM and USB interface adapter.

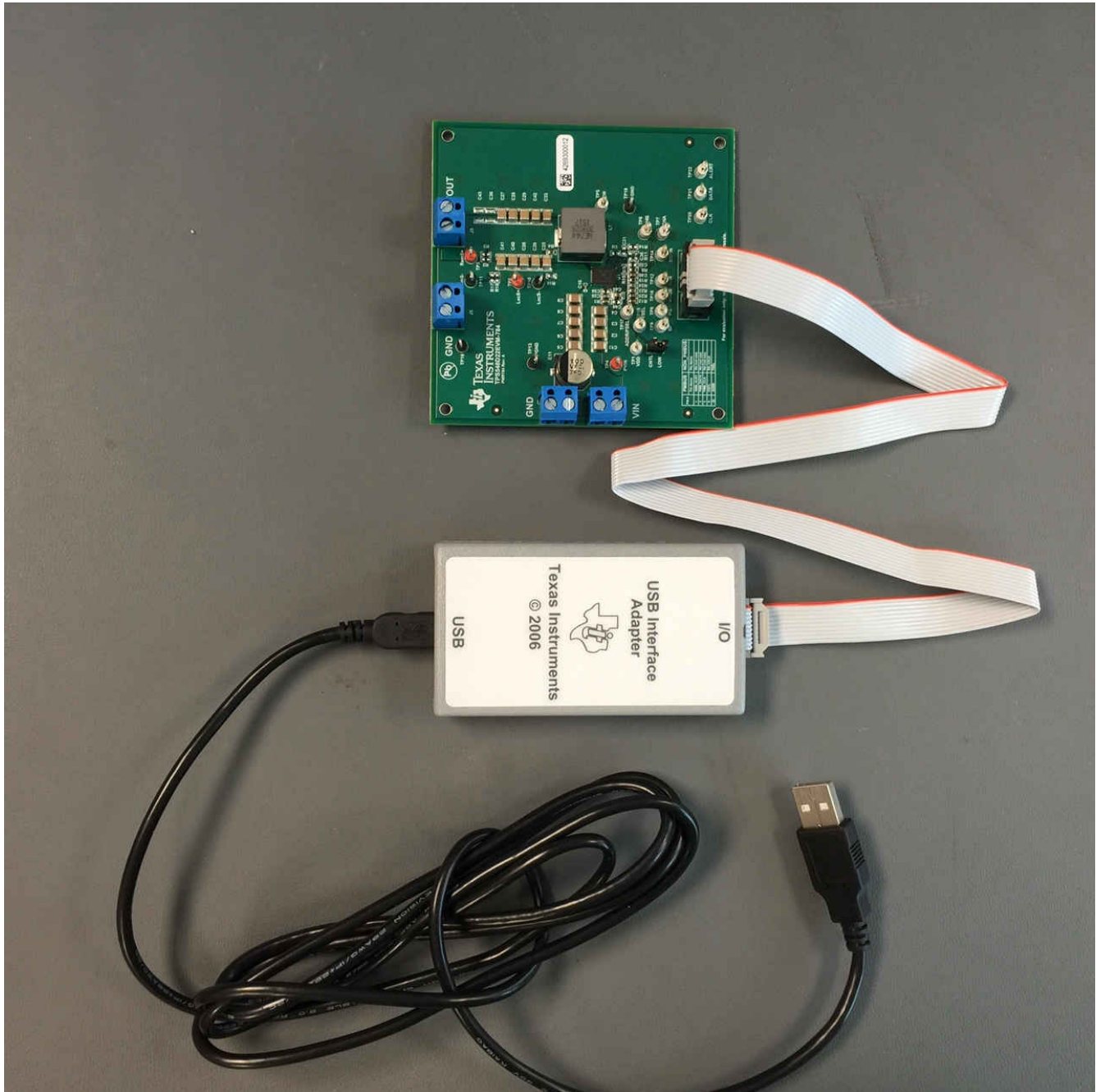

Figure 7-3. EVM and USB Interface Adapter

8 List of Test Points, Jumpers, and Switch

Table 8-1 lists the test points and their descriptions.

Table 8-1. Test Point Functions

Item	Type	Name	Description
TP5	T-H loop	SW	Power supply Switch node
TP7	T-H loop	CH-A	Measure loop stability
TP6	T-H loop	CH-B	Measure loop stability
TP2	T-H loop	LocS+	Sense VOUT + locally across C25. Use for efficiency and ripple measurements
TP10	T-H loop	LocS-	Sense VOUT- locally across C25. Use for efficiency and ripple measurements
TP3	T-H loop	RemS+	Remote sense +
TP11	T-H loop	RemS-	Remote sense –
TP4	T-H loop	PVIN	Sense VIN + across C10
TP13	T-H loop	PGND	Sense VIN – across C10
TP1	T-H loop	VDD	Supplies the internal circuitry
TP17	T-H loop	ADDR	Monitor the ADDR external resistor divider ratio during initial power up.
TP15	T-H loop	VSEL	Monitor the VSEL external resistor divider ratio during initial power up.
TP9	T-H loop	BP	LDO output
TP8	T-H loop	PG	Power good
TP16	T-H loop	MODE	Monitor the MODE external resistor divider ratio during initial power up.
TP12	T-H loop	ILIM	Program over-current limit.
TP14	T-H loop	RESV_TRK	Do not connect.
TP19	T-H loop	PGND	Common GND
TP18	T-H loop	PGND	Common GND
TP20	T-H loop	PMB_CLK	Clock input for the PMBus interface.
TP21	T-H loop	PMB_DATA	Data I/O for the PMBus interface.
TP22	T-H loop	SMB_ALERT#	Alert output for the PMBus interface.
JP4	2-pin jumper	CNTL	Shunts control pin to GND

9 EVM Configuration Using the Fusion GUI

The TPS549B22 installed on this EVM leave the factory pre-configured. See [Table 9-1](#) for a short list of key factory configuration parameters as obtained from the configuration file.

Table 9-1. Key Factory Configuration Parameters

Cmd ID With Phase	Cmd Code Hex	Encoded Hex [HiByte LoByte]	Comments
CAPABILITY	0x19	0xD0	Max Bus: 1000 kHz; PEC: Yes; SMBALERT#: Yes
MFR_00	0xD0	0x00	0
MFR_01 (PGOOD_DLY)	0xD1	0x12	PGD:1024?s [010b], POD:1024?s [010b]
MFR_02	0xD2	0x13	CM: True, HICLOFF: True, SST: 0x00, FORCESKIPSS: True, SEQ: False, TRK: False
MFR_03	0xD3	0x93	FS:650 kHz [011b], RCSP:R ? 1 [01b], DCAP3:True
MFR_04	0xD4	0x80	DCAP3_Offset:0mV [00b], DCAP3_Offset_Sel:True
MFR_06	0xD6	0x05	VDDUVLO:4.25V [101b]
MFR_07	0xD7	0x8F	VTRKIN:1.25V [1111b], TRKOPTION:False, SPARE:False, VPBAD:True
MFR_33	0xF1	0x00	0
MFR_42	0xFA	0x00	0
MFR_44	0xFC	0x0201	ID: 0x020 (TPS549B22), Revision: 0x8
ON_OFF_CONFIG	0x02	0x17	Mode: CONTROL Pin Only; Control: Active High, Turn off Immediately
OPERATION	0x01	0x00	Operation is not used to enable regulatio; Unit: ImmediateOff; Margin: None
STATUS_BYTE	0x78	0x00	Status: Output Off, Vout OV Fault, IOUT OC Fault, Vin UV Fault, Temperature, CML
STATUS_CML	0x7E	0x00	Status: Invalid Command, Invalid Data, PEC Fault, Other Comms Fault
STATUS_IOUT	0x7B	0x00	Status: Iout OC Fault, Iout OC Fault with LV Shutdown, Iout UC Fault
STATUS_VOUT	0x7A	0x00	Status: Vout OV Fault, OV Warning, UV Fault, UV Warning
VOUT_COMMAND	0x21	0x01CD	VOUT_COMMAND=0.900 V
VOUT_MARGIN_HIGH	0x25	0x0266	VOUT_MARGIN_HIGH=1.199 V
VOUT_MARGIN_LOW	0x26	0x0266	VOUT_MARGIN_LOW=1.199 V
WRITE_PROTECT	0x10	0x00	Enable Writes To All Commands

If it is desired to configure the EVM to settings other than the factory settings shown in [Table 9-1](#), the TI Fusion Digital Power Designer software can be used for reconfiguration. It is necessary to have input voltage applied to the EVM prior to launching the software so that the TPS549B22 installed is active and able to respond to the GUI and the GUI can recognize the device.

10 Test Procedure

10.1 Line and Load Regulation Measurement Procedure

Use the following procedures for line and load regulation measurement.

1. Connect VOUT to J3 and VOUT_GND to J5 [Figure 7-1](#).
2. Ensure that the electronic load is set to draw 0 A_{DC}.
3. Connect VIN to J1 and VIN_GND to J2 [Figure 7-1](#).
4. Connect the USB interface adapter as shown in [Figure 7-3](#).
5. Increase V_{IN} from 0 V to 12 V using the digital multimeter to measure input voltage.
6. Launch the Fusion GUI software. See the screen shots in [Section 12](#) for more information.
7. Configure the EVM operating parameters as desired.
8. Use the other digital multimeter or the oscilloscope to measure output voltage V_{OUT} at TP2 and TP10 as you vary the external voltage source.

Table 10-1. List of Test Points for Line and Load Measurements

Test Point	Node Name	Description
TP2	LocS+	Sense VOUT + locally across C5. Use for efficiency and ripple measurements
TP10	LocS-	Sense VOUT - locally across C5. Use for efficiency and ripple measurements
TP4	PVIN	Sense VIN + across C10
TP13	PGND	Sense VIN - across C10

9. Vary the load from 0 A_{DC} to maximum rated output 25 A_{DC}. V_{OUT} must remain in regulation as defined in [Table 3-1](#).
10. Vary V_{IN} from 5 V to 14 V. V_{OUT} must remain in regulation as defined in [Table 3-1](#).
11. Decrease the load to 0 A.
12. Decrease V_{IN} to 0 V or turn off the supply.

10.2 Efficiency

To measure the efficiency of the power train on the EVM, it is important to measure the voltages at the correct location. This is necessary because otherwise the measurements will include losses in efficiency that are not related to the power train itself. Losses incurred by the voltage drop in the copper traces and in the input and output connectors are not related to the efficiency of the power train, and they must not be included in efficiency measurements.

Table 10-2. List of Test Points for Efficiency Measurements

Test Point	Node Name	Description
TP2	LocS+	Sense VOUT + locally across C25. Use for efficiency and ripple measurements
TP10	LocS-	Sense VOUT - locally across C25. Use for efficiency and ripple measurements
TP4	PVIN	Sense VIN + across C10
TP13	PGND	Sense VIN - across C10

Input current can be measured at any point in the input wires, and output current can be measured anywhere in the output wires of the output being measured. Using these measurement points result in efficiency measurements that do not include losses due to the connectors and PCB traces.

10.3 Equipment Shutdown

1. Reduce the load current to 0 A.
2. Reduce input voltage to 0 V.
3. Shut down the external fan if in use.
4. Shut down equipment.

11 Performance Data and Typical Characteristic Curves

Figure 11-1 through Figure 11-14 present typical performance curves for the PWR-847EVM.

11.1 Efficiency

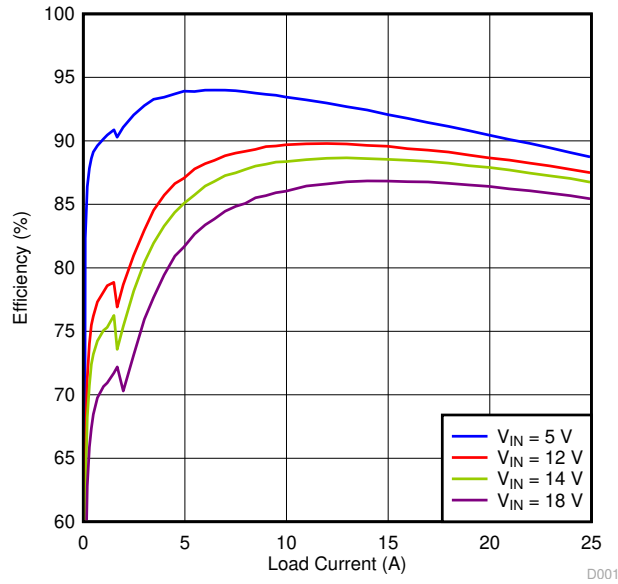

Figure 11-1. Efficiency vs Output Current SKIP Mode

11.2 Load Regulation

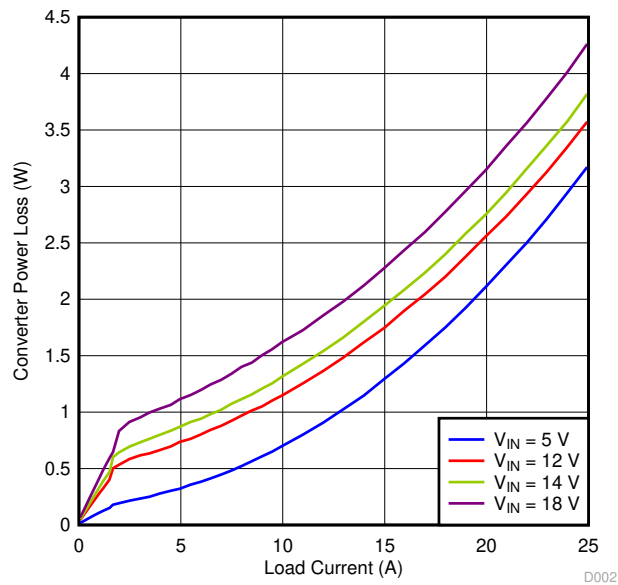

Figure 11-2. Power Loss vs Output Current SKIP Mode

11.3 Line Regulation

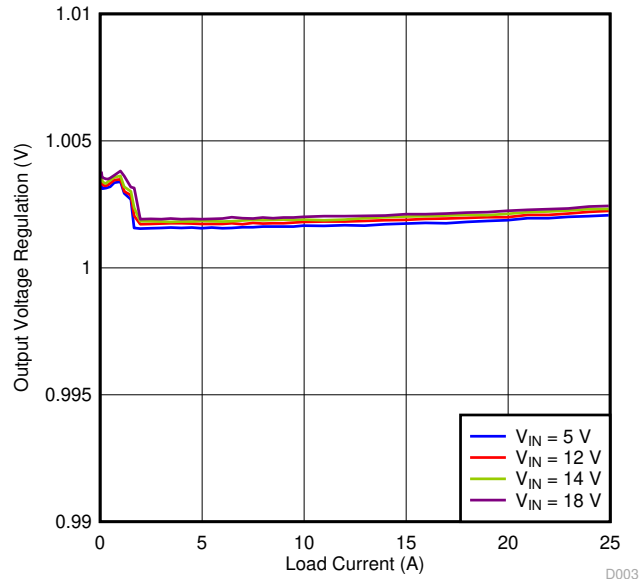

Figure 11-3. Line Regulation of 1-V Output



Figure 11-4. PMBus V_{OUT} Step-Up = 0.6 V to 1.2 V at 0 A



Figure 11-5. PMBus V_{OUT} Step-Down = 1.2 V to 0.6 V at 0 A

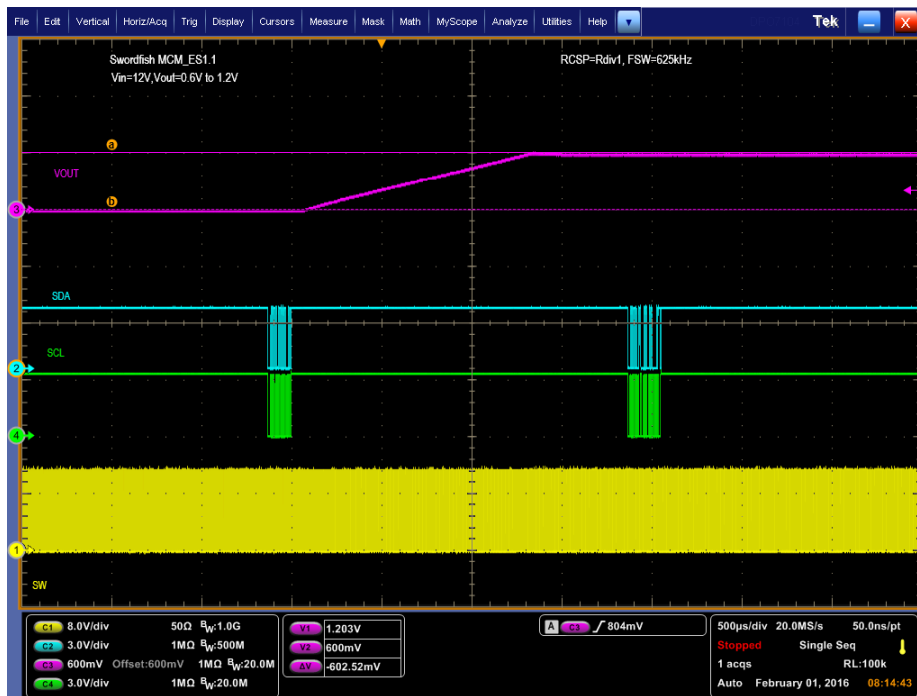

Figure 11-6. PMBus V_{OUT} Step-Up = 0.6 V to 1.2 V at 25 A



Figure 11-7. PMBus V_{OUT} Step-Down = 1.2 V to 0.6 V at 25 A

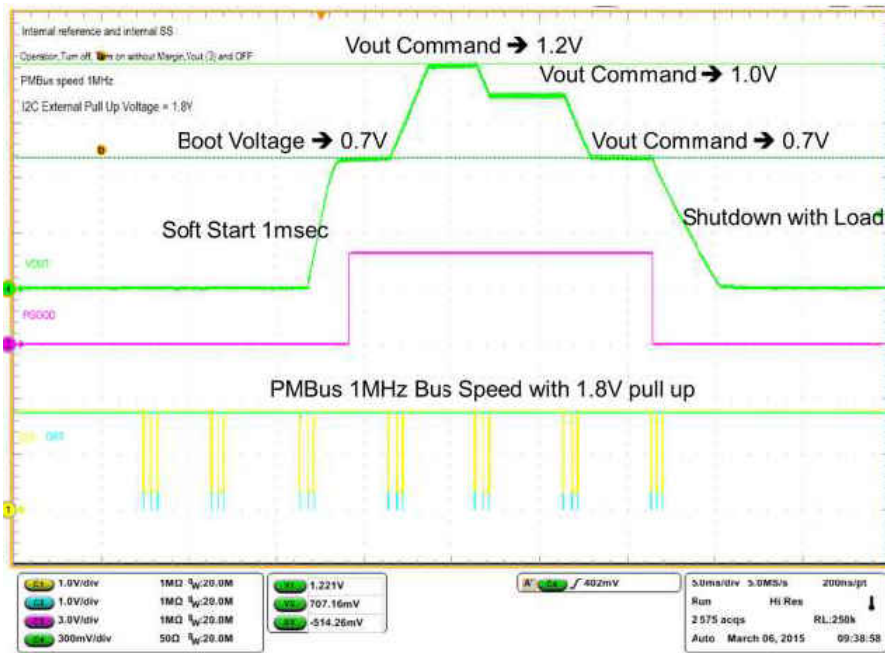

Figure 11-8. PMBUS Multiple Commands

11.4 Transient Response



Figure 11-9. Transient Response of 1-V Output at 12 V_{IN}, Transient is 0.5 A to 15.5 A, the Step is 15 A at 40 A/ μ s

11.5 Output Ripple



Figure 11-10. Output Ripple and SW Node of 1-V Output at 12 V_{IN}, 25-A Output

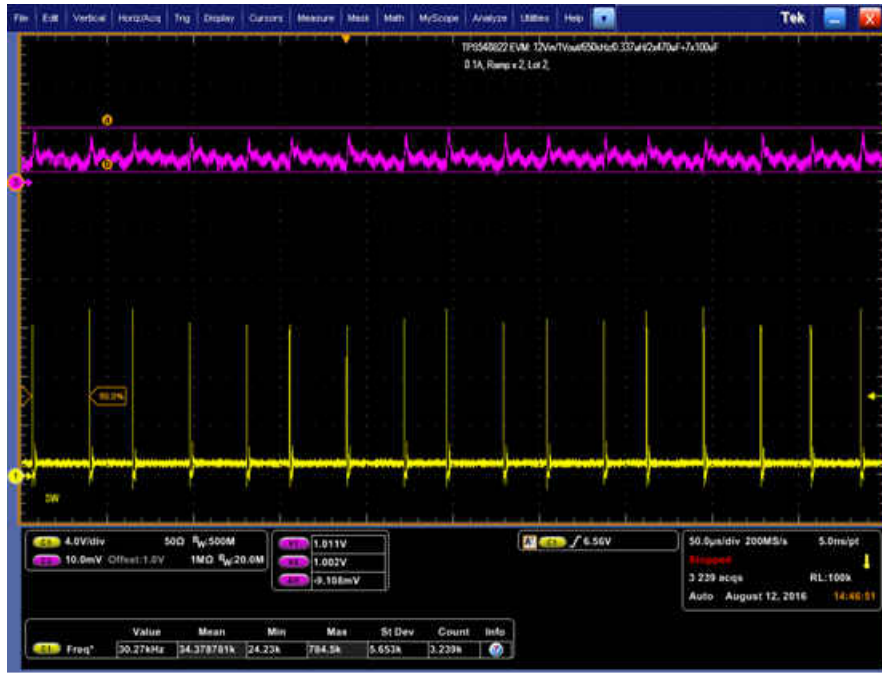

Figure 11-11. Output Ripple and SW Node of 1-V Output at 12 V_{IN}, 0-A Output

11.6 Control On

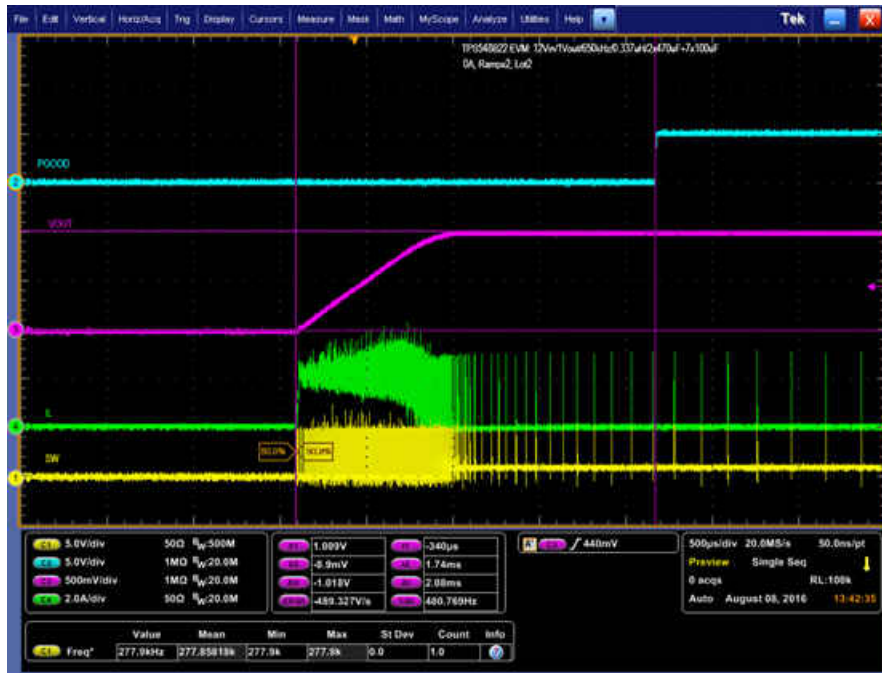

Figure 11-12. Start up from Control, 1-V Output at 12 V_{IN}, 0-A Output

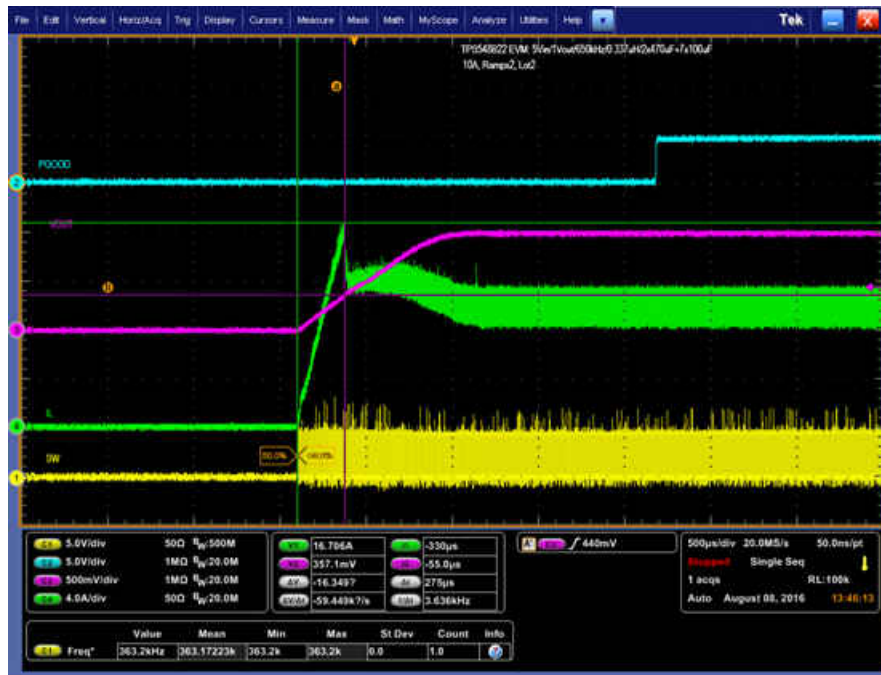

Figure 11-13. 0.5-V Pre-bias start up from Control, 1-V Output at 12 V_{IN}, 10-A Output

11.7 Control Off

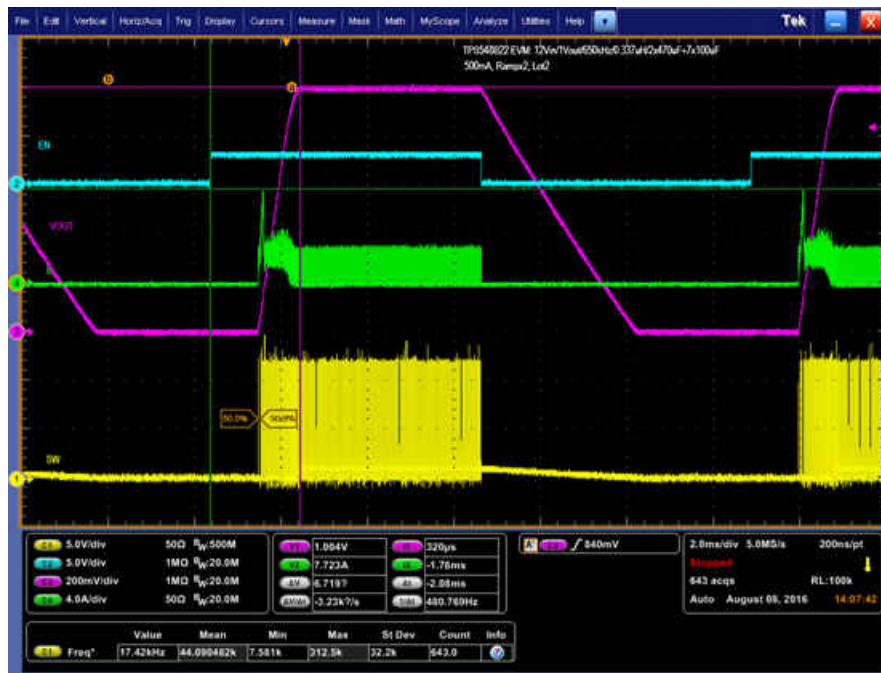

Figure 11-14. Start-Up and Shutdown, 1-V Output at 12 V_{IN}, 0.5-A Output

11.8 Thermal Image

Figure 11-15 illustrates the thermal image at 1-V output at 12 V_{IN}, 25-A output, 650 kHz at 25°C ambient.

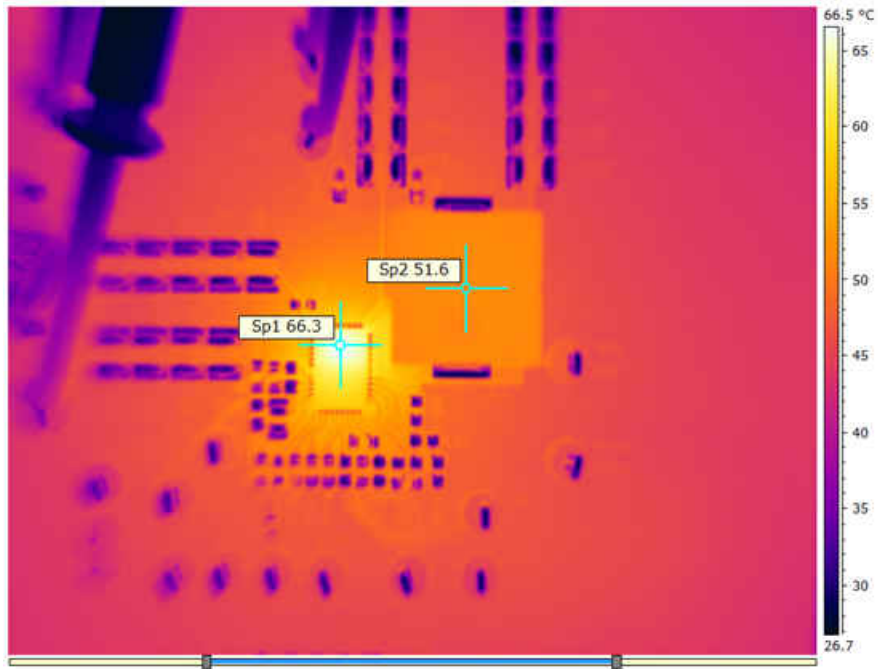

Figure 11-15. Thermal Image at 1-V Output at 12 V_{IN}, 25-A Output, 650 kHz at 25°C Ambient

12 Fusion GUI

Figure 12-1 through Figure 12-4 illustrate the Fusion GUI launch and installation dialog windows.

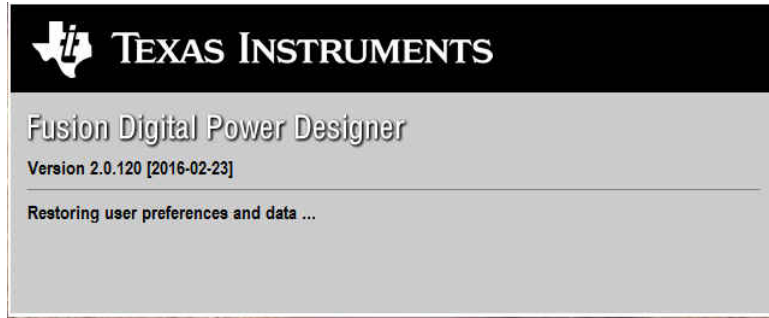

Figure 12-1. First Window at Fusion Launch



Figure 12-2. Scan Finds Device Successfully

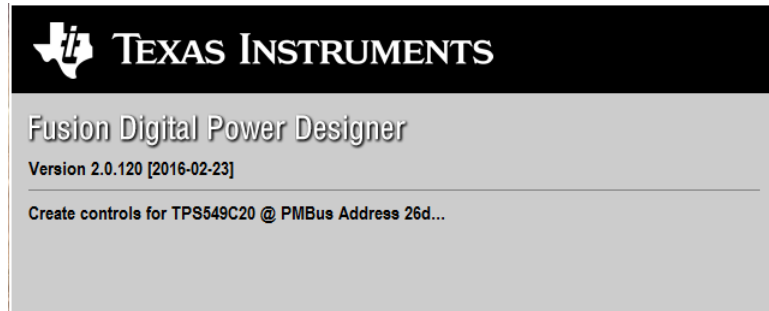

Figure 12-3. Software Launch Continued



Figure 12-4. Software Launch Continued

Use the *All Config* tab to configure all of the configurable parameters (Figure 12-5). The screen also shows other details like hexadecimal (hex) encoding. Use this screen to configure:

- Power Good Delay
- Power On Delay
- Mode Settings
- Frequency, RAMP, DCAP3
- VDD UVLO
- On/Off Configuration
- Track and Sequencing
- Write Protect
- VOUT Command Voltage
- VOUT Margin
- Operation

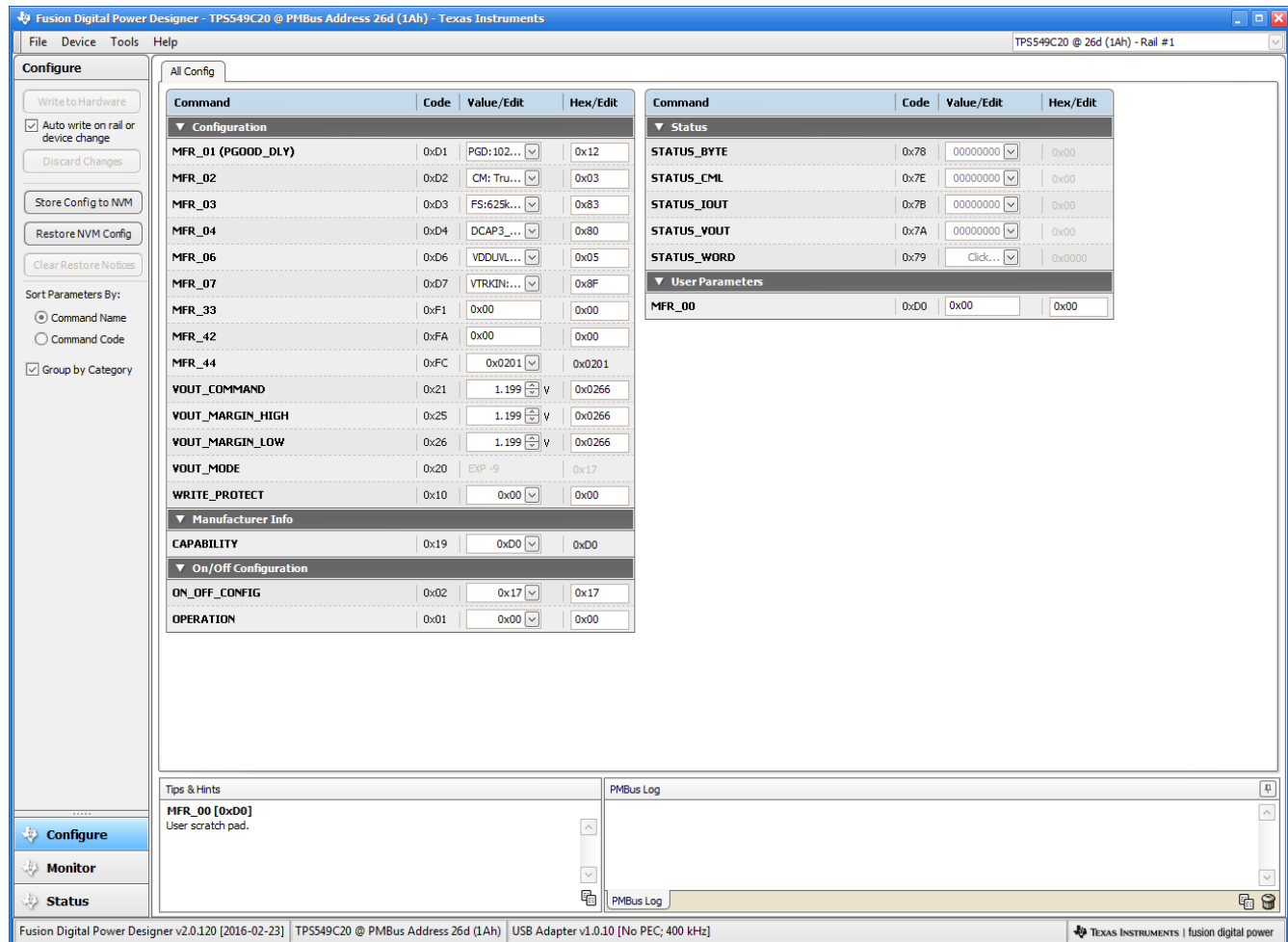

Figure 12-5. First Screen After Successful Launch Configure: Limits and On/Off

Changing the frequency prompts a pop-up window with details of the options [Figure 12-6](#)).

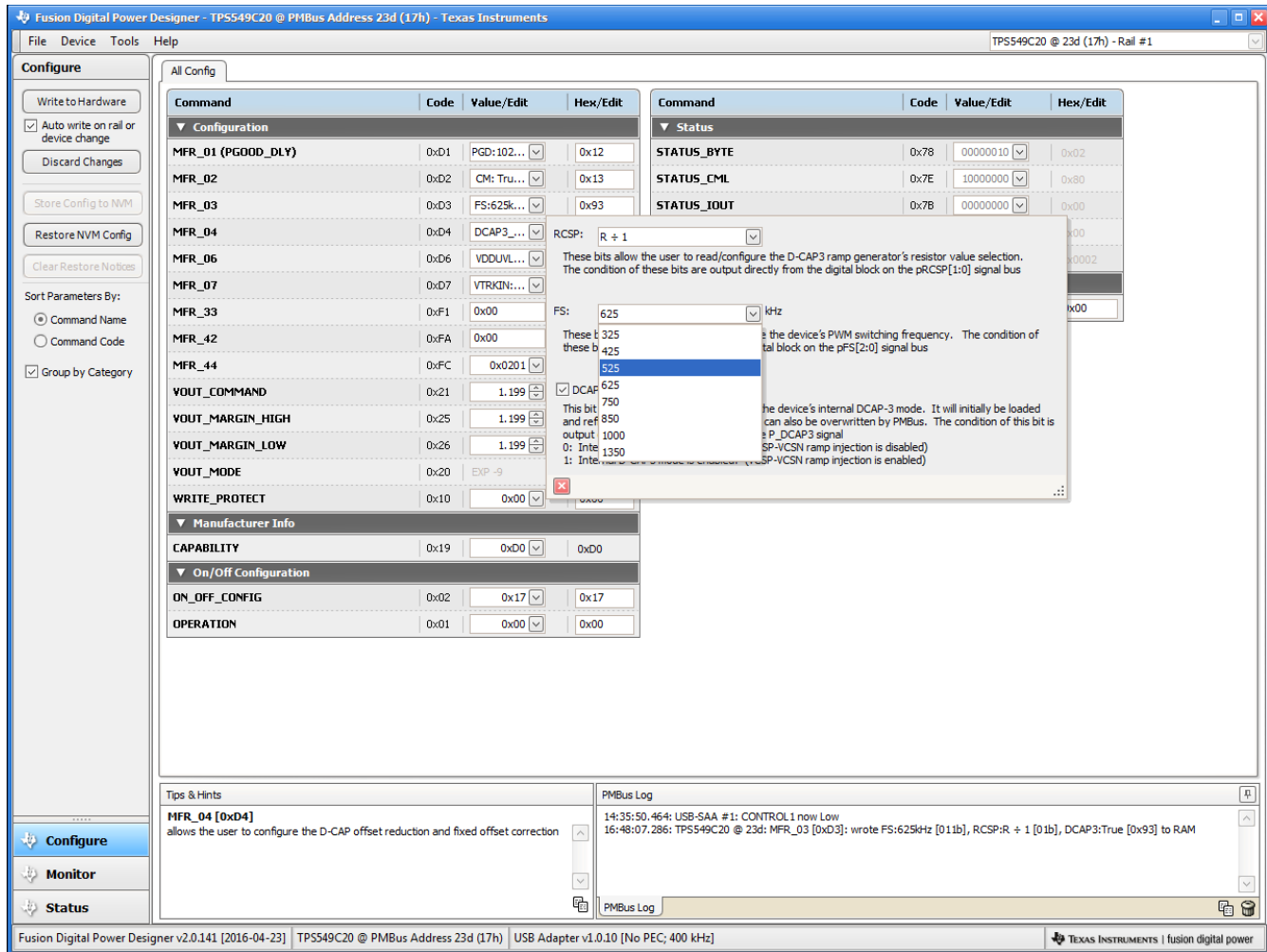

Figure 12-6. Configure: Frequency- FS Configuration Pop-up

After a change is selected, orange **U** icon is displayed to offer *Undo Change* option. Change is not retained until either *Write to Hardware* or *Store Config to NVM* is selected. When *Write to Hardware* is selected, change is committed to volatile memory and defaults back to previous setting on input power cycle. When *Store Config to NVM* is selected, change is committed to nonvolatile memory and becomes the new default (Figure 12-7).

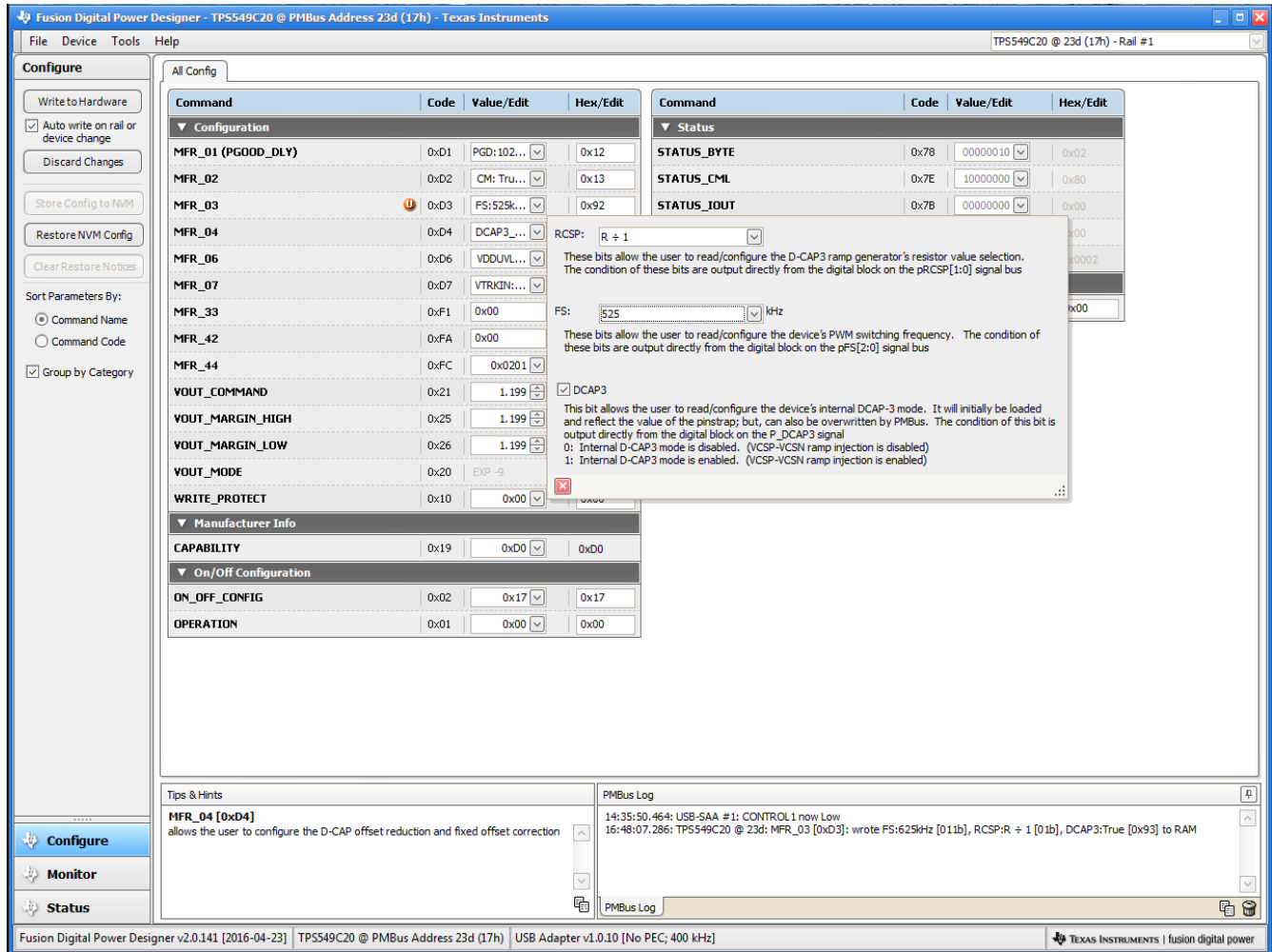

Figure 12-7. Configure: Frequency- FS Config Pop-Up with Change

After making changes to one or more configurable parameters, the changes can be committed to nonvolatile memory by selecting *Store Config to NVM*. This action prompts a *confirm selection* pop-up, and if confirmed, the changes are committed to nonvolatile memory (Figure 12-8).

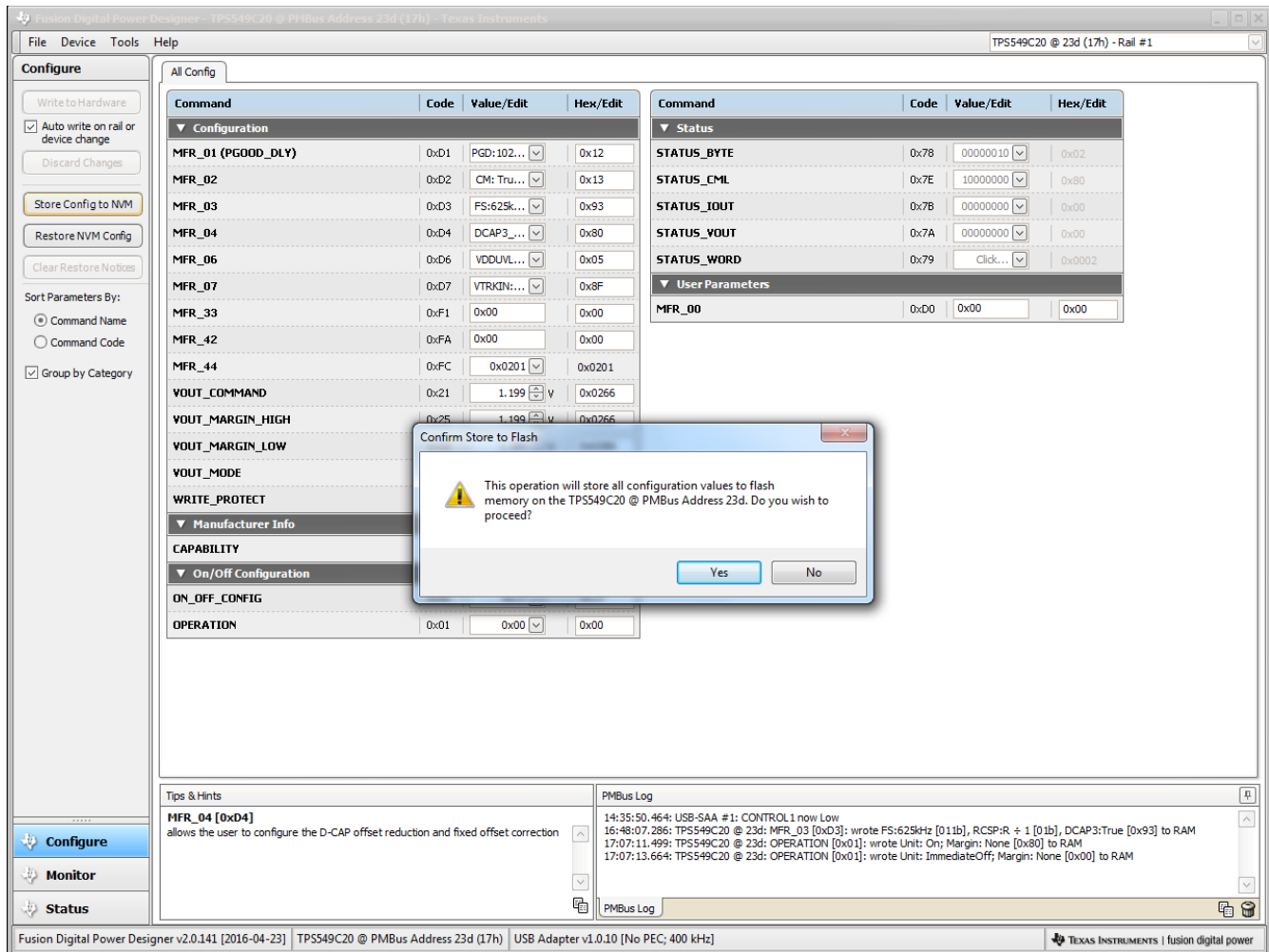

Figure 12-8. Configure: Store Config to NVM

In the lower left corner, the different view screens can be changed. The view screens can be changed between *Configure*, *Monitor* and *Status* as needed (Figure 12-9).

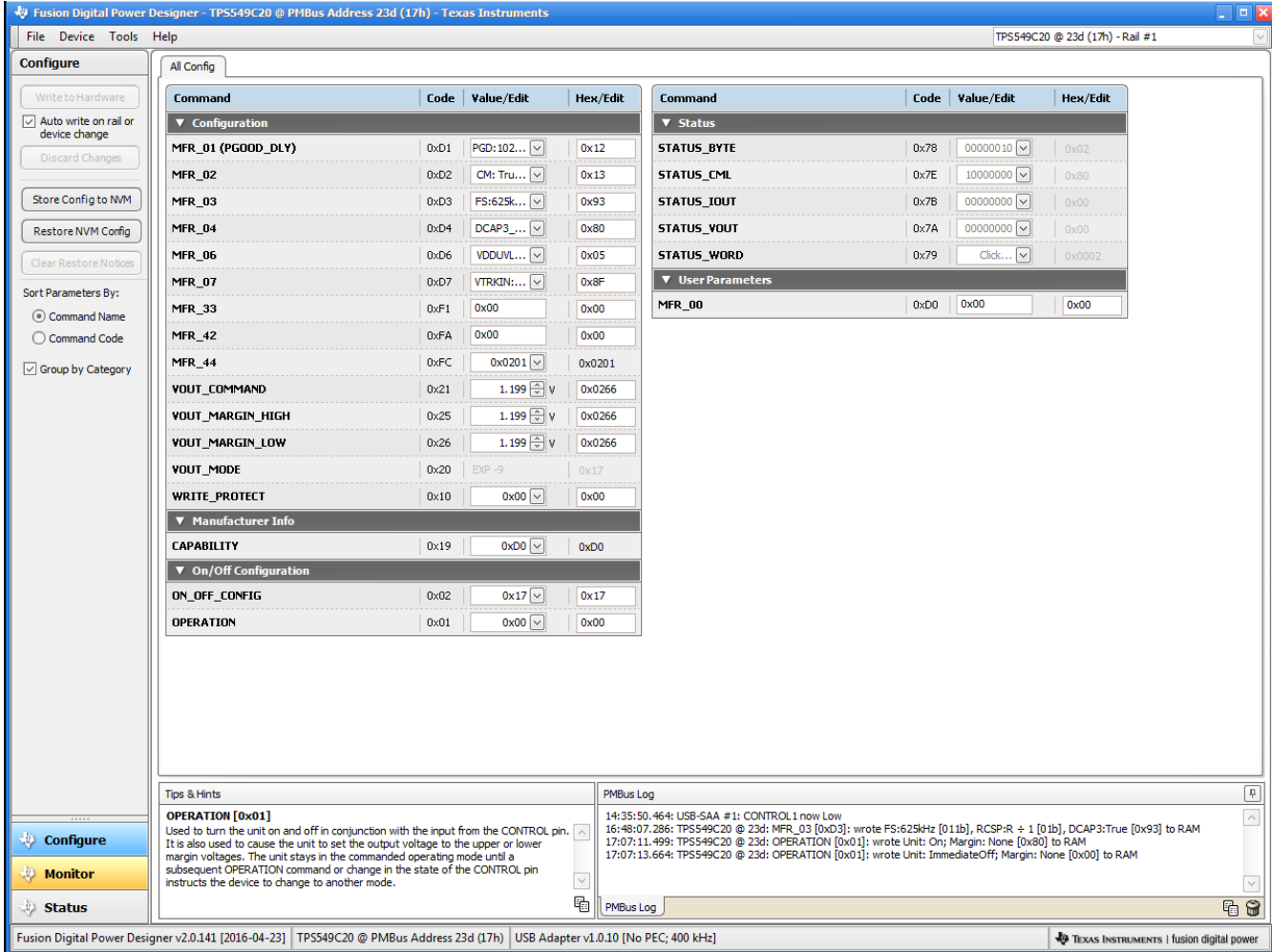

Figure 12-9. Change View Screen to Monitor Screen

Selecting *System Dashboard* from mid-left screen adds a new window which displays system-level information (Figure 12-10).

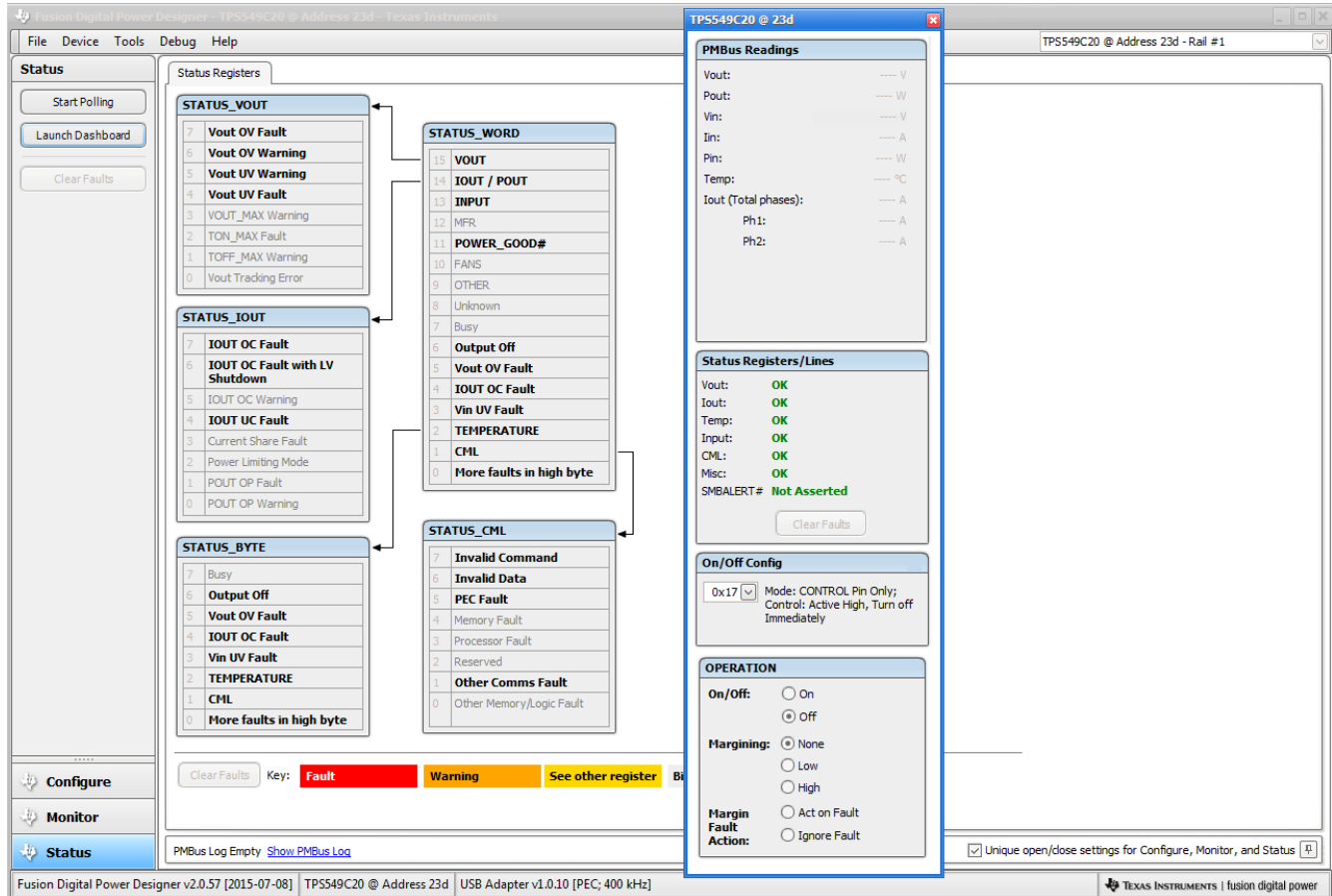

Figure 12-10. System Dashboard

Selecting *Status* from lower left corner shows the status of the controller (Figure 12-11).

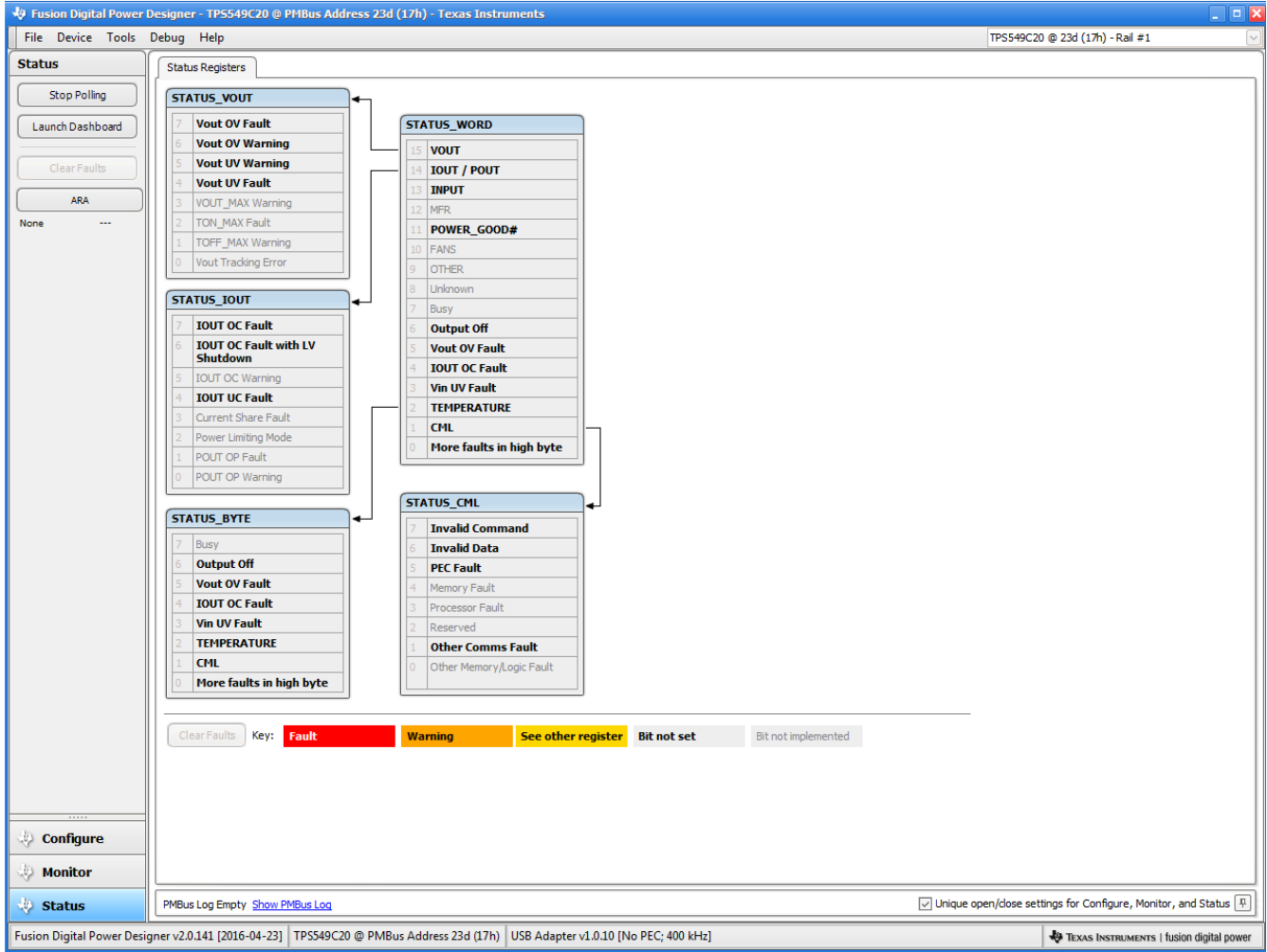

Figure 12-11. Status Screen

Selecting *Store User Configuration to Flash Memory* from the device pull-down menu has the same functionality as the *Store Config to NVM* button from the configure screen. It results in committing the current configuration to nonvolatile memory (Figure 12-12).

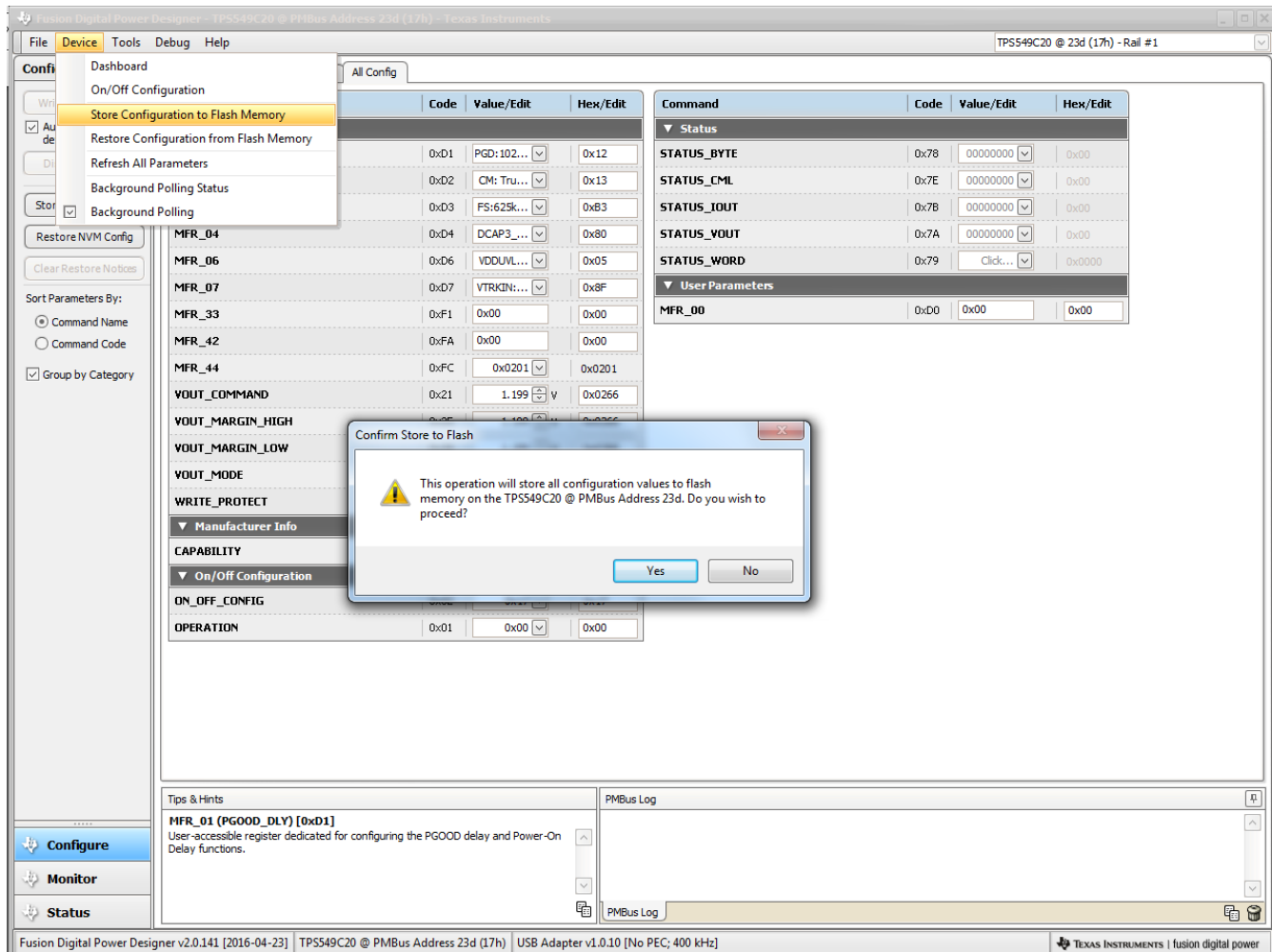

Figure 12-12. Store Configuration To Memory

Selecting *PMBus Logging* (Figure 12-13) from the Tools drop-down menu enables the logging of all PMBus activity. This includes communications traffic for each polling loop between the GUI and the device. The user is prompted to select a location for the file to be stored. See next screen (Figure 12-14).

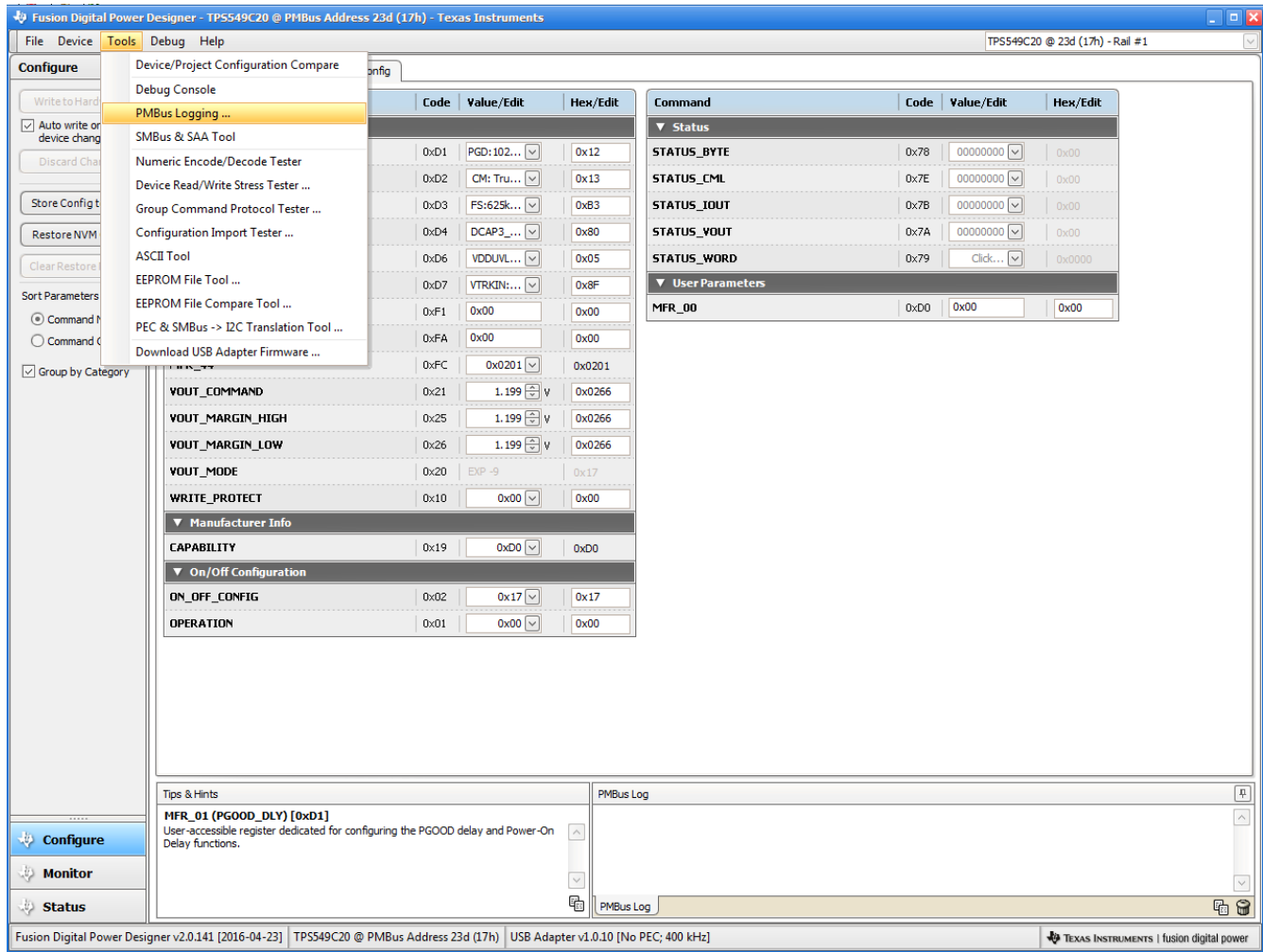

Figure 12-13. PMBus Logging

Select the storage location for the file and the type of file. As shown (Figure 12-14), the file is a CSV file to be stored in the directory path shown. Logging begins when the *Start Logging* button is selected, and stops when it is reselected (as *Stop Logging*). This file can rapidly grow in size, so caution is advised when using this function.

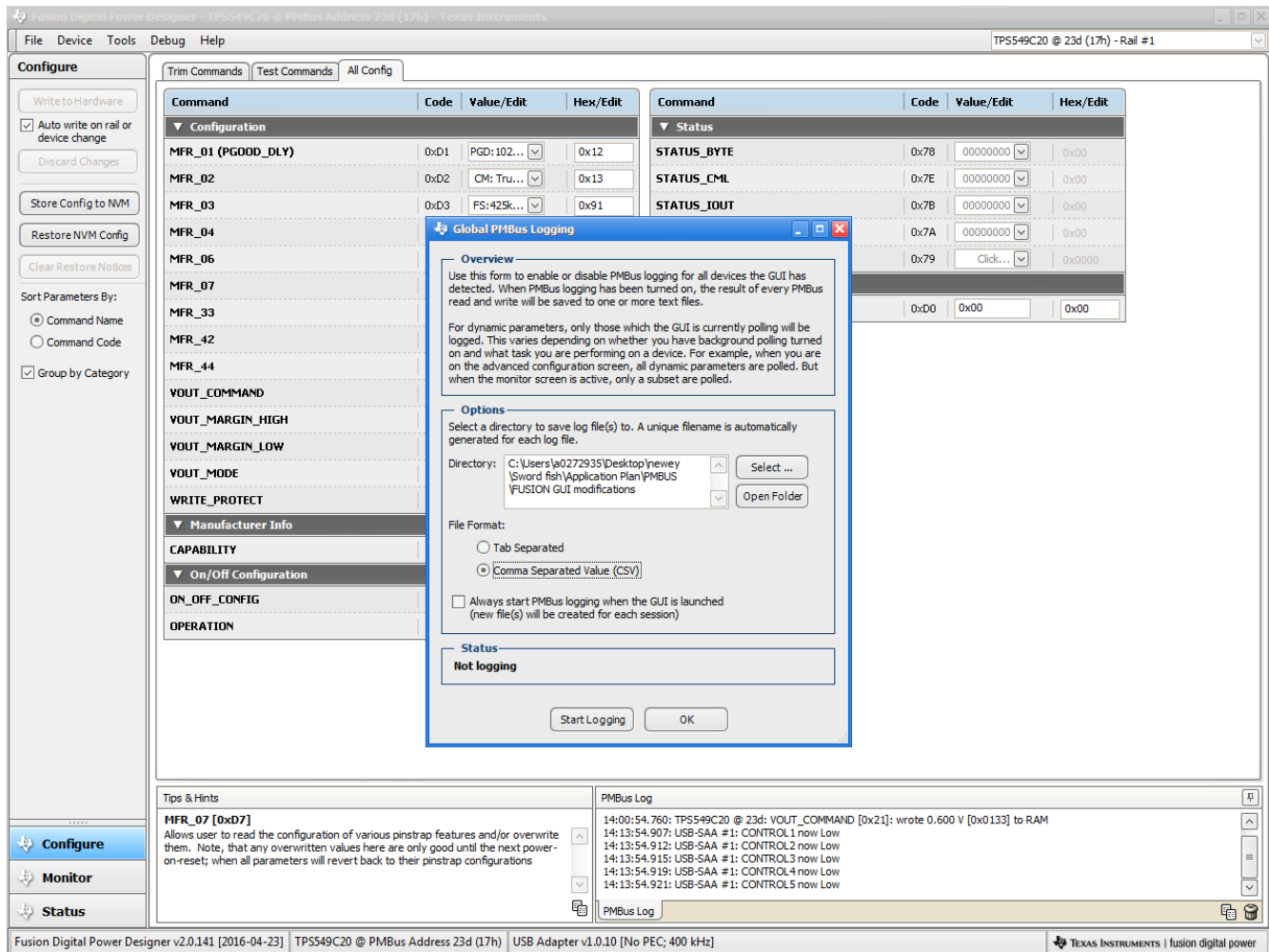

Figure 12-14. PMBus Log Details

13 EVM Assembly Drawing and PCB Layout

Figure 13-1 through Figure 13-10 show the design of the PWR-847EVM printed-circuit board (PCB). The PWR-847EVM has a 2-oz. copper finish for all layers.

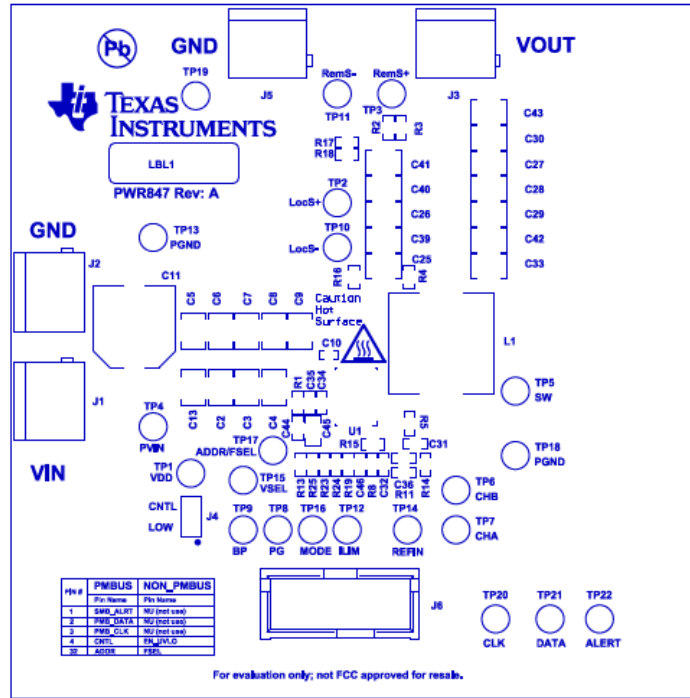

Figure 13-1. PWR-847EVM Top Layer Assembly Drawing (Top View)

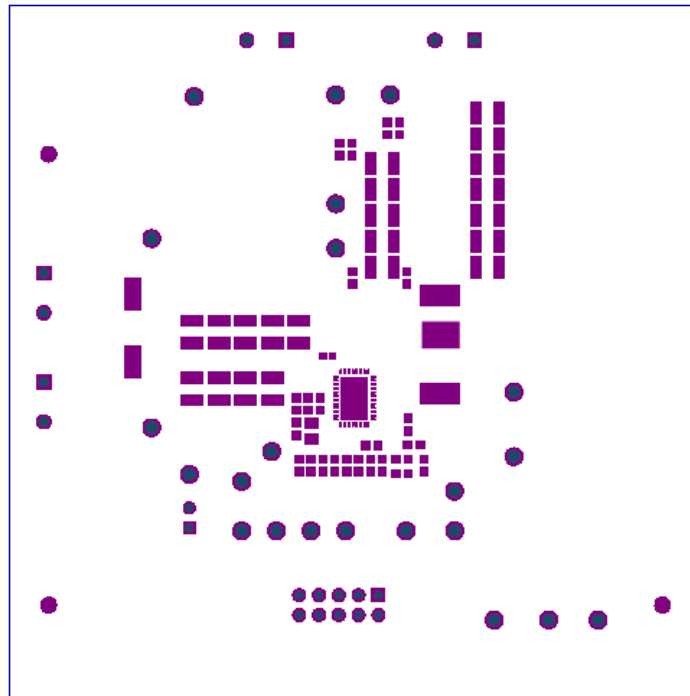

Figure 13-2. PWR-847EVM Top Solder Mask (Top View)

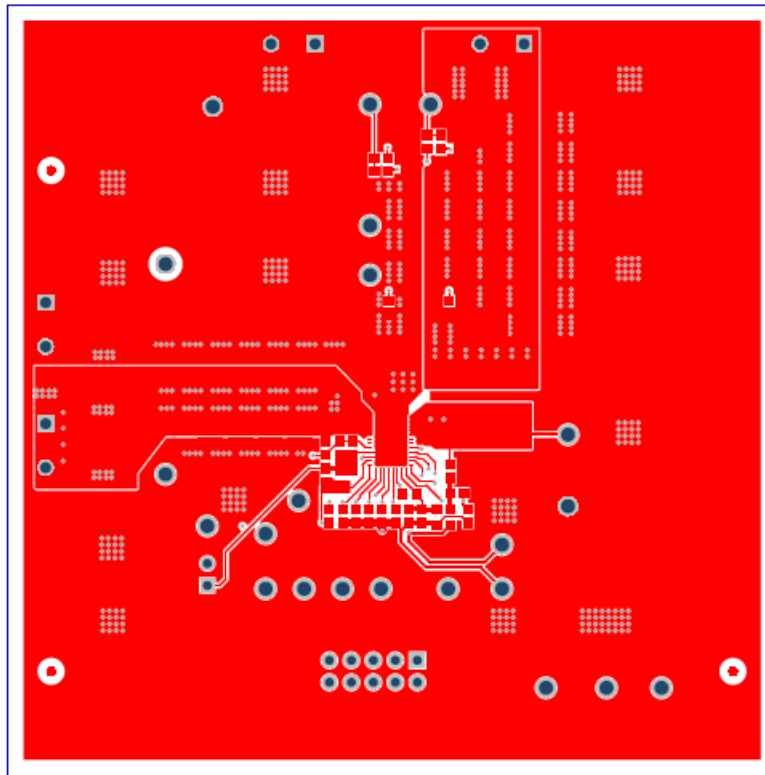

Figure 13-3. PWR-847EVM Top Layer (Top View)

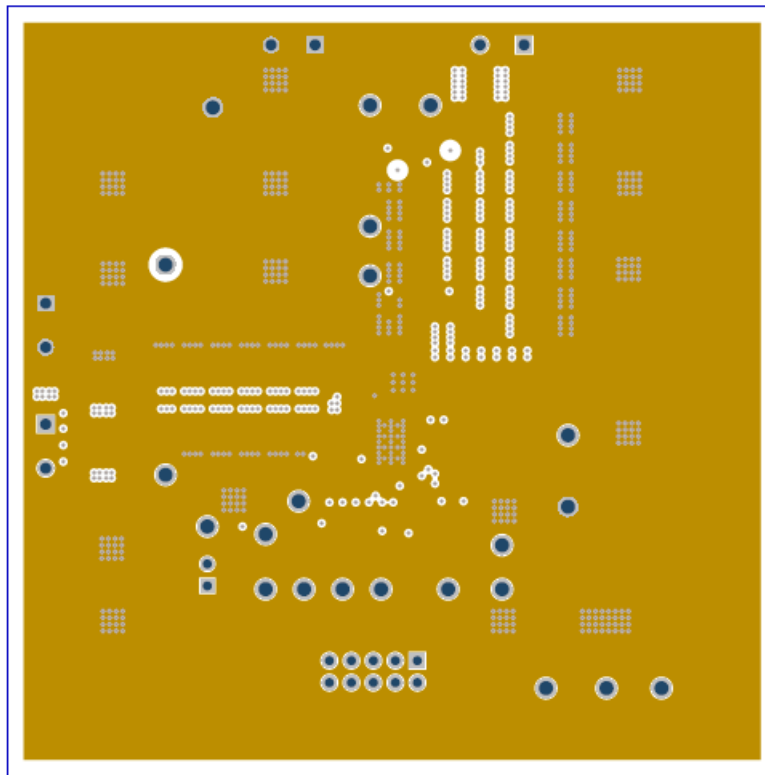

Figure 13-4. PWR-847EVM Inner Layer 1 (Top View)

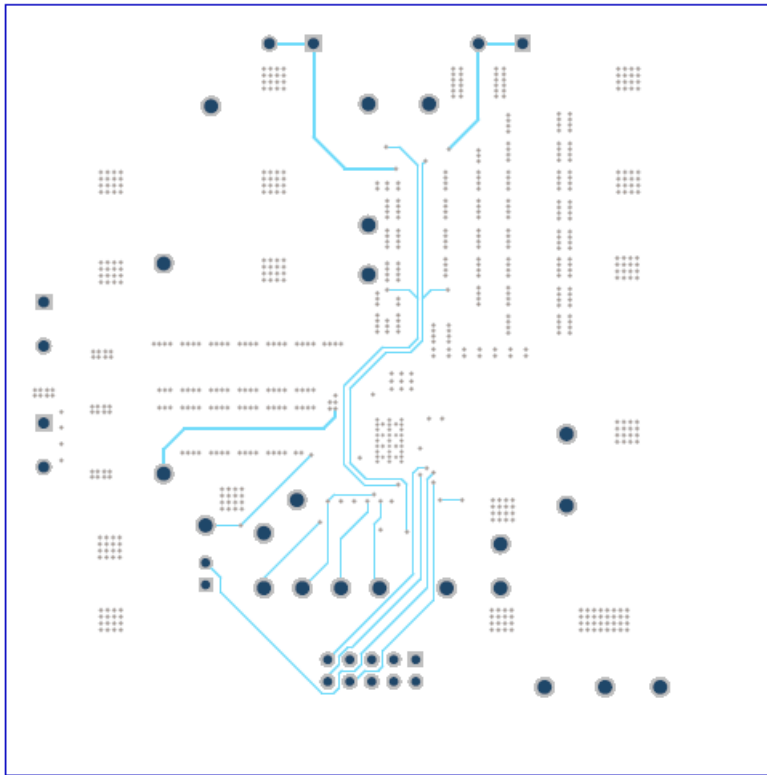

Figure 13-5. PWR-847EVM Inner Layer 2 (Top View)

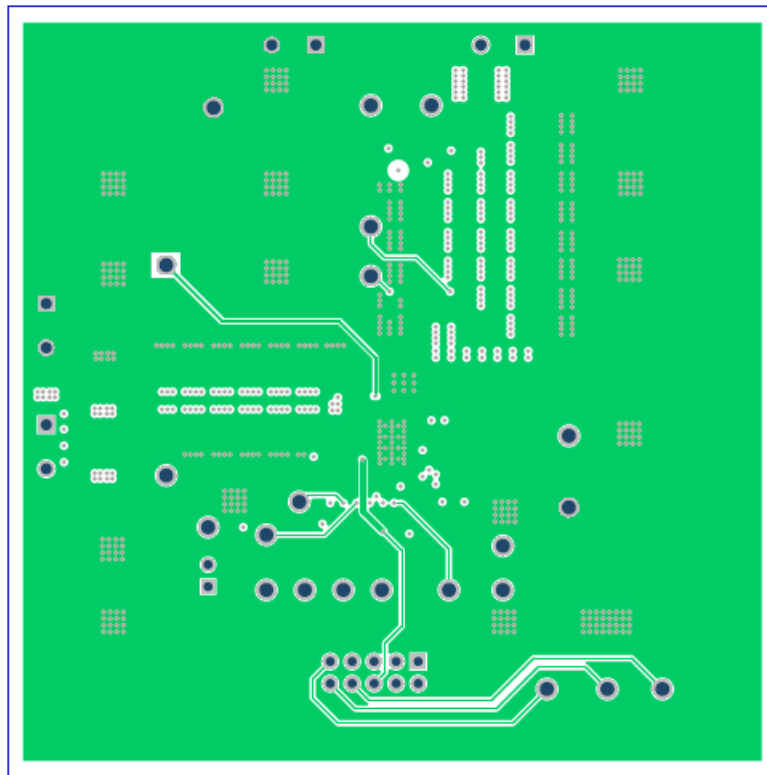

Figure 13-6. PWR-847EVM Inner Layer 3 (Top View)

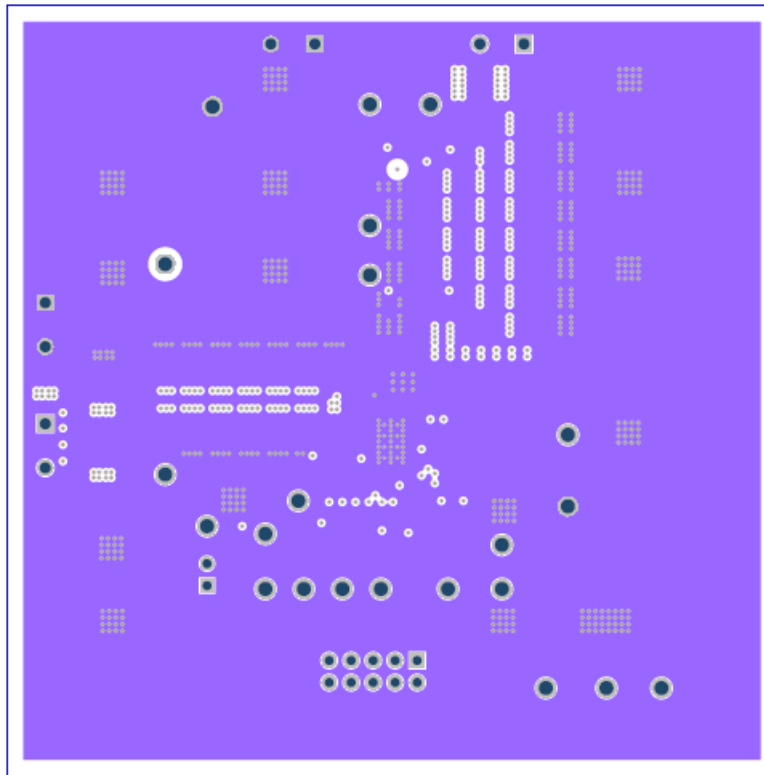

Figure 13-7. PWR-847EVM Inner Layer 4 (Top View)

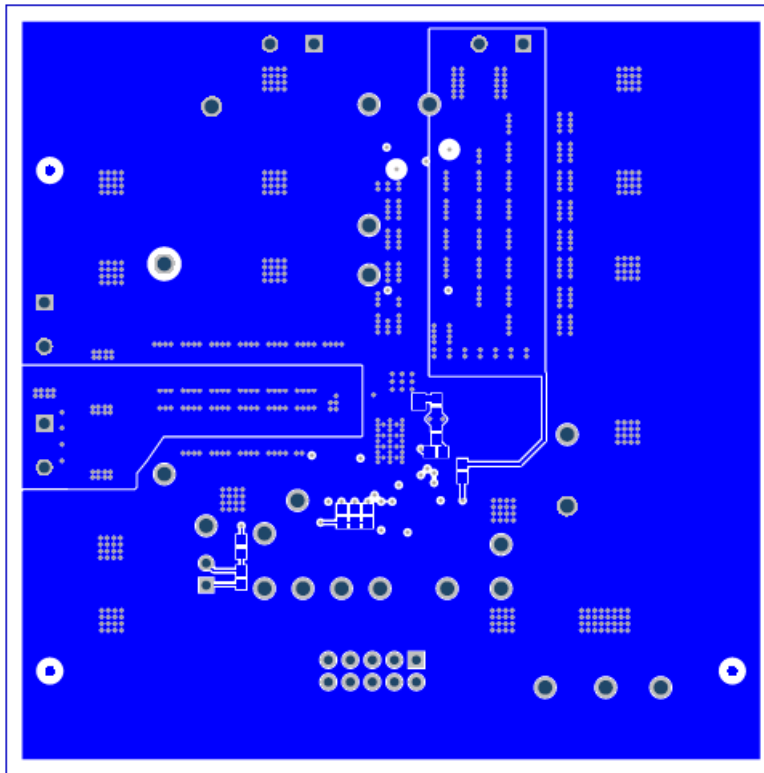

Figure 13-8. PWR-847EVM Bottom Layer (Top View)

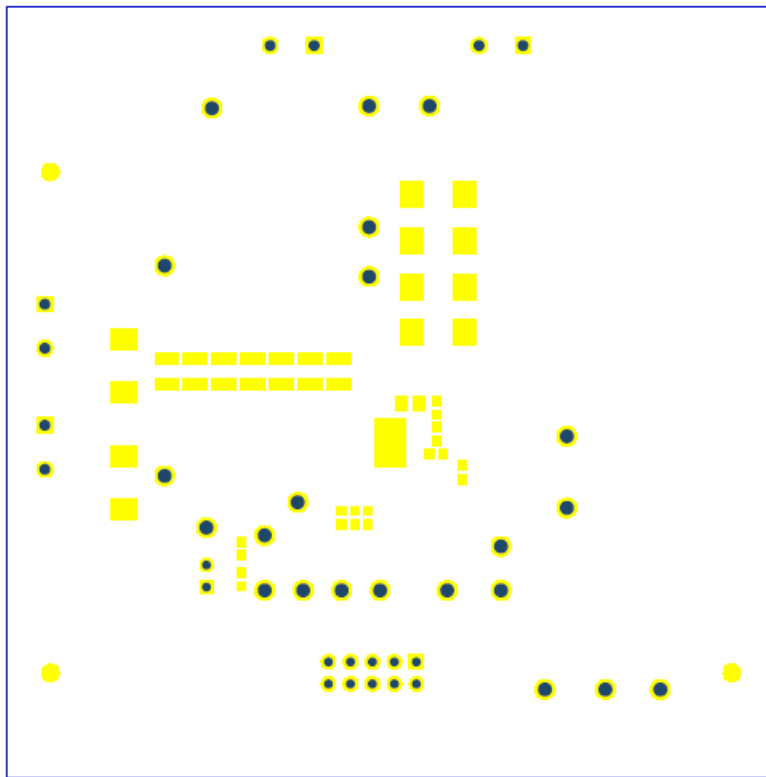

Figure 13-9. PWR-847EVM Bottom Solder Mask (Top View)

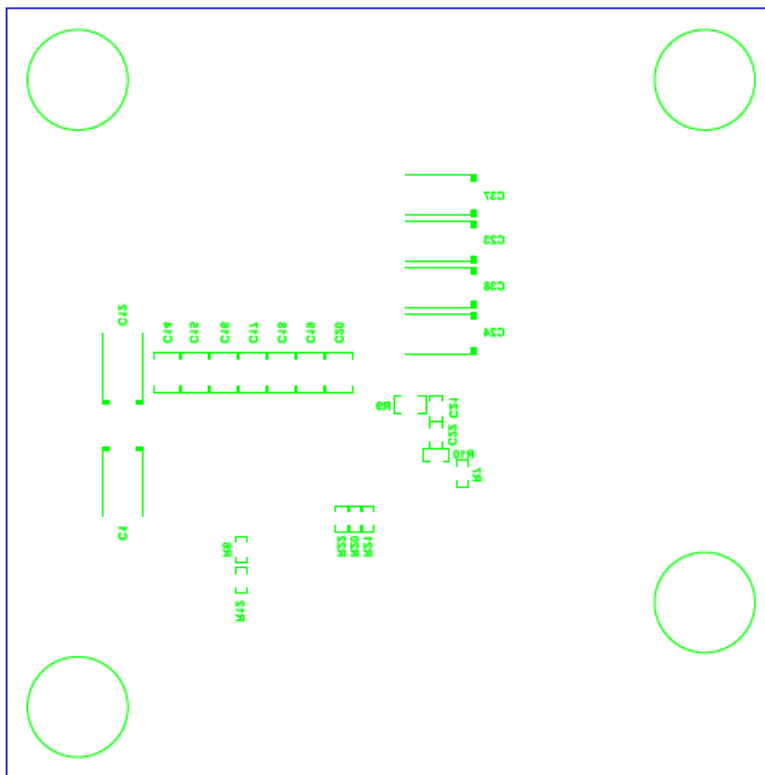

Figure 13-10. PWR-847EVM Bottom Overlay Layer (Top View)

14 List of Materials

The EVM components list, according to the schematic, is shown in [Table 14-1](#).

Table 14-1. PWR847 List of Materials

Designator	Qty	Value	Description	Package Reference	Part Number	Manufacturer	Alternate Part Number	Alternate Manufacturer
!PCB1	1		Printed Circuit Board		PWR847	Any		
C2, C3, C4, C5, C6, C7, C8, C9, C13	9	22uF	CAP, CERM, 22 μ F, 25 V, +/- 10%, X7R, 1210	1210	GRM32ER71E226KE15L	Murata		
C10	1	2200pF	CAP, CERM, 2200 pF, 25 V, +/- 10%, X5R, 0402	0402	GRM155R61E222KA01D	Murata		
C11	1	100uF	CAP, AL, 100uF, 35V, +/-20%, 0.15 ohm, SMD	SMT Radial G	EEE-FC1V101P	Panasonic		
C22	1	0.1uF	CAP, CERM, 0.1 μ F, 50 V, +/- 10%, X7R, 0603	0603	GRM188R71H104KA93D	Murata		
C24, C38	2	470uF	CAP, Tantalum Polymer, 470 μ F, 2.5 V, +/- 20%, 0.006 ohm, 7.3x2.8x4.3mm SMD	7.3x2.8x4.3mm	2R5TPF470M6L	Panasonic		
C25, C26, C29, C33, C39, C40, C42	7	100uF	CAP, CERM, 100 μ F, 6.3 V, +/- 20%, X5R, 1210	1210	GRM32ER60J107ME20L	Murata		
C35	1	1uF	CAP, CERM, 1 μ F, 16 V, +/- 10%, X5R, 0603	0603	C0603C105K4PACTU	Kemet		
C45	1	4.7uF	CAP, CERM, 4.7 μ F, 16 V, +/- 10%, X7R, 0805	0805	GRM21BR71C475KA73L	Murata		
H9, H10, H11, H12	4		Bumpon, Hemisphere, 0.44 X 0.20, Clear	Transparent Bumpon	SJ-5303 (CLEAR)	3M		
J1, J2, J3, J5	4		TERMINAL BLOCK 5.08MM VERT 2POS, TH	TERM_BLK, 2pos, 5.08mm	ED120/2DS	On-Shore Technology		
J4	1		Header, 100mil, 2x1, Tin, TH	Header, 2 PIN, 100mil, Tin	PEC02SAAN	Sullins Connector Solutions		
J6	1		Header (shrouded), 100mil, 5x2, Gold, TH	5x2 Shrouded header	5103308-1	TE Connectivity		
L1	1	330nH	Inductor, Shielded Drum Core, Ferrite, 330 nH, 50 A, 0.000165 ohm, SMD	12.5x13mm	744309033	Wurth Elektronik		
LBL1	1		Thermal Transfer Printable Labels, 0.650" W x 0.200" H - 10,000 per roll	PCB Label 0.650"H x 0.200"W	THT-14-423-10	Brady		
R1	1	1.00	RES, 1.00, 1%, 0.1 W, 0603	0603	RC0603FR-071RL	Yageo America		
R4, R7, R10, R11, R16	5	0	RES, 0, 5%, 0.1 W, 0603	0603	CRCW06030000Z0EA	Vishay-Dale		
R6	1	200k	RES, 200 k, 1%, 0.1 W, 0603	0603	CRCW0603200KFKEA	Vishay-Dale		
R8	1	1.10k	RES, 1.10 k, 1%, 0.1 W, 0603	0603	CRCW06031K10FKEA	Vishay-Dale		
R12, R13, R20, R21, R22	5	100k	RES, 100 k, 1%, 0.1 W, 0603	0603	CRCW0603100KFKEA	Vishay-Dale		
R15	1	10.0k	RES, 10.0k ohm, 1%, 0.1W, 0603	0603	CRCW060310K0FKEA	Vishay-Dale		
R19	1	61.9k	RES, 61.9 k, 1%, 0.1 W, 0603	0603	CRCW060361K9FKEA	Vishay-Dale		
R23	1	37.4k	RES, 37.4 k, 1%, 0.1 W, 0603	0603	CRCW060337K4FKEA	Vishay-Dale		
R24	1	42.2k	RES, 42.2 k, 1%, 0.1 W, 0603	0603	CRCW060342K2FKEA	Vishay-Dale		
R25	1	25.5k	RES, 25.5 k, 1%, 0.1 W, 0603	0603	CRCW060325K5FKEA	Vishay-Dale		

Table 14-1. PWR847 List of Materials (continued)

Designator	Qty	Value	Description	Package Reference	Part Number	Manufacturer	Alternate Part Number	Alternate Manufacturer
TP1, TP5, TP6, TP7, TP8, TP9, TP12, TP14, TP15, TP16, TP17, TP20, TP21, TP22	14	White	Test Point, Multipurpose, White, TH	White Multipurpose Testpoint	5012	Keystone		
TP2, TP3, TP4	3	Red	Test Point, Multipurpose, Red, TH	Red Multipurpose Testpoint	5010	Keystone		
TP10, TP11, TP13, TP18, TP19	5	Black	Test Point, Multipurpose, Black, TH	Black Multipurpose Testpoint	5011	Keystone		
U1	1		1.5-V to 16-V VIN, 4.5-V to 22-V VDD, 25-A SWIFT Synchronous Step-Down Converter with Full Differential Sense, RVF0040A (LQFN-CLIP-40)	RVF0040A	TPS549B22RVFR	Texas Instruments	TPS549B22RVFT	Texas Instruments
C1, C12	0	330uF	CAP, TA, 330 μ F, 6.3 V, +/- 20%, 0.025 ohm, SMD	7.3x2.8x4.3mm	6TPE330ML	Sanyo		
C14, C15, C16, C17, C18, C19, C20	0	22uF	CAP, CERM, 22 μ F, 25 V, +/- 10%, X7R, 1210	1210	GRM32ER71E226KE15L	Murata		
C21	0	470pF	CAP, CERM, 470 pF, 50 V, +/- 10%, X7R, 0603	0603	GRM188R71H471KA01D	Murata		
C23, C37	0	470uF	CAP, Tantalum Polymer, 470 μ F, 2.5 V, +/- 20%, 0.006 ohm, 7.3x2.8x4.3mm SMD	7.3x2.8x4.3mm	2R5TPF470M6L	Panasonic		
C27, C28, C30, C41, C43	0	100uF	CAP, CERM, 100 μ F, 6.3 V, +/- 20%, X5R, 1210	1210	GRM32ER60J107ME20L	Murata		
C31	0	0.1uF	CAP, CERM, 0.1 μ F, 50 V, +/- 10%, X7R, 0603	0603	GRM188R71H104KA93D	Murata		
C32	0	6800pF	CAP, CERM, 6800 pF, 50 V, +/- 10%, X7R, 0603	0603	GRM188R71H682KA01D	Murata		
C34, C44	0	1uF	CAP, CERM, 1 μ F, 16 V, +/- 10%, X5R, 0603	0603	C0603C105K4PACTU	Kemet		
C36	0	1000pF	CAP, CERM, 1000 pF, 25 V, +/- 10%, X7R, 0603	0603	GRM188R71E102KA01D	Murata		
C46	0	1000pF	CAP, CERM, 1000 pF, 50 V, +/- 5%, C0G/NP0, 0603	0603	C0603C102J5GACTU	Kemet		
FID1, FID2, FID3, FID4, FID5, FID6	0		Fiducial mark. There is nothing to buy or mount.	Fiducial	N/A	N/A		
R2, R3, R14, R17, R18	0	0	RES, 0, 5%, 0.1 W, 0603	0603	CRCW06030000Z0EA	Vishay-Dale		
R5	0	1.50k	RES, 1.50 k, 1%, 0.1 W, 0603	0603	RC0603FR-071K5L	Yageo America		
R9	0	3.01	RES, 3.01 ohm, 1%, 0.125W, 0805	0805	CRCW08053R01FKEA	Vishay-Dale		
Notes: Unless otherwise noted in the Alternate Part Number or Alternate Manufacturer columns, all parts may be substituted with equivalents.								

15 Revision History

NOTE: Page numbers for previous revisions may differ from page numbers in the current version.

Changes from Revision * (March 2017) to Revision A (August 2021)	Page
• Updated user's guide title.....	3
• Updated the numbering format for tables, figures, and cross-references throughout the document.	3

IMPORTANT NOTICE AND DISCLAIMER

TI PROVIDES TECHNICAL AND RELIABILITY DATA (INCLUDING DATA SHEETS), DESIGN RESOURCES (INCLUDING REFERENCE DESIGNS), APPLICATION OR OTHER DESIGN ADVICE, WEB TOOLS, SAFETY INFORMATION, AND OTHER RESOURCES "AS IS" AND WITH ALL FAULTS, AND DISCLAIMS ALL WARRANTIES, EXPRESS AND IMPLIED, INCLUDING WITHOUT LIMITATION ANY IMPLIED WARRANTIES OF MERCHANTABILITY, FITNESS FOR A PARTICULAR PURPOSE OR NON-INFRINGEMENT OF THIRD PARTY INTELLECTUAL PROPERTY RIGHTS.

These resources are intended for skilled developers designing with TI products. You are solely responsible for (1) selecting the appropriate TI products for your application, (2) designing, validating and testing your application, and (3) ensuring your application meets applicable standards, and any other safety, security, regulatory or other requirements.

These resources are subject to change without notice. TI grants you permission to use these resources only for development of an application that uses the TI products described in the resource. Other reproduction and display of these resources is prohibited. No license is granted to any other TI intellectual property right or to any third party intellectual property right. TI disclaims responsibility for, and you will fully indemnify TI and its representatives against, any claims, damages, costs, losses, and liabilities arising out of your use of these resources.

TI's products are provided subject to [TI's Terms of Sale](#) or other applicable terms available either on ti.com or provided in conjunction with such TI products. TI's provision of these resources does not expand or otherwise alter TI's applicable warranties or warranty disclaimers for TI products.

TI objects to and rejects any additional or different terms you may have proposed.

Mailing Address: Texas Instruments, Post Office Box 655303, Dallas, Texas 75265
Copyright © 2022, Texas Instruments Incorporated