

Using the TPS546C23 Two Separated, Single-Phase Evaluation Module

The TPS546C23EVM1-746 evaluation module (EVM) uses two TPS546C23 devices. The TPS546C23 device is a stackable synchronous buck with PMBus interface that can operate from a nominal 4.5-V to 18-V supply. The device allows programming and monitoring via the PMBus interface.

Two TPS546C23 devices are configured as two separated single phase buck converter in factory default; the negative terminals of the two outputs are connected together internally, while the positive terminals are separated.

Contents

1	Description	3
	1.1 Typical Applications	3
	1.2 Features	3
2	Electrical Performance Specifications	4
3	Schematic	4
4	Test Setup	6
	4.1 Test and Configuration Software	6
	4.2 Test Equipment	6
	4.3 Recommended Test Setup	7
	4.4 List of Test Points, Jumpers and Connectors	8
5	EVM Configuration Using the Fusion GUI	10
	5.1 Configuration Procedure	10
6	Test Procedure	12
	6.1 Line and Load Regulation and Efficiency Measurement Procedure	12
	6.2 Control Loop Gain and Phase Measurement Procedure	12
	6.3 Efficiency Measurement	13
7	Performance Data and Typical Characteristic Curves	14
	7.1 Efficiency	14
	7.2 Load Regulation	14
	7.3 Line Regulation	15
	7.4 Transient Response	15
	7.5 Output Ripple	15
	7.6 Control On	16
	7.7 Control Off	17
	7.8 Control On under Pre-bias	17
	7.9 Overcurrent Protection	18
	7.10 Control Loop Bode Plot	18
	7.11 Thermal Image	20
8	EVM Assembly Drawing and PCB Layout	21
9	Bill of Materials	26
10	Screenshots	28
	10.1 Fusion GUI Screenshots	28

List of Figures

1	TPS546C23EVM1-746 Schematic	5
2	TPS546C23EVM1-746 EVM Recommended Test Set Up For Output #1	7

3	TPS546C23EVM1-746 EVM Recommended Test Set Up For Output #2	7
4	Tip and Barrel Measurement	8
5	Efficiency of 0.9-V Output vs Line and Load	14
6	Load Regulation of 0.9-V Output	14
7	Line Regulation of 0.9-V Output (Different Board)	15
8	Transient Response of 0.9-V Output at 12 V _{IN} , Transient is 10 A to 30 A, 0.2 A/μs	15
9	Output Ripple and SW Node of 0.9-V Output at 12 V _{IN} , 0-A Output	15
10	Output Ripple and SW Node of 0.9-V Output at 12 V _{IN} , 35-A Output	16
11	Start up from Control, 0.9-V Output at 12 V _{IN} , 0-A Output	16
12	Start up from Control, 0.9-V Output at 12 V _{IN} , 35-A Output	16
13	Soft Stop from Control, 0.9-V Output at 12 V _{IN} , 35-A Output	17
14	0.6-V Pre-bias start up from Control, 0.9-V Output at 12 V _{IN} , 0-A Output	17
15	Overcurrent Protection, 0.9-V Output at 12 V _{IN} , 35-A Output (OC_Fault threshold is modified to 35A)	18
16	Bode Plot at 0.9-V Output at 12 V _{IN} , 0-A Output	18
17	Bode Plot at 0.9-V Output at 12 V _{IN} , 35-A Output	19
18	Thermal Image	20
19	Thermal Image	20
20	TPS546C23EVM1-746 EVM 3D Top View	21
21	TPS546C23EVM1-746 EVM Top Layer Assembly Drawing (Top View)	21
22	TPS546C23EVM1-746 EVM Bottom Assembly Drawing (Bottom View)	22
23	TPS546C23EVM1-746 EVM Top Copper (Top View)	22
24	TPS546C23EVM1-746 EVM Internal Layer 1 (Top View)	23
25	TPS546C23EVM1-746 EVM Internal Layer 2 (Top View)	23
26	TPS546C23EVM1-746 EVM Internal Layer 3 (Top View)	24
27	TPS546C23EVM1-746 EVM Internal Layer 4 (Top View)	24
28	TPS546C23EVM1-746 EVM Bottom Copper (Top View)	25
29	Select Device Scanning Mode	28
30	Configure- Limits and On/Off	29
31	ON/OFF Control Pop-up	30
32	Configure - Advanced	31
33	Configure - SMBALERT # Mask	32
34	Configure - Device Info	33
35	Configure - All Config	34
36	Monitor Screen	35
37	Status Screen	36

List of Tables

1	TPS546C23EVM1-746 Electrical Performance Specifications	4
2	Test Point Functions	8
3	Jumpers	9
4	Connector Functions	9
5	Key Factory Configuration Parameters	10
6	List of Test Points for Loop Response Measurements	12
7	Test Points for Better Efficiency Measurements	13
8	TPS546C23EVM1-746 Components List	26

1 Description

The TPS546C23EVM1-746 includes two separated buck converters. It uses a nominal 12-V bus to produce two regulated 0.9-V outputs at up to 35 A of load current. The TPS546C23EVM1-746 is designed to demonstrate the TPS546C23 in a typical single phase low output voltage application while providing a number of test points to evaluate the performance of the device. The TPS546C23EVM1-746 is NOT recommended to be modified to two-phase interleaving buck converter by changing the bill of materials (BOM). Refer to the TPS546C23 ([SLUSCC7](#)) datasheet for more information on multi-phase configuration.

1.1 Typical Applications

- High-density power solutions
- Wireless infrastructure
- Switcher
- Router Network
- Server
- Storage
- Smart power systems

1.2 Features

- Two regulated 0.9-V outputs up to 35-A DC steady-state output current
- Both outputs are marginable and trimmable via the PMBus interface
 - Programmable UVLO, soft-start, and enable via the PMBus interface
 - Programmable overcurrent warning and fault limits and programmable response to faults via the PMBus interface
 - Programmable overvoltage and undervoltage warning and fault limits and programmable response to faults via the PMBus interface
 - Programmable turn-on and turn-off delays
- Convenient test points for probing critical waveforms

2 Electrical Performance Specifications

Table 1 lists the electrical performance specifications under room temperature 25°C.

Table 1. TPS546C23EVM1-746 Electrical Performance Specifications

Parameter	Test Conditions	MIN	TYP	MAX	Unit
Input Characteristics					
Voltage range	V_{IN}	5	12	18	V
Maximum input current	$V_{IN} = 12\text{ V}$, $I_{O1} = 35\text{ A}$, $I_{O2} = 35\text{ A}$		6.5		A
No load input current	$V_{IN} = 12\text{ V}$, $I_{O1} = 0\text{ A}$, $I_{O2} = 0\text{ A}$		100		mA
Output Characteristics					
Output voltage, V_{OUT1}			0.9		V
Output voltage, V_{OUT2}			0.9		V
Output load current, I_{OUT1} ⁽¹⁾		0		35	A
Output load current, I_{OUT2} ⁽¹⁾		0		35	A
Output voltage regulation	Line Regulation: Input voltage = 5 V to 18 V		1%		
	Load Regulation: Output current = 0 A to 35 A, both outputs		1%		
Output voltage ripple, V_{OUT1}	$V_{IN} = 12\text{ V}$, $I_{OUT1} = 35\text{ A}$		10		mVpp
Output voltage ripple, V_{OUT2}	$V_{IN} = 12\text{ V}$, $I_{OUT2} = 35\text{ A}$		10		mVpp
Output Over-current Protection Threshold	Load current I_{OUT1} , default setting		42		A
	Load current I_{OUT2} , default setting		42		A
Systems Characteristics					
Switching frequency	$V_{IN} = 12\text{ V}$		500		kHz
Full load efficiency, V_{OUT1} ⁽²⁾	$V_{IN} = 12\text{ V}$, $I_{O1} = 35\text{ A}$, V_{OUT2} disabled		84%		
Full load efficiency, V_{OUT2} ⁽²⁾	$V_{IN} = 12\text{ V}$, $I_{O2} = 35\text{ A}$, V_{OUT1} disabled		84%		
Operating temperature	T_{oper}		25		°C
PMBUS Interface and Pin-Strapping					
U1 PMBUS Address	Programmed by R_{33} and R_{35}		27		Decimal
U2 PMBus Address	Programmed by R_{37} and R_{36}		36		
U1 Voltage reference	Default setting of VOUT_COMMAND		600		mV
U2 Voltage reference	Default setting of VOUT_COMMAND		600		
U1 Soft-start time (TON_RISE)	Default setting of TON_RISE		3		ms
U2 Soft-start time (TON_RISE)	Default setting of TON_RISE		3		

⁽¹⁾ The output current I_{OUT1} and I_{OUT2} can be up to 40 A, if the output overcurrent limit (IOUT_OC_FAULT_LIMIT) is set to 45 A.

⁽²⁾ The efficiency is measured based on Figure 2 and Figure 3 test setups, which includes power loss caused by on board copper traces.

3 Schematic

Figure 1 illustrates the TPS546C23EVM1-746 EVM schematic.

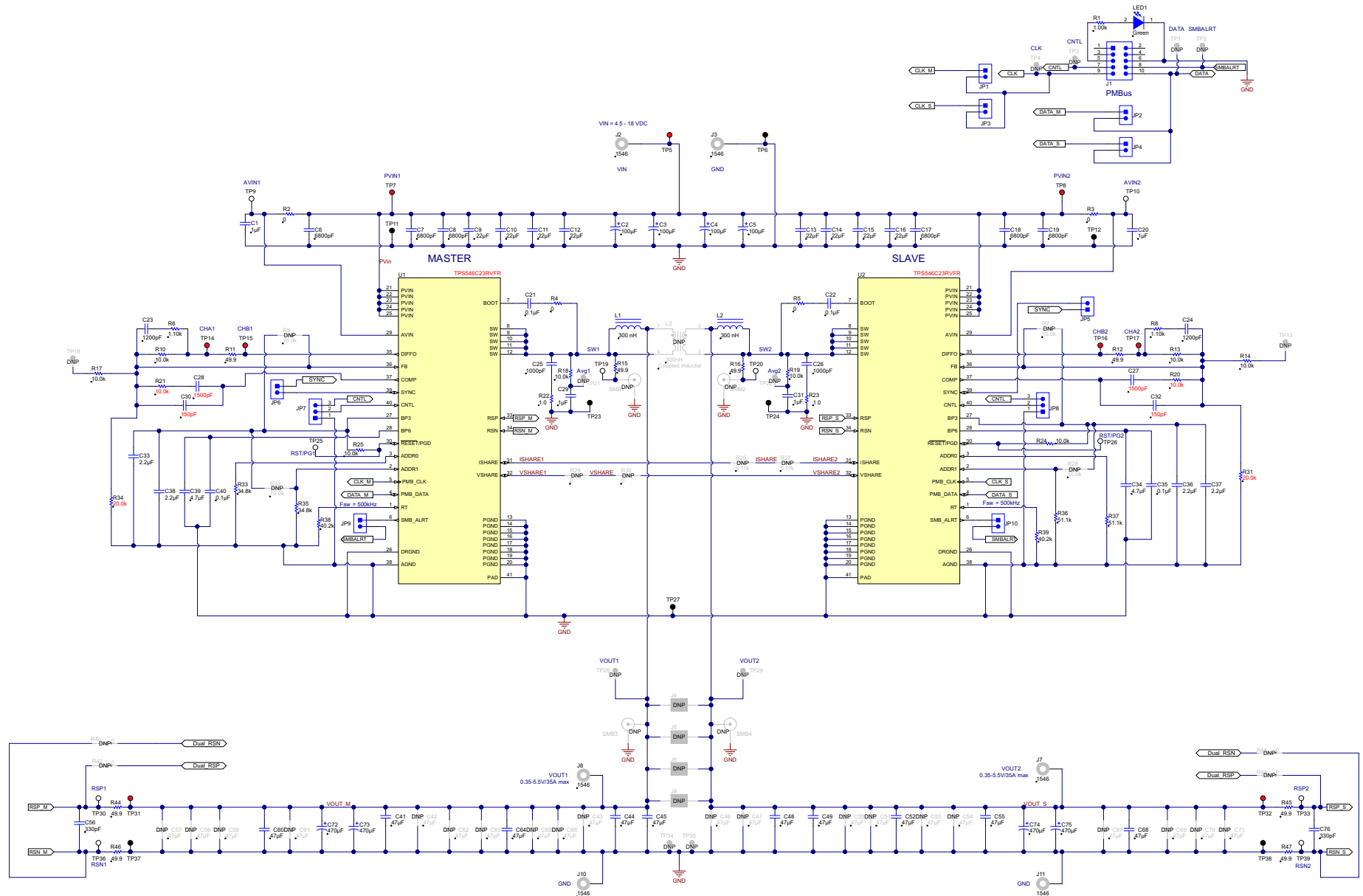

Figure 1. TPS546C23EV1-746 Schematic

4 Test Setup

4.1 Test and Configuration Software

In order to change any of the default configuration parameters on the EVM, it is necessary to obtain the TI Fusion Digital Power Designer software.

4.1.1 Description

The Fusion Digital Power Designer is the graphical user interface (GUI) used to configure and monitor the Texas Instruments TPS546C23 power converter installed on this evaluation module. The application uses the PMBus protocol to communicate with the controller over serial bus by way of a TI USB adapter. This adapter can be purchased at <http://www.ti.com/tool/usb-to-gpio>. (see).

4.1.2 Features

Some of the tasks you can perform with the GUI include:

- Turn on or off the power supply output, either through the hardware control line or the PMBus operation command.
- Monitor real-time data. Items such as output voltage, output current, die temperature, warnings and faults which are continuously monitored and displayed by the GUI.
- Configure common operating characteristics such as V_{OUT} trim and margin, UVLO, soft-start time, warning and fault thresholds, fault response, and ON/OFF modes.

This software is available for download at this location:

http://www.ti.com/tool/fusion_digital_power_designer

4.2 Test Equipment

4.2.1 Voltage Source

The input voltage source V_{IN} should be a 0-V to 20-V variable DC source capable of supplying 20 ADC. Connect input VIN and GND to J2 and J3 as shown in [Figure 2](#) and [Figure 3](#).

4.2.2 Multimeters

It is recommended to use two separate multi-meters as shown in [Figure 2](#) and [Figure 3](#). One meter to measure V_{IN} , the other to measure V_{OUT1} or V_{OUT2} . If both output is enabled at same time, three separate multi-meters are recommended.

4.2.3 Output Load:

A variable electronic load is recommended for the test setup as shown in [Figure 2](#) or [Figure 3](#). The load should be capable of 40 A.

4.2.4 Oscilloscope

An oscilloscope is recommended for measuring output noise and ripple. Output ripple should be measured using a *Tip-and-Barrel* method or better as shown in [Figure 4](#).

4.2.5 Fan:

During prolonged operation at high loads, it may be necessary to provide forced air cooling with a small fan aimed at the EVM. The temperature of the devices on the EVM should be maintained at less than 105°C.

4.2.6 USB-to-GPIO Interface Adapter:

A communications adapter is required between the EVM and the host computer. This EVM was designed to use the Texas Instruments USB-to-GPIO Adapter, see . This adapter can be purchased here: <http://www.ti.com/tool/usb-to-gpio>.

4.2.7 Recommended Wire Gauge

- Input VIN and GND to J2 and J3 (GND) (12-V input) – The recommended wire size is AWG #12, with the total length of wire less than 4 feet (2 feet input, 2 feet return).
- Output1 to J8 and J10 (GND) (0.9-V output) – The minimum recommended wire size is AWG #10, with the total length of wire less than 4 feet (2 feet OUTPUT, 2 feet return).
- Output2 to J7 and J11 (GND) (0.9-V output) – The minimum recommended wire size is AWG #10, with the total length of wire less than 4 feet (2 feet OUTPUT, 2 feet return).

4.3 Recommended Test Setup

Figure 2 and Figure 3 shows the recommended test setup.

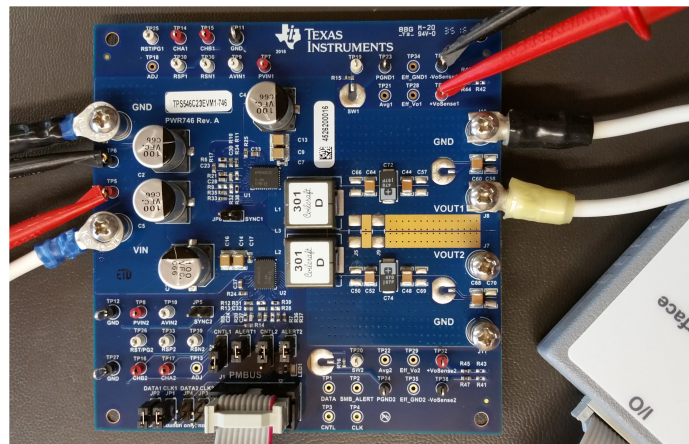

Figure 2. TPS546C23EVM1-746 EVM Recommended Test Set Up For Output #1

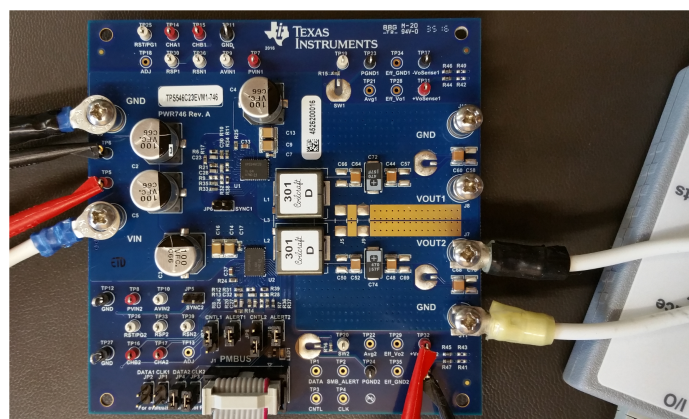

Figure 3. TPS546C23EVM1-746 EVM Recommended Test Set Up For Output #2

Figure 4 illustrates the tip and barrel measurement for switching node waveform on TP19 with TP23 or TP20 with TP24.

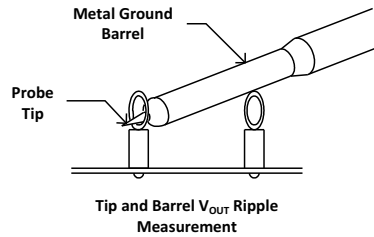

Figure 4. Tip and Barrel Measurement

4.4 List of Test Points, Jumpers and Connectors

Table 2 lists the test point functions.

Table 2. Test Point Functions

Test Point	Type	Name	Description
TP1	Not Assembled	DATA	DATA signal on J1 socket
TP2	Not Assembled	SMB_ALERT	SMBALERT signal on J1 socket
TP3	Not Assembled	CNTL	CNTL signal on J1 socket
TP4	Not Assembled	CLK	CLK signal on J1 socket
TP5	T-H Loop	VIN	V _{IN+} measurement point
TP6	T-H Loop	GND	V _{IN-} measurement point
TP7	T-H Loop	PVIN1	PVIN pin voltage of U1 device measurement point
TP8	T-H Loop	PVIN2	PVIN pin voltage of U2 device measurement point
TP9	T-H Loop	AVIN1	AVIN pin voltage of U1 device measurement point
TP10	T-H Loop	AVIN2	AVIN pin voltage of U2 device measurement point
TP11	T-H Loop	GND	GND reference
TP12	T-H Loop	GND	GND reference
TP13	Not Assembled	ADJ	Analog input to adjust rail 2 output voltage
TP14	T-H Loop	CHA1	Input for small signal loop gain measurements for output rail 1 (B/A setup)
TP15	T-H Loop	CHB1	OUTPUT for small signal loop gain measurements for output rail 1 (B/A setup)
TP16	T-H Loop	CHB2	OUTPUT for small signal loop gain measurements for output rail 2 (B/A setup)
TP17	T-H Loop	CHA2	Input for small signal loop gain measurements for output rail 2 (B/A setup)
TP18	Not Assembled	ADJ	Analog input to adjust rail 1 output voltage
TP19	T-H Loop	SW1	Switching node of output rail 1 measurement point, reference to TP23
TP20	T-H Loop	SW2	Switching node of output rail 2 measurement point, reference to TP24
TP21	Not Assembled	AVG1	Rail 1 switching node average voltage measurement point, reference to TP23
TP22	Not Assembled	AVG2	Rail 2 switching node average voltage measurement point, reference to TP24
TP23	T-H Loop	PGND1	GND reference for switching node measurement
TP24	T-H Loop	PGND2	GND reference for switching node measurement
TP25	T-H Loop	RST/RG1	PGOOD signal of output 1
TP26	T-H Loop	RST/PG2	PGOOD signal of output 2
TP27	T-H Loop	GND	GND reference
TP28	Not Assembled	EFF_VO1	Rail 1 output voltage measurement point for efficiency, reference to TP34
TP29	Not Assembled	EFF_VO2	Rail 2 output voltage measurement point for efficiency, reference to TP35
TP30	T-H Loop	RSP1	Output 1 remote sense + voltage point

Table 2. Test Point Functions (continued)

Test Point	Type	Name	Description
TP31	T-H Loop	+VOSENSE1	V_{OUT1+} measurement point
TP32	T-H Loop	+VOSENSE2	V_{OUT2+} measurement point
TP33	T-H Loop	RSP2	Output 2 remote sense + voltage point
TP34	Not Assembled	EFF_GND1	Rail 1 output voltage referencing GND for efficiency measurement
TP35	Not Assembled	EFF_GND2	Rail 1 output voltage referencing GND for efficiency measurement
TP36	T-H Loop	RSN1	Output 1 remote sense - voltage point
TP37	T-H Loop	-VOSENSE1	V_{OUT1-} measurement point
TP38	T-H Loop	-VOSENSE2	V_{OUT2-} measurement point
TP39	T-H Loop	RSN2	Output 2 remote sense - voltage point

Table 3 lists the EVM jumpers.

Table 3. Jumpers

Jumper	Type	Name	Description
JP1	Header, 100mil, 2x1	CLK1	PMBUS CLK connection between U1 and socket J1. Jumper is plugged as default.
JP2	Header, 100mil, 2x1	DATA1	PMBUS DATA connection between U1 and socket J1. Jumper is plugged as default.
JP3	Header, 100mil, 2x1	CLK2	PMBUS CLK connection between U2 and socket J1. Jumper is plugged as default.
JP4	Header, 100mil, 2x1	DATA2	PMBUS DATA connection between U2 and socket J1. Jumper is plugged as default.
JP5	Header, 100mil, 2x1	SYNC2	Synchronization connection between U1 and U2. Jumper is NOT plugged as default.
JP6	Header, 100mil, 2x1	SYNC1	Synchronization connection between U1 and U2. Jumper is NOT plugged as default.
JP7	Header, 100mil, 3x1	CNTL1	PMBUS CNTL connection options for U1 to socket J1 or GND. Jumper connecting U1 to J1 is plugged as default.
JP8	Header, 100mil, 3x1	CNTL2	PMBUS CNTL connection options for U2 to socket J1 or GND. Jumper connecting U1 to J1 is plugged as default.
JP9	Header, 100mil, 2x1	ALERT1	PMBUS SMBALERT connection between U1 and socket J1. Jumper is plugged as default.
JP10	Header, 100mil, 2x1	ALERT2	PMBUS SMBALERT connection between U2 and socket J1. Jumper is plugged as default.

Table 4 lists the EVM connector functions.

Table 4. Connector Functions

Connector	Type	Name	Description
J1	Header, 100mil, 5x2	PMBUS	PMBUS socket for TI FUSION adaptor
J2	Keystone 1546	VIN	VIN+ connector
J3	Keystone 1546	GND	VIN- (GND) connector
J8	Keystone 1546	VOUT1	VOUT1+ connector
J10	Keystone 1546	GND	VOUT1- connector
J7	Keystone 1546	VOUT2	VOUT2+ connector
J11	Keystone 1546	GND	VOUT2- connector

5 EVM Configuration Using the Fusion GUI

The TPS546C23 on this EVM leave the factory pre-configured. See [Table 5](#) for a short list of key factory configuration parameters as obtained from the configuration file.

Table 5. Key Factory Configuration Parameters

ADDRESS HEX	ADDRESS DEC	PART ID	DESIGNATOR		
0x33	27	TPS546C23	U1		
0x44	36	TPS546C23	U2		
GENERAL					
CMD Code	CMD CODE HEX	ENCODED HEX	DECODED		COMMENTS
VIN_OFF	0x36	0xF010	4.0 V		Turn OFF voltage
VIN_ON	0x35	0xF012	4.5 V		Turn ON voltage
IOUT_CAL_OFFSET	0x39	0xE000	0.0000 A		Current offset for PMBUS readout
IOUT_OC_FAULT_LIMIT	0x46	0xF854	42 A		OC fault level
IOUT_OC_FAULT_RESPONSE	0x47	0xFF	Restart		Response to OC fault
IOUT_OC_WARN_LIMIT	0x4A	0xF84A	37 A		OC warning level
VOUT_COMMAND	0x21	0x0133	0.6 V		Reference voltage
VOUT_MIN	0x2B	00B3h	0.35V		minimum reference voltage
VOUT_MAX	0x24	0x034D	1.65 V		maximum reference voltage
VOUT_TRANSITION_RATE	0x27	0xD03C	1 mV/us		Vout transition rate
VOUT_SCALE_LOOP	0x29	0xF004	1		Output sense scaling ratio for main control loop
PCT_OV_UV_WRN_FLT_LIMITS	0xD6	0x00	UV FAULT	83%	Output OV/UV Settings, reference to nominal reference voltage.
			UV WARN	88%	
			OV WARN	112%	
			OV FAULT	117%	
VOUT_OV_FAULT_RESPONSE	0x41	0xBF	Restart		Output overvoltage fault response
VOUT_UV_FAULT_RESPONSE	0x45	0xBF	Restart		Output undervoltage fault response
ON_OFF_CONFIG	0x02	0x16	CNTL only, Active High.		Control signal and operation command
OPERATION	0x01	0x00	Operation is not used to enable regulation		Can be used to control device On/Off
OT_FAULT_LIMIT	0x4F	0x0091	145°C		OT fault level
OT_WARN_LIMIT	0x51	0x0078	120°C		OT warn level
OT_FAULT_RESPONSE	0x50	0x3F	Ignore		Response to over temperature faults
TON_DELAY	0x60	0x0000	0 ms		Turn-on delay
TON_RISE	0x61	0x0003	3 ms		Soft-start time
TON_MAX_FAULT_LIMIT	0x62	0x0000	Disabled		Upper limit for Vout reaching regulation
TOFF_DELAY	0x64	0x0000	0 ms		Turn-off delay
TOFF_FALL	0x65	0x0000	0 ms		Soft-stop fall time

If it is desired to configure the EVM to settings other than the factory settings shown above, the TI Fusion Digital Power Designer software can be used for reconfiguration. It is necessary to have input voltage applied to the EVM prior to launching the software so that the TPS546C23 may respond to the GUI and the GUI can recognize the device. The default configuration for the EVM is to start converting at an input voltage of 4.5V, therefore to avoid any converter activity during configuration, an input voltage less than 4.5 V should be applied. An input voltage of 4 V is recommended.

5.1 Configuration Procedure

1. Adjust the input supply to provide 4 VDC, current limited to 1 A.
2. Apply the input voltage to the EVM. Refer to [Figure 2](#) and [Figure 3](#) for connections and test setup.
3. Launch the Fusion GUI software. Refer to the screenshots in [Section 10](#) for more information.
4. Configure the EVM operating parameters as desired.

By default, both TPS546C23 is configured as loop master, PMBUS address for U1 is 27 decimal and for U2 is 36 decimal.

Both device can be enabled to operate simultaneously, and also both device can be tied to PMBUS interface simultaneously.

To configure or monitor device U1, JP1, JP2 and JP9 should be plugged; to configure or monitor device U2, JP3, JP4 and JP10 should be plugged in.

With all these jumpers plugged in, two device can be configured or monitored at different address simultaneously.

6 Test Procedure

6.1 Line and Load Regulation and Efficiency Measurement Procedure

1. Set up the EVM as described in [Figure 2](#).
2. Ensure the electronic loads is set to draw 0 Adc.
3. Increase V_{IN} from 0 V to 12 V using voltage meter to measure input voltage.
4. Use the other voltage meter to measure output voltage V_{OUT1} .
5. Vary the load from 0 to 35 Adc. V_{OUT1} should remain in regulation as defined in [Table 1](#).
6. Vary V_{IN} from 5 V to 18 V. V_{OUT1} should remain in regulation as defined in [Table 1](#).
7. Decrease the load to 0 A.
8. Decrease V_{IN} to 0 V.
9. Set up the EVM as described in [Figure 3](#)
10. Increase V_{IN} from 0 V to 12 V using voltage meter to measure input voltage.
11. Use voltage meter to measure output voltage V_{OUT2} .
12. Vary the load from 0 to 35 Adc. V_{OUT2} should remain in regulation as defined in [Table 1](#).
13. Vary V_{IN} from 5 V to 18 V. V_{OUT2} should remain in regulation as defined in [Table 1](#).
14. Decrease the load to 0 A.
15. Decrease V_{IN} to 0 V.

6.2 Control Loop Gain and Phase Measurement Procedure

The TPS546C23EVM1-746 EVM includes a 49.9- Ω series resistor in the feedback loop for both V_{OUT1} and V_{OUT2} . These resistors are used for loop response analysis, and are accessible at the test points TP14 / TP15 for V_{OUT1} , and TP16 / TP17 for V_{OUT2} . Those test points should be used during loop response measurements as the injection points for the loop perturbation. See the description in [Table 6](#).

Table 6. List of Test Points for Loop Response Measurements

Test Point	Node Name	Description	Comment
TP14	CHA1	Input to feedback divider of V_{OUT1}	The amplitude of the perturbation at this node should be limited to less than 30 mV
TP15	CHB1	Resulting output of V_{OUT1}	Bode can be measured by a network analyzer with a CH-B/CH-A configuration
TP17	CHA2	Input to feedback divider of V_{OUT2}	The amplitude of the perturbation at this node should be limited to less than 30 mV
TP16	CHB2	Resulting output of V_{OUT2}	Bode can be measured by a network analyzer with a CH-B/CH-A configuration

Measure only one output at a time, with the following procedure:

1. Set up the EVM as described in [Figure 2](#).
2. For V_{OUT1} , connect the network analyzer's isolation transformer from TP14 to TP15,
3. Connect the input signal measurement probe to TP14. Connect the output signal measurement probe to TP15.
4. Connect the ground leads of both probe channels to TP11.
5. On the network analyzer, measure the Bode as TP15/TP14 (Out/In).
6. Set up the EVM as described in [Figure 3](#)
7. For V_{OUT2} , connect the network analyzer's isolation transformer from TP17 to TP16.
8. Connect the input signal measurement probe to TP17. Connect output signal measurement probe to TP16.
9. Connect the ground leads of both probe channels to TP12.
10. On the network analyzer, measure the Bode as TP16/TP17 (Out/In).

6.3 Efficiency Measurement

In order to evaluate the efficiency of the power train (device and inductor), it is important to measure the voltages at the correct location. This is necessary because otherwise the measurements will include losses that are not related to the power train itself. Losses incurred by the voltage drop in the copper traces and in the input and output connectors are not related to the efficiency of the power train, and they should not be included in efficiency measurements.

When measuring the efficiency of V_{OUT1} , disable V_{OUT2} through Jumper JP8 (Figure 2). Likewise, when measuring the efficiency of V_{OUT2} , disable V_{OUT1} through Jumper JP7 (Figure 3).

Input current can be measured at any point in the input wires, and output current can be measured anywhere in the output wires of the output being measured.

Table 7 shows the measurement points for input voltage and output voltage. VIN1 and VOUT1 are measured to calculate the efficiency of U1 rail; VIN2 and VOUT2 are measured to calculate the efficiency U2 rail. Using these measurement points will result in efficiency measurements that excluded losses due to the connectors and PCB traces.

Table 7. Test Points for Better Efficiency Measurements

Test Point	Node Name	Description	Comment
VOUT1			
TP7	PVIN1	Input voltage measurement point for VIN1+	The pair of test points are connected to the PVIN/GND pins of U1. The voltage drop between input terminal to the device pins is excluded for efficiency measurement.
TP23	PGND1	Input voltage measurement point for VIN1- (GND)	
TP28	Eff_Vo1	Output voltage measurement point for VOUT1+	The pair of test points are connected to the closest points of Vout /GND to the inductor. The voltage drop from the output point of inductor to the output terminals is excluded for efficiency measurement.
TP34	Eff_GND1	Output voltage measurement point for VOUT1- (GND)	
VOUT2			
TP8	PVIN2	Input voltage measurement point for VIN2+	The pair of test points are connected to the PVIN/GND pins of U2 . The voltage drop between input terminal to the device pins is excluded for efficiency measurement.
TP24	PGND2	Input voltage measurement point for VIN2- (GND)	
TP29	Eff_Vo2	Output voltage measurement point for VOUT2+	The pair of test points are connected to the closest points of Vout /GND to the inductor. The voltage drop from the output point of inductor to the output terminals is excluded for efficiency measurement.
TP35	Eff_GND2	Output voltage measurement point for VOUT2- (GND)	

7 Performance Data and Typical Characteristic Curves

Figure 5 through Figure 18 present typical performance curves for the TPS546C23EVM1-746 .

7.1 Efficiency

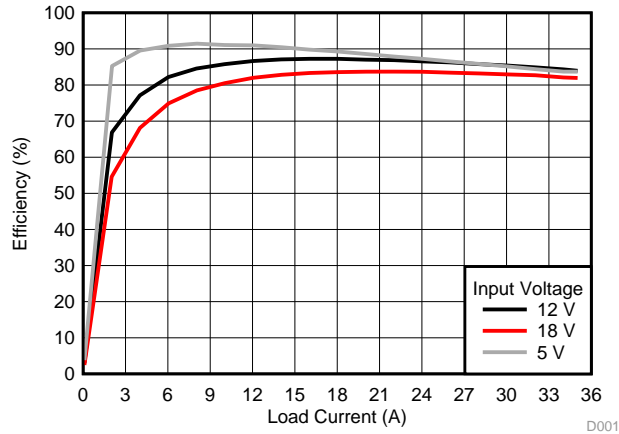

Figure 5. Efficiency of 0.9-V Output vs Line and Load

7.2 Load Regulation

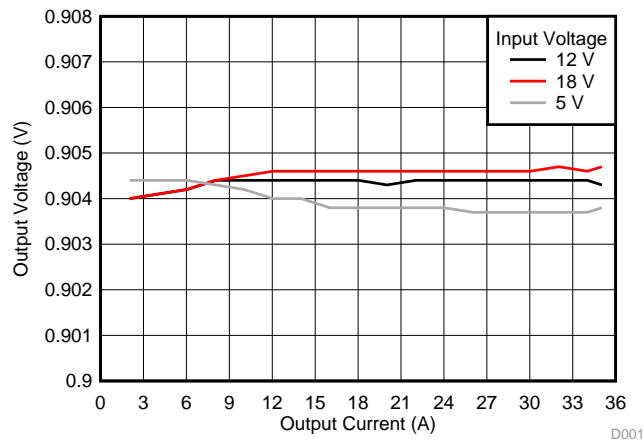

Figure 6. Load Regulation of 0.9-V Output

7.3 Line Regulation

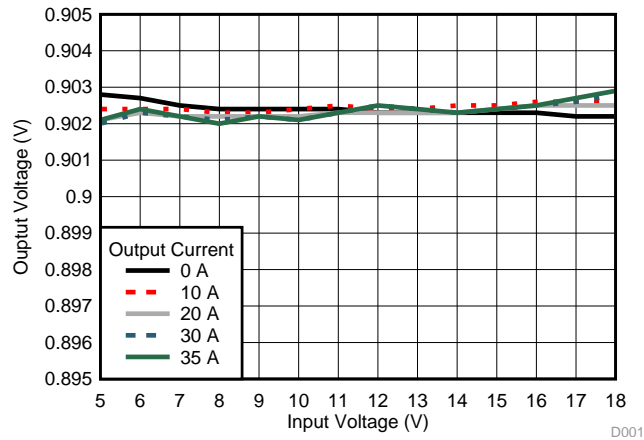
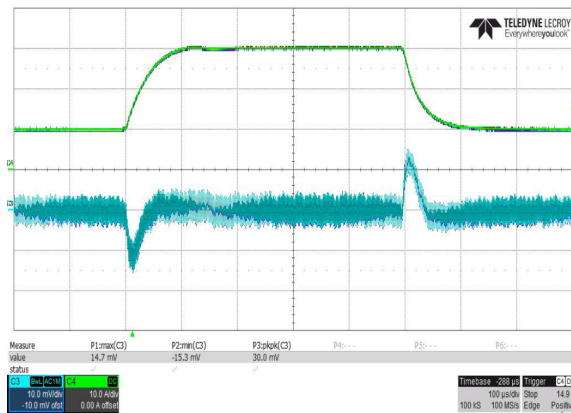

Figure 7. Line Regulation of 0.9-V Output (Different Board)

7.4 Transient Response



Ch3 = V_{OUT} at 10 mV/division, Ch4 = I_{OUT} at 10 A/division

Figure 8. Transient Response of 0.9-V Output at 12 V_{IN}, Transient is 10 A to 30 A, 0.2 A/μs

7.5 Output Ripple

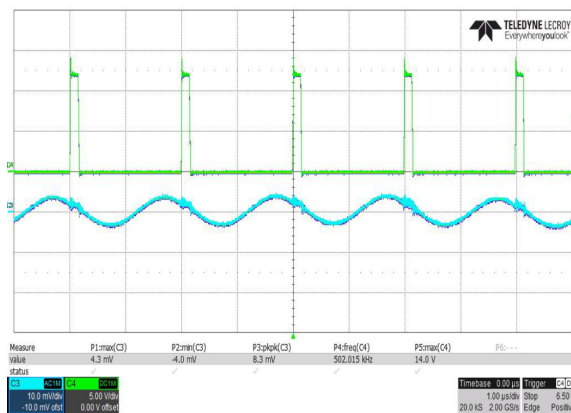

Ch3 = V_{OUT} ripple at 10 mV/division, Ch4 = SW at 5 V/division,

Figure 9. Output Ripple and SW Node of 0.9-V Output at 12 V_{IN}, 0-A Output

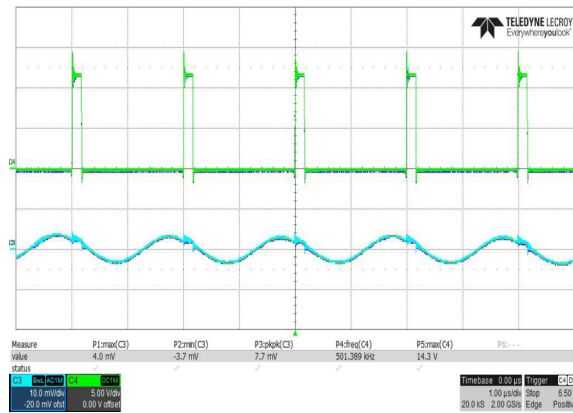

Ch3 = V_{OUT} ripple at 10 mV/division, Ch4 = SW at 5 V/division,

Figure 10. Output Ripple and SW Node of 0.9-V Output at 12 V_{IN}, 35-A Output

7.6 Control On

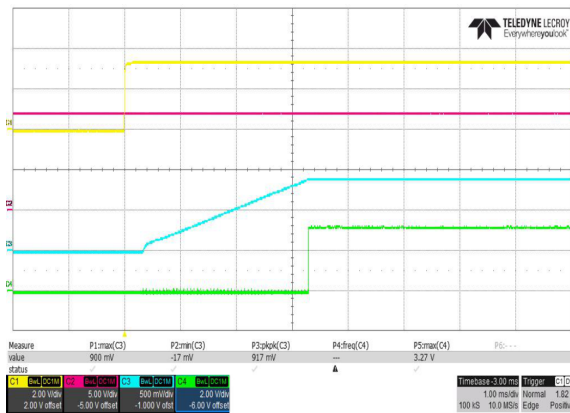

Ch1 = CNTL at 2 V/division, Ch2 = VIN at 5 V/division, Ch3 = VOUT at 500 mV/division, Ch4 = PGOOD at 2 V/division

Figure 11. Start up from Control, 0.9-V Output at 12 V_{IN}, 0-A Output

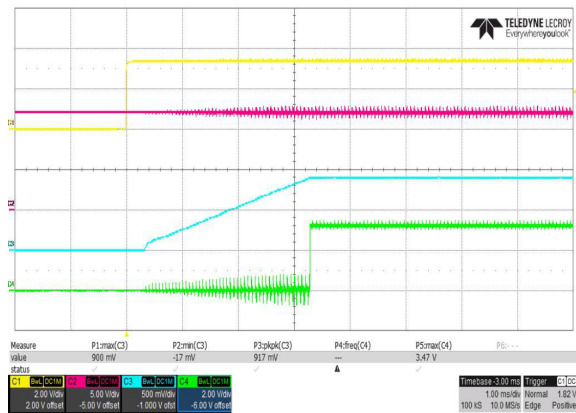

Ch1 = CNTL at 2 V/division, Ch2 = VIN at 5 V/division, Ch3 = VOUT at 500 mV/division, Ch4 = PGOOD at 2 V/division

Figure 12. Start up from Control, 0.9-V Output at 12 V_{IN}, 35-A Output

7.7 Control Off

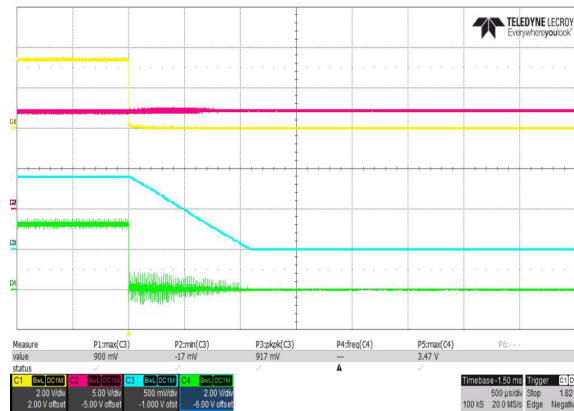

Ch1 = V_{IN} at 10 V/division, Ch2 = CNTL at 2 V/division, Ch3 = V_{OUT} at 500 mV/division, Ch4 = PGOOD at 5 V/division

Figure 13. Soft Stop from Control, 0.9-V Output at 12 V_{IN} , 35-A Output

7.8 Control On under Pre-bias

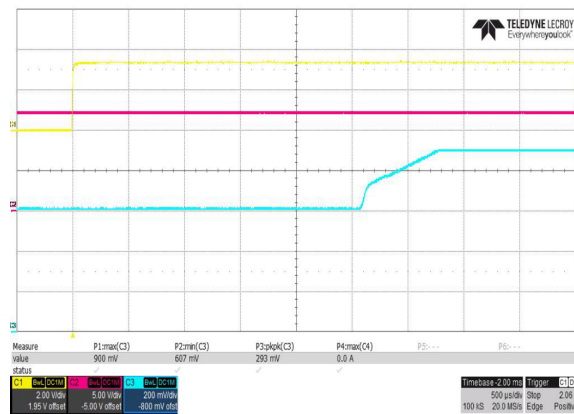

Ch1 = CNTL at 2 V/division, Ch2 = V_{IN} at 5 V/division, Ch3 = V_{OUT} at 200 mV/division

Figure 14. 0.6-V Pre-bias start up from Control, 0.9-V Output at 12 V_{IN} , 0-A Output

7.9 Overcurrent Protection



Ch2 = V_{IN} at 5 V/division, Ch3 = V_{OUT} at 500 mV/division, Ch4 = I_{OUT} at 10 A/division

Figure 15. Overcurrent Protection, 0.9-V Output at 12 V_{IN} , 35-A Output (OC_Fault threshold is modified to 35A)

7.10 Control Loop Bode Plot

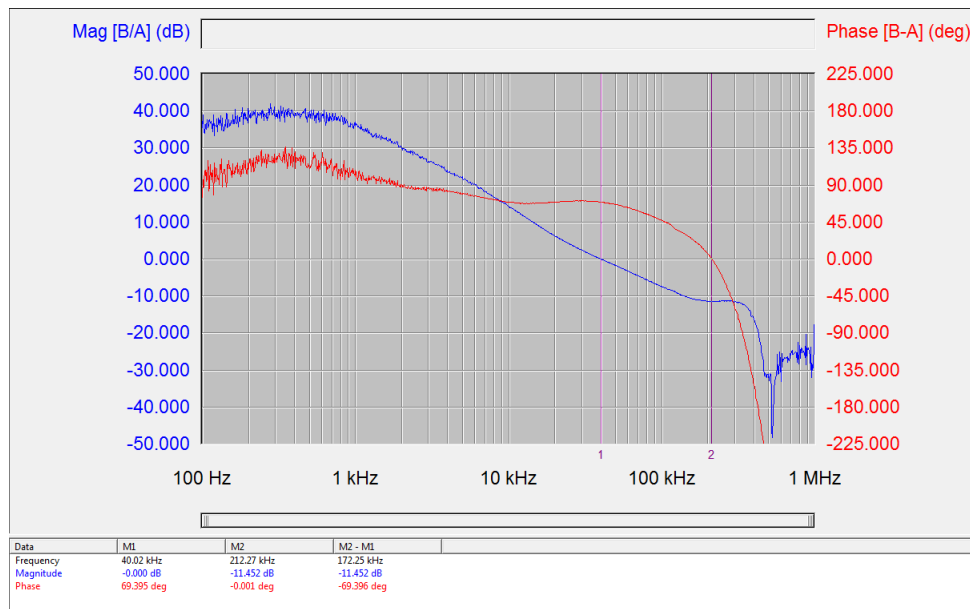

Figure 16. Bode Plot at 0.9-V Output at 12 V_{IN} , 0-A Output

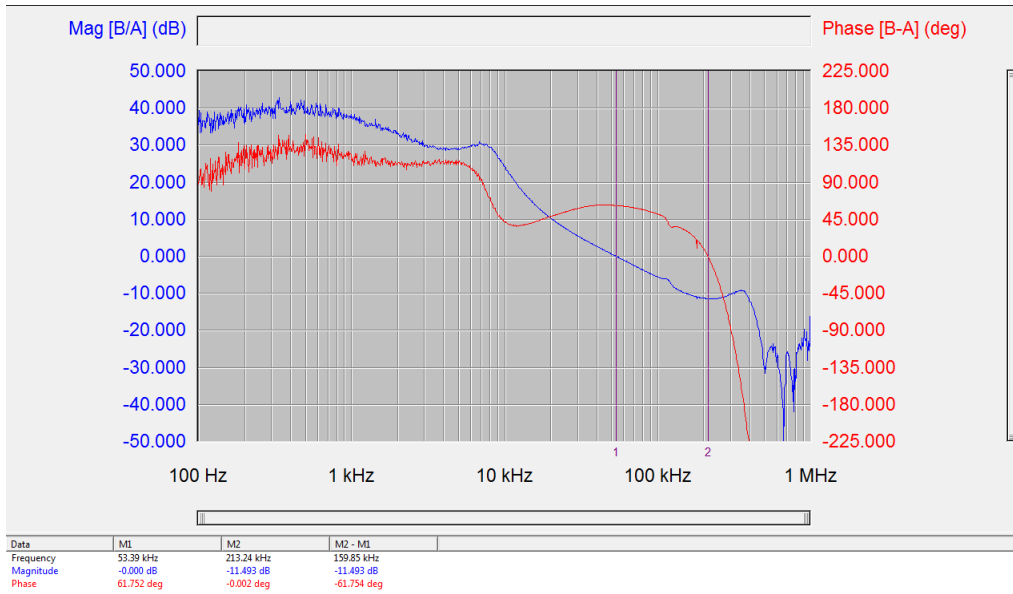
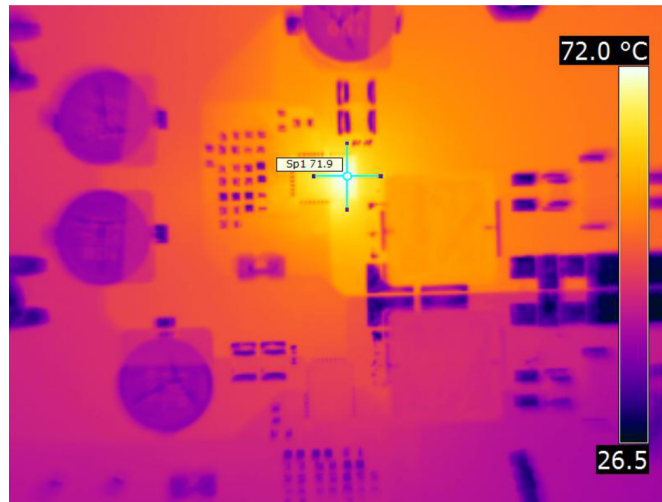

Figure 17. Bode Plot at 0.9-V Output at 12 V_{IN}, 35-A Output

7.11 Thermal Image



$V_{IN} = 12\text{ V}$, $I_{OUT1} = 35\text{ A}$, $V_{OUT1} = 0.9\text{ V}$, $F_{SW} = 500\text{ kHz}$

Figure 18. Thermal Image

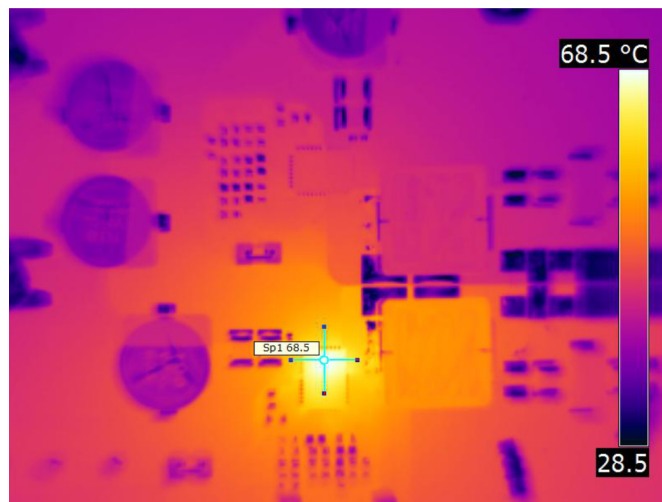

$V_{IN} = 12\text{ V}$, $I_{OUT2} = 0\text{ A}$, $V_{OUT2} = 0.9\text{ V}$, $F_{SW} = 500\text{ kHz}$

Figure 19. Thermal Image

8 EVM Assembly Drawing and PCB Layout

Figure 20 through Figure 28 show the design of the TPS546C23EVM1-746 EVM printed circuit board.

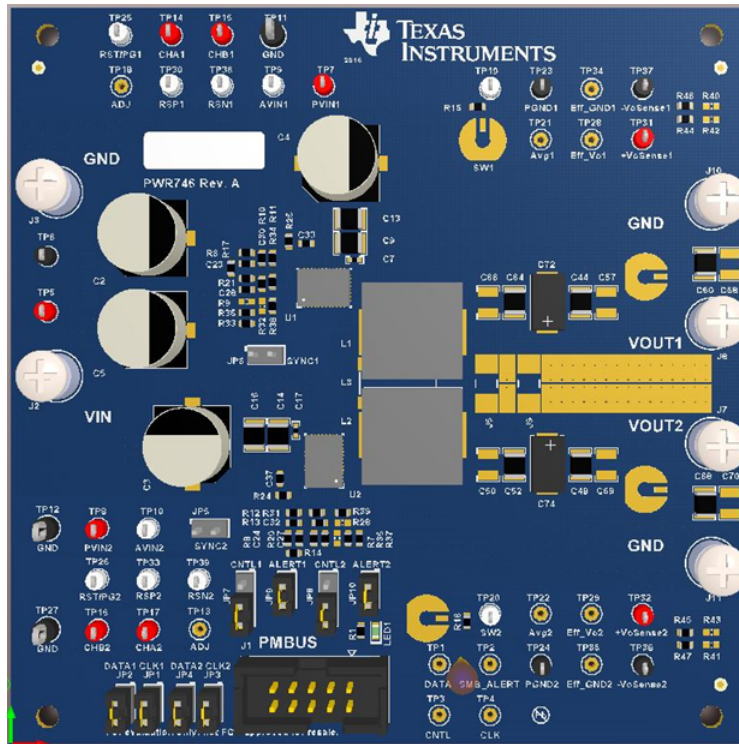

Figure 20. TPS546C23EVM1-746 EVM 3D Top View

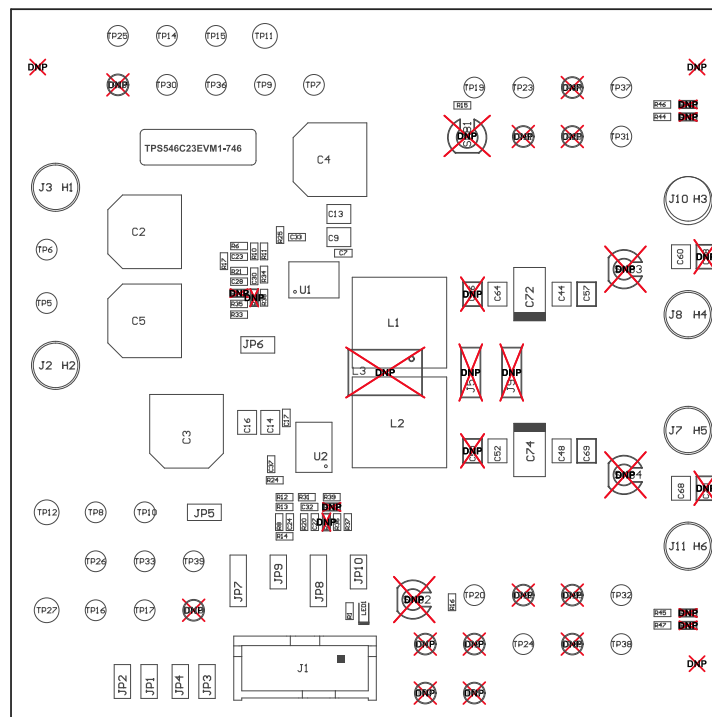

Figure 21. TPS546C23EVM1-746 EVM Top Layer Assembly Drawing (Top View)

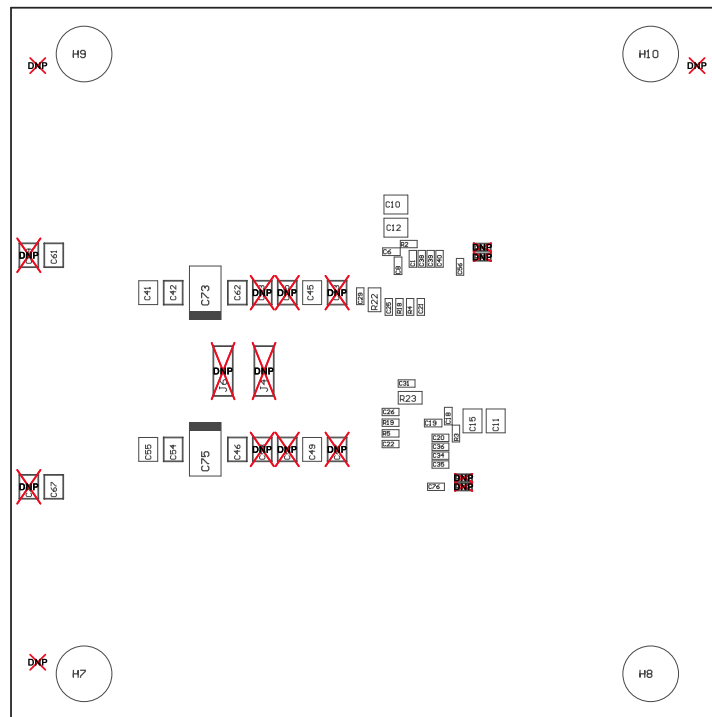

Figure 22. TPS546C23EVM1-746 EVM Bottom Assembly Drawing (Bottom View)

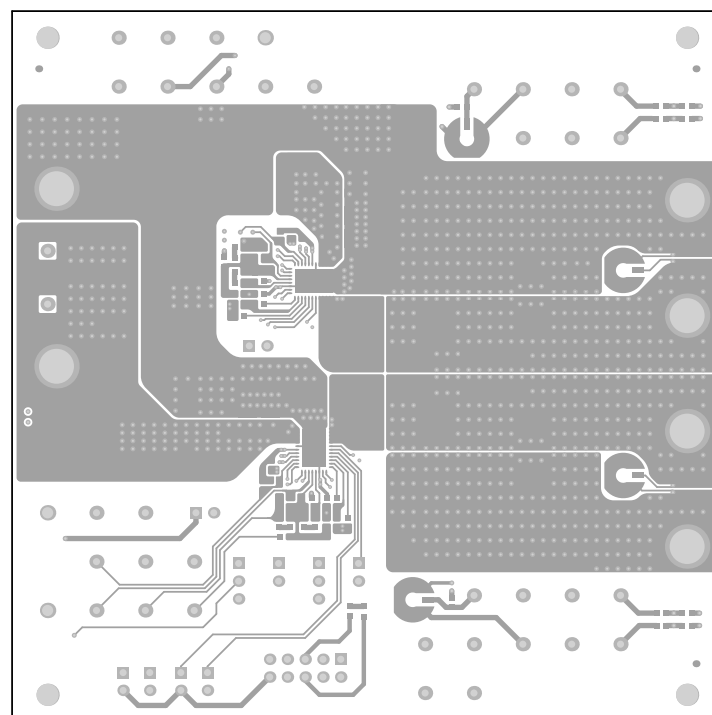

Figure 23. TPS546C23EVM1-746 EVM Top Copper (Top View)

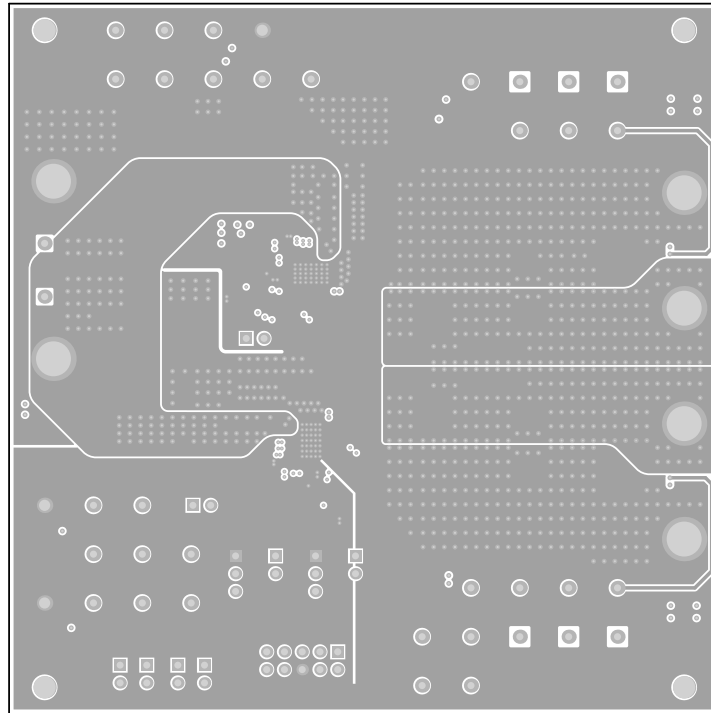

Figure 24. TPS546C23EVM1-746 EVM Internal Layer 1 (Top View)

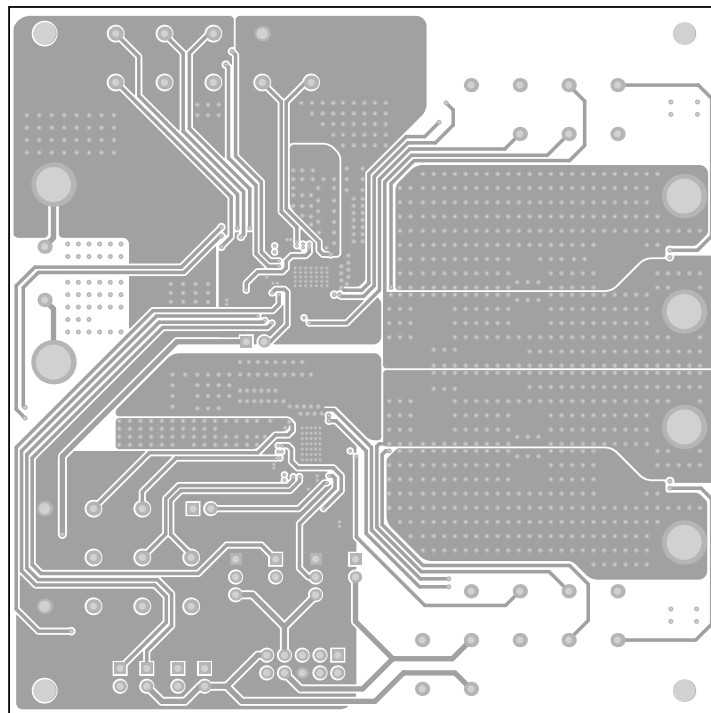

Figure 25. TPS546C23EVM1-746 EVM Internal Layer 2 (Top View)

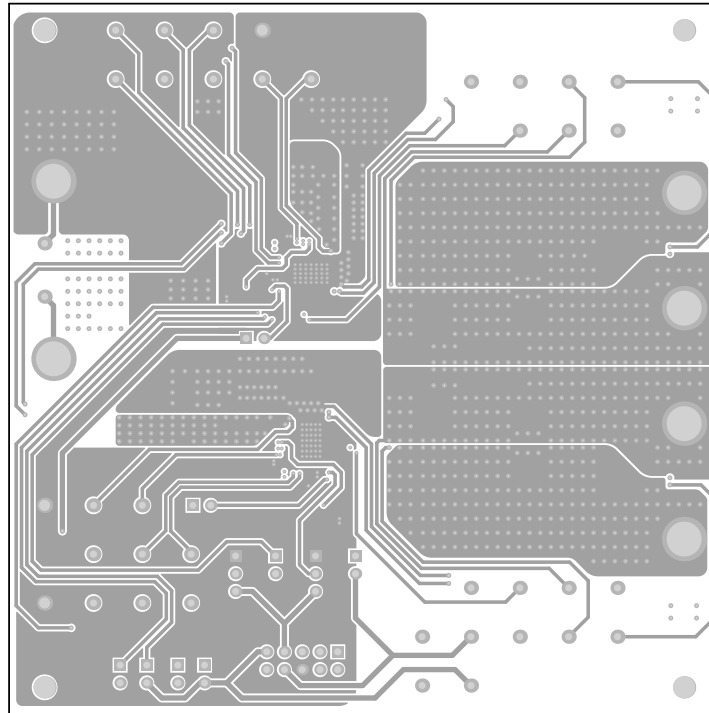

Figure 26. TPS546C23EVM1-746 EVM Internal Layer 3 (Top View)

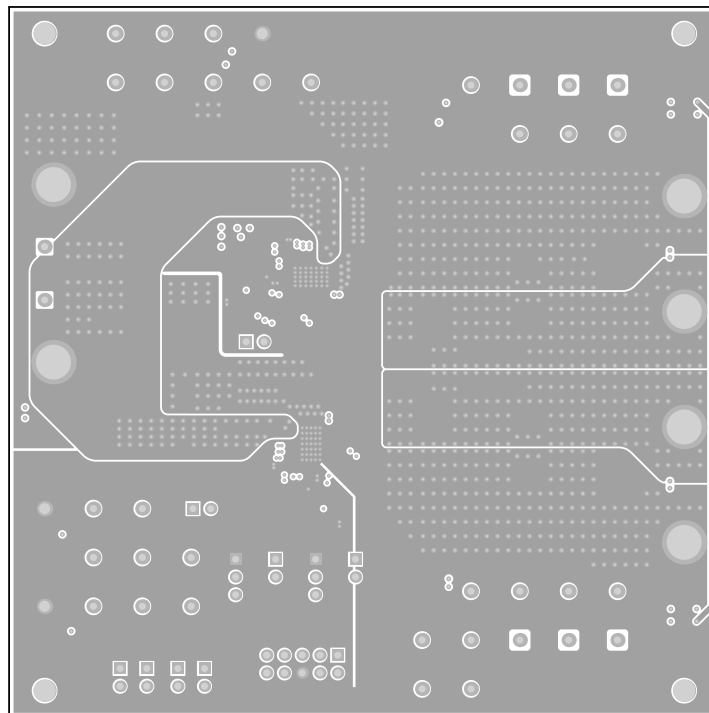

Figure 27. TPS546C23EVM1-746 EVM Internal Layer 4 (Top View)

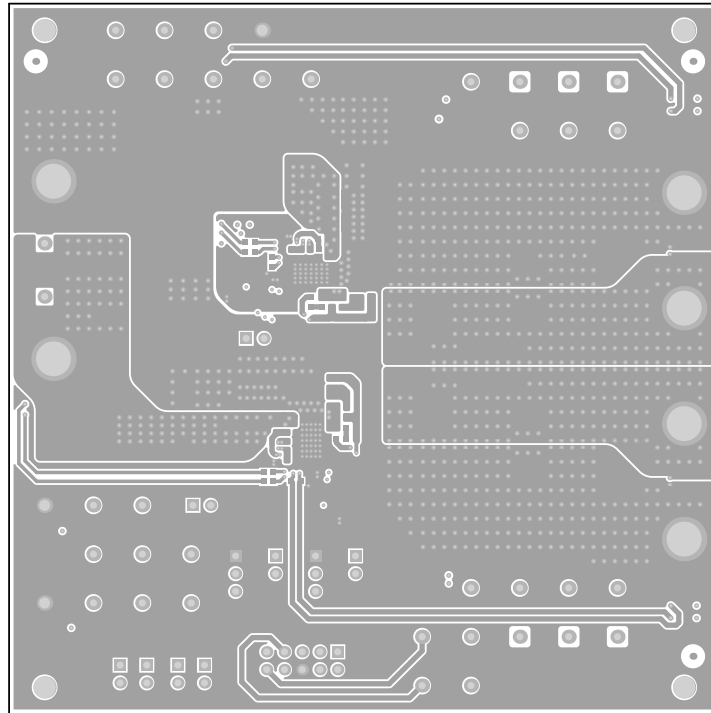

Figure 28. TPS546C23EVM1-746 EVM Bottom Copper (Top View)

9 Bill of Materials

Table 8 lists the BOM for the TPS546C23EVM1-746 (TPS546C23 EVM).

Table 8. TPS546C23EVM1-746 Components List

Qty	Designator	Description	Part Number	Manufacturer
4	C1, C20, C29, C31	CAP, CERM, 1 µF, 25 V, +/- 10%, X7R, 0603	GRM188R71E105KA12D	MuRata
4	C2, C3, C4, C5	CAP, AL, 100 µF, 35 V, +/- 20%, 0.15 ohm, SMD	EEE-FC1V101P	Panasonic
6	C6, C7, C8, C17, C18, C19	CAP, CERM, 6800 pF, 50 V, +/- 10%, X7R, 0402	GRM155R71H682KA88D	MuRata
8	C9, C10, C11, C12, C13, C14, C15, C16	CAP, CERM, 22 µF, 25 V, +/- 10%, X6S, 1210	GRM32EC81E226KE15L	MuRata
2	C21, C22	CAP, CERM, 0.1 µF, 50 V, +/- 10%, X7R, 0603	C0603C104K5RACTU	Kemet
2	C23, C24	CAP, CERM, 1200 pF, 100 V, +/- 5%, C0G/NP0, 0603	GRM1885C2A122JA01D	MuRata
2	C25, C26	CAP, CERM, 1000 pF, 100 V, +/- 5%, X7R, 0603	06031C102JAT2A	AVX
2	C27, C28	CAP, CERM, 1500 pF, 50 V, +/- 5%, C0G/NP0, 0603	GRM1885C1H152JA01D	MuRata
2	C30, C32	CAP, CERM, 150 pF, 50 V, +/- 5%, C0G/NP0, 0603	GRM1885C1H151JA01D	MuRata
4	C33, C36, C37, C38	CAP, CERM, 2.2 µF, 16 V, +/- 10%, X7R, 0603	GRM188Z71C225KE43	MuRata
2	C34, C39	CAP, CERM, 4.7 µF, 10 V, +/- 10%, X5R, 0603	C0603C475K8PACTU	Kemet
2	C35, C40	CAP, CERM, 0.1 µF, 16 V, +/- 10%, X7R, 0603	C0603C104K4RACTU	Kemet
10	C41, C44, C45, C48, C49, C52, C55, C60, C64, C68	CAP, CERM, 47 µF, 10 V, +/- 10%, X7R, 1210	GRM32ER71A476KE15L	MuRata
2	C56, C76	CAP, CERM, 330 pF, 50 V, +/- 1%, C0G/NP0, 0603	C1608C0G1H331F080AA	TDK
4	C72, C73, C74, C75	CAP, Tantalum Polymer, 470 µF, 6.3 V, +/- 20%, 0.01 ohm, 7343-40 SMD	6TPF470MAH	Panasonic
6	H1, H2, H3, H4, H5, H6	MACHINE SCREW PAN PHILLIPS 6-32	PMSSS 632 0038 PH	B&F Fastener Supply
4	H7, H8, H9, H10	Bumpon, Cylindrical, 0.312 X 0.200, Black	SJ61A1	3M
1	J1	Header (shrouded), 100mil, 5x2, Gold, TH	5103308-1	TE Connectivity
6	J2, J3, J7, J8, J10, J11	Swage Threaded Standoff, Brass, Swage Mount, TH	1546	Keystone
8	JP1, JP2, JP3, JP4, JP5, JP6, JP9, JP10	Header, 100mil, 2x1, Tin, TH	5-146278-2	TE Connectivity
2	JP7, JP8	Header, 100mil, 3x1, Tin, TH	5-146278-3	TE Connectivity
2	L1, L2	Inductor, Shielded, Ferrite, 300 nH, 52 A, 0.00015 ohm, SMD	SLC1480-301MLB	Coilcraft
1	LBL1	Thermal Transfer Printable Labels, 0.650" W x 0.200" H - 10,000 per roll	THT-14-423-10	Brady
1	LED1	LED, Green, SMD	150060GS75000	Wurth Elektronik
1	R1	RES, 1.00 k, 1%, 0.1 W, 0603	CRCW06031K00FKEA	Vishay-Dale
4	R2, R3, R4, R5	RES, 0, 5%, 0.1 W, 0603	ERJ-3GEY0R00V	Panasonic
2	R6, R8	RES, 1.10 k, 1%, 0.1 W, 0603	RC0603FR-071K1L	Yageo America
2	R10, R13	RES, 10.0 k, 0.1%, 0.1 W, 0603	RT0603BRD0710KL	Yageo America
8	R11, R12, R15, R16, R44, R45, R46, R47	RES, 49.9, 1%, 0.1 W, 0603	CRCW060349R9FKEA	Vishay-Dale
8	R14, R17, R18, R19, R20, R21, R24, R25	RES, 10.0 k, 1%, 0.1 W, 0603	RC0603FR-0710KL	Yageo America
2	R22, R23	RES, 1.0, 5%, 0.25 W, 1206	CRCW12061R00JNEA	Vishay-Dale
2	R31, R34	RES, 10.0 k, 1%, 0.1 W, 0603	RC0603FR-0710KL	Yageo America
2	R33, R35	RES, 34.8 k, 1%, 0.1 W, 0603	RC0603FR-0734K8L	Yageo America
2	R36, R37	RES, 51.1 k, 1%, 0.1 W, 0603	RC0603FR-0751K1L	Yageo America
2	R38, R39	RES, 40.2 k, 1%, 0.1 W, 0603	CRCW060340K2FKEA	Vishay-Dale
6	SH-JP1, SH-JP2, SH-JP7, SH-JP8, SH-JP9, SH-JP10	Shunt, 100mil, Gold plated, Black	969102-0000-DA	3M
1	TP5	Test Point, Miniature, Red, TH	5000	Keystone
3	TP6, TP23, TP24	Test Point, Miniature, Black, TH	5001	Keystone
8	TP7, TP8, TP14, TP15, TP16, TP17, TP31, TP32	Test Point, Miniature, Red, TH	5000	Keystone
10	TP9, TP10, TP19, TP20, TP25, TP26, TP30, TP33, TP36, TP39	Test Point, Miniature, White, TH	5002	Keystone

Table 8. TPS546C23EVM1-746 Components List (continued)

Qty	Designator	Description	Part Number	Manufacturer
3	TP11, TP12, TP27	Test Point, Multipurpose, Black, TH	5011	Keystone
2	TP37, TP38	Test Point, Miniature, Black, TH	5001	Keystone
2	U1, U2	4.5V-18V, 35A PMBUS STACKABLE SYNCHRONOUS BUCK CONVERTER, RVF0040A	TPS546C23	Texas Instruments

10 Screenshots

10.1 Fusion GUI Screenshots

When launching the Fusion GUI, select **IC_DEVICE_ID** in [Figure 29](#) as scanning mode to find TPS546C23.

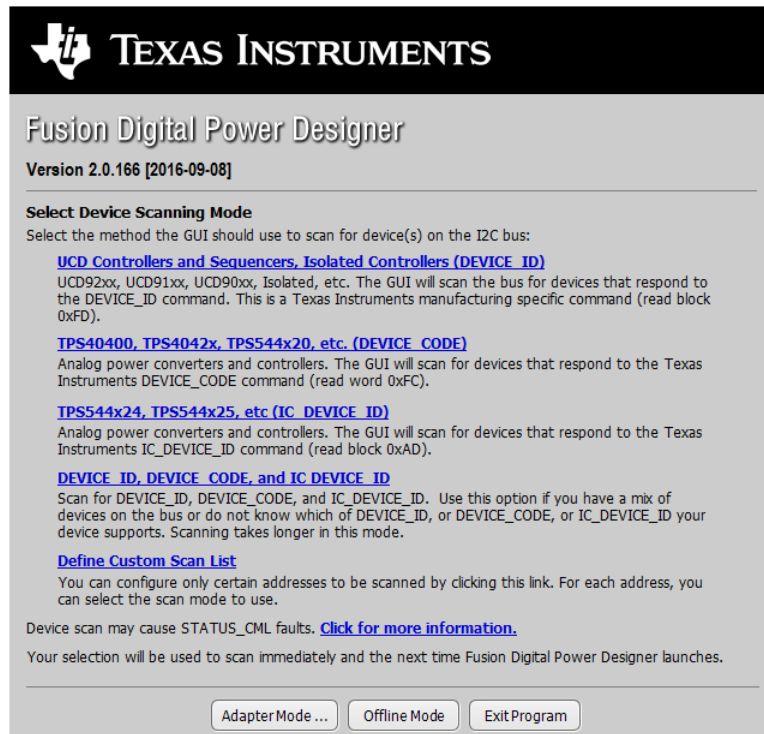

Figure 29. Select Device Scanning Mode

- Use the **Limits & On/Off** tab [Figure 30](#) to configure the following:
 - V_{ref} (Vout_Command)
 - OC Fault and OC Warn
 - OT Fault and OT Warn (Die Temperature)
 - Power Good Limits
 - Fault response
 - UVLO
 - On/Off Config
 - Soft Start time (Turn On Rise)
 - Margin voltage

After making changes to one or more configurable parameters, the changes can be committed to nonvolatile memory by clicking **Store DefaultAll**. This action prompts a *confirm selection* pop-up, and if confirmed, the changes are committed to nonvolatile memory to store all the modifications in non-volatile memory.

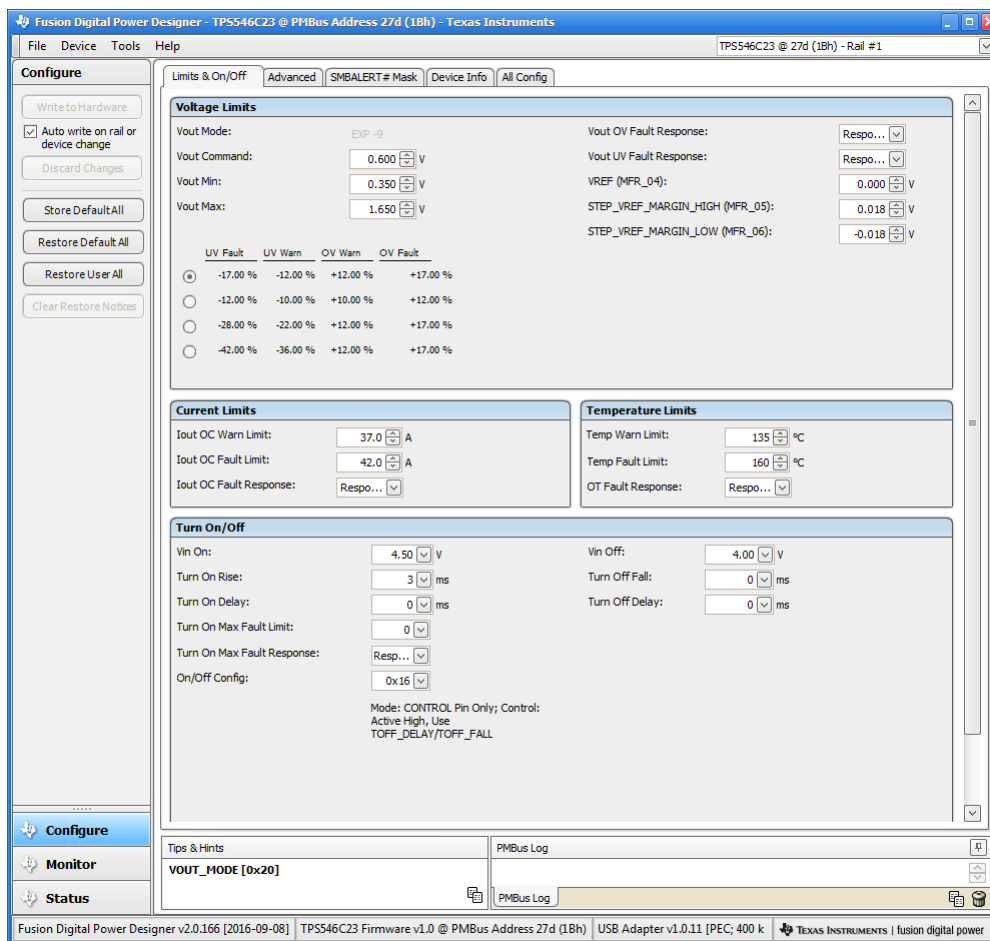

Figure 30. Configure- Limits and On/Off

Changing the on/off configuration prompts a pop-up window with details of the options [Figure 31](#).

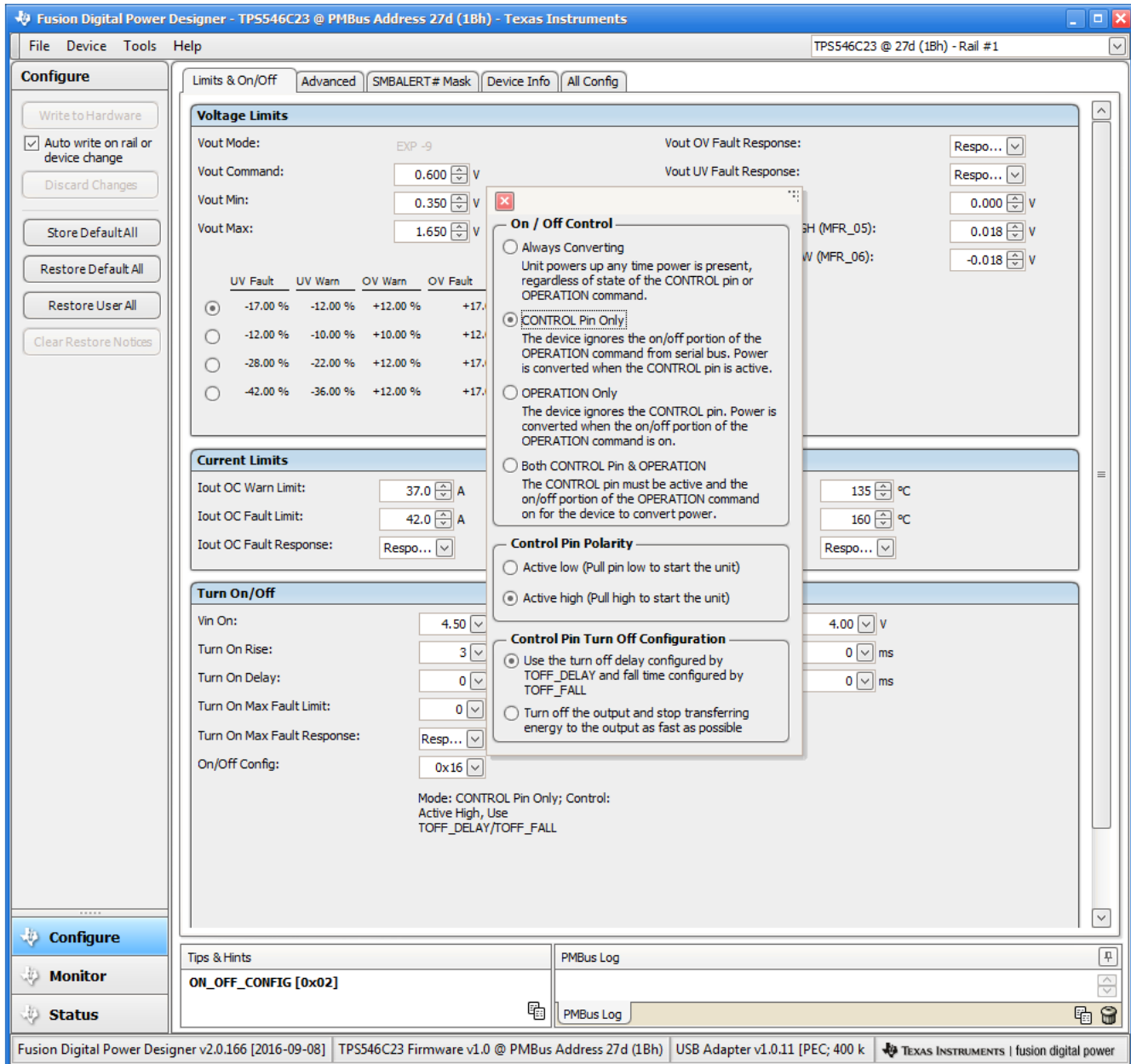

Figure 31. ON/OFF Control Pop-up

- Use the **Advanced** tab [Figure 32](#) to configure:
 - **OPTIONS:** MFR_SPECIFIC_21 register
 - **API_OPTIONS:** MFR_SPECIFIC_32 register

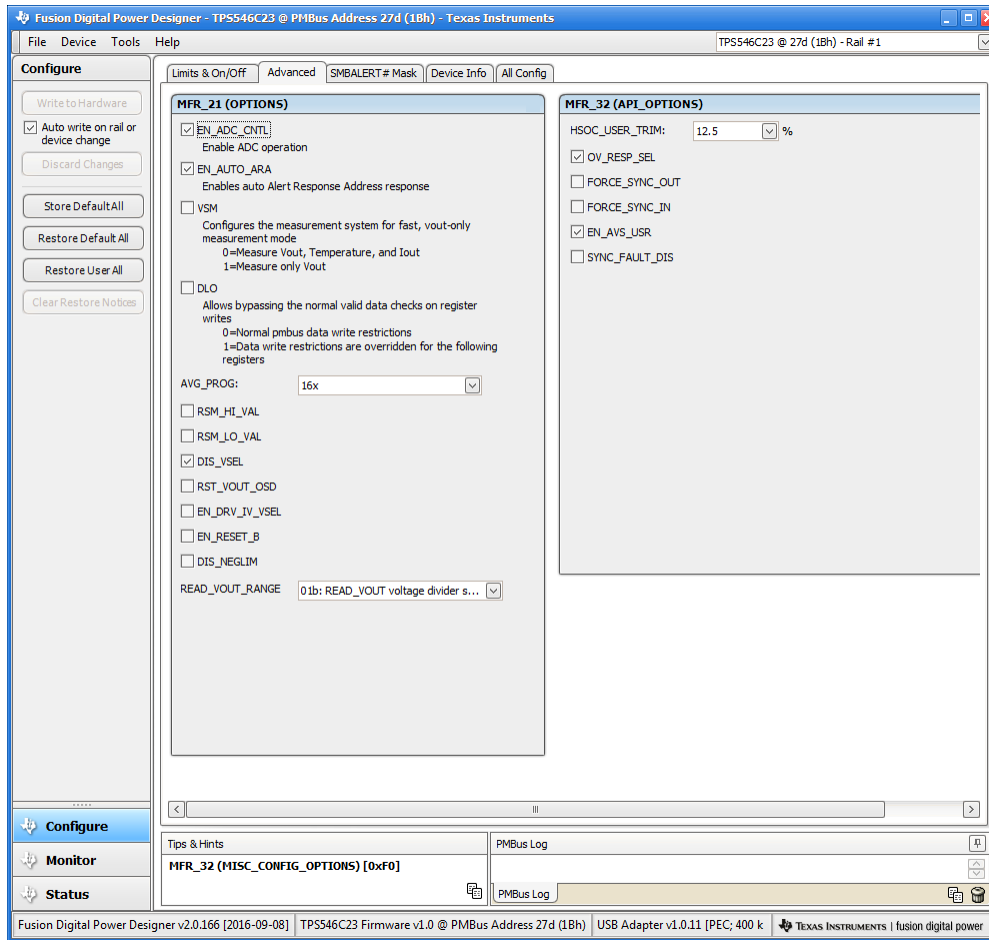

Figure 32. Configure - Advanced

The sources of SMBALERT which can be masked can be found and configured on the **SMBALERT # Mask** tab [Figure 33](#)

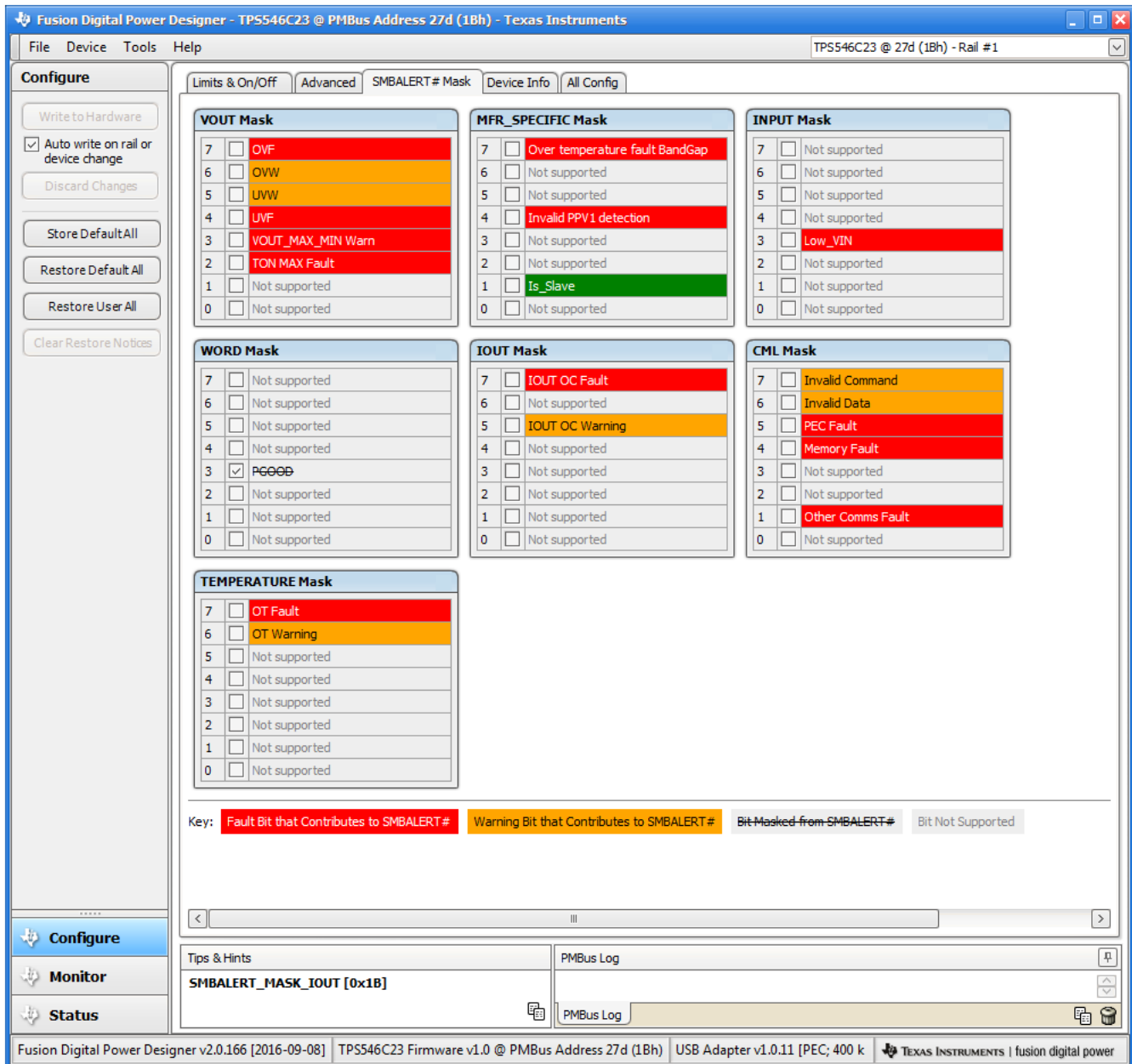

Figure 33. Configure - SMBALERT # Mask

The device information, User Scratch Pad, Write Protection options, the configuration of Vout Scale loop, Vout Transition Rate and Iout Cal Offset can be found on **Device Info** tab [Figure 34](#).

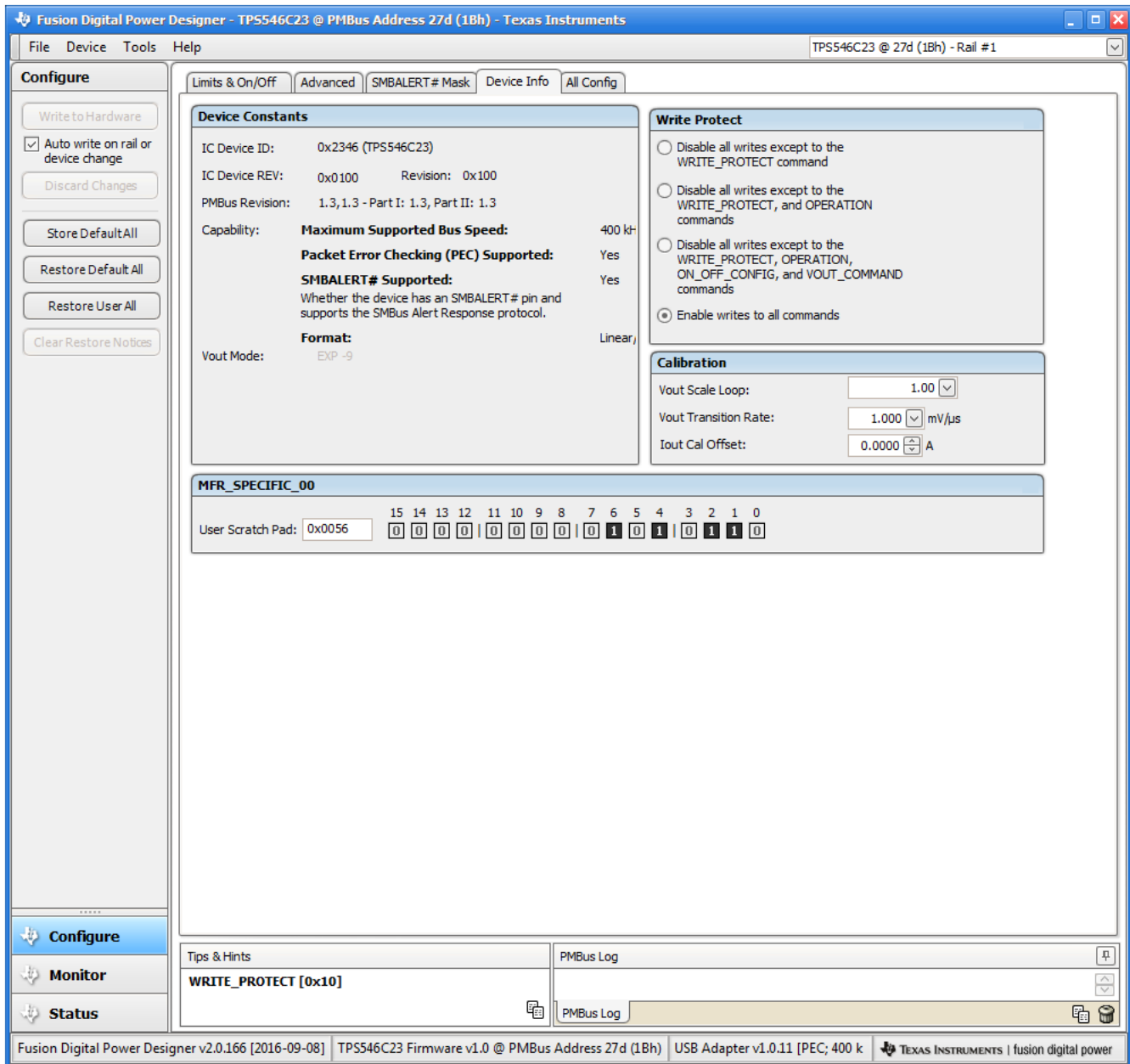

Figure 34. Configure - Device Info

Use the **All Config** tab [Figure 35](#) to configure all of the configurable parameters, which also shows other details like Hex encoding.

When multiple PMBUS compatible devices are tie to same bus interface, a scroll-down menu in the upper right corner can be used to switch view screens from one output rail to another output rail [Figure 35](#).

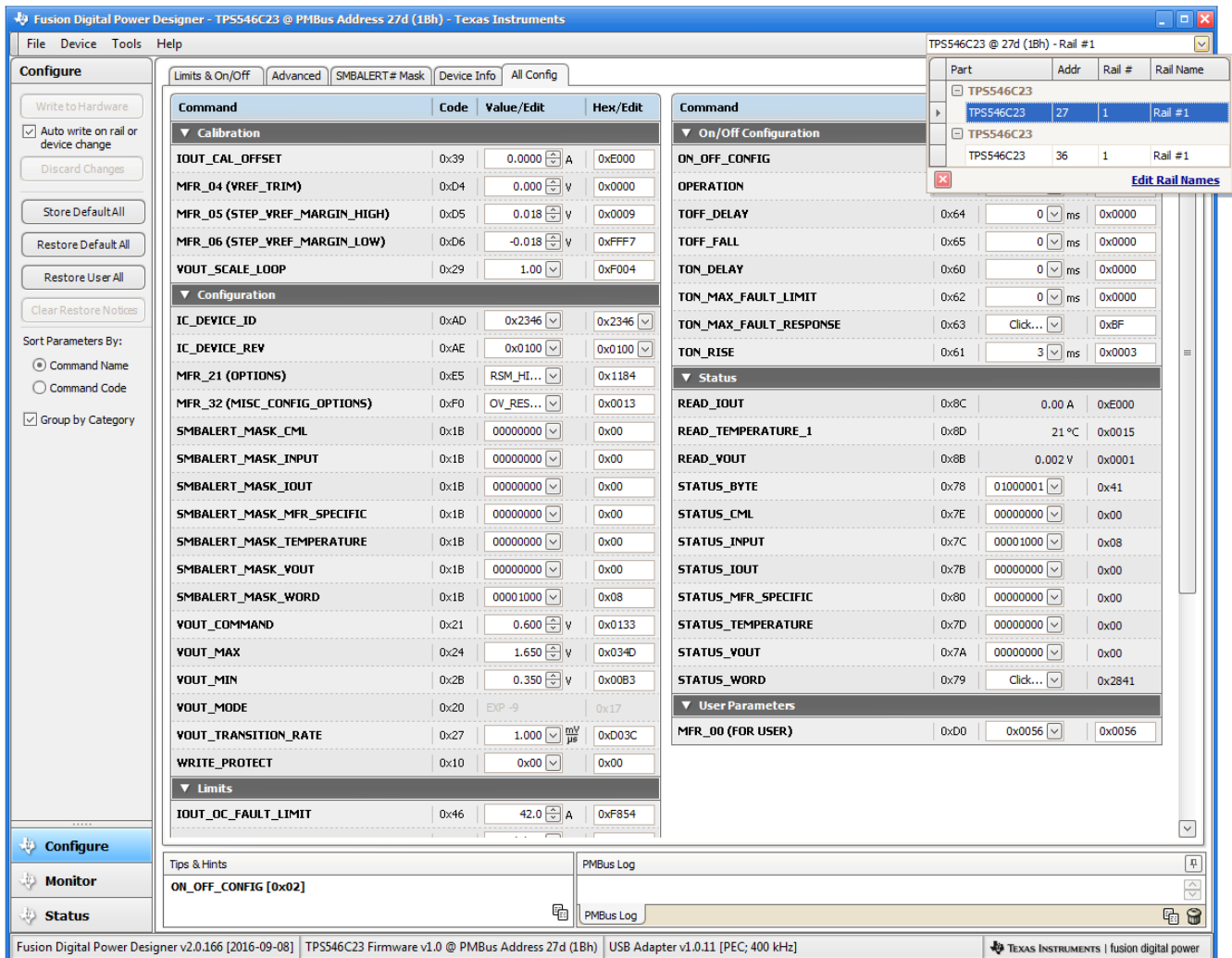

Figure 35. Configure - All Config

When the *Monitor* screen [Figure 36](#) is selected, the screen changes to display real-time data of the parameters that are measured by the device. This screen provides access to:

- Graphs of V_{OUT} , I_{out} , *Temperature*, and *Pout*.
- *Start/Stop Polling* which turns ON or OFF the real-time display of data.
- Quick access to On/Off config
- Control pin activation, and OPERATION command.
- Margin control.
- Clear Fault. Selecting **Clear Faults** clears any prior fault flags.



Figure 36. Monitor Screen

Selecting *Status* screen [Figure 37](#) from lower left corner shows the status of the device .

The screenshot displays the 'Status' screen of the Fusion Digital Power Designer software. The interface includes a menu bar (File, Device, Tools, Help), a title bar (Fusion Digital Power Designer - TPS546C23 @ PMBus Address 27d (1Bh) - Texas Instruments), and a main content area with several status registers. A left sidebar contains buttons for 'Stop Polling', 'Launch Dashboard', 'Clear Faults', and 'ARA'. A legend at the bottom identifies bit states: Fault (red), Warning (yellow), See other register (blue), Bit not set (grey), and Bit not implemented (light grey). The status registers are as follows:

- STATUS_VOUT**: 7 OVF, 6 OVW, 5 UVW, 4 UVF, 3 VOUT_MAX_MIN Warn, 2 TON MAX Fault, 1 0, 0 0.
- STATUS_IOUT**: 7 IOUT OC Fault, 6 IOUT OC Fault with LV Shutdown, 5 IOUT OC Warning, 4 IOUT UC Fault, 3 Current Share Fault, 2 Power Limiting Mode, 1 POUT OP Fault, 0 POUT OP Warning.
- STATUS_TEMP**: 7 OT Fault, 6 OT Warning, 5 UT Fault, 4 UT Warning, 3 Reserved, 2 Reserved, 1 Reserved, 0 Reserved.
- STATUS_WORD**: 15 VFW, 14 OCFW, 13 INPUT, 12 MFR fault/warn, 11 PGOOD_Z, 10 FANS, 9 OTHER, 8 Unknown, 7 Busy, 6 OFF, 5 OVW, 4 OCF, 3 Vout_MAX_Warning, 2 OTFW, 1 CML, 0 OTH.
- STATUS_CML**: 7 Invalid Command, 6 Invalid Data, 5 PEC Fault, 4 Memory Fault, 3 Processor Fault, 2 Reserved, 1 Other Comms Fault, 0 Other Memory/Logic Fault.
- STATUS_INPUT**: 7 Vin OV Fault, 6 Vin OV Warning, 5 Vin UV Warning, 4 Vin UV Fault, 3 Low_VIN, 2 IIN OC Fault, 1 IIN OC Warning, 0 PIN OP Warning.
- STATUS_FANS_1_2**: 7 Fan 1 Fault, 6 Fan 2 Fault, 5 Fan 1 Warning, 4 Fan 2 Warning, 3 Fan 1 Speed Overridden, 2 Fan 2 Speed Overridden, 1 Air Flow Fault, 0 Air Flow Warning.
- STATUS_FANS_3_4**: 7 Fan 3 Fault, 6 Fan 4 Fault, 5 Fan 3 Warning, 4 Fan 4 Warning, 3 Fan 3 Speed Overridden, 2 Fan 4 Speed Overridden, 1 Reserved, 0 Reserved.
- STATUS_MFR_SPECIFIC**: 7 Over temperature fault Band, 6 FSM Illegal ZERO state, 5 FSM Illegal MANY ONES state, 4 Invalid PPV1 detection, 3 Invalid PPV0 detection, 2 RESET VOUT, 1 Is_Slave, 0 SYNC_FAULT.
- STATUS_OTHER**: 7 Reserved, 6 Reserved, 5 Input A fuse Or circuit breaker fault, 4 Input B fuse or circuit breaker fault, 3 Input A OR-ing device fault, 2 Input B OR-ing device fault, 1 Output OR-ing device fault, 0 Reserved.

At the bottom, the status bar shows: 4 New PMBus Log Messages [Show PMBus Log](#), Unique open/close settings for Configure, Monitor, and Status (checked), and version information: Fusion Digital Power Designer v2.0.166 [2016-09-08], TPS546C23 Firmware v1.0 @ PMBus Address 27d (1Bh), USB Adapter v1.0.11 [PEC; 400 kHz], TEXAS INSTRUMENTS | fusion digital power.

Figure 37. Status Screen

IMPORTANT NOTICE

Texas Instruments Incorporated and its subsidiaries (TI) reserve the right to make corrections, enhancements, improvements and other changes to its semiconductor products and services per JESD46, latest issue, and to discontinue any product or service per JESD48, latest issue. Buyers should obtain the latest relevant information before placing orders and should verify that such information is current and complete. All semiconductor products (also referred to herein as "components") are sold subject to TI's terms and conditions of sale supplied at the time of order acknowledgment.

TI warrants performance of its components to the specifications applicable at the time of sale, in accordance with the warranty in TI's terms and conditions of sale of semiconductor products. Testing and other quality control techniques are used to the extent TI deems necessary to support this warranty. Except where mandated by applicable law, testing of all parameters of each component is not necessarily performed.

TI assumes no liability for applications assistance or the design of Buyers' products. Buyers are responsible for their products and applications using TI components. To minimize the risks associated with Buyers' products and applications, Buyers should provide adequate design and operating safeguards.

TI does not warrant or represent that any license, either express or implied, is granted under any patent right, copyright, mask work right, or other intellectual property right relating to any combination, machine, or process in which TI components or services are used. Information published by TI regarding third-party products or services does not constitute a license to use such products or services or a warranty or endorsement thereof. Use of such information may require a license from a third party under the patents or other intellectual property of the third party, or a license from TI under the patents or other intellectual property of TI.

Reproduction of significant portions of TI information in TI data books or data sheets is permissible only if reproduction is without alteration and is accompanied by all associated warranties, conditions, limitations, and notices. TI is not responsible or liable for such altered documentation. Information of third parties may be subject to additional restrictions.

Resale of TI components or services with statements different from or beyond the parameters stated by TI for that component or service voids all express and any implied warranties for the associated TI component or service and is an unfair and deceptive business practice. TI is not responsible or liable for any such statements.

Buyer acknowledges and agrees that it is solely responsible for compliance with all legal, regulatory and safety-related requirements concerning its products, and any use of TI components in its applications, notwithstanding any applications-related information or support that may be provided by TI. Buyer represents and agrees that it has all the necessary expertise to create and implement safeguards which anticipate dangerous consequences of failures, monitor failures and their consequences, lessen the likelihood of failures that might cause harm and take appropriate remedial actions. Buyer will fully indemnify TI and its representatives against any damages arising out of the use of any TI components in safety-critical applications.

In some cases, TI components may be promoted specifically to facilitate safety-related applications. With such components, TI's goal is to help enable customers to design and create their own end-product solutions that meet applicable functional safety standards and requirements. Nonetheless, such components are subject to these terms.

No TI components are authorized for use in FDA Class III (or similar life-critical medical equipment) unless authorized officers of the parties have executed a special agreement specifically governing such use.

Only those TI components which TI has specifically designated as military grade or "enhanced plastic" are designed and intended for use in military/aerospace applications or environments. Buyer acknowledges and agrees that any military or aerospace use of TI components which have **not** been so designated is solely at the Buyer's risk, and that Buyer is solely responsible for compliance with all legal and regulatory requirements in connection with such use.

TI has specifically designated certain components as meeting ISO/TS16949 requirements, mainly for automotive use. In any case of use of non-designated products, TI will not be responsible for any failure to meet ISO/TS16949.

Products

Audio	www.ti.com/audio
Amplifiers	amplifier.ti.com
Data Converters	dataconverter.ti.com
DLP® Products	www.dlp.com
DSP	dsp.ti.com
Clocks and Timers	www.ti.com/clocks
Interface	interface.ti.com
Logic	logic.ti.com
Power Mgmt	power.ti.com
Microcontrollers	microcontroller.ti.com
RFID	www.ti-rfid.com
OMAP Applications Processors	www.ti.com/omap
Wireless Connectivity	www.ti.com/wirelessconnectivity

Applications

Automotive and Transportation	www.ti.com/automotive
Communications and Telecom	www.ti.com/communications
Computers and Peripherals	www.ti.com/computers
Consumer Electronics	www.ti.com/consumer-apps
Energy and Lighting	www.ti.com/energy
Industrial	www.ti.com/industrial
Medical	www.ti.com/medical
Security	www.ti.com/security
Space, Avionics and Defense	www.ti.com/space-avionics-defense
Video and Imaging	www.ti.com/video

TI E2E Community

e2e.ti.com