

EVM User's Guide: THVD24X2VEVM

THVD24X2VEVM User's Guide



Parker Dodson

Description

This EVM user's guide for the THVD24X2VEVM provides a quick method to evaluate TI's THVD24X2V family of full duplex transceivers in a SOIC package. This EVM user's guide describes the THVD24X2VEVM and the intended use of the evaluation module.

Features

- Ready to use out-of-box with THVD2452VDR preinstalled
- Two 10- μ F and two 47- μ F decoupling capacitors installed on VCC to GND and GND to EARTH connections
- Resistor pad available to create resistive link between GND and EARTH connections
- Common-mode voltage connection points to test device with multiple common-mode voltages

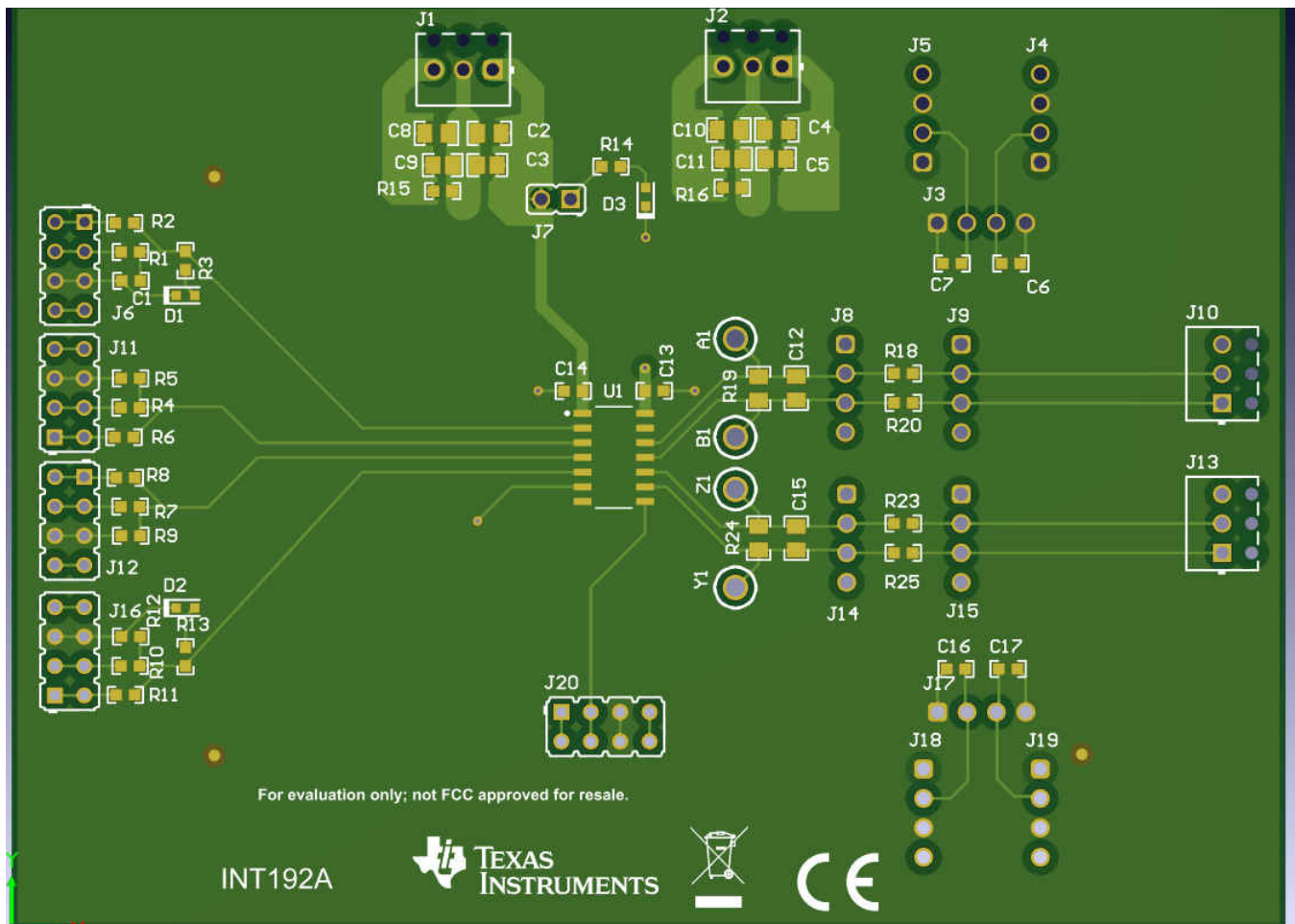

Figure 1-1. THVD24X2VEVM Top View

1 Evaluation Module Overview

1.1 Kit Contents

The THVD24X2VEVM is ready to operate directly out-of-box with a THVD2452VDR transceiver in a D package installed at site U1 on the board. In addition to the preinstalled THVD2452VDR, the following tables describe each pad on the THVD24X2VEVM board and which components are already installed by default.

[Table 1-1](#) describes the jumpers (J1 through J20) that are preinstalled on the THVD24X2VEVM board and the function of the jumper for operating the EVM.

Table 1-1. Jumper Pads on the THVD24X2VEVM Board

Jumper Name	Function	Package	Comment
J1	VIO supply input	3 pin terminal block	N/A
J2	VCC supply input	3 pin terminal block	N/A
J3	RX common-mode input	4-pin header	N/A
J4	RX "B" pin common-mode input	4-pin header	N/A
J5	RX "A" pin common-mode input	4-pin header	N/A
J6	R pin output	8-pin header	N/A
J7	Shunt to short VCC = VIO	2-pin header	Shunt J7 for single supply application
J8	Common-mode + RX bus connection point	4-pin header	N/A
J9	Input header A/B pins	4-pin header	N/A
J10	RX bus external connection terminal	3-pin terminal block	N/A
J11	"/RE" pin input	8-pin header	N/A
J12	"DE" pin input	8-pin header	N/A
J13	TX bus external connection terminal	3-pin terminal block	N/A
J14	Common-mode + TX bus connection point	4-pin header	N/A
J15	Output header Y/Z pins	4-pin header	N/A
J16	"D" pin input	8-pin header	N/A
J17	TX common-mode input	4-pin header	N/A
J18	TX "Y" pin common-mode input	4-pin header	N/A
J19	TX "Z" pin common-mode input	4-pin header	N/A
J20	SLR control input	8-pin header	Can be shunted to VIO or GND using J20

Table 1-2 describes the pads on the THVD24X2VEVM board where resistors are installed by default and pads where additional resistors can be added.

Table 1-2. Resistor Pads on the THVD24X2VEVM Board

Pad Name	Function	Package	Comment	Installed?
R1	0-Ω resistor	0603	Connection between J6 and "R" pin on U1	Yes
R2	Pullup resistor pad	0603	Ability to pull up "R" pin output	No
R3	Current limiting resistor for LED	0603	Limits current on "R" pin LED (D1)	Yes
R4	0-Ω resistor	0603	Connection between J11 and "/RE" pin of U1	Yes
R5	Pulldown resistor pad	0603	Ability to pull down "/RE" pin output	No
R6	Pullup Resistor Pad	0603	Ability to pull up "/RE" pin output	No
R7	0-Ω resistor	0603	Connection between J12 and "DE" pin for U1	Yes
R8	Pullup resistor pad	0603	Ability to pull up "DE" pin output	No
R9	Pulldown resistor pad	0603	Ability to pull down "DE" pin output	No
R10	0-Ω resistor	0603	Connection between J16 and "D" pin of U1	Yes
R11	Pullup resistor pad	0603	Ability to pull up "D" pin output	No
R12	Pulldown resistor pad	0603	Ability to pull down "D" pin output	No
R13	Current limiting resistor for LED	0603	Limits current on "D" pin LED (D2)	Yes
R14	Current limiting resistor for LED	0603	Limits current on "VCC" pin LED (D3)	Yes
R15	GND to EARTH resistor pad	0603	Located on VIO Supply (J1)	No
R16	GND to EARTH resistor pad	0603	Located on VCC Supply (J2)	No
R17	Common-mode loading resistor	0603	"A" Pin common-mode loading resistor; minimum value is 375 Ω	Yes
R18	0-Ω resistor	0603	"A" Pin bus connection resistor to output terminal	Yes
R19	A-B termination resistor pad	0805	120-Ω nominal resistance recommended if added	No
R20	0-Ω resistor	0603	"B" Pin bus connection resistor to output terminal	Yes
R21	Common-mode loading resistor	0603	"B" Pin common-mode loading resistor; minimum value is 375 Ω	No
R22	Common-mode loading resistor	0603	"Z" Pin common-mode loading resistor; minimum value is 375 Ω	No
R23	0-Ω resistor	0603	"Z" Pin Bus Connection Resistor to Output Terminal	Yes
R24	Y-Z termination resistor pad	0805	120-Ω nominal resistance recommended if added	No
R25	0-Ω resistor	0603	"Y" Pin Bus Connection Resistor to Output Terminal	Yes
R26	Common-mode loading resistor	0603	"Y" Pin common-mode loading resistor; minimum value is 375 Ω	No

Table 1-3 describes the pads on the THVD24X2VEVM board where capacitors are installed by default and where additional capacitors can be added.

Table 1-3. Capacitor Pads on the THVD24X2VEVM Board

Pad Name	Function	Package	Comment	Installed?
C1	Load capacitance for "R"	0603	N/A	No
C2	47- μ F, 10-V decoupling capacitor	0805	From VIO to GND on VIO supply	No
C3	10- μ F, 6.3-V decoupling capacitor	0805	From VIO to GND on VIO supply	Yes
C4	47- μ F, 10-V decoupling capacitor	0805	From VCC to GND on VCC supply	No
C5	10- μ F, 6.3-V decoupling capacitor	0805	From VCC to GND on VCC supply	Yes
C6	100-nF, 25-V decoupling capacitor	0805	"B" line common-mode decoupling capacitor	Yes
C7	100-nF, 25-V decoupling capacitor	0805	"A" line common-mode decoupling capacitor	Yes
C8	47- μ F, 10-V decoupling capacitor	0805	From GND to EARTH on VIO supply	No
C9	10- μ F, 6.3-V decoupling capacitor	0805	From GND to EARTH on VIO supply	Yes
C10	47- μ F, 10-V decoupling capacitor	0805	From GND to EARTH on VCC supply	No
C11	10- μ F, 6.3-V decoupling capacitor	0805	From GND to EARTH on VCC supply	Yes
C12	Termination capacitance pad	0805	A to B capacitor pad to test different capacitive loading conditions	No
C13	100-nF, 6.3-V decoupling capacitor	0603	U1 VCC decoupling capacitor	Yes
C14	100-nF, 6.3-V decoupling capacitor	0603	U1 VIO decoupling capacitor	Yes
C15	Termination capacitance pad	0805	Y to Z capacitor pad to test different capacitive loading conditions	No
C16	100-nF, 25-V decoupling capacitor	0805	"Y" line common-mode decoupling capacitor	Yes
C17	100-nF, 25-V decoupling capacitor	0805	"Z" line common-mode decoupling capacitor	Yes

The THVD24X2VEVM has three LEDs preinstalled on pads D1, D2, and D3. These LEDs are in a non-standard package. Table 1-4 provides the location and the function of each LED.

Table 1-4. LED Pads on the THVD24X2VEVM Board

Pad Name	Function
D1	"R" line LED (Red)
D2	"D" line LED (Green)
D3	"VCC" LED (Blue)

Table 1-5 provides information about the device preinstalled on the EVM.

Table 1-5. Included IC for the THVD24X2VEVM

IC ID	Function	Package	Comment	Installed?
U1	THVD24X2VDR Footprint	D	Preinstalled with THVD2452VDR	Yes

The default setup of the THVD24X2VEVM is optimized for working with the THVD2452VDR, operating in a single supply mode without a common-mode voltage. By shorting the headers at site J7 (VIO = VCC) and attaching a valid power supply to VCC, the board is placed in the default state and is ready to operate.

2 Operating the EVM

2.1 Setup

The THVD24X2VEVM can operate with either a single supply or dual supply. In single supply operation, the logic supply is equal to the main voltage supply. In dual supply mode, the supplies for the digital logic and driver are separate. The following sections detail the jumper configuration for each operation mode.

2.1.1 Single Supply Operation

The THVD24X2V family of transceivers in the D (SOIC) package from TI can have an additional logic supply pin, VIO. This pin is used to power the internal digital logic circuits inside of the device. In single supply operation

mode, for devices like the THVD2452VDR, the VIO pin can be shorted to VCC by shorting the header pins of J7, so that the digital circuits are properly powered.

Table 2-1. Single Supply Operation Jumper Configurations

Component Name	Comment
J7	Shorted for single supply operation
J1	VIO supply: leave open
J2	VCC power terminal

Apply VCC through the J2 terminal to power the EVM. With the board oriented with J6 on the top left, as shown in [Figure 2-1](#), the signals are, from right to left, EARTH, GND, and VCC. The EARTH and GND signal distinction is used to help the end user to determine operational qualities with respect to ground potential differences. Install a resistor on pad R16 for testing methods on reducing ground loop current. Check the data sheet for proper powering considerations as supply recommendations can range from 3.3 V, 5 V, or 3.3 V to 5 V.

Providing power to the EVM is similar to the single supply option described in this section. Jumpers J1 and J2 have the same pin orientation from left to right: EARTH pin, GND pin, and voltage supply pin. Attach the VIO power source to J1 and VCC power source to J2.

2.1.2 Dual Supply Operation

The THVD24X2V family of transceivers in the D (SOIC) package from TI can have an additional logic supply pin, VIO. In dual supply operation, the digital circuit supply (which supplies the R, D, /RE, and DE pins) can be held at a low voltage. This voltage typically ranges from 1.65 V to 5 V to allow interfacing with a RS-485 transceiver to digital systems using 1.8 V logic. For dual supply operation, J7 is left open.

Table 2-2. Dual Supply Operation Jumper Configurations

Component Name	Comment
J7	Leave open for dual supply operation
J1	VIO power input
J2	VCC power input

2.2 Operating the THVD24X2VEVM in Default Setup

Out-of-the-box the EVM, when powered, can operate the THVD2452V as a full duplex RS-485 transceiver. The device pins are separated into four distinct groups: single-ended communication pins, differential communication pins, power pins, and control pins. The preceding section [Section 2.1](#) discusses the power pins in depth, the other three types of pins are covered in this section.

The single-ended communication pins are connected directly through the respective jumpers to a single ended bus. These pins are the “R” and “D” pins and represent RX and TX single-ended data, respectively. R is referenced to J6 and D is reference to J16. J6 and J16 are the signal connection points for the EVM.

The EVM board supports two control signals: the enable pins and a slew rate control pin. The enable pins include an active high Driver Enable (DE) pin and an active low Receiver Enable (/RE) pin. These pins are accessed through jumpers J11 and J12, respectively. The Slew Rate Limiting pin (SLR) is a binary input that can implement slew rate limiting to reduce emissions from the device at the cost of lower data rates. The SLR pin is accessed through jumper J20.

The final group of signals, differential bus pins, are pins A, B, Y, and Z. The A and B pins are differential receiver pins that are connected to terminal block J10. As is shown in [Figure 2-1](#), with the board oriented to have J6 at the top-left corner, the 2nd and 3rd pins of J10 are A and B, respectively. Y and Z are the differential driver pins that are connected to terminal block J13. Using the same orientation shown in [Figure 2-1](#), the 2nd and 3rd pins of J13 are differential driver pins Z and Y, respectively.

Most signal inputs are use 2x4 headers. Each jumper has a specific mapping that connects the I/O, GND, VIO, and EARTH (when present).

Board Orientation – J6 At Top Right Corner of Board

Jumpers: J16 and J11

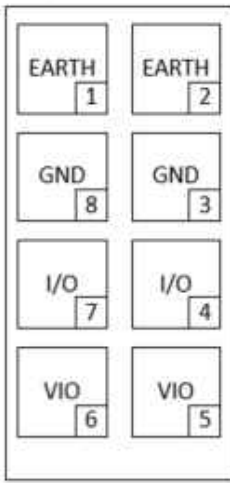

Jumpers: J6 and J12

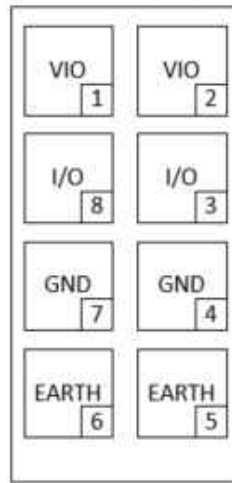

Jumper: J20

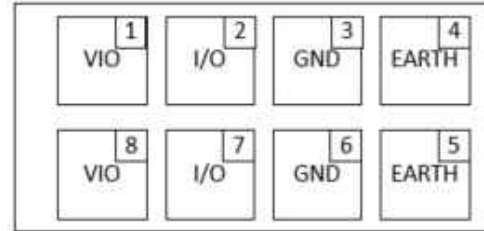

Figure 2-1. Jumper Map

Table 2-3. Jumper and Pin Descriptions

Jumper Name	Signal – Jumper Pin	Comment
J6	R – J6 Pin 3 or 8	Receive Data – to keep constant high or low, shunt J6 I/O pins to VIO or GND
J11	/RE – J11 Pin 4 or 7	/RE – shunt J11 I/O pins to VIO or GND if only one mode is used
J12	DE – J12 Pin 3 or 8	DE – shunt J12 I/O pins to VIO or GND if only one mode is used
J16	D – J16 Pin 4 or 7	D – to keep constant high or low, shunt J16 I/O pins to VCC or GND
J20	SLR – Pin 2 or 7	Shunt I/O pin on J20 to either High (SLR active) or Low (SLR disabled)
J10	Pin 2: A; Pin 3: B	Differential bus input terminal
J13	Pin 2: Z; Pin 3: Y	Differential bus output terminal
J1	N/A	Leave floating for single supply applications, attach digital supply if dual operation is used
J2	N/A	Attach VCC to J2
J7	N/A	Shunt for single supply Open for dual supply

2.3 Operating the THVD24X2VEVM With Modifications

2.3.1 Single-ended Bus Modification Operational Modes

There are a few options for modifying the single ended data and control signals on this EVM. Jumpers J6, J11, J12, and J16 all contain pads that are blank by default. For D, DE, and /RE signals there are 0603-sized pads for either pullup or pulldown resistors to have a default logic on these pins with the added benefit of still being able to external signals to this pin. The R pin also contains a 0603-sized pullup resistor, as is common in UART based applications, as well as a 0603-sized pad that connects to ground for a capacitive load for testing cases that requires capacitive loading on the R pin. A summary of possible single-ended signal pathway modifications on the EVM are in [Table 2-4](#).

Table 2-4. Possible Single-ended Signal Pathways

Associated Jumper or Signal	Pad Name	Comment
J6 / R	R2	Pullup resistor pad
J6 / R	C1	Capacitive load pad
J11 //RE	R6	Pullup resistor pad
J11 //RE	R5	Pulldown resistor pad
J12 / DE	R8	Pullup resistor pad
J12 / DE	R9	Pulldown resistor pad
J16 / D	R11	Pullup resistor pad
J16 / D	R12	Pulldown resistor pad

2.3.2 Differential Signal Bus Modification Operational Mode

The differential side of the RS-485 transceiver also has a few possible minor modifications that can be made by the user. There is the option for a termination capacitor and resistor, C12 and R19 for A and B pins and C15 and R24 for Y or Z. These capacitor and termination pads can help model termination and different loading effects on the IC. Another common modification is applying a common-mode voltage through the common-mode jumpers J3 through J5 (RX bus) and J17 through J19 (TX bus), which is routed to the respective bus through common-mode resistors: R17 (A), R21 (B), R22 (Z), and R26 (Y). These resistors are not installed by default. For full common-mode testing, resistors R17, R21, R22, and R26 can be 375 Ω , which is the standard value for RS-485 devices.

Table 2-5. Possible Modifications for Differential Signal Bus

Associated Jumper / Signal	Pad Name	Comment
J3 and J5 / Common Mode on "A"	R17	Common Mode Resistor to "A"
J4 and J5 / Common Mode on "B"	R21	Common Mode Resistor to "B"
J17 and J18 / Common Mode on "Y"	R26	Common Mode Resistor to "Y"
J17 and J19 / Common Mode on "Z"	R22	Common Mode Resistor to "Z"
N/A / A and B	C12	Termination Capacitor Pad (RX)
N/A / A and B	R19	Termination Resistor Pad (RX)
N/A / Y and Z	C15	Termination Capacitor Pad (TX)
N/A / Y and Z	R24	Termination Resistor Pad (TX)

3 Hardware Design Files

3.1 Schematics

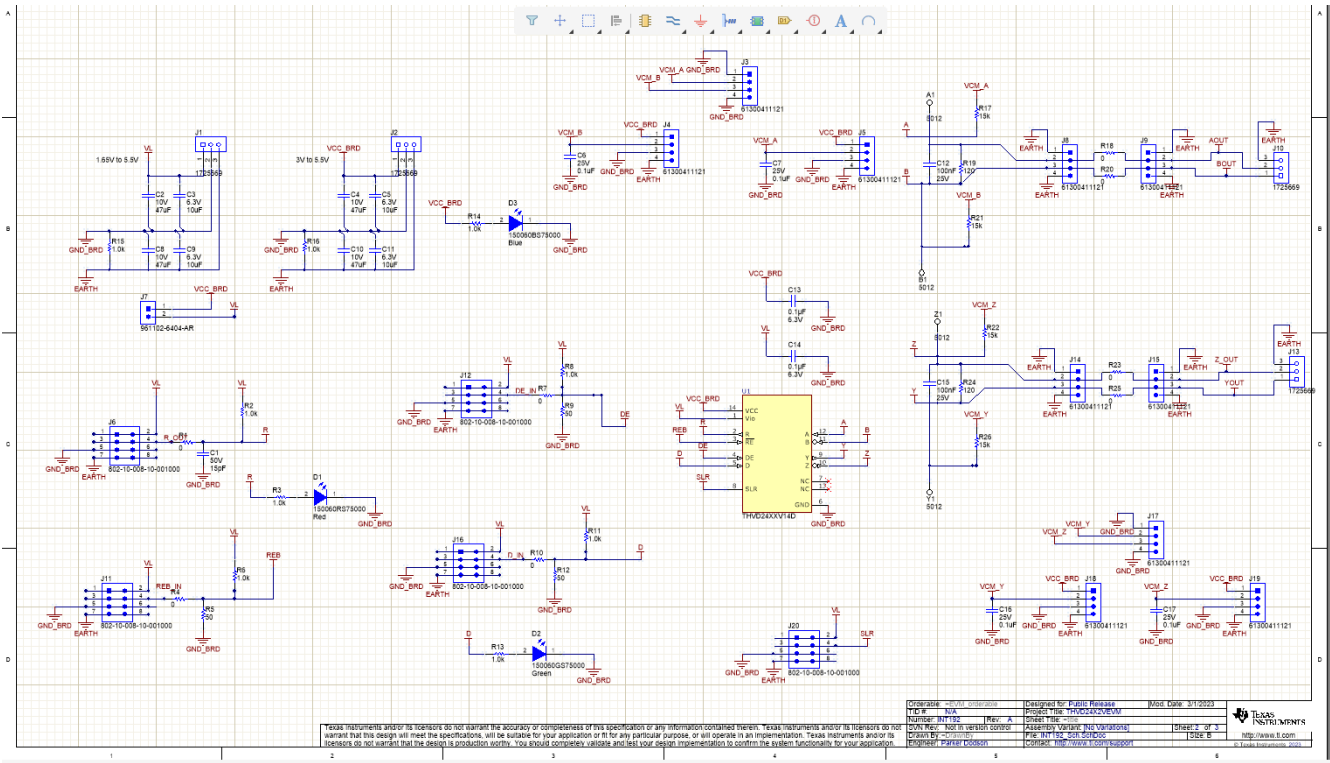

Figure 3-1. THVD24X2VEVM - Schematic (No Variant)

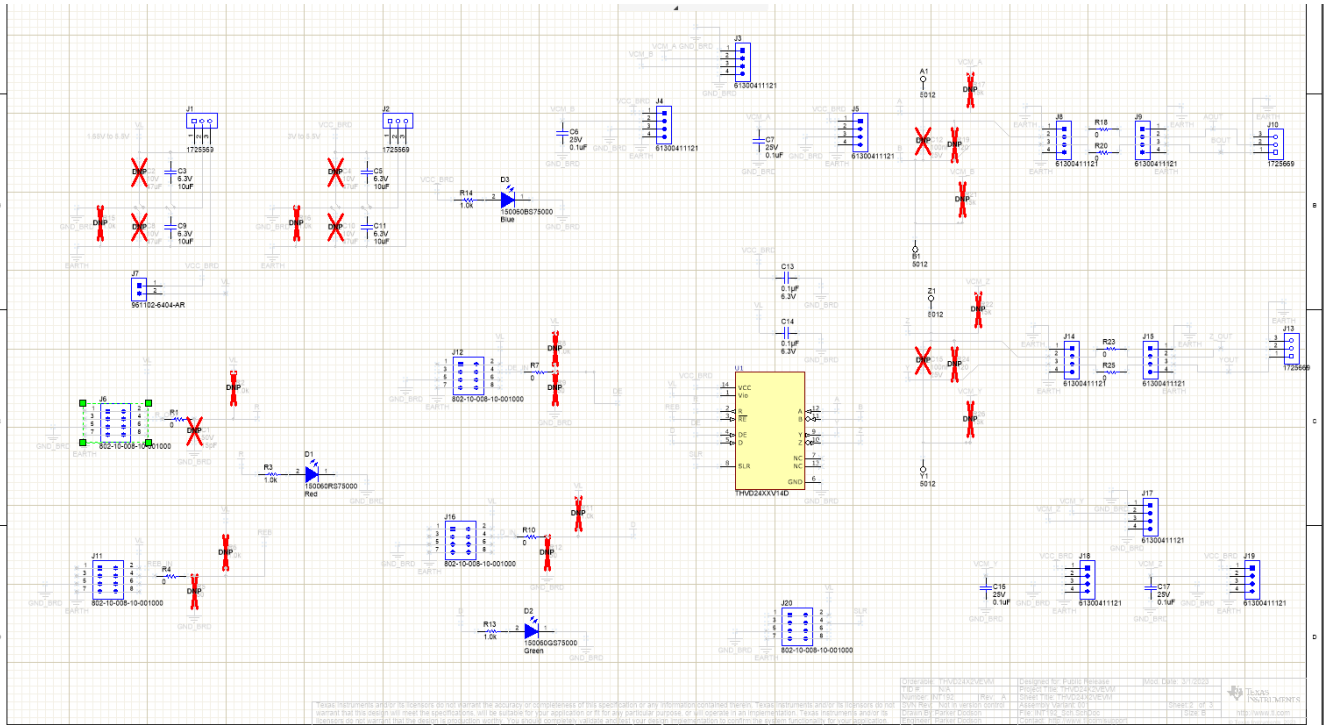

Figure 3-2. THVD24X2VEVM - Schematic (Default Variant)

3.2 PCB Layouts

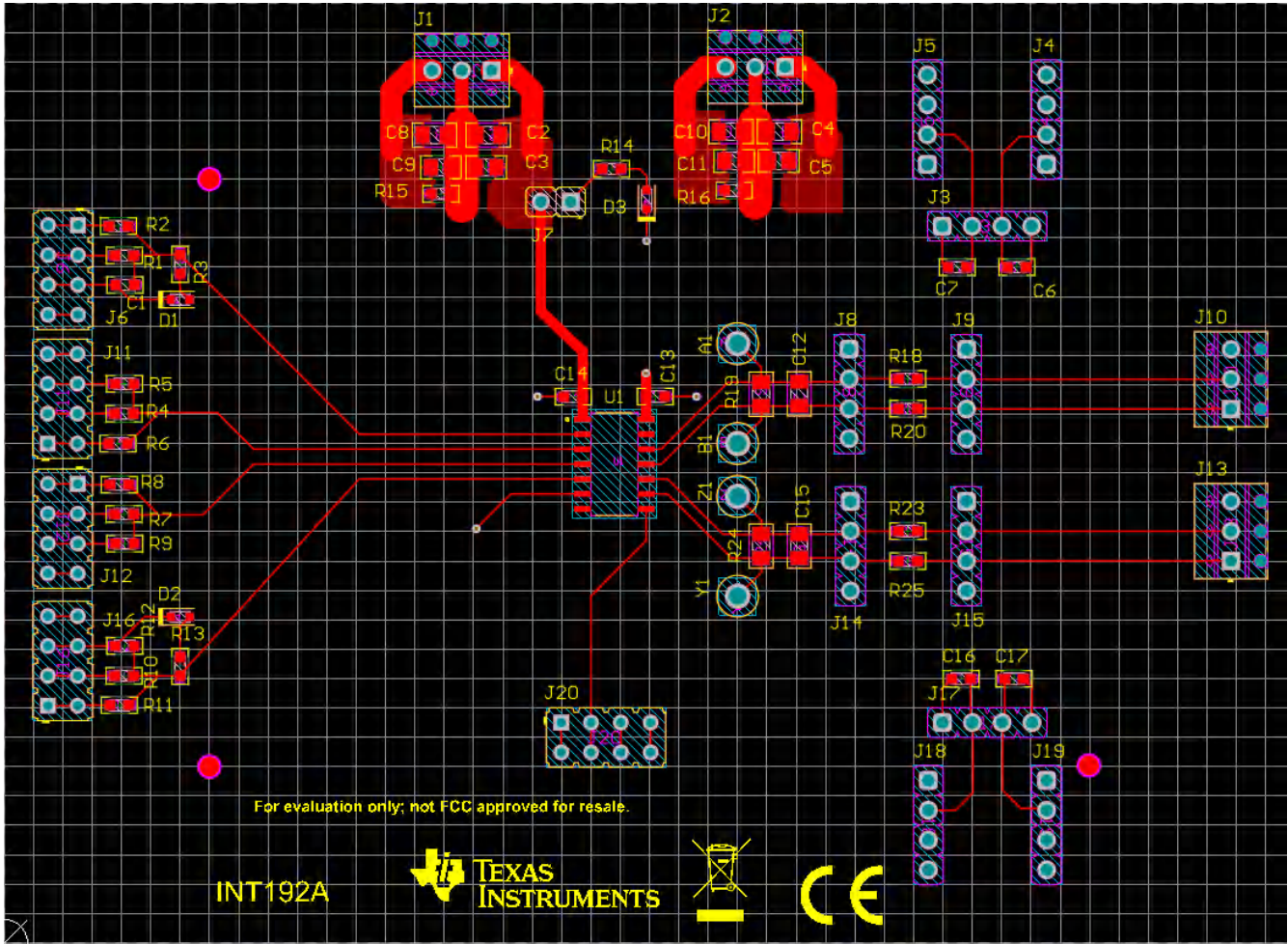

Figure 3-3. THVD24X2VEVM - Layout (Top View)

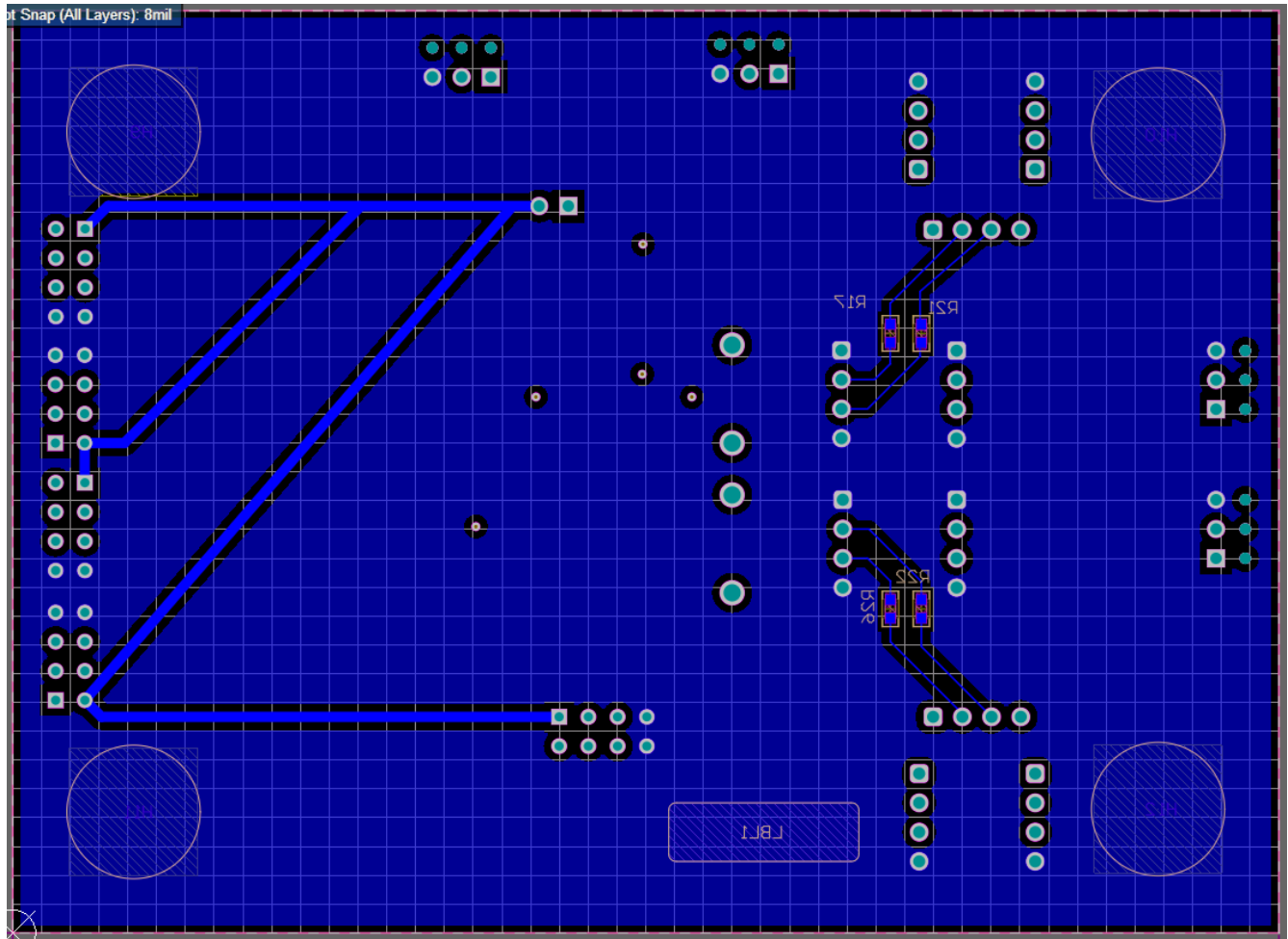

Figure 3-4. THVD24X2VEVM - Layout (Bottom View)

3.3 Bill of Materials (BOM)

Table 3-1. Bill of Materials for the THVD24X2VEVM

Designator	Quantity	Value	Description	Package Reference	Part Number	Manufacturer
A1, B1, Y1, Z1	4		Test Point, Multipurpose, White, TH	White Multipurpose Testpoint	5012	Keystone
C3, C5, C9, C11	4	10uF	CAP, CERM, 10 uF, 6.3 V, +/- 10%, X5R, 0805	0805	CL21A106KQFNNG	Samsung
C6, C7, C16, C17	4	0.1uF	CAP, CERM, 0.1 uF, 25 V, +/- 10%, X7R, 0603	0603	C1608X7R1E104K080AA	TDK
C13, C14	2	0.1uF	CAP, CERM, 0.1 uF, 6.3 V, +/- 10%, X5R, 0603	0603	C0603C104K9PAC7867	Kemet
D1	1	Red	LED, Red, SMD	LED_0603	150060RS75000	Würth Elektronik
D2	1	Green	LED, Green, SMD	LED_0603	150060GS75000	Würth Elektronik
D3	1	Blue	LED, Blue, SMD	LED_0603	150060BS75000	Würth Elektronik
H9, H10, H11, H12	4		Bumpon, Hemisphere, 0.44 X 0.20, Clear	Transparent Bumpon	SJ-5303 (CLEAR)	3M
J1, J2, J10, J13	4		Terminal Block, 3x1, 2.54 mm, TH	Terminal Block, 3x1, 2.54 mm, TH	1725669	Phoenix Contact
J3, J4, J5, J8, J9, J14, J15, J17, J18, J19	10		Header, 2.54 mm, 4x1, Gold, TH	Header, 2.54mm, 4x1, TH	61300411121	Würth Elektronik
J6, J11, J12, J16, J20	5		Header, 2.54 mm, 4x2, Gold, TH	Header, 2.54 mm, 4x2, TH	802-10-008-10-001000	Mill-Max
J7	1		Header, 2.54mm, 2x1, TH	Header, 2.54mm, 2x1, TH	961102-6404-AR	3M
LBL1	1		Thermal Transfer Printable Labels, 0.650" W x 0.200" H - 10,000 per roll	PCB Label 0.650 x 0.200 inch	THT-14-423-10	Brady
R1, R4, R7, R10, R18, R20, R23, R25	8	0	RES, 0, 0%, 0.25 W, AEC-Q200 Grade 0, 0603	0603	RCS06030000Z0EA	Vishay-Dale
R3, R13, R14	3	1.0k	RES, 1.0 k, 5%, 0.1 W, AEC-Q200 Grade 0, 0603	0603	CRCW06031K00JNEA	Vishay-Dale
U1	1		THVD2452VDR	SOIC14	THVD2452VDR	Texas Instruments
C1	0	15pF	CAP, CERM, 15 pF, 50 V, +/- 5%, COG/NP0, 0603	0603	06035A150JAT2A	AVX
C2, C4, C8, C10	0	47uF	CAP, CERM, 47 uF, 10 V, +/- 20%, X5R, 0805	0805	C2012X5R1A476M125AC	TDK
C12, C15	0	0.1uF	CAP, CERM, 0.1 uF, 25 V, +/- 10%, X7R, 0805	0805	08053C104KAT2A	AVX
FID1, FID2, FID3	0		Fiducial mark. There is nothing to buy or mount.	N/A	N/A	N/A
R2, R6, R8, R11, R15, R16	0	1.0k	RES, 1.0 k, 5%, 0.1 W, AEC-Q200 Grade 0, 0603	0603	CRCW06031K00JNEA	Vishay-Dale

Table 3-1. Bill of Materials for the THVD24X2VEVM (continued)

Designator	Quantity	Value	Description	Package Reference	Part Number	Manufacturer
R5, R9, R12	0	50	RES, 50, 2%, 3.9 W, 0603	0603	RCP0603W50R0GEB	Vishay-Dale
R17, R21, R22, R26	0	15k	RES, 15 k, 5%, 0.1 W, 0603	0603	RC0603JR-0715KL	Yageo
R19, R24	0	120	RES, 120, 5%, 0.5 W, 0805	0805	ERJ-P06J121V	Panasonic

4 Additional Information

4.1 Trademarks

All trademarks are the property of their respective owners.

5 References

- [Texas Instruments, THVD24xxV ±70-V Fault-Protected 3 V to 5.5 V RS-485 Transceivers with Flexible I/O Supply and IEC ESD data sheet](#)

STANDARD TERMS FOR EVALUATION MODULES

1. *Delivery:* TI delivers TI evaluation boards, kits, or modules, including any accompanying demonstration software, components, and/or documentation which may be provided together or separately (collectively, an "EVM" or "EVMs") to the User ("User") in accordance with the terms set forth herein. User's acceptance of the EVM is expressly subject to the following terms.
 - 1.1 EVMs are intended solely for product or software developers for use in a research and development setting to facilitate feasibility evaluation, experimentation, or scientific analysis of TI semiconductor products. EVMs have no direct function and are not finished products. EVMs shall not be directly or indirectly assembled as a part or subassembly in any finished product. For clarification, any software or software tools provided with the EVM ("Software") shall not be subject to the terms and conditions set forth herein but rather shall be subject to the applicable terms that accompany such Software
 - 1.2 EVMs are not intended for consumer or household use. EVMs may not be sold, sublicensed, leased, rented, loaned, assigned, or otherwise distributed for commercial purposes by Users, in whole or in part, or used in any finished product or production system.
2. *Limited Warranty and Related Remedies/Disclaimers:*
 - 2.1 These terms do not apply to Software. The warranty, if any, for Software is covered in the applicable Software License Agreement.
 - 2.2 TI warrants that the TI EVM will conform to TI's published specifications for ninety (90) days after the date TI delivers such EVM to User. Notwithstanding the foregoing, TI shall not be liable for a nonconforming EVM if (a) the nonconformity was caused by neglect, misuse or mistreatment by an entity other than TI, including improper installation or testing, or for any EVMs that have been altered or modified in any way by an entity other than TI, (b) the nonconformity resulted from User's design, specifications or instructions for such EVMs or improper system design, or (c) User has not paid on time. Testing and other quality control techniques are used to the extent TI deems necessary. TI does not test all parameters of each EVM. User's claims against TI under this Section 2 are void if User fails to notify TI of any apparent defects in the EVMs within ten (10) business days after delivery, or of any hidden defects with ten (10) business days after the defect has been detected.
 - 2.3 TI's sole liability shall be at its option to repair or replace EVMs that fail to conform to the warranty set forth above, or credit User's account for such EVM. TI's liability under this warranty shall be limited to EVMs that are returned during the warranty period to the address designated by TI and that are determined by TI not to conform to such warranty. If TI elects to repair or replace such EVM, TI shall have a reasonable time to repair such EVM or provide replacements. Repaired EVMs shall be warranted for the remainder of the original warranty period. Replaced EVMs shall be warranted for a new full ninety (90) day warranty period.

WARNING

Evaluation Kits are intended solely for use by technically qualified, professional electronics experts who are familiar with the dangers and application risks associated with handling electrical mechanical components, systems, and subsystems.

User shall operate the Evaluation Kit within TI's recommended guidelines and any applicable legal or environmental requirements as well as reasonable and customary safeguards. Failure to set up and/or operate the Evaluation Kit within TI's recommended guidelines may result in personal injury or death or property damage. Proper set up entails following TI's instructions for electrical ratings of interface circuits such as input, output and electrical loads.

NOTE:

EXPOSURE TO ELECTROSTATIC DISCHARGE (ESD) MAY CAUSE DEGRADATION OR FAILURE OF THE EVALUATION KIT; TI RECOMMENDS STORAGE OF THE EVALUATION KIT IN A PROTECTIVE ESD BAG.

3 Regulatory Notices:

3.1 United States

3.1.1 Notice applicable to EVMs not FCC-Approved:

FCC NOTICE: This kit is designed to allow product developers to evaluate electronic components, circuitry, or software associated with the kit to determine whether to incorporate such items in a finished product and software developers to write software applications for use with the end product. This kit is not a finished product and when assembled may not be resold or otherwise marketed unless all required FCC equipment authorizations are first obtained. Operation is subject to the condition that this product not cause harmful interference to licensed radio stations and that this product accept harmful interference. Unless the assembled kit is designed to operate under part 15, part 18 or part 95 of this chapter, the operator of the kit must operate under the authority of an FCC license holder or must secure an experimental authorization under part 5 of this chapter.

3.1.2 For EVMs annotated as FCC – FEDERAL COMMUNICATIONS COMMISSION Part 15 Compliant:

CAUTION

This device complies with part 15 of the FCC Rules. Operation is subject to the following two conditions: (1) This device may not cause harmful interference, and (2) this device must accept any interference received, including interference that may cause undesired operation.

Changes or modifications not expressly approved by the party responsible for compliance could void the user's authority to operate the equipment.

FCC Interference Statement for Class A EVM devices

NOTE: This equipment has been tested and found to comply with the limits for a Class A digital device, pursuant to part 15 of the FCC Rules. These limits are designed to provide reasonable protection against harmful interference when the equipment is operated in a commercial environment. This equipment generates, uses, and can radiate radio frequency energy and, if not installed and used in accordance with the instruction manual, may cause harmful interference to radio communications. Operation of this equipment in a residential area is likely to cause harmful interference in which case the user will be required to correct the interference at his own expense.

FCC Interference Statement for Class B EVM devices

NOTE: This equipment has been tested and found to comply with the limits for a Class B digital device, pursuant to part 15 of the FCC Rules. These limits are designed to provide reasonable protection against harmful interference in a residential installation. This equipment generates, uses and can radiate radio frequency energy and, if not installed and used in accordance with the instructions, may cause harmful interference to radio communications. However, there is no guarantee that interference will not occur in a particular installation. If this equipment does cause harmful interference to radio or television reception, which can be determined by turning the equipment off and on, the user is encouraged to try to correct the interference by one or more of the following measures:

- Reorient or relocate the receiving antenna.
- Increase the separation between the equipment and receiver.
- Connect the equipment into an outlet on a circuit different from that to which the receiver is connected.
- Consult the dealer or an experienced radio/TV technician for help.

3.2 Canada

3.2.1 For EVMs issued with an Industry Canada Certificate of Conformance to RSS-210 or RSS-247

Concerning EVMs Including Radio Transmitters:

This device complies with Industry Canada license-exempt RSSs. Operation is subject to the following two conditions:

(1) this device may not cause interference, and (2) this device must accept any interference, including interference that may cause undesired operation of the device.

Concernant les EVMs avec appareils radio:

Le présent appareil est conforme aux CNR d'Industrie Canada applicables aux appareils radio exempts de licence. L'exploitation est autorisée aux deux conditions suivantes: (1) l'appareil ne doit pas produire de brouillage, et (2) l'utilisateur de l'appareil doit accepter tout brouillage radioélectrique subi, même si le brouillage est susceptible d'en compromettre le fonctionnement.

Concerning EVMs Including Detachable Antennas:

Under Industry Canada regulations, this radio transmitter may only operate using an antenna of a type and maximum (or lesser) gain approved for the transmitter by Industry Canada. To reduce potential radio interference to other users, the antenna type and its gain should be so chosen that the equivalent isotropically radiated power (e.i.r.p.) is not more than that necessary for successful communication. This radio transmitter has been approved by Industry Canada to operate with the antenna types listed in the user guide with the maximum permissible gain and required antenna impedance for each antenna type indicated. Antenna types not included in this list, having a gain greater than the maximum gain indicated for that type, are strictly prohibited for use with this device.

Concernant les EVMs avec antennes détachables

Conformément à la réglementation d'Industrie Canada, le présent émetteur radio peut fonctionner avec une antenne d'un type et d'un gain maximal (ou inférieur) approuvé pour l'émetteur par Industrie Canada. Dans le but de réduire les risques de brouillage radioélectrique à l'intention des autres utilisateurs, il faut choisir le type d'antenne et son gain de sorte que la puissance isotrope rayonnée équivalente (p.i.r.e.) ne dépasse pas l'intensité nécessaire à l'établissement d'une communication satisfaisante. Le présent émetteur radio a été approuvé par Industrie Canada pour fonctionner avec les types d'antenne énumérés dans le manuel d'usage et ayant un gain admissible maximal et l'impédance requise pour chaque type d'antenne. Les types d'antenne non inclus dans cette liste, ou dont le gain est supérieur au gain maximal indiqué, sont strictement interdits pour l'exploitation de l'émetteur.

3.3 Japan

3.3.1 *Notice for EVMs delivered in Japan:* Please see http://www.tij.co.jp/lstds/ti_ja/general/eStore/notice_01.page 日本国内に輸入される評価用キット、ボードについては、次のところをご覧ください。

<https://www.ti.com/ja-jp/legal/notice-for-evaluation-kits-delivered-in-japan.html>

3.3.2 *Notice for Users of EVMs Considered "Radio Frequency Products" in Japan:* EVMs entering Japan may not be certified by TI as conforming to Technical Regulations of Radio Law of Japan.

If User uses EVMs in Japan, not certified to Technical Regulations of Radio Law of Japan, User is required to follow the instructions set forth by Radio Law of Japan, which includes, but is not limited to, the instructions below with respect to EVMs (which for the avoidance of doubt are stated strictly for convenience and should be verified by User):

1. Use EVMs in a shielded room or any other test facility as defined in the notification #173 issued by Ministry of Internal Affairs and Communications on March 28, 2006, based on Sub-section 1.1 of Article 6 of the Ministry's Rule for Enforcement of Radio Law of Japan,
2. Use EVMs only after User obtains the license of Test Radio Station as provided in Radio Law of Japan with respect to EVMs, or
3. Use of EVMs only after User obtains the Technical Regulations Conformity Certification as provided in Radio Law of Japan with respect to EVMs. Also, do not transfer EVMs, unless User gives the same notice above to the transferee. Please note that if User does not follow the instructions above, User will be subject to penalties of Radio Law of Japan.

【無線電波を送信する製品の開発キットをお使いになる際の注意事項】 開発キットの中には技術基準適合証明を受けていないものがあります。技術適合証明を受けていないものご使用に際しては、電波法遵守のため、以下のいずれかの措置を取っていただく必要がありますのでご注意ください。

1. 電波法施行規則第6条第1項第1号に基づく平成18年3月28日総務省告示第173号で定められた電波暗室等の試験設備でご使用いただく。
2. 実験局の免許を取得後ご使用いただく。
3. 技術基準適合証明を取得後ご使用いただく。

なお、本製品は、上記の「ご使用にあたっての注意」を譲渡先、移転先に通知しない限り、譲渡、移転できないものとします。

上記を遵守頂けない場合は、電波法の罰則が適用される可能性があることをご留意ください。日本テキサス・イ

ンスツルメンツ株式会社

東京都新宿区西新宿 6 丁目 2 4 番 1 号

西新宿三井ビル

3.3.3 *Notice for EVMs for Power Line Communication:* Please see http://www.tij.co.jp/lstds/ti_ja/general/eStore/notice_02.page

電力線搬送波通信についての開発キットをお使いになる際の注意事項については、次のところをご覧ください。 <https://www.ti.com/ja-jp/legal/notice-for-evaluation-kits-for-power-line-communication.html>

3.4 European Union

3.4.1 *For EVMs subject to EU Directive 2014/30/EU (Electromagnetic Compatibility Directive):*

This is a class A product intended for use in environments other than domestic environments that are connected to a low-voltage power-supply network that supplies buildings used for domestic purposes. In a domestic environment this product may cause radio interference in which case the user may be required to take adequate measures.

-
- 4 *EVM Use Restrictions and Warnings:*
 - 4.1 EVMS ARE NOT FOR USE IN FUNCTIONAL SAFETY AND/OR SAFETY CRITICAL EVALUATIONS, INCLUDING BUT NOT LIMITED TO EVALUATIONS OF LIFE SUPPORT APPLICATIONS.
 - 4.2 User must read and apply the user guide and other available documentation provided by TI regarding the EVM prior to handling or using the EVM, including without limitation any warning or restriction notices. The notices contain important safety information related to, for example, temperatures and voltages.
 - 4.3 *Safety-Related Warnings and Restrictions:*
 - 4.3.1 User shall operate the EVM within TI's recommended specifications and environmental considerations stated in the user guide, other available documentation provided by TI, and any other applicable requirements and employ reasonable and customary safeguards. Exceeding the specified performance ratings and specifications (including but not limited to input and output voltage, current, power, and environmental ranges) for the EVM may cause personal injury or death, or property damage. If there are questions concerning performance ratings and specifications, User should contact a TI field representative prior to connecting interface electronics including input power and intended loads. Any loads applied outside of the specified output range may also result in unintended and/or inaccurate operation and/or possible permanent damage to the EVM and/or interface electronics. Please consult the EVM user guide prior to connecting any load to the EVM output. If there is uncertainty as to the load specification, please contact a TI field representative. During normal operation, even with the inputs and outputs kept within the specified allowable ranges, some circuit components may have elevated case temperatures. These components include but are not limited to linear regulators, switching transistors, pass transistors, current sense resistors, and heat sinks, which can be identified using the information in the associated documentation. When working with the EVM, please be aware that the EVM may become very warm.
 - 4.3.2 EVMs are intended solely for use by technically qualified, professional electronics experts who are familiar with the dangers and application risks associated with handling electrical mechanical components, systems, and subsystems. User assumes all responsibility and liability for proper and safe handling and use of the EVM by User or its employees, affiliates, contractors or designees. User assumes all responsibility and liability to ensure that any interfaces (electronic and/or mechanical) between the EVM and any human body are designed with suitable isolation and means to safely limit accessible leakage currents to minimize the risk of electrical shock hazard. User assumes all responsibility and liability for any improper or unsafe handling or use of the EVM by User or its employees, affiliates, contractors or designees.
 - 4.4 User assumes all responsibility and liability to determine whether the EVM is subject to any applicable international, federal, state, or local laws and regulations related to User's handling and use of the EVM and, if applicable, User assumes all responsibility and liability for compliance in all respects with such laws and regulations. User assumes all responsibility and liability for proper disposal and recycling of the EVM consistent with all applicable international, federal, state, and local requirements.
 5. *Accuracy of Information:* To the extent TI provides information on the availability and function of EVMs, TI attempts to be as accurate as possible. However, TI does not warrant the accuracy of EVM descriptions, EVM availability or other information on its websites as accurate, complete, reliable, current, or error-free.
 6. *Disclaimers:*
 - 6.1 EXCEPT AS SET FORTH ABOVE, EVMS AND ANY MATERIALS PROVIDED WITH THE EVM (INCLUDING, BUT NOT LIMITED TO, REFERENCE DESIGNS AND THE DESIGN OF THE EVM ITSELF) ARE PROVIDED "AS IS" AND "WITH ALL FAULTS." TI DISCLAIMS ALL OTHER WARRANTIES, EXPRESS OR IMPLIED, REGARDING SUCH ITEMS, INCLUDING BUT NOT LIMITED TO ANY EPIDEMIC FAILURE WARRANTY OR IMPLIED WARRANTIES OF MERCHANTABILITY OR FITNESS FOR A PARTICULAR PURPOSE OR NON-INFRINGEMENT OF ANY THIRD PARTY PATENTS, COPYRIGHTS, TRADE SECRETS OR OTHER INTELLECTUAL PROPERTY RIGHTS.
 - 6.2 EXCEPT FOR THE LIMITED RIGHT TO USE THE EVM SET FORTH HEREIN, NOTHING IN THESE TERMS SHALL BE CONSTRUED AS GRANTING OR CONFERRING ANY RIGHTS BY LICENSE, PATENT, OR ANY OTHER INDUSTRIAL OR INTELLECTUAL PROPERTY RIGHT OF TI, ITS SUPPLIERS/LICENSORS OR ANY OTHER THIRD PARTY, TO USE THE EVM IN ANY FINISHED END-USER OR READY-TO-USE FINAL PRODUCT, OR FOR ANY INVENTION, DISCOVERY OR IMPROVEMENT, REGARDLESS OF WHEN MADE, CONCEIVED OR ACQUIRED.
 7. *USER'S INDEMNITY OBLIGATIONS AND REPRESENTATIONS.* USER WILL DEFEND, INDEMNIFY AND HOLD TI, ITS LICENSORS AND THEIR REPRESENTATIVES HARMLESS FROM AND AGAINST ANY AND ALL CLAIMS, DAMAGES, LOSSES, EXPENSES, COSTS AND LIABILITIES (COLLECTIVELY, "CLAIMS") ARISING OUT OF OR IN CONNECTION WITH ANY HANDLING OR USE OF THE EVM THAT IS NOT IN ACCORDANCE WITH THESE TERMS. THIS OBLIGATION SHALL APPLY WHETHER CLAIMS ARISE UNDER STATUTE, REGULATION, OR THE LAW OF TORT, CONTRACT OR ANY OTHER LEGAL THEORY, AND EVEN IF THE EVM FAILS TO PERFORM AS DESCRIBED OR EXPECTED.
-

8. *Limitations on Damages and Liability:*

8.1 *General Limitations.* IN NO EVENT SHALL TI BE LIABLE FOR ANY SPECIAL, COLLATERAL, INDIRECT, PUNITIVE, INCIDENTAL, CONSEQUENTIAL, OR EXEMPLARY DAMAGES IN CONNECTION WITH OR ARISING OUT OF THESE TERMS OR THE USE OF THE EVMS , REGARDLESS OF WHETHER TI HAS BEEN ADVISED OF THE POSSIBILITY OF SUCH DAMAGES. EXCLUDED DAMAGES INCLUDE, BUT ARE NOT LIMITED TO, COST OF REMOVAL OR REINSTALLATION, ANCILLARY COSTS TO THE PROCUREMENT OF SUBSTITUTE GOODS OR SERVICES, RETESTING, OUTSIDE COMPUTER TIME, LABOR COSTS, LOSS OF GOODWILL, LOSS OF PROFITS, LOSS OF SAVINGS, LOSS OF USE, LOSS OF DATA, OR BUSINESS INTERRUPTION. NO CLAIM, SUIT OR ACTION SHALL BE BROUGHT AGAINST TI MORE THAN TWELVE (12) MONTHS AFTER THE EVENT THAT GAVE RISE TO THE CAUSE OF ACTION HAS OCCURRED.

8.2 *Specific Limitations.* IN NO EVENT SHALL TI'S AGGREGATE LIABILITY FROM ANY USE OF AN EVM PROVIDED HEREUNDER, INCLUDING FROM ANY WARRANTY, INDEMNITY OR OTHER OBLIGATION ARISING OUT OF OR IN CONNECTION WITH THESE TERMS, , EXCEED THE TOTAL AMOUNT PAID TO TI BY USER FOR THE PARTICULAR EVM(S) AT ISSUE DURING THE PRIOR TWELVE (12) MONTHS WITH RESPECT TO WHICH LOSSES OR DAMAGES ARE CLAIMED. THE EXISTENCE OF MORE THAN ONE CLAIM SHALL NOT ENLARGE OR EXTEND THIS LIMIT.

9. *Return Policy.* Except as otherwise provided, TI does not offer any refunds, returns, or exchanges. Furthermore, no return of EVM(s) will be accepted if the package has been opened and no return of the EVM(s) will be accepted if they are damaged or otherwise not in a resalable condition. If User feels it has been incorrectly charged for the EVM(s) it ordered or that delivery violates the applicable order, User should contact TI. All refunds will be made in full within thirty (30) working days from the return of the components(s), excluding any postage or packaging costs.

10. *Governing Law:* These terms and conditions shall be governed by and interpreted in accordance with the laws of the State of Texas, without reference to conflict-of-laws principles. User agrees that non-exclusive jurisdiction for any dispute arising out of or relating to these terms and conditions lies within courts located in the State of Texas and consents to venue in Dallas County, Texas. Notwithstanding the foregoing, any judgment may be enforced in any United States or foreign court, and TI may seek injunctive relief in any United States or foreign court.

Mailing Address: Texas Instruments, Post Office Box 655303, Dallas, Texas 75265
Copyright © 2023, Texas Instruments Incorporated

IMPORTANT NOTICE AND DISCLAIMER

TI PROVIDES TECHNICAL AND RELIABILITY DATA (INCLUDING DATA SHEETS), DESIGN RESOURCES (INCLUDING REFERENCE DESIGNS), APPLICATION OR OTHER DESIGN ADVICE, WEB TOOLS, SAFETY INFORMATION, AND OTHER RESOURCES "AS IS" AND WITH ALL FAULTS, AND DISCLAIMS ALL WARRANTIES, EXPRESS AND IMPLIED, INCLUDING WITHOUT LIMITATION ANY IMPLIED WARRANTIES OF MERCHANTABILITY, FITNESS FOR A PARTICULAR PURPOSE OR NON-INFRINGEMENT OF THIRD PARTY INTELLECTUAL PROPERTY RIGHTS.

These resources are intended for skilled developers designing with TI products. You are solely responsible for (1) selecting the appropriate TI products for your application, (2) designing, validating and testing your application, and (3) ensuring your application meets applicable standards, and any other safety, security, regulatory or other requirements.

These resources are subject to change without notice. TI grants you permission to use these resources only for development of an application that uses the TI products described in the resource. Other reproduction and display of these resources is prohibited. No license is granted to any other TI intellectual property right or to any third party intellectual property right. TI disclaims responsibility for, and you will fully indemnify TI and its representatives against, any claims, damages, costs, losses, and liabilities arising out of your use of these resources.

TI's products are provided subject to [TI's Terms of Sale](#) or other applicable terms available either on [ti.com](https://www.ti.com) or provided in conjunction with such TI products. TI's provision of these resources does not expand or otherwise alter TI's applicable warranties or warranty disclaimers for TI products.

TI objects to and rejects any additional or different terms you may have proposed.

Mailing Address: Texas Instruments, Post Office Box 655303, Dallas, Texas 75265
Copyright © 2023, Texas Instruments Incorporated