

# Half-Wave Rectifier Circuit With MSP430 Smart Analog Combo



Matthew Calvo

## Design Goals

Input		Output		Supply	
$V_{iMin}$	$V_{iMax}$	$V_{oMin}$	$V_{oMax}$	$V_{cc}$	$V_{ee}$
$0.2V_{pp}$	$2V_{pp}$	$0.1V_p$	$1V_p$	3.3V	0V

## Design Description

Some MSP430™ microcontrollers (MCUs) contain configurable integrated signal chain elements such as op-amps, DACs, and programmable gain stages. These elements make up a peripheral called the Smart Analog Combo (SAC). For information on the different types of SACs and how to leverage the configurable analog signal chain capabilities, visit [MSP430 MCUs Smart Analog Combo Training](#). To get started with your design, download the [Half-Wave Rectifier Circuit Design Files](#).

The precision half-wave rectifier inverts and transfers only the negative-half input of a time varying input signal (preferably sinusoidal) to the output. This circuit uses the [MSP430FR2311](#) SAC\_L1 op-amp in an inverting amplifier configuration with the appropriate diodes in place. There is room for further integration by using the integrated DAC in the [MSP430FR2355](#) SAC\_L3 block to provide the bias voltage on the non-inverting op-amp terminal. By appropriately selecting the feedback resistor values, different gains can be achieved. Precision half-wave rectifiers are commonly used with other op amp circuits such as a peak-detector or bandwidth limited non-inverting amplifier to produce a DC output voltage. The output of the SAC\_L3 op-amp can be cascaded with the other 3 SAC\_L3 blocks in the MSP430FR2355 to expand upon the analog signal chain functionality or sampled directly by the onboard ADC or monitored by the onboard comparator for further processing inside the MCU. This configuration has been designed to work for sinusoidal input signals between  $0.2V_{pp}$  and  $2V_{pp}$  at frequencies up to 50kHz.

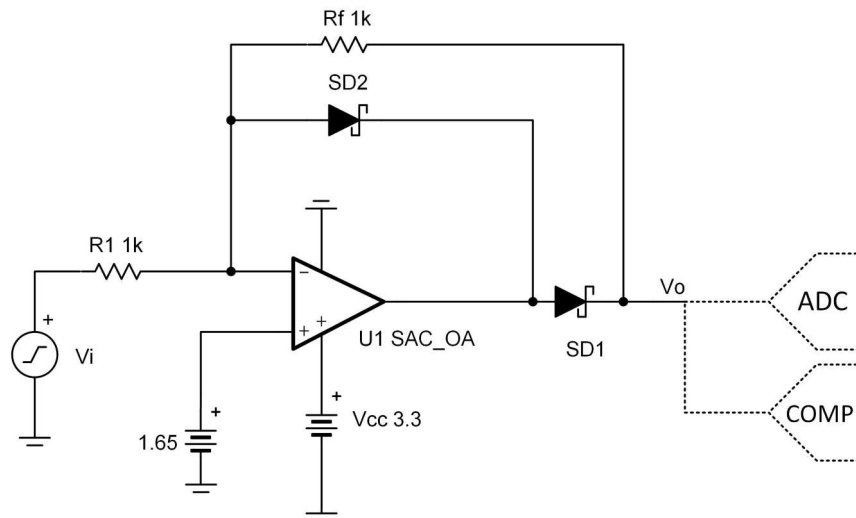

## Design Notes

- Set output range based on linear output swing (see  $A_{o1}$  specification).
- Use fast switching diodes. High-frequency input signals will be distorted depending on the speed by which the diodes can transition from blocking to forward conducting mode. Schottky diodes can be a preferable choice, since these have faster transitions than pn-junction diodes at the expense of higher reverse leakage.
- The resistor tolerance sets the circuit gain error.
- Minimize noise errors by selecting low-value resistors.
- If the fix is implemented using the MSP430FR2311, the circuit can be realized by the SAC\_L1 op-amp in general purpose mode or the Transimpedance Amplifier (TIA). In both cases the bias voltage can be set using a resistor divider or external DAC.
- If the TIA op-amp is used, the input voltage would need to be kept below  $V_{CC}/2$  to operate within the peripheral's common-mode input specifications.
- If the fix is implemented using the MSP430FR2355, the circuit can be realized using any of the 4 on-board SAC\_L3 peripherals in DAC mode in order to generate the bias voltage on the non-inverting op-amp terminal.
- When the input signal changes polarities, the amplifier output must slew two diode voltage drops. The MSP430 SAC and TIA op-amps can be configured in "High-Speed Mode" to achieve a higher slew rate.
- The [Half-Wave Rectifier Circuit Design Files](#) include code examples showing how to properly initialize the SAC peripherals.

## Design Steps

1. Set the desired gain of the half-wave rectifier to select the feedback resistors.

$$V_o = \text{Gain} \times V_i$$

$$\text{Gain} = -\frac{R_f}{R_1} = -1$$

$$R_f = R_1 = 2 \times R_{eq}$$

- Where  $R_{eq}$  is the parallel combination of  $R_1$  and  $R_f$
2. Select the resistors such that the resistor noise is negligible compared to the voltage broadband noise of the op amp.

$$E_{nr} = \sqrt{4 \times k_b \times T \times R_{eq}}$$

$$R_{eq} \leq \frac{E_{nbb}^2}{4 \times k_b \times T \times 3^2} = (E_{nbb})$$

$$= 20 \frac{\text{nV}}{\sqrt{\text{Hz}}} = \frac{(20 \times 10^{-9})^2}{4 \times 1.381 \times 10^{-23} \times 298 \times 3^2} = 2.7 \text{ k}\Omega$$

$$R_f = R_1 \leq 5.4 \text{ k}\Omega \rightarrow 1 \text{ k}\Omega \text{ (Standard Value)}$$

## Design Simulations

### DC Simulation Results

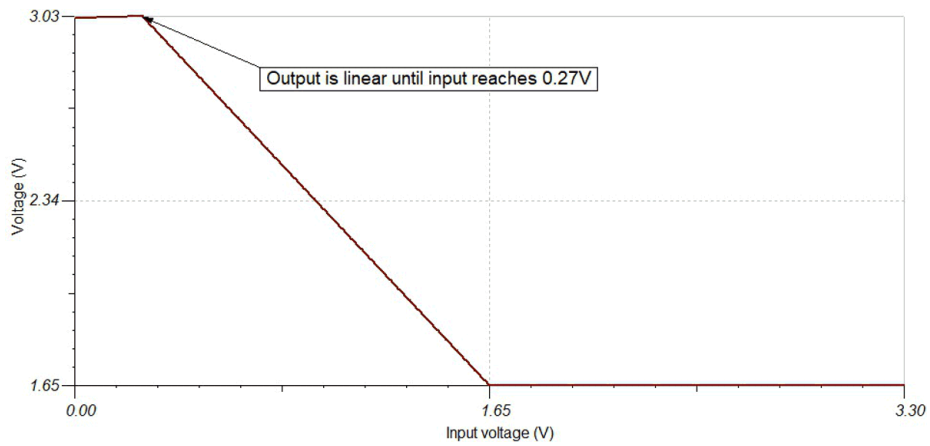

### Transient Simulation Results

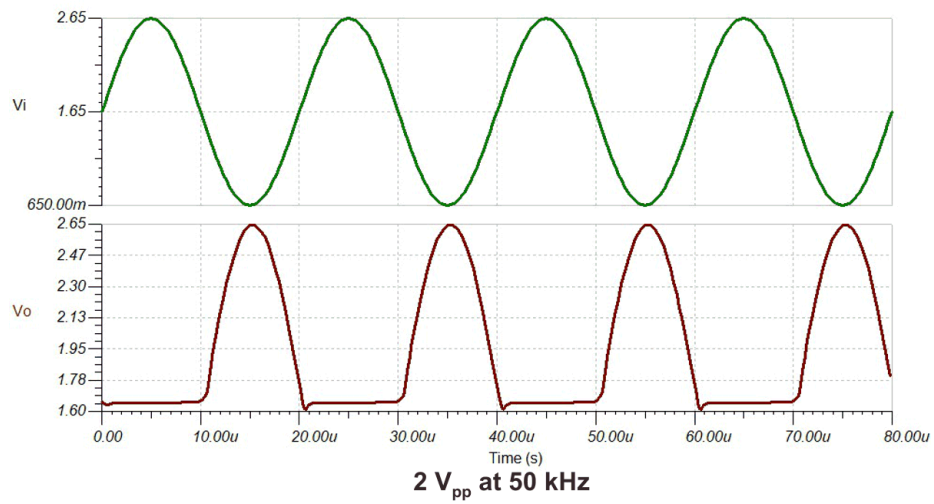
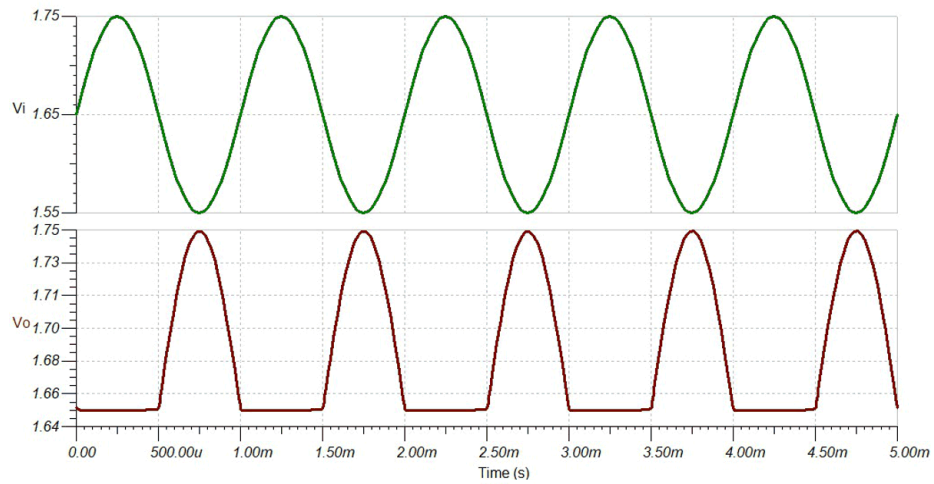

### Target Applications

- [Battery charger](#)
- [Waveform generator](#)

## References

1. Texas Instruments, [MSP430 Half-Wave Rectifier Circuit](#), design file
2. Texas Instruments, [MSP430 MCUs Smart Analog Combo Training](#), video





## Design Featured Op Amp

MSP430FRxx Smart Analog Combo		
	MSP430FR2311 SAC_L1	MSP430FR2355 SAC_L3
$V_{CC}$	2.0V to 3.6V	
$V_{CM}$	-0.1V to $V_{CC} + 0.1V$	
$V_{out}$	Rail-to-rail	
$V_{os}$	$\pm 5mV$	
$A_{OL}$	100dB	
$I_q$	350 $\mu A$ (high-speed mode)	
	120 $\mu A$ (low-power mode)	
$I_b$	50pA	
UGBW	4MHz (high-speed mode)	2.8MHz (high-speed mode)
	1.4MHz (low-power mode)	1MHz (low-power mode)
SR	3V/ $\mu s$ (high-speed mode)	
	1V/ $\mu s$ (low-power mode)	
Number of channels	1	4
<a href="#">MSP430FR2311</a>		
<a href="#">MSP430FR2355</a>		

## Design Alternate Op Amp

MSP430FR2311 Transimpedance Amplifier	
$V_{CC}$	2.0V to 3.6V
$V_{CM}$	-0.1V to $V_{CC}/2V$
$V_{out}$	Rail-to-rail
$V_{os}$	$\pm 5mV$
$A_{OL}$	100dB
$I_q$	350 $\mu A$ (high-speed mode)
	120 $\mu A$ (low-power mode)
$I_b$	5pA (TSSOP-16 with OA-dedicated pin input)
	50pA (TSSOP-20 and VQFN-16)
UGBW	5MHz (high-speed mode)
	1.8MHz (low-power mode)
SR	4V/ $\mu s$ (high-speed mode)
	1V/ $\mu s$ (low-power mode)
Number of channels	1
<a href="#">MSP430FR2311</a>	

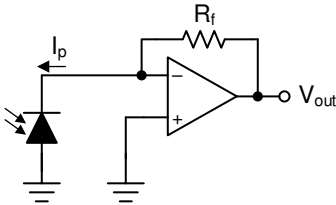
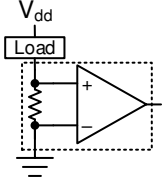
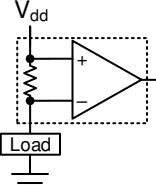
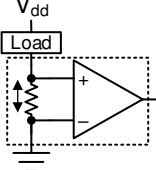
**Related MSP430 Circuits**

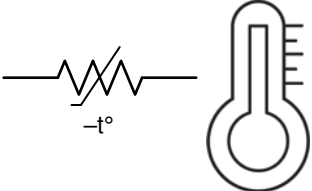
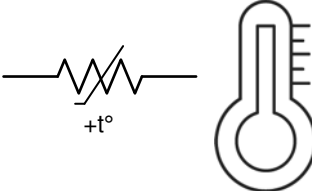
<p>Low-noise and long-range PIR sensor conditioner circuit</p> 	<p>Bridge amplifier circuit</p> 	<p>Transimpedance amplifier circuit</p> 
<p>Single-supply, low-side, unidirectional current-sensing circuit</p> 	<p>High-side current sensing with discrete difference amplifier circuit</p> 	<p>Low-side, bidirectional current-sensing circuit</p> 
<p>Half-wave rectifier circuit</p> 	<p>Temperature sensing with NTC thermistor circuit</p> 	<p>Temperature sensing with PTC thermistor circuit</p> 

**Trademarks**

MSP430™ is a trademark of Texas Instruments.  
All trademarks are the property of their respective owners.

**Revision History**

NOTE: Page numbers for previous revisions may differ from page numbers in the current version.

Changes from Revision A (March 2020) to Revision B (October 2024)	Page
• Updated the format for tables, figures, and cross-references throughout the document.....	1

Changes from Revision * (December 2019) to Revision A (March 2020)	Page
• Added <i>Related MSP430 Circuits</i> section.....	1

## IMPORTANT NOTICE AND DISCLAIMER

TI PROVIDES TECHNICAL AND RELIABILITY DATA (INCLUDING DATA SHEETS), DESIGN RESOURCES (INCLUDING REFERENCE DESIGNS), APPLICATION OR OTHER DESIGN ADVICE, WEB TOOLS, SAFETY INFORMATION, AND OTHER RESOURCES "AS IS" AND WITH ALL FAULTS, AND DISCLAIMS ALL WARRANTIES, EXPRESS AND IMPLIED, INCLUDING WITHOUT LIMITATION ANY IMPLIED WARRANTIES OF MERCHANTABILITY, FITNESS FOR A PARTICULAR PURPOSE OR NON-INFRINGEMENT OF THIRD PARTY INTELLECTUAL PROPERTY RIGHTS.

These resources are intended for skilled developers designing with TI products. You are solely responsible for (1) selecting the appropriate TI products for your application, (2) designing, validating and testing your application, and (3) ensuring your application meets applicable standards, and any other safety, security, regulatory or other requirements.

These resources are subject to change without notice. TI grants you permission to use these resources only for development of an application that uses the TI products described in the resource. Other reproduction and display of these resources is prohibited. No license is granted to any other TI intellectual property right or to any third party intellectual property right. TI disclaims responsibility for, and you will fully indemnify TI and its representatives against, any claims, damages, costs, losses, and liabilities arising out of your use of these resources.

TI's products are provided subject to [TI's Terms of Sale](#) or other applicable terms available either on [ti.com](https://www.ti.com) or provided in conjunction with such TI products. TI's provision of these resources does not expand or otherwise alter TI's applicable warranties or warranty disclaimers for TI products.

TI objects to and rejects any additional or different terms you may have proposed.

Mailing Address: Texas Instruments, Post Office Box 655303, Dallas, Texas 75265  
Copyright © 2024, Texas Instruments Incorporated