



ABSTRACT

This report covers the radiation characterization results of the SN54SC8T138-SEP, radiation tolerant 3-line to 8-line decoder/demultiplexer with logic level shifter. The study was done to determine Total Ionizing Dose (TID) effects under high dose rate (HDR) up to 50krad(Si) as a one time characterization. The results show that all samples passed within the specified limits up to 30krad(Si) (with 72 hour room temperature anneal). Radiation Lot Acceptance Testing (RLAT) is performed using 5 units at a dose level of 30krad(Si) for future wafer lots per MIL-STD-883 TM 1019. All future wafer lots are tested under the same conditions. The device is manufactured in pure CMOS process. HDR TID response is the worst case. TID HDR characterization was performed per TM 1019.

The SN54SC8T138-SEP is packaged in a space enhanced plastic package for low outgassing characteristics and is Single Event Latch-Up (SEL) immune up to 50MeV-cm²/mg, which makes the device an option for low Earth orbit space applications. Single Event Transient (SET) data is also provided in the Single Event Effects Radiation Report.

The SN54SC8T138-SEP Total Ionizing Dose (TID) Report covers the TID performance of all devices listed below. The SN54SC8T138-SEP device covers all functional blocks and active die area of the other devices, which is why the device was selected for single-event effect testing for this group of devices.

- **SN54SC8T138-SEP**
- SN54SC8T139-SEP
- SN54SC8T151-SEP
- SN54SC8T157-SEP

Table of Contents

1 Device Information	2
1.1 Device Details.....	2
2 Total Dose Test Setup	3
2.1 Test Overview.....	3
2.2 Test Description and Facilities.....	3
2.3 Test Setup Details.....	3
2.4 Test Configuration and Condition.....	4
3 TID Characterization Test Results	5
3.1 TID Characterization Summary Results.....	5
3.2 Specification Compliance Matrix.....	6
4 Reference Documents	7
5 Appendix: HDR TID Report Data	7

List of Figures

Figure 2-1. SN54SC8T138-SEP Bias Diagram.....	3
---	---

List of Tables

Table 1-1. Device and Exposure Details.....	2
Table 2-1. HDR Device Information.....	4
Table 3-1. Electrical Parameters Table.....	6

Trademarks

All trademarks are the property of their respective owners.

1 Device Information

The SN54SC8T138-SEP is a three to eight decoder with one standard output strobe (G2) and two active low output strobes (G 1 and G 0). When the outputs are gated by any of the strobe inputs, they are all forced into the high state. When the outputs are not disabled by the strobe inputs, only the selected output is low while all others are high. The output level is referenced to the supply voltage (VCC) and supports 1.8-V, 2.5-V, 3.3-V, and 5-V CMOS levels.

The input is designed with a lower threshold circuit to support up translation for lower voltage CMOS inputs (for example, 1.2 V input to 1.8 V output or 1.8 V input to 3.3 V output). In addition, the 5-V tolerant input pins enable down translation (for example, 3.3 V to 2.5 V output).

1.1 Device Details

[Table 1-1](#) lists the device information used for TID HDR characterization and qualification.

Table 1-1. Device and Exposure Details

TID HDR Details: Up To 50krad(Si)	
TI Device Number	SN54SC8T138-SEP
VID Number	V62/25622
Package	16-pin PW (TSSOP)
Technology	LBC9
Die Lot Number	3272255RFB
A/T Lot Number and Date Code	4088878ML4 / 41C75DK
Quantity Tested	21 irradiated devices + 4 control
Lot Accept or Reject	Devices passed 30krad(Si)
HDR Radiation Facility	Texas Instruments CLAB in Dallas, Texas
HDR Dose Level	10krad(Si), 20krad(Si), 30krad(Si), 50krad(Si)
HDR Dose Rate	182.92rad(Si)/s ionizing radiation
Effective Dose Rate 30krad(Si) with 72 hour Anneal	115.74mrad(Si)/s ionizing radiation
HDR Radiation Source	Gammacell 220 Excel (GC-220E) Co-60
Irradiation Temperature	Ambient, room temperature

2 Total Dose Test Setup

2.1 Test Overview

The SN54SC8T138-SEP samples were irradiated at a high dose rate of 182.92rad(Si)/s up to 50krad(Si) (115.74mrad(Si)/s effective does rate for 30krad(Si) with 72 hour anneal) and then put through full electrical parametric testing on the production Automated Test Equipment (ATE). The samples were functional and passed all electrical parametric tests with readings within data sheet electrical specification limits.

2.2 Test Description and Facilities

The SN54SC8T138-SEP HDR exposure was performed on biased devices in a Co-60 gamma cell at TI facility in Dallas, Texas. The un-attenuated dose rate of this cell is 182.92rads(Si)/s (115.74mrad(Si)/s effective does rate of 30krad(Si) with 72 hour anneal). After exposure, the devices were packed in dry ice (per MIL-STD-883 Method 1019.9 section 3.10) and full post radiation electrical evaluation using Texas Instruments ATE was conducted. ATE test limits are set per data sheet electrical limits based on qualification and characterization data. Post radiation measurements were taken within 30 minutes of removing the devices from the dry ice container. The devices were allowed to reach room temperature prior to electrical post radiation measurements.

2.3 Test Setup Details

The devices were tested in biased conditions as described in the following sections.

2.3.1 Bias Diagram

Figure 2-1 shows the bias conditions for each pin during irradiation.

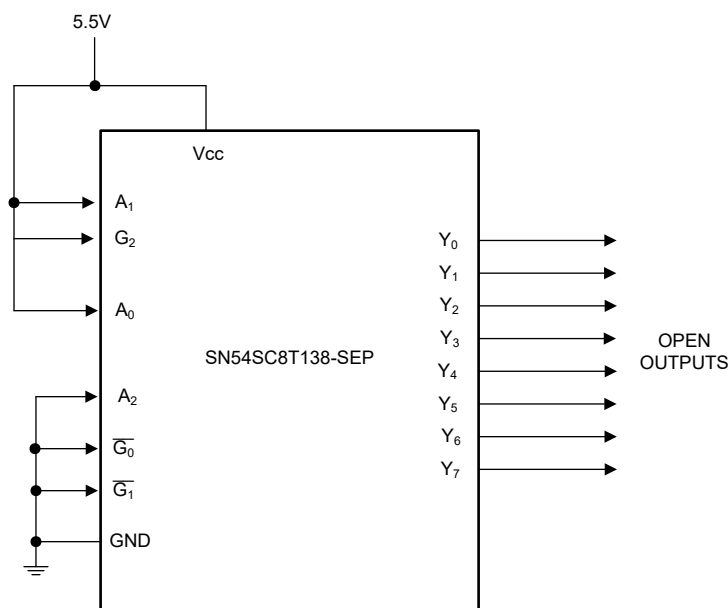

Figure 2-1. SN54SC8T138-SEP Bias Diagram

2.4 Test Configuration and Condition

A step stress (10k, 20k, 30k and 50k) test method was used to determine the TID hardness level. That is, after a predetermined TID level was reached, an electrical test was performed on a given sample of parts to verify that the units are within specified data sheet electrical test limits. The HDR RLAT units were irradiated to 30krad(Si), parametrically tested on ATE, and then were annealed at 25°C for 72 hours. The units that were irradiated to 30krad(Si) and were annealed for 72 hours are denoted as 31krad(Si) in [Section 5](#). ATE parametric testing was completed before and after the anneal.

[Table 2-1](#) lists the serialized samples used for TID characterization.

Table 2-1. HDR Device Information

Control Group	HDR Dose Rate = 182.92rad(Si)/s Effective Dose Rate (30krad + Anneal 72 hours) = 115.74mrad(Si)/s				
	Total Samples: 21 Biased				
Total Samples: 4	Exposure Levels				
0krad (Si)	10krad (Si)	20krad(Si)	30krad(Si)		50krad (Si)
Biased	Biased	Biased	Biased	Biased + 72 hour anneal	Biased
1 - 4	5 - 9	10 - 14	15 - 20	15a - 20a	21 - 25

3 TID Characterization Test Results

3.1 TID Characterization Summary Results

The parametric data for the SN54SC8T138-SEP passes up to 30krad(Si) (with 72 hour room temperature anneal) HDR TID irradiation. The drifts of the electrical parameters through HDR were within the data sheet limits.

Overall, the SN54SC8T138-SEP showed a strong degree of hardness to HDR TID irradiation up to 30krad(Si). The measurements taken post-irradiation for each sample set showed a marginal shift for most parameters at each dose level. The parameters that did show a greater degree of change between pre- and post-irradiation were still within the electrical performance characteristics specified in the data sheet electrical parameters. For the data sheet electrical parameters and associated tests, see [SN54SC8T138-SEP Radiation Tolerant, 3-line to 8-line Decoder/Demultiplexer With Logic Level Shifter](#).

See [Section 5](#) for HDR report up to 50 krad(Si).

3.2 Specification Compliance Matrix

Table 3-1. Electrical Parameters Table

Parameter	Test Conditions	V _{CC}	T _A = -55°C to +125°C			Unit	Test Name
			MIN	TYP	MAX		
V _{T+} 1	Positive-going input threshold voltage	1.2V to 1.3V	0.31	0.655	1.1	V	VTP_1P2V
		1.65V to 2V	0.39	0.915	1.32		VTP_1P65V
		2.25V to 2.75V	0.51	1.09	1.51		VTP_2P25V
		3V to 3.6V	0.65	1.2	1.7		VTP_3V
		4.5V to 5.5V	0.87	1.51	2.16		VTP_4P5V, VTP_5P5V
V _{T-} 1	Negative-going input threshold voltage	1.2V to 1.3V	0.11	0.349	0.60	V	VTN_1P2V
		1.65V to 2V	0.18	0.455	0.63		VTN_1P65V
		2.25V to 2.75V	0.25	0.545	0.74		VTN_2P25V
		3V to 3.6V	0.33	0.635	0.85		VTN_3V
		4.5V to 5.5V	0.45	0.755	1.14		VTN_4P5V, VTN_5P5V
ΔV _T 1	Hysteresis (V _{T+} – V _{T-})	1.2V to 1.3V	0.2	0.29	0.77	V	DELTAVT_1P2V
		1.65V to 2V	0.21	0.43	0.88		DELTAVT_1P65V
		2.25V to 2.75V	0.25	0.54	0.91		DELTAVT_2P25V
		3V to 3.6V	0.31	0.63	0.91		DELTAVT_3V
		4.5V to 5.5V	0.43	0.75	1.05		DELTAVT_4P5V, DELTAVT_5P5V
V _{IH}	High-level input voltage	1.2V to 1.3V	0.78			V	VIH_1P2V
		1.65V to 2V	1.1				VIH_1P65V
		2.25V to 2.75V	1.28				VIH_2P25V
		3V to 3.6V	1.45				VIH_3V
		4.5V to 5.5V	2				VIH_4P5V, VIH_5P5V
V _{IL}	Low-Level input voltage	1.2V to 1.3V			0.18	V	VIL_1P2V
		1.65V to 2V			0.5		VIL_1P65V
		2.25V to 2.75V			0.65		VIL_2P25V
		3V to 3.6V			0.75		VIL_3V
		4.5V to 5.5V			0.85		VIL_4P5V, VIL_5P5V
V _{OH} 2	I _{OH} = -50μA	1.2V to 5.5V	V _{CC} -0.2			V	VOH_N50UA_1P2V, VOH_N50UA_5P5V
	I _{OH} = -1mA	1.2V	0.8				VOH_N1MA_1P2V
	I _{OH} = -2mA	1.65V to 2V	1.21				VOH_N2MA_1P65V
	I _{OH} = -3mA	2.25V to 2.75V	1.93				VOH_N3MA_2P25V
	I _{OH} = -5.5mA	3V to 3.6V	2.49				VOH_N5P5MA_3V
	I _{OH} = -8mA	4.5V to 5.5V	3.95				VOH_N8MA_4P5V
	I _{OH} = -24mA	4.5V to 5.5V	3.15				VOH_N24MA_5P5V
V _{OL}	I _{OL} = 50μA	1.2V to 5.5V			0.1	V	VOL_50UA_1P2V, VOL_50UA_5P5V
	I _{OL} = 1mA	1.2V			0.2		VOL_1MA_1P2V
	I _{OL} = 2mA	1.65V to 2V			0.25		VOL_2MA_1P65V
	I _{OL} = 3mA	2.25V to 2.75V			0.2		VOL_3MA_2P25V
	I _{OL} = 5.5mA	3V to 3.6V			0.25		VOL_5P5MA_3V
	I _{OL} = 8mA	4.5V to 5.5V			0.35		VOL_8MA_4P5V
	I _{OL} = 24mA	4.5V to 5.5V			0.75		VOL_24MA_5P5V
I _{CC}	V _I = V _{CC} or GND, I _O = 0	1.2V to 5.5V		2	220	μA	ICC_5P5V
ΔI _{CC}	One input at 0.3V or 3.4V, other inputs at V _{CC} or GND	5.5V			1.5	mA	DELTAICC_5P5V
	One input at 0.3V or 1.1V, other inputs at V _{CC} or GND	1.8V			68	μA	DELTAICC_1P8V
I _{OZ} 3	V _O = V _{CC} or GND	5.5V			±26	μA	IOZ_5P5V
I _I	V _I = 0V to V _{CC}	V _I = 0V to V _{CC}			±1	μA	II_5P5V

- Schmitt-trigger input devices only.
- Push-pull output devices only.
- 3-State output devices only.

4 Reference Documents

Texas Instruments total ionizing dose radiation (total dose) test procedure follows the standards put forth in MIL-STD-883 TM 1019. The document can be found at the DLA website.

5 Appendix: HDR TID Report Data

This appendix provides the SN54SC8T138-SEP TID HDR report. The report shows the variation for each parameter up to 50krad(Si).

TID Report SN54SC8T138-SEP

		DELTAICC_1P8V					
		Units		μA			
		Max Limit		68			
		Min Limit		-1			
krad	Serial #	PreTestHDR	PostTestHDR	Delta	Delta %	% of Limit Range	
0	1	2.935	2.973	0.04	1.29%	0.06%	
0	2	2.967	2.817	-0.15	-5.06%	0.22%	
0	3	3.029	2.754	-0.28	-9.08%	0.40%	
0	4	2.779	2.973	0.19	6.98%	0.28%	
10	5	2.998	2.723	-0.28	-9.17%	0.40%	
10	6	2.904	3.036	0.13	4.55%	0.19%	
10	7	2.935	2.848	-0.09	-2.96%	0.13%	
10	8	2.873	2.848	-0.02	-0.87%	0.04%	
10	9	3.060	3.005	-0.06	-1.80%	0.08%	
20	10	3.185	2.723	-0.46	-14.51%	0.67%	
20	11	3.248	2.660	-0.59	-18.10%	0.85%	
20	12	2.779	2.316	-0.46	-16.66%	0.67%	
20	13	3.216	2.879	-0.34	-10.48%	0.49%	
20	14	3.029	2.911	-0.12	-3.90%	0.17%	
30	15	2.904	3.005	0.10	3.48%	0.15%	
30	16	3.029	3.098	0.07	2.28%	0.10%	
30	17	3.060	3.224	0.16	5.36%	0.24%	
30	18	2.748	2.566	-0.18	-6.62%	0.26%	
30	19	3.060	3.192	0.13	4.31%	0.19%	
30	20	3.029	3.255	0.23	7.46%	0.33%	
31	15a	2.904	2.942	0.04	1.31%	0.06%	
31	16a	3.029	2.817	-0.21	-7.00%	0.31%	
31	17a	3.060	2.566	-0.49	-16.14%	0.72%	
31	18a	2.748	2.504	-0.24	-8.88%	0.35%	
31	19a	3.060	2.504	-0.56	-18.17%	0.81%	
31	20a	3.029	2.785	-0.24	-8.06%	0.35%	
50	21	2.935	3.912	0.98	33.29%	1.42%	
50	22	3.216	4.256	1.04	32.34%	1.51%	
50	23	2.779	3.693	0.91	32.89%	1.32%	
50	24	3.310	3.943	0.63	19.12%	0.92%	
50	25	3.154	4.319	1.17	36.94%	1.69%	
Max		3.310	4.256	0.95	33.29%	1.51%	
Average		2.995	2.991	0.00	-0.09%	0.46%	
Min		2.748	2.316	-0.43	-18.17%	0.04%	
Std Dev		0.148	0.447	0.30	14.10%	0.41%	

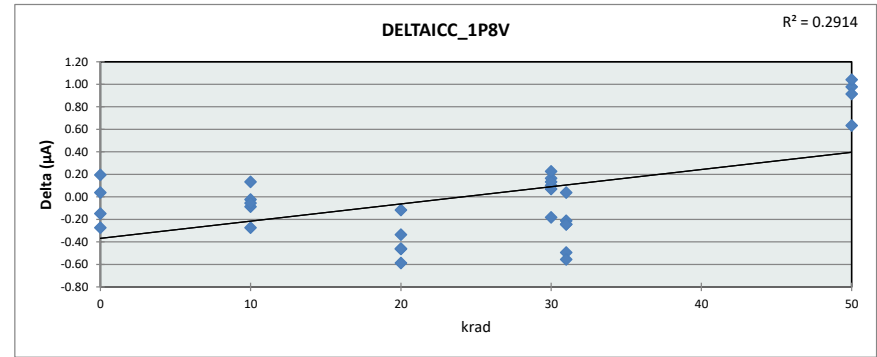

		DELTAICC_1P8V					
		Units		μA			
		Max Limit		68			
		Min Limit		-1			
krad		0	10	20	30	31	50
LL		-1.000	-1.000	-1.000	-1.000	-1.000	-1.000
Min		2.754	2.723	2.316	2.566	2.504	3.693
Average		2.879	2.892	2.698	3.057	2.686	4.025
Max		2.973	3.036	2.911	3.255	2.942	4.319
UL		68.000	68.000	68.000	68.000	68.000	68.000

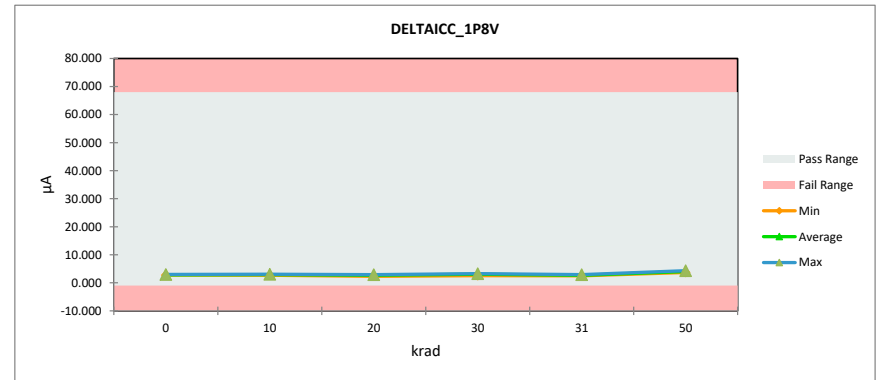

TID Report SN54SC8T138-SEP

DELTAICC_5P5V						
Units	μA					
Max Limit	1500					
Min Limit	-1					
krad	Serial #	PreTestHDR	PostTestHDR	Delta	Delta %	% of Limit Range
0	1	92.030	91.790	-0.24	-0.26%	0.02%
0	2	91.120	91.070	-0.05	-0.05%	0.00%
0	3	91.500	90.950	-0.55	-0.60%	0.04%
0	4	91.030	91.140	0.11	0.12%	0.01%
10	5	91.120	90.480	-0.64	-0.70%	0.04%
10	6	91.310	90.790	-0.52	-0.57%	0.03%
10	7	91.560	90.420	-1.14	-1.25%	0.08%
10	8	91.220	90.350	-0.87	-0.95%	0.06%
10	9	90.900	90.100	-0.80	-0.88%	0.05%
20	10	90.840	90.290	-0.55	-0.61%	0.04%
20	11	91.000	89.890	-1.11	-1.22%	0.07%
20	12	90.590	89.630	-0.96	-1.06%	0.06%
20	13	91.590	90.610	-0.98	-1.07%	0.07%
20	14	91.560	90.230	-1.33	-1.45%	0.09%
30	15	91.590	91.700	0.11	0.12%	0.01%
30	16	91.400	91.700	0.30	0.33%	0.02%
30	17	91.500	91.320	-0.18	-0.20%	0.01%
30	18	91.310	91.200	-0.11	-0.12%	0.01%
30	19	90.780	91.540	0.76	0.84%	0.05%
30	20	92.000	91.540	-0.46	-0.50%	0.03%
31	15a	91.590	89.540	-2.05	-2.24%	0.14%
31	16a	91.400	90.290	-1.11	-1.21%	0.07%
31	17a	91.500	90.100	-1.40	-1.53%	0.09%
31	18a	91.310	89.170	-2.14	-2.34%	0.14%
31	19a	90.780	89.290	-1.49	-1.64%	0.10%
31	20a	92.000	90.040	-1.96	-2.13%	0.13%
50	21	91.120	93.520	2.40	2.63%	0.16%
50	22	91.720	94.080	2.36	2.57%	0.16%
50	23	91.310	92.890	1.58	1.73%	0.11%
50	24	91.400	93.300	1.90	2.08%	0.13%
50	25	92.030	93.140	1.11	1.21%	0.07%
	Max	92.030	94.080	2.05	2.63%	0.16%
	Average	91.336	90.965	-0.37	-0.41%	0.07%
	Min	90.590	89.170	-1.42	-2.34%	0.00%
	Std Dev	0.365	1.230	0.87	1.30%	0.05%

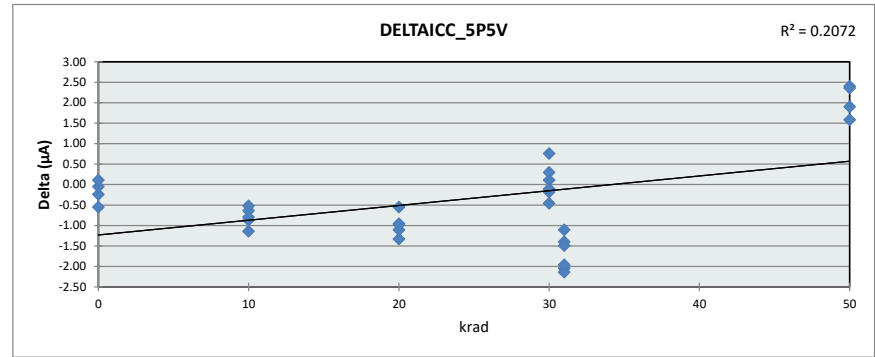

DELTAICC_5P5V						
Units	μA					
Max Limit	1500					
Min Limit	-1					
krad	0	10	20	30	31	50
LL	-1.000	-1.000	-1.000	-1.000	-1.000	-1.000
Min	90.950	90.100	89.630	91.200	89.170	92.890
Average	91.238	90.428	90.130	91.500	89.738	93.386
Max	91.790	90.790	90.610	91.700	90.290	94.080
UL	1500.000	1500.000	1500.000	1500.000	1500.000	1500.000

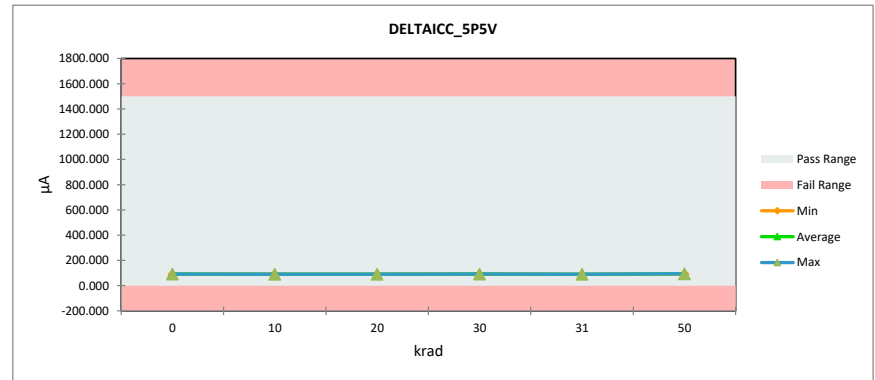

TID Report SN54SC8T138-SEP

		ICC				
		μA				
		220				
		-0.1				
krad	Serial #	PreTestHDR	PostTestHDR	Delta	Delta %	% of Limit Range
0	1	0.054	0.028	-0.03	-48.25%	0.01%
0	2	0.054	0.032	-0.02	-41.19%	0.01%
0	3	0.049	0.041	-0.01	-15.73%	0.00%
0	4	0.052	0.027	-0.03	-48.77%	0.01%
10	5	0.053	0.064	0.01	21.16%	0.01%
10	6	0.049	0.099	0.05	103.85%	0.02%
10	7	0.057	0.073	0.02	29.18%	0.01%
10	8	0.051	0.076	0.02	46.86%	0.01%
10	9	0.047	0.081	0.03	71.25%	0.02%
20	10	0.053	16.170	16.12	30577.29%	7.32%
20	11	0.050	19.630	19.58	39254.45%	8.90%
20	12	0.044	17.760	17.72	40633.94%	8.05%
20	13	0.051	16.600	16.55	32764.78%	7.52%
20	14	0.048	14.440	14.39	30185.23%	6.54%
30	15	0.048	221.500	221.45	464455.37%	100.61%
30	16	0.046	218.300	218.25	470070.15%	99.16%
30	17	0.040	235.200	235.16	585703.24%	106.84%
30	18	0.046	236.200	236.15	508622.81%	107.29%
30	19	0.041	257.900	257.86	627546.63%	117.16%
30	20	0.049	228.500	228.45	466798.24%	103.79%
31	15a	0.048	24.030	23.98	50298.49%	10.90%
31	16a	0.046	27.520	27.47	59172.02%	12.48%
31	17a	0.040	32.740	32.70	81444.21%	14.86%
31	18a	0.046	28.600	28.55	61498.10%	12.97%
31	19a	0.041	32.240	32.20	78361.91%	14.63%
31	20a	0.049	30.300	30.25	61812.55%	13.74%
50	21	0.056	1387.000	1386.94	2455636.54%	630.14%
50	22	0.048	1415.000	1414.95	2967601.34%	642.87%
50	23	0.043	1411.000	1410.96	3283586.29%	641.05%
50	24	0.041	1374.000	1373.96	3318740.58%	624.24%
50	25	0.048	1367.000	1366.95	2829541.90%	621.06%
	Max	0.057	1415.000	1414.94	3318740.58%	642.87%
	Average	0.048	241.505	241.46	523829.42%	109.71%
	Min	0.040	0.027	-0.01	-48.77%	0.00%
	Std Dev	0.005	469.344	469.34	1018510.30%	213.24%

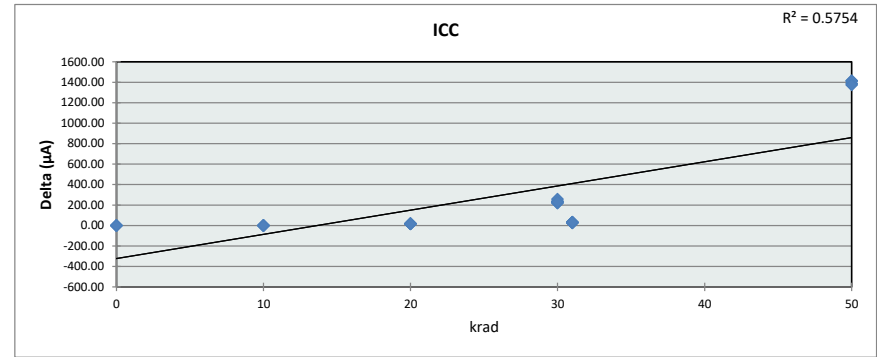

		ICC				
		μA				
		220				
		-0.1				
krad	0	10	20	30	31	50
LL	-0.100	-0.100	-0.100	-0.100	-0.100	-0.100
Min	0.027	0.064	14.440	218.300	24.030	1367.000
Average	0.032	0.079	16.920	232.933	29.238	1390.800
Max	0.041	0.099	19.630	257.900	32.740	1415.000
UL	220.000	220.000	220.000	220.000	220.000	220.000

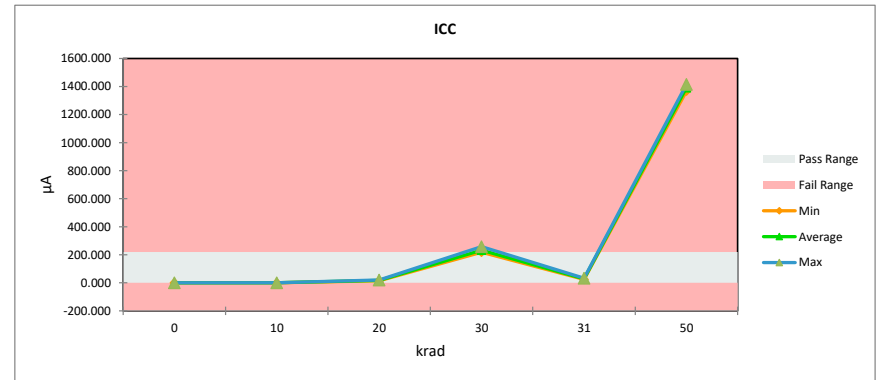

TID Report

SN54SC8T138-SEP

II_5P5V						
		Units				
		μA				
		Max Limit				
		1				
		Min Limit				
		-1				
krad	Serial #	PreTestHDR	PostTestHDR	Delta	Delta %	% of Limit Range
0	1	0.002	0.008	0.01	249.98%	0.30%
0	2	0.006	0.009	0.00	46.79%	0.14%
0	3	0.005	0.009	0.00	79.29%	0.21%
0	4	0.003	0.008	0.00	142.81%	0.24%
10	5	0.005	0.006	0.00	12.28%	0.03%
10	6	0.008	0.011	0.00	44.23%	0.17%
10	7	0.007	0.007	0.00	0.31%	0.00%
10	8	0.003	0.008	0.00	163.91%	0.25%
10	9	0.003	0.007	0.00	122.27%	0.19%
20	10	0.010	0.048	0.04	395.58%	1.90%
20	11	0.004	0.020	0.02	456.65%	0.83%
20	12	0.006	0.011	0.01	91.70%	0.27%
20	13	0.004	0.011	0.01	162.03%	0.35%
20	14	0.005	0.011	0.01	102.68%	0.27%
30	15	0.005	0.007	0.00	50.36%	0.12%
30	16	0.007	0.006	0.00	-22.25%	0.08%
30	17	0.005	0.010	0.01	109.85%	0.25%
30	18	0.005	0.011	0.01	113.06%	0.30%
30	19	0.004	0.009	0.00	101.30%	0.22%
30	20	0.006	0.007	0.00	14.87%	0.05%
31	15a	0.005	0.017	0.01	239.46%	0.59%
31	16a	0.007	0.010	0.00	43.76%	0.16%
31	17a	0.005	0.006	0.00	19.71%	0.05%
31	18a	0.005	0.007	0.00	29.45%	0.08%
31	19a	0.004	0.016	0.01	274.19%	0.59%
31	20a	0.006	0.007	0.00	14.87%	0.05%
50	21	0.005	0.007	0.00	51.62%	0.13%
50	22	0.004	0.007	0.00	63.89%	0.13%
50	23	0.006	0.007	0.00	17.09%	0.05%
50	24	0.005	0.007	0.00	61.98%	0.14%
50	25	0.005	0.009	0.00	72.59%	0.19%
	Max	0.010	0.048	0.04	456.65%	1.90%
	Average	0.005	0.011	0.01	108.46%	0.27%
	Min	0.002	0.006	0.00	-22.25%	0.00%
	Std Dev	0.002	0.008	0.01	114.13%	0.36%

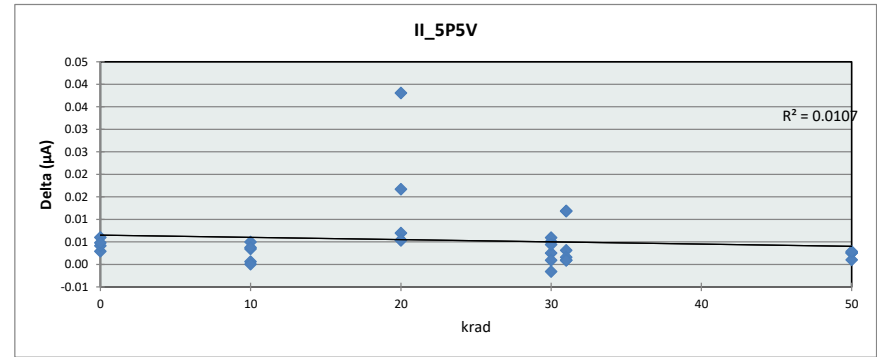

II_5P5V							
		Units					
		μA					
		Max Limit					
		1					
		Min Limit					
		-1					
krad		0	10	20	30	31	50
LL		-1.000	-1.000	-1.000	-1.000	-1.000	-1.000
Min		0.008	0.006	0.011	0.006	0.006	0.007
Average		0.009	0.008	0.020	0.008	0.010	0.007
Max		0.009	0.011	0.048	0.011	0.017	0.009
UL		1.000	1.000	1.000	1.000	1.000	1.000

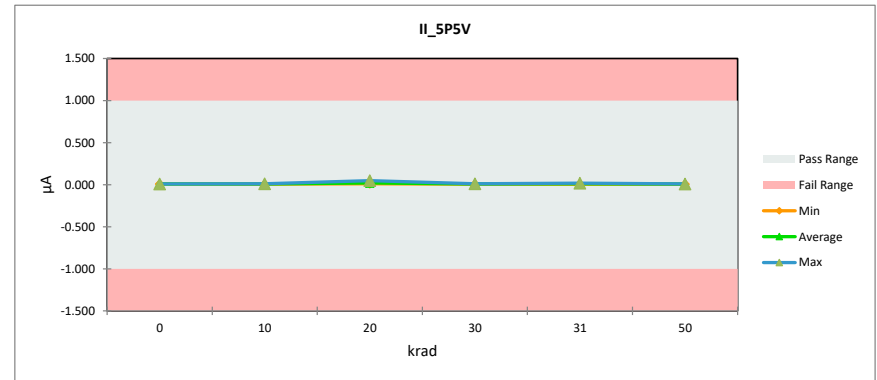

TID Report SN54SC8T138-SEP

		VIH_1P2V				
Units		V				
Max Limit		0.78				
Min Limit		0.18				
krad	Serial #	PreTestHDR	PostTestHDR	Delta	Delta %	% of Limit Range
0	1	0.544	0.545	0.00	0.11%	0.10%
0	2	0.543	0.542	0.00	-0.11%	0.10%
0	3	0.544	0.544	0.00	0.00%	0.00%
0	4	0.542	0.543	0.00	0.22%	0.20%
10	5	0.544	0.522	-0.02	-4.01%	3.64%
10	6	0.545	0.517	-0.03	-5.12%	4.65%
10	7	0.543	0.522	-0.02	-3.91%	3.54%
10	8	0.544	0.524	-0.02	-3.57%	3.23%
10	9	0.546	0.521	-0.02	-4.56%	4.14%
20	10	0.542	0.368	-0.17	-32.11%	29.01%
20	11	0.545	0.355	-0.19	-34.86%	31.64%
20	12	0.541	0.353	-0.19	-34.65%	31.23%
20	13	0.546	0.379	-0.17	-30.64%	27.90%
20	14	0.545	0.378	-0.17	-30.70%	27.90%
30	15	0.545	0.104	-0.44	-80.86%	73.38%
30	16	0.545	0.123	-0.42	-77.40%	70.24%
30	17	0.541	0.110	-0.43	-79.63%	71.86%
30	18	0.546	0.108	-0.44	-80.14%	72.97%
30	19	0.541	0.102	-0.44	-81.18%	73.18%
30	20	0.547	0.108	-0.44	-80.27%	73.18%
31	15a	0.545	0.378	-0.17	-30.52%	27.69%
31	16a	0.545	0.399	-0.15	-26.73%	24.26%
31	17a	0.541	0.415	-0.13	-23.41%	21.12%
31	18a	0.546	0.425	-0.12	-22.20%	20.21%
31	19a	0.541	0.381	-0.16	-29.60%	26.68%
31	20a	0.547	0.394	-0.15	-28.05%	25.57%
50	21	0.545	0.101	-0.44	-81.52%	73.98%
50	22	0.546	0.101	-0.45	-81.56%	74.19%
50	23	0.543	0.101	-0.44	-81.48%	73.78%
50	24	0.545	0.101	-0.44	-81.52%	73.98%
50	25	0.547	0.101	-0.45	-81.61%	74.39%
	Max	0.547	0.545	0.00	0.22%	74.19%
	Average	0.544	0.335	-0.21	-38.33%	34.79%
	Min	0.541	0.101	-0.44	-81.56%	0.00%
	Std Dev	0.002	0.177	0.17	32.48%	29.44%

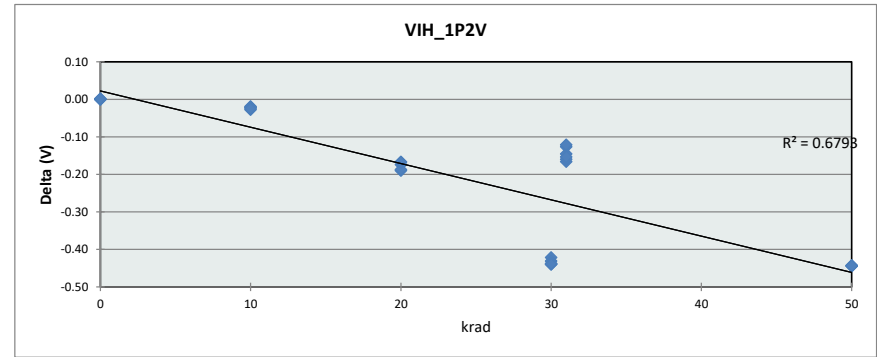

		VIH_1P2V					
Units		V					
Max Limit		0.78					
Min Limit		0.18					
krad		0	10	20	30	31	50
LL		0.180	0.180	0.180	0.180	0.180	0.180
Min		0.542	0.517	0.353	0.102	0.378	0.101
Average		0.543	0.521	0.367	0.109	0.399	0.101
Max		0.545	0.524	0.379	0.123	0.425	0.101
UL		0.780	0.780	0.780	0.780	0.780	0.780

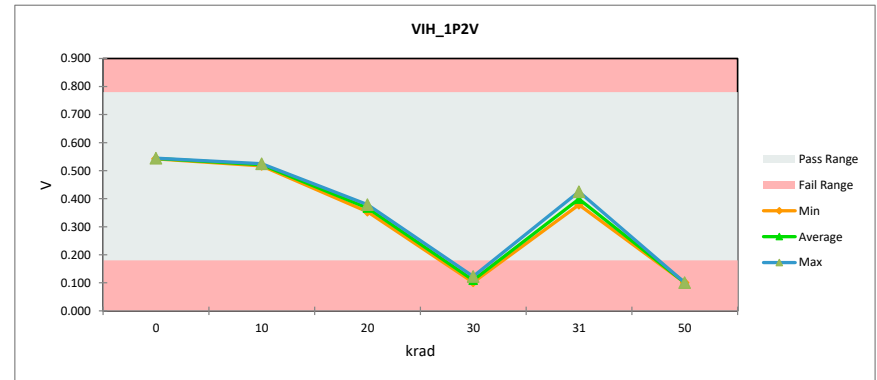

TID Report SN54SC8T138-SEP

		VIH_1P65V				
		Units		V		
		Max Limit		1.1		
		Min Limit		0.5		
krad	Serial #	PreTestHDR	PostTestHDR	Delta	Delta %	% of Limit Range
0	1	0.707	0.707	0.00	0.00%	0.00%
0	2	0.706	0.705	0.00	-0.12%	0.15%
0	3	0.706	0.706	0.00	0.00%	0.00%
0	4	0.706	0.705	0.00	-0.12%	0.15%
10	5	0.707	0.691	-0.02	-2.24%	2.64%
10	6	0.708	0.688	-0.02	-2.85%	3.37%
10	7	0.706	0.690	-0.02	-2.24%	2.64%
10	8	0.706	0.692	-0.01	-1.99%	2.34%
10	9	0.708	0.690	-0.02	-2.61%	3.08%
20	10	0.705	0.634	-0.07	-10.10%	11.87%
20	11	0.709	0.633	-0.08	-10.78%	12.75%
20	12	0.705	0.627	-0.08	-11.10%	13.04%
20	13	0.710	0.640	-0.07	-9.90%	11.72%
20	14	0.707	0.636	-0.07	-9.95%	11.72%
30	15	0.707	0.510	-0.20	-27.87%	32.83%
30	16	0.708	0.534	-0.17	-24.57%	29.02%
30	17	0.705	0.512	-0.19	-27.32%	32.10%
30	18	0.708	0.529	-0.18	-25.23%	29.75%
30	19	0.706	0.519	-0.19	-26.53%	31.22%
30	20	0.709	0.530	-0.18	-25.29%	29.90%
31	15a	0.707	0.631	-0.08	-10.70%	12.60%
31	16a	0.708	0.643	-0.07	-9.31%	10.99%
31	17a	0.705	0.636	-0.07	-9.73%	11.43%
31	18a	0.708	0.641	-0.07	-9.44%	11.14%
31	19a	0.706	0.637	-0.07	-9.72%	11.43%
31	20a	0.709	0.644	-0.07	-9.17%	10.84%
50	21	0.707	0.228	-0.48	-67.68%	79.73%
50	22	0.707	0.237	-0.47	-66.44%	78.26%
50	23	0.708	0.237	-0.47	-66.48%	78.41%
50	24	0.708	0.237	-0.47	-66.48%	78.41%
50	25	0.710	0.219	-0.49	-69.21%	81.92%
	Max	0.710	0.707	0.00	0.00%	79.73%
	Average	0.707	0.578	-0.13	-18.20%	21.45%
	Min	0.705	0.228	-0.48	-67.68%	0.00%
	Std Dev	0.001	0.150	0.15	21.28%	25.08%

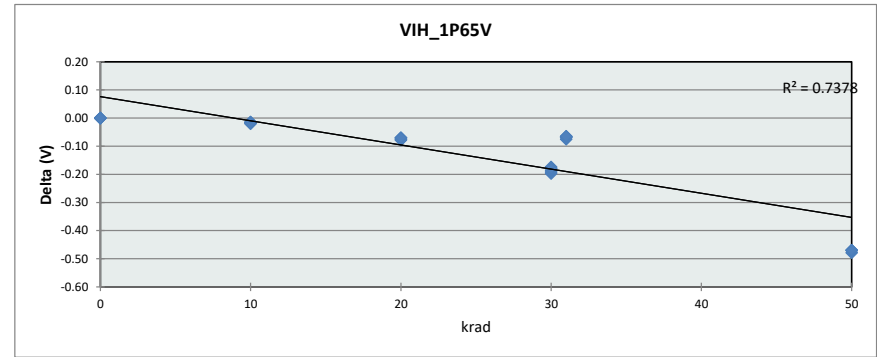

		VIH_1P65V					
		Units		V			
		Max Limit		1.1			
		Min Limit		0.5			
krad		0	10	20	30	31	50
LL		0.500	0.500	0.500	0.500	0.500	0.500
Min		0.705	0.688	0.627	0.510	0.631	0.219
Average		0.706	0.690	0.634	0.522	0.639	0.232
Max		0.707	0.692	0.640	0.534	0.644	0.237
UL		1.100	1.100	1.100	1.100	1.100	1.100

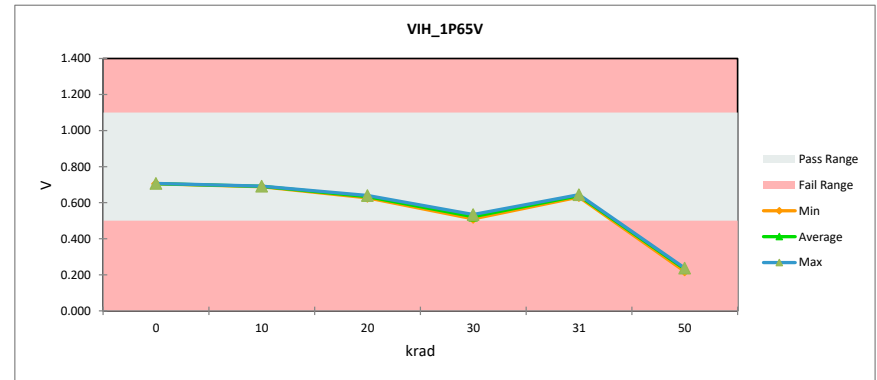

TID Report

SN54SC8T138-SEP

		VIH_2P25V				
Units		V				
Max Limit		1.28				
Min Limit		0.65				
krad	Serial #	PreTestHDR	PostTestHDR	Delta	Delta %	% of Limit Range
0	1	0.876	0.878	0.00	0.28%	0.39%
0	2	0.872	0.876	0.00	0.43%	0.59%
0	3	0.872	0.876	0.00	0.43%	0.59%
0	4	0.874	0.878	0.00	0.43%	0.59%
10	5	0.876	0.867	-0.01	-0.99%	1.38%
10	6	0.877	0.868	-0.01	-0.99%	1.38%
10	7	0.876	0.866	-0.01	-1.14%	1.58%
10	8	0.874	0.863	-0.01	-1.28%	1.78%
10	9	0.873	0.863	-0.01	-1.14%	1.58%
20	10	0.877	0.833	-0.04	-4.96%	6.91%
20	11	0.881	0.830	-0.05	-5.79%	8.09%
20	12	0.876	0.829	-0.05	-5.39%	7.50%
20	13	0.879	0.833	-0.05	-5.23%	7.30%
20	14	0.874	0.835	-0.04	-4.55%	6.31%
30	15	0.876	0.768	-0.11	-12.35%	17.17%
30	16	0.879	0.783	-0.10	-11.03%	15.39%
30	17	0.874	0.771	-0.10	-11.80%	16.38%
30	18	0.876	0.778	-0.10	-11.21%	15.59%
30	19	0.873	0.770	-0.10	-11.82%	16.38%
30	20	0.879	0.780	-0.10	-11.31%	15.79%
31	15a	0.876	0.831	-0.04	-5.11%	7.10%
31	16a	0.879	0.832	-0.05	-5.37%	7.50%
31	17a	0.874	0.830	-0.04	-5.12%	7.10%
31	18a	0.876	0.832	-0.04	-4.97%	6.91%
31	19a	0.873	0.829	-0.04	-5.13%	7.10%
31	20a	0.879	0.836	-0.04	-4.95%	6.91%
50	21	0.877	0.606	-0.27	-30.90%	43.02%
50	22	0.877	0.610	-0.27	-30.48%	42.43%
50	23	0.877	0.612	-0.26	-30.19%	42.03%
50	24	0.878	0.611	-0.27	-30.43%	42.43%
50	25	0.882	0.597	-0.28	-32.28%	45.19%
Max		0.881	0.878	0.00	0.43%	43.02%
Average		0.876	0.802	-0.07	-8.40%	11.84%
Min		0.872	0.606	-0.27	-30.90%	0.39%
Std Dev		0.002	0.084	0.08	9.67%	13.33%

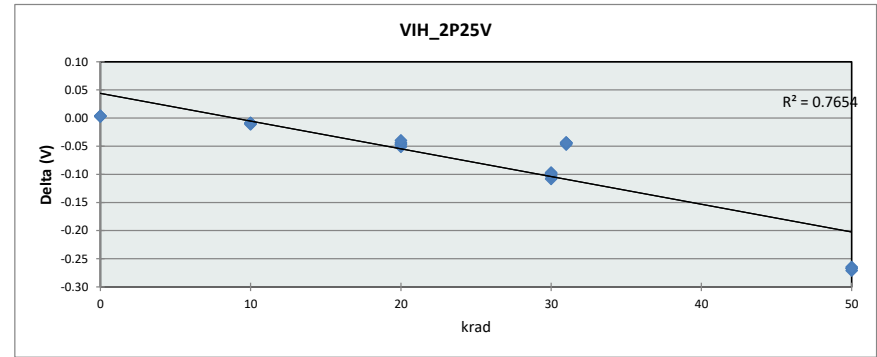

		VIH_2P25V				
Units		V				
Max Limit		1.28				
Min Limit		0.65				
krad	0	10	20	30	31	50
LL	0.650	0.650	0.650	0.650	0.650	0.650
Min	0.876	0.863	0.829	0.768	0.829	0.597
Average	0.877	0.866	0.832	0.775	0.832	0.607
Max	0.878	0.868	0.835	0.783	0.836	0.612
UL	1.280	1.280	1.280	1.280	1.280	1.280

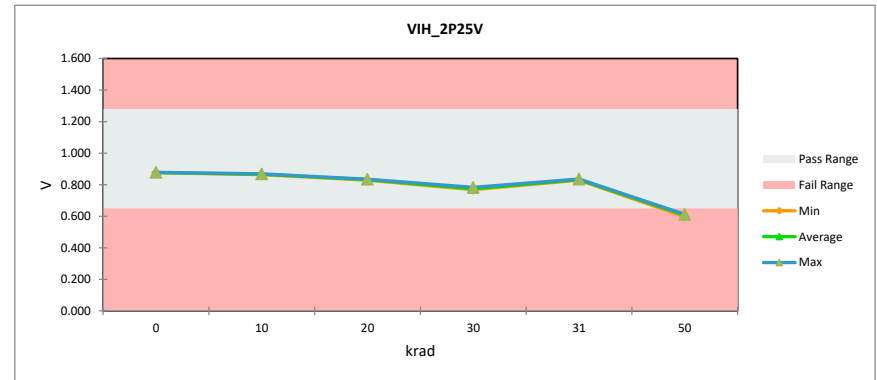

TID Report SN54SC8T138-SEP

		VIH_3V				
		Units		V		
		Max Limit		1.45		
		Min Limit		0.75		
krad	Serial #	PreTestHDR	PostTestHDR	Delta	Delta %	% of Limit Range
0	1	1.056	1.059	0.00	0.32%	0.49%
0	2	1.051	1.054	0.00	0.32%	0.49%
0	3	1.058	1.056	0.00	-0.16%	0.24%
0	4	1.054	1.054	0.00	0.00%	0.00%
10	5	1.056	1.046	-0.01	-0.96%	1.46%
10	6	1.056	1.046	-0.01	-0.96%	1.46%
10	7	1.059	1.044	-0.02	-1.44%	2.18%
10	8	1.056	1.047	-0.01	-0.80%	1.21%
10	9	1.059	1.047	-0.01	-1.12%	1.70%
20	10	1.053	1.020	-0.03	-3.07%	4.61%
20	11	1.059	1.022	-0.04	-3.53%	5.34%
20	12	1.054	1.012	-0.04	-4.03%	6.06%
20	13	1.058	1.024	-0.03	-3.21%	4.85%
20	14	1.058	1.020	-0.04	-3.53%	5.34%
30	15	1.058	0.980	-0.08	-7.38%	11.16%
30	16	1.059	0.990	-0.07	-6.57%	9.95%
30	17	1.056	0.983	-0.07	-6.91%	10.43%
30	18	1.058	0.985	-0.07	-6.90%	10.43%
30	19	1.059	0.980	-0.08	-7.53%	11.40%
30	20	1.059	0.986	-0.07	-6.89%	10.43%
31	15a	1.058	1.019	-0.04	-3.69%	5.58%
31	16a	1.059	1.024	-0.04	-3.37%	5.09%
31	17a	1.056	1.019	-0.04	-3.54%	5.34%
31	18a	1.058	1.022	-0.04	-3.37%	5.09%
31	19a	1.059	1.022	-0.04	-3.53%	5.34%
31	20a	1.059	1.022	-0.04	-3.53%	5.34%
50	21	1.056	0.893	-0.16	-15.44%	23.29%
50	22	1.056	0.898	-0.16	-14.95%	22.56%
50	23	1.059	0.898	-0.16	-15.23%	23.04%
50	24	1.058	0.896	-0.16	-15.25%	23.04%
50	25	1.061	0.891	-0.17	-16.00%	24.26%
	Max	1.059	1.059	0.00	0.32%	23.29%
	Average	1.057	1.006	-0.05	-4.88%	7.43%
	Min	1.051	0.893	-0.16	-15.44%	0.00%
	Std Dev	0.002	0.050	0.05	4.74%	7.09%

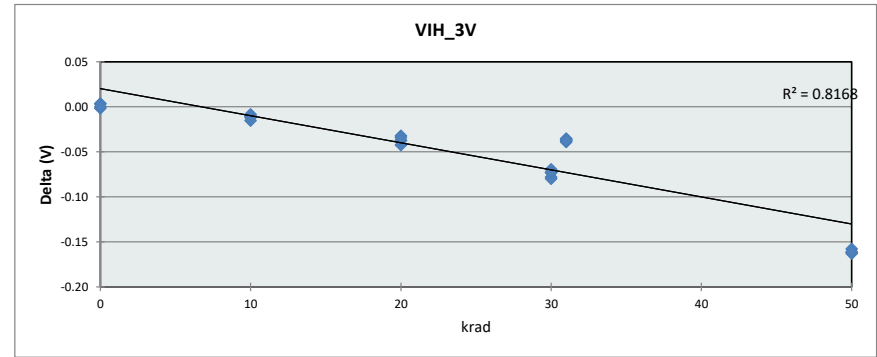

		VIH_3V				
		Units		V		
		Max Limit		1.45		
		Min Limit		0.75		
krad	0	10	20	30	31	50
LL	0.750	0.750	0.750	0.750	0.750	0.750
Min	1.054	1.044	1.012	0.980	1.019	0.891
Average	1.056	1.046	1.020	0.984	1.021	0.895
Max	1.059	1.047	1.024	0.990	1.024	0.898
UL	1.450	1.450	1.450	1.450	1.450	1.450

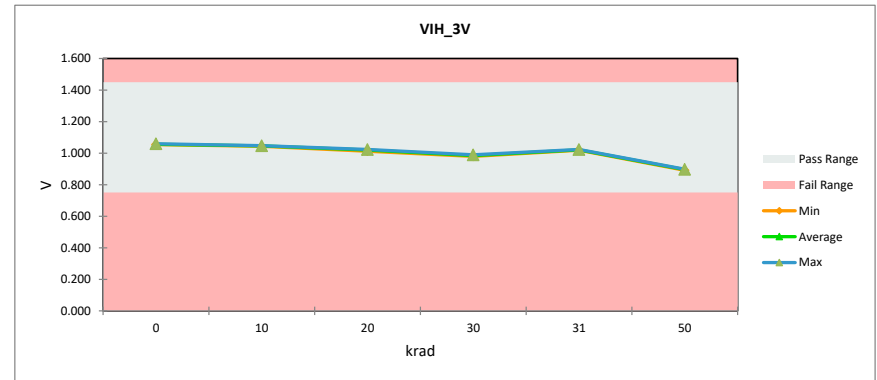

TID Report

SN54SC8T138-SEP

		VIH_4P5V					
		Units		V			
		Max Limit		2			
		Min Limit		0.85			
krad	Serial #	PreTestHDR	PostTestHDR	Delta	Delta %	% of Limit Range	
0	1	1.367	1.367	0.00	0.00%	0.00%	
0	2	1.359	1.359	0.00	0.00%	0.00%	
0	3	1.365	1.365	0.00	0.00%	0.00%	
0	4	1.359	1.359	0.00	0.00%	0.00%	
10	5	1.362	1.354	-0.01	-0.57%	0.68%	
10	6	1.365	1.354	-0.01	-0.76%	0.91%	
10	7	1.367	1.354	-0.01	-0.95%	1.13%	
10	8	1.365	1.354	-0.01	-0.76%	0.91%	
10	9	1.367	1.354	-0.01	-0.95%	1.13%	
20	10	1.359	1.331	-0.03	-2.11%	2.49%	
20	11	1.370	1.336	-0.03	-2.47%	2.95%	
20	12	1.362	1.328	-0.03	-2.49%	2.95%	
20	13	1.370	1.339	-0.03	-2.28%	2.72%	
20	14	1.365	1.333	-0.03	-2.29%	2.72%	
30	15	1.365	1.305	-0.06	-4.39%	5.22%	
30	16	1.370	1.310	-0.06	-4.38%	5.22%	
30	17	1.365	1.307	-0.06	-4.20%	4.99%	
30	18	1.365	1.307	-0.06	-4.20%	4.99%	
30	19	1.367	1.305	-0.06	-4.58%	5.44%	
30	20	1.367	1.310	-0.06	-4.20%	4.99%	
31	15a	1.365	1.331	-0.03	-2.48%	2.95%	
31	16a	1.370	1.339	-0.03	-2.28%	2.72%	
31	17a	1.365	1.336	-0.03	-2.10%	2.49%	
31	18a	1.365	1.333	-0.03	-2.29%	2.72%	
31	19a	1.367	1.336	-0.03	-2.29%	2.72%	
31	20a	1.367	1.339	-0.03	-2.10%	2.49%	
50	21	1.362	1.250	-0.11	-8.23%	9.75%	
50	22	1.365	1.258	-0.11	-7.83%	9.30%	
50	23	1.367	1.253	-0.11	-8.39%	9.98%	
50	24	1.365	1.255	-0.11	-8.03%	9.52%	
50	25	1.367	1.250	-0.12	-8.58%	10.20%	
Max		1.370	1.367	0.00	0.00%	9.98%	
Average		1.365	1.325	-0.04	-2.92%	3.47%	
Min		1.359	1.250	-0.11	-8.39%	0.00%	
Std Dev		0.003	0.034	0.03	2.50%	2.97%	

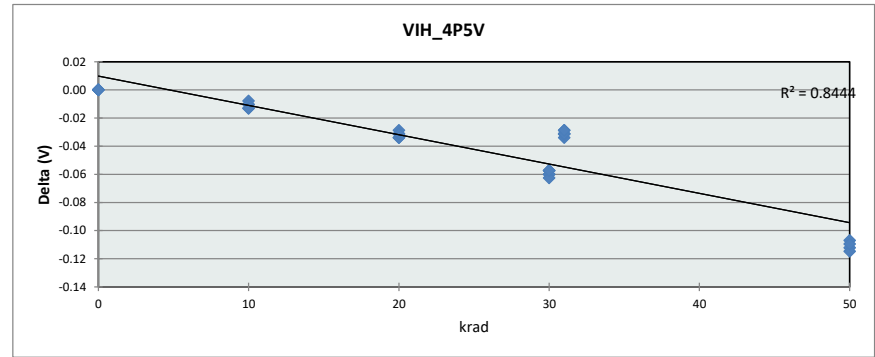

		VIH_4P5V					
		Units		V			
		Max Limit		2			
		Min Limit		0.85			
krad		0	10	20	30	31	50
LL		0.850	0.850	0.850	0.850	0.850	0.850
Min		1.359	1.354	1.328	1.305	1.331	1.250
Average		1.363	1.354	1.333	1.307	1.336	1.253
Max		1.367	1.354	1.339	1.310	1.339	1.258
UL		2.000	2.000	2.000	2.000	2.000	2.000

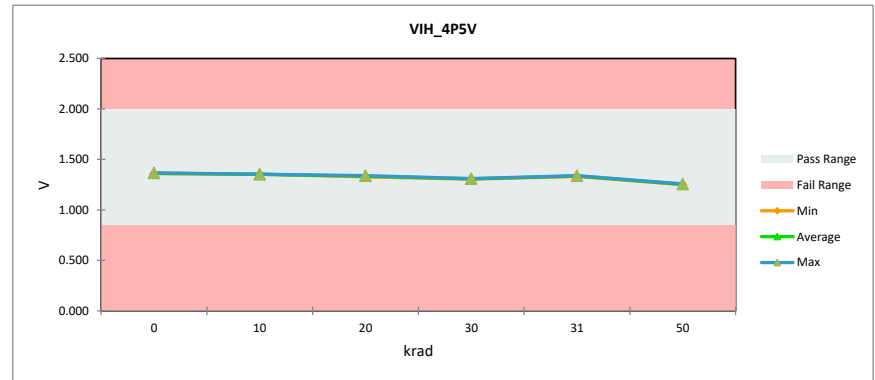

TID Report SN54SC8T138-SEP

		VIH_5P5V				
		Units		V		
		Max Limit		2		
		Min Limit		0.85		
krad	Serial #	PreTestHDR	PostTestHDR	Delta	Delta %	% of Limit Range
0	1	1.553	1.553	0.00	0.00%	0.00%
0	2	1.543	1.543	0.00	0.00%	0.00%
0	3	1.553	1.550	0.00	-0.21%	0.28%
0	4	1.546	1.550	0.00	0.21%	0.28%
10	5	1.550	1.540	-0.01	-0.62%	0.84%
10	6	1.550	1.537	-0.01	-0.83%	1.12%
10	7	1.553	1.540	-0.01	-0.83%	1.12%
10	8	1.550	1.540	-0.01	-0.62%	0.84%
10	9	1.553	1.540	-0.01	-0.83%	1.12%
20	10	1.546	1.514	-0.03	-2.08%	2.79%
20	11	1.556	1.521	-0.04	-2.27%	3.07%
20	12	1.550	1.517	-0.03	-2.07%	2.79%
20	13	1.556	1.524	-0.03	-2.07%	2.79%
20	14	1.553	1.517	-0.04	-2.28%	3.07%
30	15	1.550	1.492	-0.06	-3.73%	5.03%
30	16	1.553	1.498	-0.05	-3.52%	4.75%
30	17	1.550	1.495	-0.05	-3.53%	4.75%
30	18	1.550	1.495	-0.05	-3.53%	4.75%
30	19	1.553	1.495	-0.06	-3.73%	5.03%
30	20	1.553	1.501	-0.05	-3.31%	4.47%
31	15a	1.550	1.517	-0.03	-2.07%	2.79%
31	16a	1.553	1.524	-0.03	-1.86%	2.52%
31	17a	1.550	1.521	-0.03	-1.87%	2.52%
31	18a	1.550	1.521	-0.03	-1.87%	2.52%
31	19a	1.553	1.524	-0.03	-1.86%	2.52%
31	20a	1.553	1.524	-0.03	-1.86%	2.52%
50	21	1.550	1.443	-0.11	-6.84%	9.22%
50	22	1.550	1.450	-0.10	-6.43%	8.66%
50	23	1.553	1.447	-0.11	-6.83%	9.22%
50	24	1.553	1.450	-0.10	-6.62%	8.94%
50	25	1.553	1.447	-0.11	-6.83%	9.22%
	Max	1.556	1.553	0.00	0.21%	9.22%
	Average	1.551	1.513	-0.04	-2.47%	3.34%
	Min	1.543	1.443	-0.10	-6.84%	0.00%
	Std Dev	0.003	0.031	0.03	2.04%	2.72%

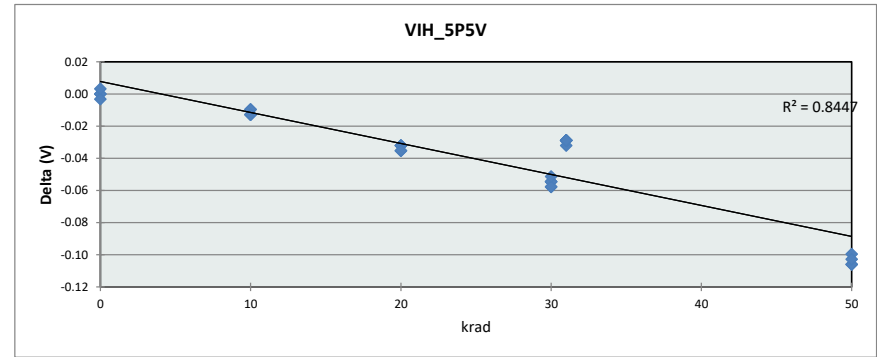

		VIH_5P5V					
		Units					
		Max Limit					
		Min Limit					
		0.85					
krad		0	10	20	30	31	50
LL		0.850	0.850	0.850	0.850	0.850	0.850
Min		1.543	1.537	1.514	1.492	1.517	1.443
Average		1.549	1.539	1.519	1.496	1.522	1.447
Max		1.553	1.540	1.524	1.501	1.524	1.450
UL		2.000	2.000	2.000	2.000	2.000	2.000

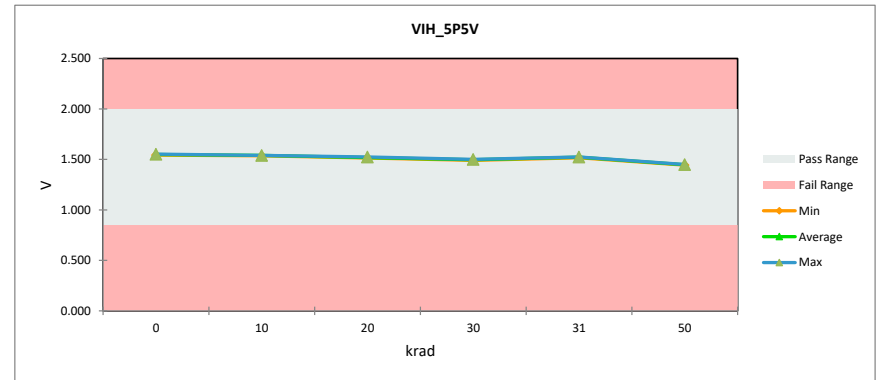

TID Report SN54SC8T138-SEP

		VIL_1P2V					
		Units		V			
		Max Limit		0.78			
		Min Limit		0.18			
krad	Serial #	PreTestHDR	PostTestHDR	Delta	Delta %	% of Limit Range	
0	1	0.523	0.517	-0.01	-1.15%	1.00%	
0	2	0.523	0.518	-0.01	-1.02%	0.89%	
0	3	0.524	0.518	-0.01	-1.15%	1.00%	
0	4	0.523	0.517	-0.01	-1.15%	1.00%	
10	5	0.526	0.502	-0.02	-4.69%	4.11%	
10	6	0.528	0.503	-0.02	-4.68%	4.11%	
10	7	0.522	0.493	-0.03	-5.50%	4.78%	
10	8	0.525	0.497	-0.03	-5.34%	4.67%	
10	9	0.524	0.498	-0.03	-5.09%	4.45%	
20	10	0.525	0.378	-0.15	-27.96%	24.46%	
20	11	0.526	0.336	-0.19	-36.13%	31.69%	
20	12	0.523	0.358	-0.17	-31.64%	27.57%	
20	13	0.528	0.375	-0.15	-29.04%	25.57%	
20	14	0.525	0.378	-0.15	-28.08%	24.57%	
30	15	0.527	0.131	-0.40	-75.20%	66.04%	
30	16	0.528	0.125	-0.40	-76.37%	67.16%	
30	17	0.523	0.155	-0.37	-70.42%	61.37%	
30	18	0.524	0.127	-0.40	-75.81%	66.16%	
30	19	0.522	0.121	-0.40	-76.86%	66.82%	
30	20	0.528	0.134	-0.39	-74.63%	65.71%	
31	15a	0.527	0.385	-0.14	-26.97%	23.68%	
31	16a	0.528	0.384	-0.14	-27.31%	24.02%	
31	17a	0.523	0.384	-0.14	-26.66%	23.24%	
31	18a	0.524	0.394	-0.13	-24.72%	21.57%	
31	19a	0.522	0.393	-0.13	-24.68%	21.46%	
31	20a	0.528	0.398	-0.13	-24.62%	21.68%	
50	21	0.524	0.102	-0.42	-80.52%	70.27%	
50	22	0.526	0.099	-0.43	-81.13%	71.16%	
50	23	0.524	0.102	-0.42	-80.54%	70.38%	
50	24	0.527	0.104	-0.42	-80.26%	70.49%	
50	25	0.530	0.099	-0.43	-81.27%	71.83%	
Max		0.528	0.518	-0.01	-1.02%	71.16%	
Average		0.525	0.331	-0.19	-36.98%	32.37%	
Min		0.522	0.099	-0.42	-81.13%	0.89%	
Std Dev		0.002	0.161	0.16	30.80%	26.96%	

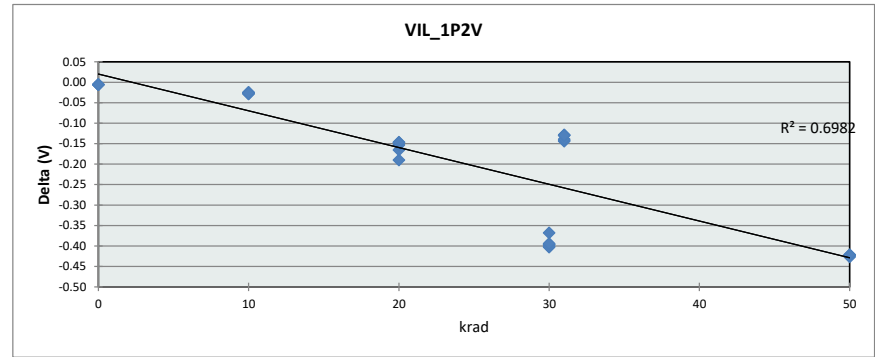

		VIL_1P2V					
		Units		V			
		Max Limit		0.78			
		Min Limit		0.18			
krad		0	10	20	30	31	50
LL		0.180	0.180	0.180	0.180	0.180	0.180
Min		0.517	0.493	0.336	0.121	0.384	0.099
Average		0.517	0.498	0.365	0.132	0.390	0.101
Max		0.518	0.503	0.378	0.155	0.398	0.104
UL		0.780	0.780	0.780	0.780	0.780	0.780

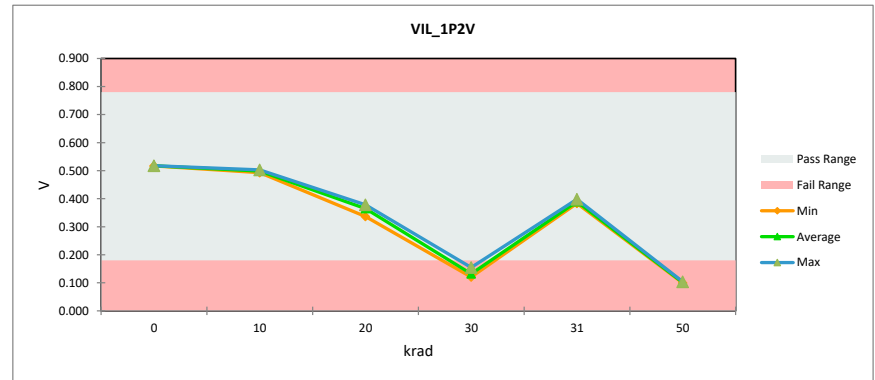

TID Report SN54SC8T138-SEP

		VIL_1P65V				
Units		V				
Max Limit		1.1				
Min Limit		0.5				
krad	Serial #	PreTestHDR	PostTestHDR	Delta	Delta %	% of Limit Range
0	1	0.686	0.687	0.00	0.14%	0.16%
0	2	0.687	0.684	0.00	-0.42%	0.48%
0	3	0.686	0.685	0.00	-0.14%	0.16%
0	4	0.686	0.686	0.00	0.00%	0.00%
10	5	0.689	0.672	-0.02	-2.53%	2.90%
10	6	0.690	0.673	-0.02	-2.52%	2.90%
10	7	0.687	0.669	-0.02	-2.67%	3.06%
10	8	0.689	0.670	-0.02	-2.81%	3.22%
10	9	0.689	0.670	-0.02	-2.81%	3.22%
20	10	0.689	0.618	-0.07	-10.39%	11.93%
20	11	0.691	0.613	-0.08	-11.34%	13.06%
20	12	0.689	0.609	-0.08	-11.65%	13.38%
20	13	0.692	0.622	-0.07	-10.06%	11.61%
20	14	0.690	0.618	-0.07	-10.37%	11.93%
30	15	0.688	0.505	-0.18	-26.57%	30.47%
30	16	0.692	0.517	-0.18	-25.30%	29.18%
30	17	0.687	0.507	-0.18	-26.18%	29.99%
30	18	0.687	0.525	-0.16	-23.65%	27.08%
30	19	0.685	0.514	-0.17	-24.99%	28.54%
30	20	0.693	0.526	-0.17	-24.15%	27.89%
31	15a	0.688	0.614	-0.07	-10.82%	12.41%
31	16a	0.692	0.621	-0.07	-10.20%	11.77%
31	17a	0.687	0.618	-0.07	-9.99%	11.45%
31	18a	0.687	0.623	-0.06	-9.29%	10.64%
31	19a	0.685	0.620	-0.06	-9.46%	10.80%
31	20a	0.693	0.627	-0.07	-9.49%	10.96%
50	21	0.688	0.224	-0.46	-67.47%	77.38%
50	22	0.691	0.231	-0.46	-66.63%	76.74%
50	23	0.688	0.230	-0.46	-66.63%	76.42%
50	24	0.691	0.230	-0.46	-66.77%	76.90%
50	25	0.695	0.212	-0.48	-69.46%	80.45%
Max		0.693	0.687	-0.01	0.14%	77.38%
Average		0.689	0.564	-0.13	-18.17%	20.89%
Min		0.685	0.224	-0.46	-67.47%	0.00%
Std Dev		0.002	0.146	0.14	21.16%	24.31%

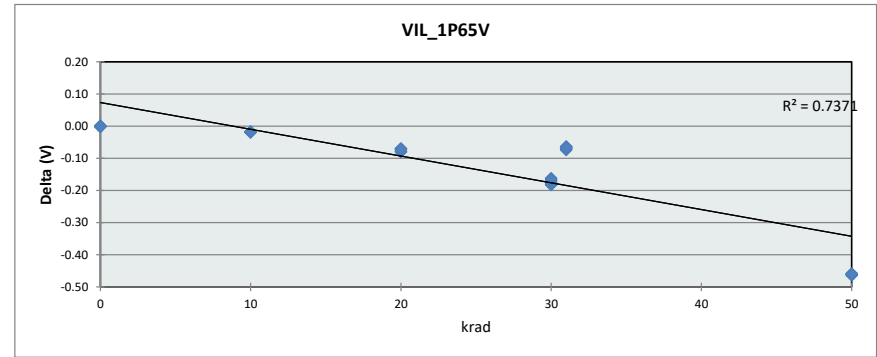

		VIL_1P65V				
Units		V				
Max Limit		1.1				
Min Limit		0.5				
krad	0	10	20	30	31	50
LL	0.500	0.500	0.500	0.500	0.500	0.500
Min	0.684	0.669	0.609	0.505	0.614	0.212
Average	0.686	0.671	0.616	0.516	0.621	0.225
Max	0.687	0.673	0.622	0.526	0.627	0.231
UL	1.100	1.100	1.100	1.100	1.100	1.100

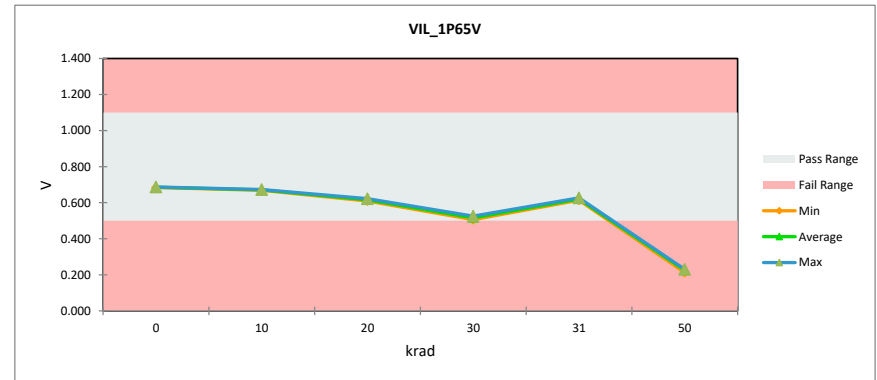

TID Report

SN54SC8T138-SEP

		VIL_2P25V				
Units		V				
Max Limit		1.28				
Min Limit		0.65				
krad	Serial #	PreTestHDR	PostTestHDR	Delta	Delta %	% of Limit Range
0	1	0.852	0.848	0.00	-0.48%	0.65%
0	2	0.849	0.844	-0.01	-0.64%	0.87%
0	3	0.849	0.844	-0.01	-0.64%	0.87%
0	4	0.849	0.844	-0.01	-0.64%	0.87%
10	5	0.849	0.833	-0.02	-1.93%	2.60%
10	6	0.851	0.832	-0.02	-2.25%	3.04%
10	7	0.851	0.833	-0.02	-2.09%	2.82%
10	8	0.849	0.833	-0.02	-1.93%	2.60%
10	9	0.851	0.833	-0.02	-2.09%	2.82%
20	10	0.848	0.799	-0.05	-5.81%	7.81%
20	11	0.854	0.800	-0.05	-6.25%	8.47%
20	12	0.849	0.793	-0.06	-6.60%	8.90%
20	13	0.852	0.804	-0.05	-5.62%	7.60%
20	14	0.849	0.799	-0.05	-5.96%	8.03%
30	15	0.851	0.754	-0.10	-11.41%	15.41%
30	16	0.854	0.751	-0.10	-12.02%	16.28%
30	17	0.851	0.755	-0.10	-11.25%	15.20%
30	18	0.851	0.758	-0.09	-10.93%	14.76%
30	19	0.849	0.758	-0.09	-10.79%	14.54%
30	20	0.854	0.769	-0.08	-9.93%	13.46%
31	15a	0.851	0.797	-0.05	-6.27%	8.47%
31	16a	0.854	0.807	-0.05	-5.45%	7.38%
31	17a	0.851	0.803	-0.05	-5.63%	7.60%
31	18a	0.851	0.804	-0.05	-5.47%	7.38%
31	19a	0.849	0.803	-0.05	-5.47%	7.38%
31	20a	0.854	0.808	-0.05	-5.29%	7.16%
50	21	0.849	0.598	-0.25	-29.62%	39.94%
50	22	0.851	0.602	-0.25	-29.25%	39.51%
50	23	0.852	0.603	-0.25	-29.21%	39.51%
50	24	0.851	0.603	-0.25	-29.09%	39.29%
50	25	0.854	0.588	-0.27	-31.08%	42.11%
Max		0.854	0.848	-0.01	-0.48%	39.94%
Average		0.851	0.777	-0.07	-8.67%	11.71%
Min		0.848	0.598	-0.25	-29.62%	0.65%
Std Dev		0.002	0.076	0.07	8.92%	12.05%

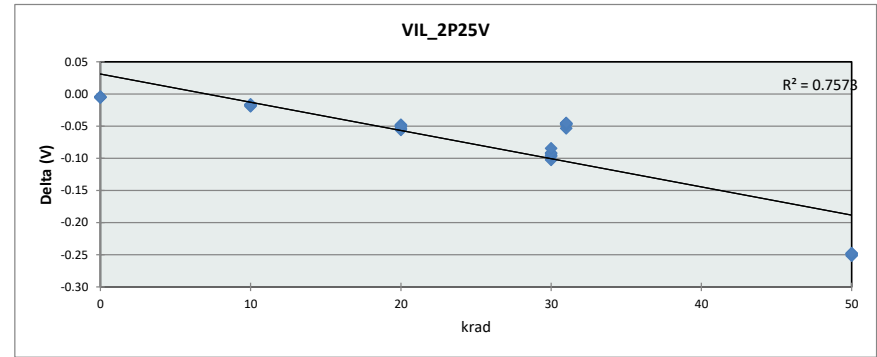

		VIL_2P25V				
Units		V				
Max Limit		1.28				
Min Limit		0.65				
krad	0	10	20	30	31	50
LL	0.650	0.650	0.650	0.650	0.650	0.650
Min	0.844	0.832	0.793	0.751	0.797	0.588
Average	0.845	0.833	0.799	0.757	0.804	0.599
Max	0.848	0.833	0.804	0.769	0.808	0.603
UL	1.280	1.280	1.280	1.280	1.280	1.280

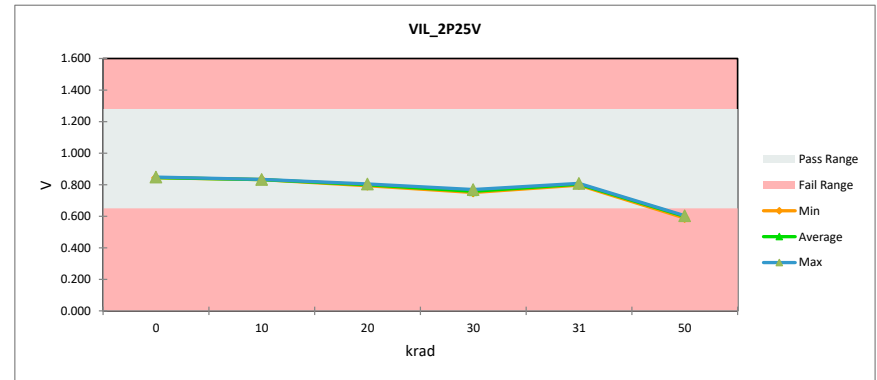

TID Report SN54SC8T138-SEP

		VIL_3V					
		V					
		1.45					
		0.75					
krad	Serial #	PreTestHDR	PostTestHDR	Delta	Delta %	% of Limit Range	
0	1	1.002	1.040	0.04	3.73%	5.34%	
0	2	1.036	1.030	-0.01	-0.54%	0.80%	
0	3	1.028	1.032	0.00	0.36%	0.53%	
0	4	1.004	1.034	0.03	2.98%	4.27%	
10	5	1.036	1.019	-0.02	-1.62%	2.40%	
10	6	0.997	1.028	0.03	3.19%	4.54%	
10	7	1.038	1.026	-0.01	-1.08%	1.60%	
10	8	1.040	1.025	-0.01	-1.44%	2.13%	
10	9	0.985	1.019	0.03	3.41%	4.80%	
20	10	1.017	1.002	-0.01	-1.47%	2.13%	
20	11	1.045	1.008	-0.04	-3.57%	5.34%	
20	12	1.041	1.000	-0.04	-3.95%	5.87%	
20	13	1.043	1.002	-0.04	-3.94%	5.87%	
20	14	1.030	1.000	-0.03	-2.90%	4.27%	
30	15	0.997	0.969	-0.03	-2.81%	4.00%	
30	16	1.015	0.967	-0.05	-4.78%	6.94%	
30	17	1.043	0.965	-0.08	-7.52%	11.21%	
30	18	0.998	0.974	-0.02	-2.43%	3.47%	
30	19	1.026	0.970	-0.06	-5.46%	8.01%	
30	20	1.045	0.970	-0.07	-7.15%	10.67%	
31	15a	0.997	0.998	0.00	0.19%	0.27%	
31	16a	1.015	1.006	-0.01	-0.92%	1.33%	
31	17a	1.043	1.002	-0.04	-3.94%	5.87%	
31	18a	0.998	1.002	0.00	0.37%	0.53%	
31	19a	1.026	1.000	-0.03	-2.55%	3.74%	
31	20a	1.045	1.008	-0.04	-3.57%	5.34%	
50	21	0.997	0.864	-0.13	-13.31%	18.95%	
50	22	1.025	0.870	-0.16	-15.13%	22.15%	
50	23	1.010	0.877	-0.13	-13.14%	18.95%	
50	24	1.000	0.877	-0.12	-12.32%	17.61%	
50	25	1.006	0.881	-0.13	-12.44%	17.88%	
	Max	1.045	1.040	-0.01	-3.73%	22.15%	
	Average	1.021	0.986	-0.03	-3.38%	6.30%	
	Min	0.985	0.864	-0.12	-15.13%	0.27%	
	Std Dev	0.019	0.050	0.03	4.93%	5.91%	

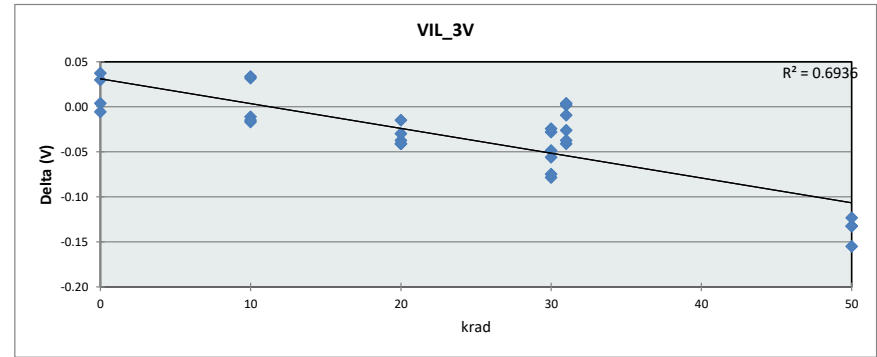

		VIL_3V					
		V					
		1.45					
		0.75					
krad		0	10	20	30	31	50
LL		0.750	0.750	0.750	0.750	0.750	0.750
Min		1.030	1.019	1.000	0.965	0.998	0.864
Average		1.034	1.023	1.003	0.969	1.003	0.874
Max		1.040	1.028	1.008	0.974	1.008	0.881
UL		1.450	1.450	1.450	1.450	1.450	1.450

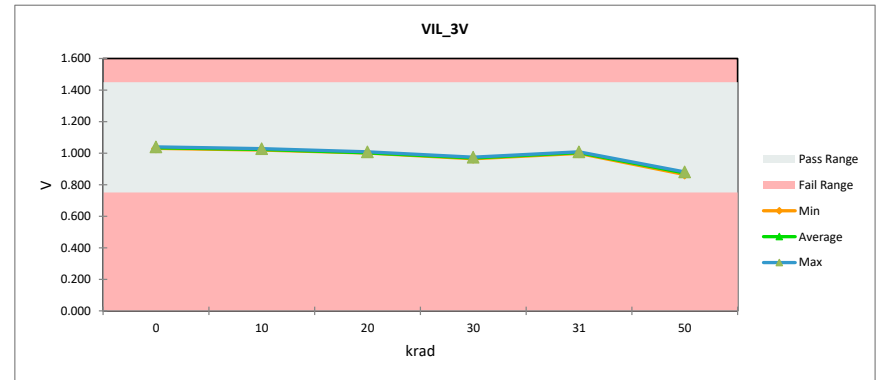

TID Report SN54SC8T138-SEP

		VIL_4P5V				
Units		V				
Max Limit		2				
Min Limit		0.85				
krad	Serial #	PreTestHDR	PostTestHDR	Delta	Delta %	% of Limit Range
0	1	1.354	1.328	-0.03	-1.91%	2.24%
0	2	1.348	1.319	-0.03	-2.13%	2.49%
0	3	1.354	1.322	-0.03	-2.33%	2.74%
0	4	1.351	1.328	-0.02	-1.70%	2.00%
10	5	1.351	1.316	-0.03	-2.55%	2.99%
10	6	1.354	1.319	-0.03	-2.54%	2.99%
10	7	1.354	1.319	-0.03	-2.54%	2.99%
10	8	1.354	1.313	-0.04	-2.97%	3.49%
10	9	1.354	1.313	-0.04	-2.97%	3.49%
20	10	1.348	1.299	-0.05	-3.62%	4.24%
20	11	1.356	1.305	-0.05	-3.81%	4.49%
20	12	1.351	1.293	-0.06	-4.25%	4.99%
20	13	1.356	1.302	-0.05	-4.02%	4.74%
20	14	1.354	1.296	-0.06	-4.24%	4.99%
30	15	1.354	1.273	-0.08	-5.93%	6.98%
30	16	1.356	1.273	-0.08	-6.13%	7.23%
30	17	1.354	1.276	-0.08	-5.72%	6.73%
30	18	1.351	1.296	-0.05	-4.04%	4.74%
30	19	1.356	1.273	-0.08	-6.13%	7.23%
30	20	1.356	1.282	-0.07	-5.50%	6.49%
31	15a	1.354	1.302	-0.05	-3.81%	4.49%
31	16a	1.356	1.302	-0.05	-4.02%	4.74%
31	17a	1.354	1.299	-0.05	-4.03%	4.74%
31	18a	1.351	1.302	-0.05	-3.61%	4.24%
31	19a	1.356	1.296	-0.06	-4.44%	5.24%
31	20a	1.356	1.305	-0.05	-3.81%	4.49%
50	21	1.351	1.222	-0.13	-9.56%	11.22%
50	22	1.351	1.222	-0.13	-9.56%	11.22%
50	23	1.356	1.227	-0.13	-9.52%	11.22%
50	24	1.354	1.227	-0.13	-9.32%	10.98%
50	25	1.356	1.230	-0.13	-9.31%	10.98%
Max		1.356	1.328	-0.03	-1.70%	11.22%
Average		1.353	1.292	-0.06	-4.56%	5.36%
Min		1.348	1.222	-0.13	-9.56%	2.00%
Std Dev		0.003	0.031	0.03	2.31%	2.72%

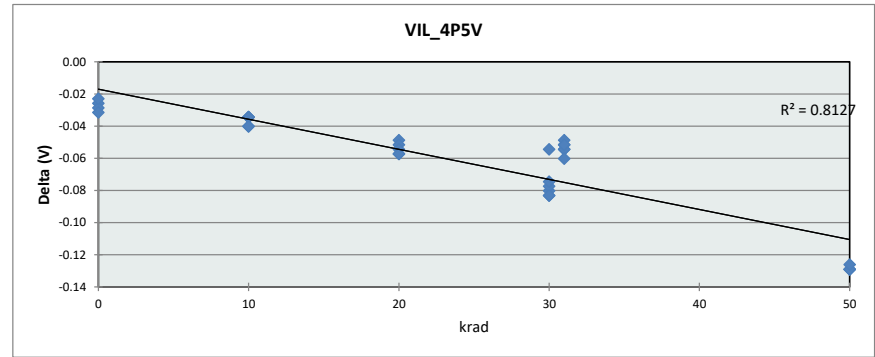

		VIL_4P5V				
Units		V				
Max Limit		2				
Min Limit		0.85				
krad	0	10	20	30	31	50
LL	0.850	0.850	0.850	0.850	0.850	0.850
Min	1.319	1.313	1.293	1.273	1.296	1.222
Average	1.324	1.316	1.299	1.279	1.301	1.226
Max	1.328	1.319	1.305	1.296	1.305	1.230
UL	2.000	2.000	2.000	2.000	2.000	2.000

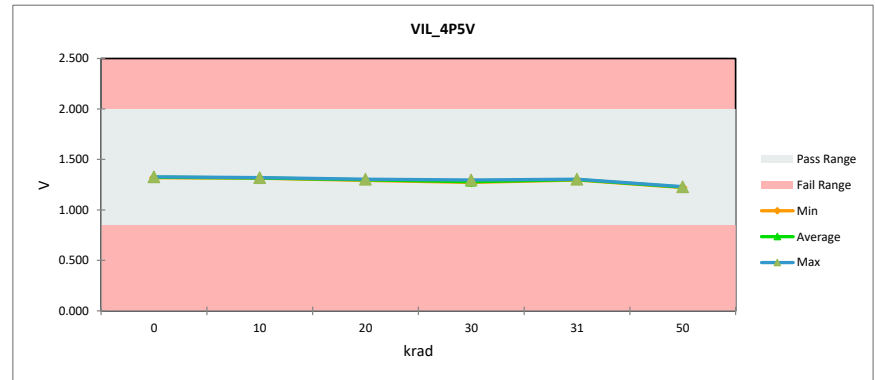

TID Report

SN54SC8T138-SEP

		VIL_5P5V					
		Units		V			
		Max Limit		2			
		Min Limit		0.85			
krad	Serial #	PreTestHDR	PostTestHDR	Delta	Delta %	% of Limit Range	
0	1	1.539	1.539	0.00	0.00%	0.00%	
0	2	1.528	1.528	0.00	0.00%	0.00%	
0	3	1.535	1.535	0.00	0.00%	0.00%	
0	4	1.528	1.528	0.00	0.00%	0.00%	
10	5	1.532	1.525	-0.01	-0.46%	0.61%	
10	6	1.535	1.525	-0.01	-0.69%	0.92%	
10	7	1.539	1.525	-0.01	-0.92%	1.23%	
10	8	1.535	1.525	-0.01	-0.69%	0.92%	
10	9	1.535	1.525	-0.01	-0.69%	0.92%	
20	10	1.532	1.500	-0.03	-2.08%	2.77%	
20	11	1.539	1.507	-0.03	-2.07%	2.77%	
20	12	1.532	1.497	-0.04	-2.31%	3.07%	
20	13	1.543	1.511	-0.03	-2.06%	2.77%	
20	14	1.535	1.504	-0.03	-2.07%	2.77%	
30	15	1.535	1.479	-0.06	-3.68%	4.92%	
30	16	1.539	1.482	-0.06	-3.68%	4.92%	
30	17	1.535	1.479	-0.06	-3.68%	4.92%	
30	18	1.535	1.479	-0.06	-3.68%	4.92%	
30	19	1.539	1.482	-0.06	-3.68%	4.92%	
30	20	1.539	1.486	-0.05	-3.45%	4.61%	
31	15a	1.535	1.482	-0.05	-3.45%	4.61%	
31	16a	1.539	1.482	-0.06	-3.68%	4.92%	
31	17a	1.535	1.479	-0.06	-3.68%	4.92%	
31	18a	1.535	1.482	-0.05	-3.45%	4.61%	
31	19a	1.539	1.479	-0.06	-3.91%	5.23%	
31	20a	1.539	1.486	-0.05	-3.45%	4.61%	
50	21	1.532	1.429	-0.10	-6.69%	8.92%	
50	22	1.535	1.436	-0.10	-6.45%	8.61%	
50	23	1.539	1.429	-0.11	-7.12%	9.53%	
50	24	1.535	1.433	-0.10	-6.68%	8.92%	
50	25	1.539	1.429	-0.11	-7.12%	9.53%	
Max		1.543	1.539	0.00	0.00%	9.53%	
Average		1.536	1.493	-0.04	-2.82%	3.76%	
Min		1.528	1.429	-0.10	-7.12%	0.00%	
Std Dev		0.003	0.031	0.03	2.09%	2.79%	

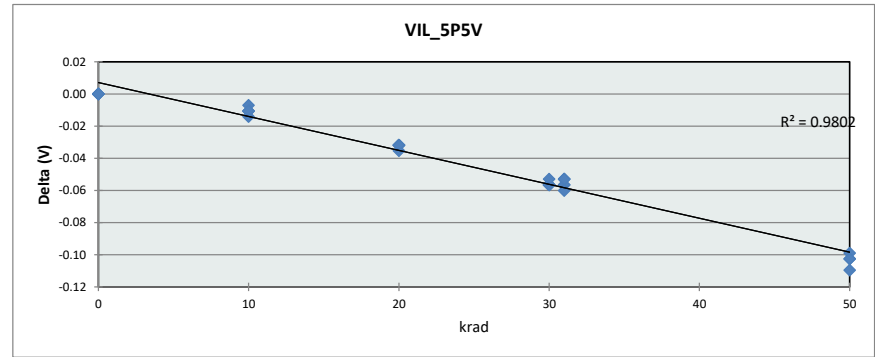

		VIL_5P5V					
		Units					
		Max Limit					
		Min Limit					
		0.85					
krad		0	10	20	30	31	50
LL		0.850	0.850	0.850	0.850	0.850	0.850
Min		1.528	1.525	1.497	1.479	1.479	1.429
Average		1.533	1.525	1.504	1.481	1.482	1.432
Max		1.539	1.525	1.511	1.486	1.486	1.436
UL		2.000	2.000	2.000	2.000	2.000	2.000

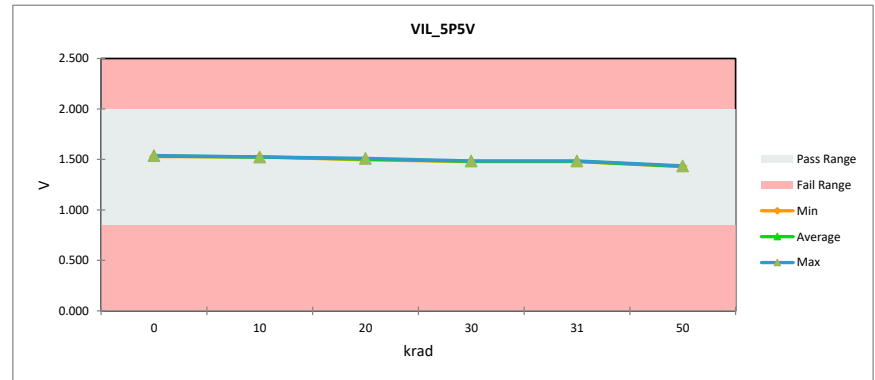

TID Report

SN54SC8T138-SEP

		VOH_N1MA_1P2V				
Units		V				
Max Limit		1.3				
Min Limit		0.8				
krad	Serial #	PreTestHDR	PostTestHDR	Delta	Delta %	% of Limit Range
0	1	1.137	1.137	0.00	-0.02%	0.03%
0	2	1.138	1.137	0.00	-0.03%	0.07%
0	3	1.137	1.137	0.00	0.00%	0.01%
0	4	1.138	1.137	0.00	-0.02%	0.05%
10	5	1.138	1.137	0.00	-0.03%	0.08%
10	6	1.138	1.137	0.00	-0.03%	0.08%
10	7	1.137	1.137	0.00	-0.02%	0.04%
10	8	1.138	1.137	0.00	-0.04%	0.08%
10	9	1.137	1.137	0.00	-0.03%	0.07%
20	10	1.137	1.137	0.00	-0.04%	0.09%
20	11	1.138	1.137	0.00	-0.05%	0.11%
20	12	1.138	1.137	0.00	-0.06%	0.13%
20	13	1.138	1.137	0.00	-0.05%	0.11%
20	14	1.138	1.137	0.00	-0.07%	0.17%
30	15	1.138	1.132	-0.01	-0.50%	1.14%
30	16	1.138	1.132	-0.01	-0.48%	1.09%
30	17	1.138	1.132	-0.01	-0.54%	1.23%
30	18	1.138	1.132	-0.01	-0.54%	1.23%
30	19	1.138	1.131	-0.01	-0.62%	1.42%
30	20	1.137	1.131	-0.01	-0.53%	1.21%
31	15a	1.138	1.137	0.00	-0.09%	0.20%
31	16a	1.138	1.137	0.00	-0.06%	0.13%
31	17a	1.138	1.137	0.00	-0.09%	0.20%
31	18a	1.138	1.137	0.00	-0.07%	0.17%
31	19a	1.138	1.137	0.00	-0.08%	0.18%
31	20a	1.137	1.137	0.00	-0.06%	0.13%
50	21	1.138	-0.042	-1.18	-103.68%	235.92%
50	22	1.138	-0.042	-1.18	-103.69%	235.94%
50	23	1.138	-0.042	-1.18	-103.69%	235.94%
50	24	1.138	-0.042	-1.18	-103.70%	235.96%
50	25	1.138	-0.042	-1.18	-103.70%	235.95%
	Max	1.138	1.137	0.00	0.00%	235.96%
	Average	1.138	0.979	-0.16	-13.96%	31.77%
	Min	1.137	-0.042	-1.18	-103.70%	0.01%
	Std Dev	0.000	0.407	0.41	35.80%	81.45%

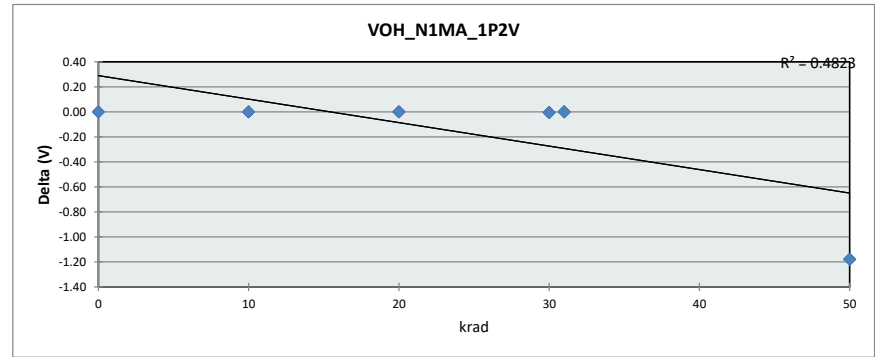

		VOH_N1MA_1P2V				
Units		V				
Max Limit		1.3				
Min Limit		0.8				
krad	0	10	20	30	31	50
LL	0.800	0.800	0.800	0.800	0.800	0.800
Min	1.137	1.137	1.137	1.131	1.137	-0.042
Average	1.137	1.137	1.137	1.132	1.137	-0.042
Max	1.137	1.137	1.137	1.132	1.137	-0.042
UL	1.300	1.300	1.300	1.300	1.300	1.300

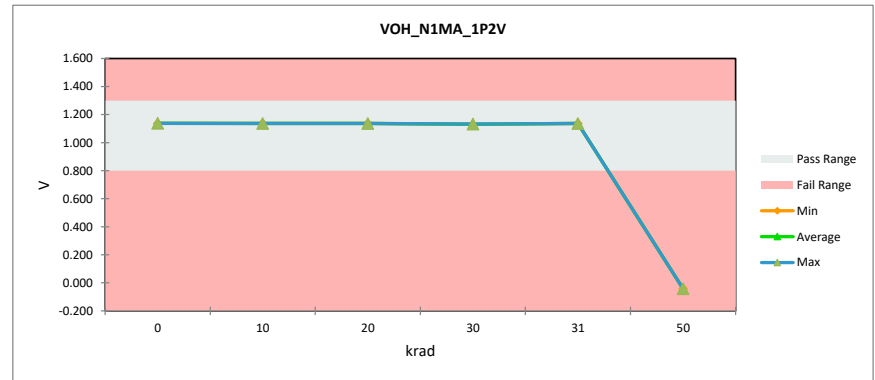

TID Report SN54SC8T138-SEP

		VOH_N2MA_1P65V				
Units		V				
Max Limit		1.75				
Min Limit		1.21				
krad	Serial #	PreTestHDR	PostTestHDR	Delta	Delta %	% of Limit Range
0	1	1.568	1.568	0.00	0.00%	0.01%
0	2	1.569	1.569	0.00	-0.01%	0.03%
0	3	1.568	1.568	0.00	-0.01%	0.03%
0	4	1.569	1.568	0.00	-0.01%	0.04%
10	5	1.569	1.568	0.00	-0.03%	0.08%
10	6	1.569	1.568	0.00	-0.02%	0.06%
10	7	1.569	1.568	0.00	-0.02%	0.06%
10	8	1.569	1.568	0.00	-0.03%	0.08%
10	9	1.569	1.568	0.00	-0.04%	0.12%
20	10	1.568	1.568	0.00	-0.02%	0.06%
20	11	1.569	1.568	0.00	-0.04%	0.10%
20	12	1.569	1.568	0.00	-0.04%	0.12%
20	13	1.569	1.568	0.00	-0.04%	0.12%
20	14	1.569	1.568	0.00	-0.04%	0.12%
30	15	1.569	1.567	0.00	-0.12%	0.34%
30	16	1.569	1.567	0.00	-0.12%	0.34%
30	17	1.569	1.566	0.00	-0.16%	0.45%
30	18	1.569	1.566	0.00	-0.14%	0.42%
30	19	1.569	1.566	0.00	-0.19%	0.54%
30	20	1.569	1.566	0.00	-0.17%	0.48%
31	15a	1.569	1.568	0.00	-0.05%	0.13%
31	16a	1.569	1.568	0.00	-0.04%	0.10%
31	17a	1.569	1.568	0.00	-0.04%	0.10%
31	18a	1.569	1.568	0.00	-0.04%	0.12%
31	19a	1.569	1.568	0.00	-0.04%	0.12%
31	20a	1.569	1.568	0.00	-0.05%	0.15%
50	21	1.569	1.544	-0.02	-1.55%	4.50%
50	22	1.569	1.544	-0.02	-1.59%	4.61%
50	23	1.569	1.543	-0.03	-1.64%	4.77%
50	24	1.569	1.544	-0.02	-1.58%	4.58%
50	25	1.569	1.544	-0.02	-1.57%	4.55%
	Max	1.569	1.569	0.00	0.00%	4.77%
	Average	1.569	1.565	0.00	-0.26%	0.76%
	Min	1.568	1.543	-0.03	-1.64%	0.01%
	Std Dev	0.000	0.008	0.01	0.53%	1.54%

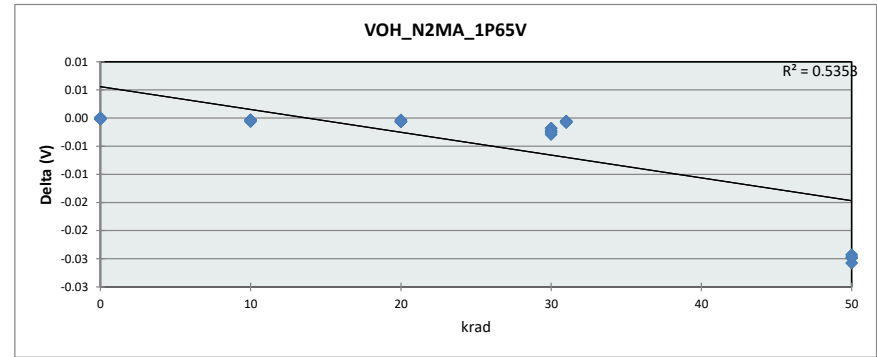

		VOH_N2MA_1P65V				
Units		V				
Max Limit		1.75				
Min Limit		1.21				
krad	0	10	20	30	31	50
LL	1.210	1.210	1.210	1.210	1.210	1.210
Min	1.568	1.568	1.568	1.566	1.568	1.543
Average	1.568	1.568	1.568	1.566	1.568	1.544
Max	1.569	1.568	1.568	1.567	1.568	1.544
UL	1.750	1.750	1.750	1.750	1.750	1.750

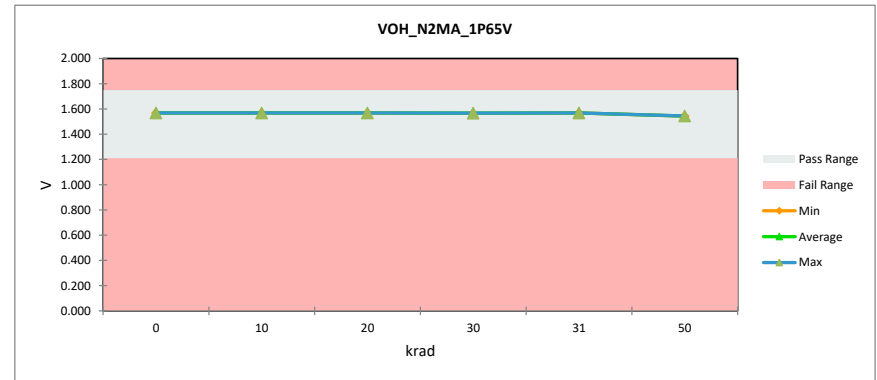

TID Report SN54SC8T138-SEP

		VOH_N3MA_2P25V				
Units		V				
Max Limit		2.35				
Min Limit		1.93				
krad	Serial #	PreTestHDR	PostTestHDR	Delta	Delta %	% of Limit Range
0	1	2.155	2.155	0.00	0.00%	0.03%
0	2	2.155	2.155	0.00	0.00%	0.02%
0	3	2.155	2.155	0.00	0.00%	0.00%
0	4	2.156	2.155	0.00	-0.01%	0.03%
10	5	2.155	2.155	0.00	-0.02%	0.09%
10	6	2.156	2.155	0.00	-0.02%	0.11%
10	7	2.155	2.155	0.00	-0.02%	0.08%
10	8	2.155	2.155	0.00	-0.01%	0.03%
10	9	2.156	2.155	0.00	-0.01%	0.07%
20	10	2.155	2.155	0.00	-0.01%	0.03%
20	11	2.156	2.155	0.00	-0.03%	0.14%
20	12	2.156	2.155	0.00	-0.02%	0.09%
20	13	2.156	2.155	0.00	-0.01%	0.07%
20	14	2.155	2.155	0.00	-0.02%	0.11%
30	15	2.156	2.155	0.00	-0.02%	0.09%
30	16	2.156	2.155	0.00	-0.02%	0.11%
30	17	2.156	2.155	0.00	-0.03%	0.14%
30	18	2.156	2.155	0.00	-0.03%	0.13%
30	19	2.156	2.155	0.00	-0.04%	0.18%
30	20	2.156	2.154	0.00	-0.09%	0.46%
31	15a	2.156	2.155	0.00	-0.03%	0.14%
31	16a	2.156	2.155	0.00	-0.02%	0.10%
31	17a	2.156	2.155	0.00	-0.03%	0.16%
31	18a	2.156	2.155	0.00	-0.02%	0.12%
31	19a	2.156	2.155	0.00	-0.04%	0.18%
31	20a	2.156	2.155	0.00	-0.03%	0.16%
50	21	2.156	2.139	-0.02	-0.78%	3.98%
50	22	2.156	2.138	-0.02	-0.79%	4.06%
50	23	2.156	2.138	-0.02	-0.83%	4.27%
50	24	2.156	2.138	-0.02	-0.80%	4.12%
50	25	2.156	2.138	-0.02	-0.80%	4.10%
	Max	2.156	2.155	0.00	0.00%	4.27%
	Average	2.156	2.153	0.00	-0.13%	0.64%
	Min	2.155	2.138	-0.02	-0.83%	0.00%
	Std Dev	0.000	0.006	0.01	0.27%	1.39%

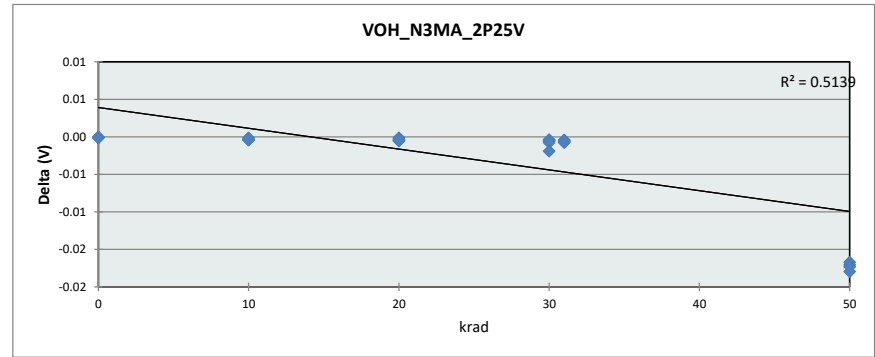

		VOH_N3MA_2P25V				
Units		V				
Max Limit		2.35				
Min Limit		1.93				
krad	0	10	20	30	31	50
LL	1.930	1.930	1.930	1.930	1.930	1.930
Min	2.155	2.155	2.155	2.154	2.155	2.138
Average	2.155	2.155	2.155	2.155	2.155	2.138
Max	2.155	2.155	2.155	2.155	2.155	2.139
UL	2.350	2.350	2.350	2.350	2.350	2.350

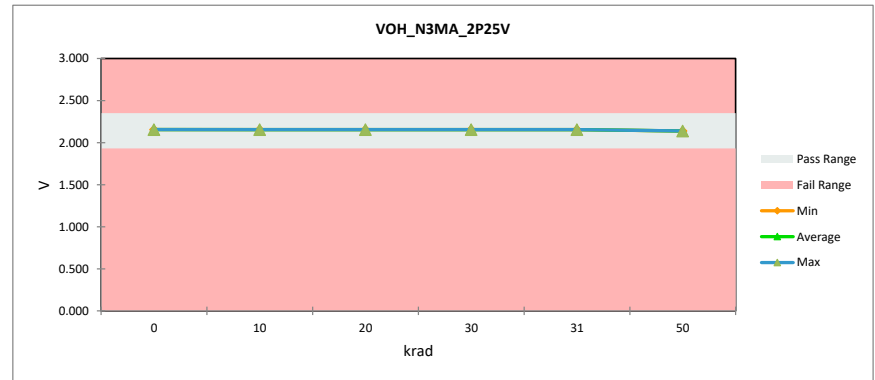

TID Report SN54SC8T138-SEP

		VOH_N5P5MA_3V				
		Units		V		
		Max Limit		3.1		
		Min Limit		2.49		
krad	Serial #	PreTestHDR	PostTestHDR	Delta	Delta %	% of Limit Range
0	1	2.853	2.852	0.00	-0.01%	0.05%
0	2	2.853	2.852	0.00	-0.02%	0.09%
0	3	2.853	2.852	0.00	-0.02%	0.08%
0	4	2.853	2.852	0.00	-0.02%	0.09%
10	5	2.853	2.852	0.00	-0.02%	0.11%
10	6	2.853	2.852	0.00	-0.02%	0.10%
10	7	2.853	2.852	0.00	-0.02%	0.10%
10	8	2.853	2.852	0.00	-0.02%	0.10%
10	9	2.853	2.852	0.00	-0.03%	0.15%
20	10	2.853	2.852	0.00	-0.02%	0.10%
20	11	2.853	2.852	0.00	-0.04%	0.17%
20	12	2.853	2.852	0.00	-0.03%	0.14%
20	13	2.853	2.852	0.00	-0.04%	0.18%
20	14	2.852	2.852	0.00	-0.03%	0.12%
30	15	2.853	2.852	0.00	-0.02%	0.09%
30	16	2.853	2.852	0.00	-0.02%	0.09%
30	17	2.853	2.852	0.00	-0.04%	0.17%
30	18	2.853	2.852	0.00	-0.03%	0.15%
30	19	2.853	2.852	0.00	-0.03%	0.14%
30	20	2.853	2.849	0.00	-0.15%	0.68%
31	15a	2.853	2.852	0.00	-0.04%	0.17%
31	16a	2.853	2.852	0.00	-0.03%	0.15%
31	17a	2.853	2.852	0.00	-0.04%	0.19%
31	18a	2.853	2.852	0.00	-0.04%	0.17%
31	19a	2.853	2.852	0.00	-0.03%	0.15%
31	20a	2.853	2.852	0.00	-0.05%	0.23%
50	21	2.853	2.841	-0.01	-0.41%	1.90%
50	22	2.853	2.841	-0.01	-0.42%	1.95%
50	23	2.853	2.841	-0.01	-0.43%	2.02%
50	24	2.853	2.841	-0.01	-0.42%	1.95%
50	25	2.853	2.841	-0.01	-0.41%	1.93%
	Max	2.853	2.852	0.00	-0.01%	2.02%
	Average	2.853	2.850	0.00	-0.08%	0.39%
	Min	2.852	2.841	-0.01	-0.43%	0.05%
	Std Dev	0.000	0.004	0.00	0.14%	0.63%

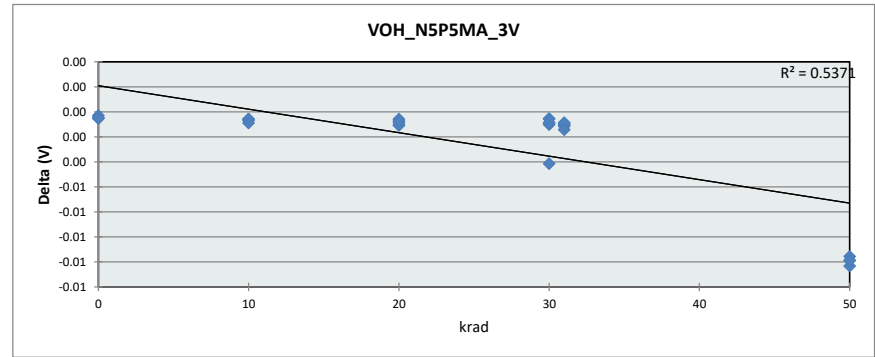

		VOH_N5P5MA_3V				
		Units		V		
		Max Limit		3.1		
		Min Limit		2.49		
krad	LL	Min	Average	Max	UL	
0	2.490	2.852	2.852	2.852	3.100	
10	2.490	2.852	2.852	2.852	3.100	
20	2.490	2.852	2.852	2.852	3.100	
30	2.490	2.849	2.852	2.852	3.100	
31	2.490	2.852	2.852	2.852	3.100	
50	2.490	2.841	2.841	2.841	3.100	

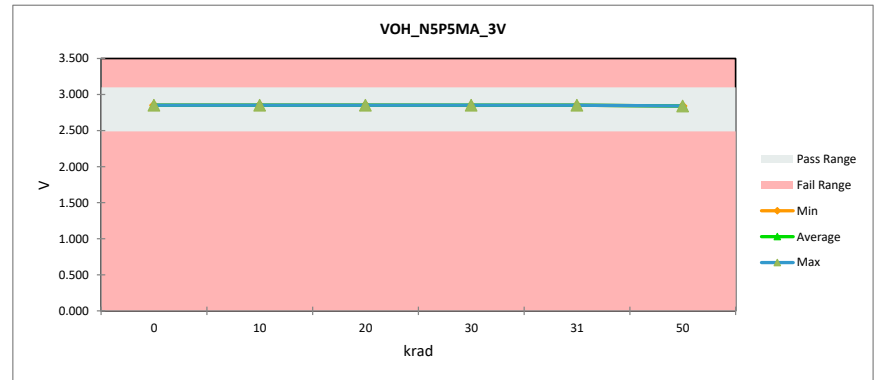

TID Report SN54SC8T138-SEP

		VOH_N8MA_4P5V				
		Units		V		
		Max Limit		4.6		
		Min Limit		3.95		
krad	Serial #	PreTestHDR	PostTestHDR	Delta	Delta %	% of Limit Range
0	1	4.318	4.318	0.00	0.00%	0.00%
0	2	4.318	4.318	0.00	0.00%	0.03%
0	3	4.318	4.318	0.00	-0.01%	0.03%
0	4	4.318	4.318	0.00	-0.01%	0.04%
10	5	4.318	4.318	0.00	-0.01%	0.04%
10	6	4.318	4.318	0.00	0.00%	0.03%
10	7	4.318	4.318	0.00	0.00%	0.02%
10	8	4.318	4.318	0.00	0.00%	0.02%
10	9	4.318	4.318	0.00	-0.01%	0.04%
20	10	4.318	4.318	0.00	0.00%	0.01%
20	11	4.319	4.319	0.00	-0.01%	0.09%
20	12	4.318	4.318	0.00	-0.01%	0.06%
20	13	4.319	4.318	0.00	-0.02%	0.11%
20	14	4.318	4.318	0.00	-0.01%	0.06%
30	15	4.319	4.318	0.00	-0.01%	0.07%
30	16	4.319	4.318	0.00	-0.01%	0.08%
30	17	4.318	4.318	0.00	-0.01%	0.07%
30	18	4.319	4.318	0.00	-0.02%	0.12%
30	19	4.319	4.318	0.00	-0.02%	0.12%
30	20	4.319	4.313	-0.01	-0.14%	0.93%
31	15a	4.319	4.318	0.00	-0.03%	0.17%
31	16a	4.319	4.318	0.00	-0.02%	0.11%
31	17a	4.318	4.318	0.00	-0.01%	0.10%
31	18a	4.319	4.318	0.00	-0.02%	0.14%
31	19a	4.319	4.318	0.00	-0.02%	0.14%
31	20a	4.319	4.318	0.00	-0.03%	0.20%
50	21	4.319	4.313	-0.01	-0.13%	0.89%
50	22	4.319	4.313	-0.01	-0.14%	0.95%
50	23	4.319	4.312	-0.01	-0.15%	1.03%
50	24	4.319	4.313	-0.01	-0.14%	0.95%
50	25	4.319	4.313	-0.01	-0.14%	0.94%
	Max	4.319	4.319	0.00	0.00%	1.03%
	Average	4.319	4.317	0.00	-0.03%	0.22%
	Min	4.318	4.312	-0.01	-0.15%	0.00%
	Std Dev	0.000	0.002	0.00	0.05%	0.34%

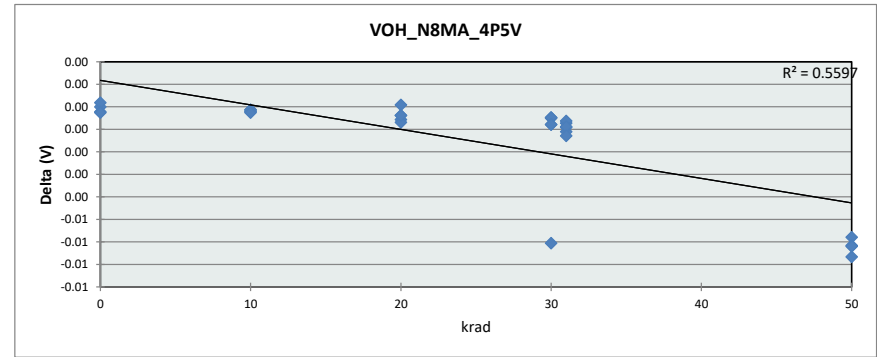

		VOH_N8MA_4P5V				
		Units		V		
		Max Limit		4.6		
		Min Limit		3.95		
krad	LL	Min	Average	Max	UL	
0	3.950	4.318	4.318	4.318	4.600	
10	3.950	4.318	4.318	4.318	4.600	
20	3.950	4.318	4.318	4.319	4.600	
30	3.950	4.313	4.317	4.318	4.600	
31	3.950	4.318	4.318	4.318	4.600	
50	3.950	4.312	4.313	4.313	4.600	

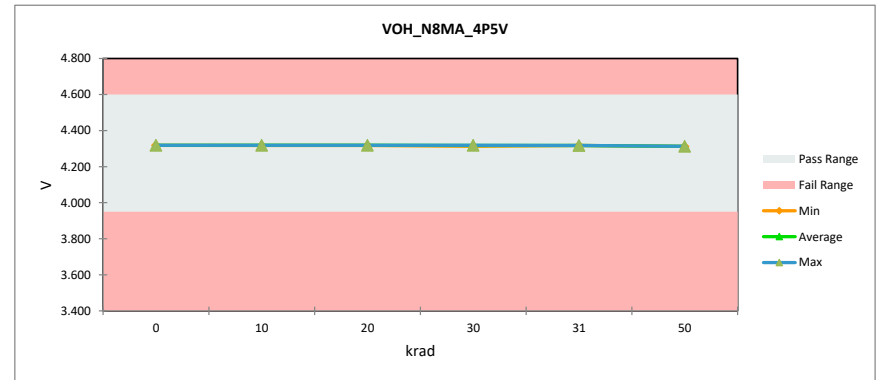

TID Report

SN54SC8T138-SEP

		VOH_N24MA_5P5V					
Units		V					
Max Limit		5.6					
Min Limit		3.15					
krad	Serial #	PreTestHDR	PostTestHDR	Delta	Delta %	% of Limit Range	
0	1	4.977	4.977	0.00	0.00%	0.00%	
0	2	4.977	4.977	0.00	-0.01%	0.01%	
0	3	4.977	4.976	0.00	-0.02%	0.03%	
0	4	4.978	4.977	0.00	-0.02%	0.03%	
10	5	4.977	4.976	0.00	-0.02%	0.04%	
10	6	4.978	4.977	0.00	-0.02%	0.05%	
10	7	4.977	4.976	0.00	-0.02%	0.04%	
10	8	4.977	4.976	0.00	-0.02%	0.05%	
10	9	4.977	4.976	0.00	-0.03%	0.07%	
20	10	4.977	4.977	0.00	0.00%	0.00%	
20	11	4.979	4.978	0.00	-0.03%	0.06%	
20	12	4.977	4.976	0.00	-0.03%	0.05%	
20	13	4.979	4.977	0.00	-0.04%	0.08%	
20	14	4.977	4.976	0.00	-0.03%	0.06%	
30	15	4.979	4.978	0.00	-0.02%	0.05%	
30	16	4.978	4.977	0.00	-0.03%	0.05%	
30	17	4.977	4.976	0.00	-0.02%	0.05%	
30	18	4.978	4.976	0.00	-0.04%	0.08%	
30	19	4.979	4.977	0.00	-0.04%	0.08%	
30	20	4.979	4.961	-0.02	-0.36%	0.74%	
31	15a	4.979	4.975	0.00	-0.08%	0.15%	
31	16a	4.978	4.976	0.00	-0.05%	0.11%	
31	17a	4.977	4.975	0.00	-0.05%	0.09%	
31	18a	4.978	4.975	0.00	-0.05%	0.10%	
31	19a	4.979	4.976	0.00	-0.05%	0.11%	
31	20a	4.979	4.975	0.00	-0.07%	0.15%	
50	21	4.978	4.976	0.00	-0.06%	0.11%	
50	22	4.979	4.976	0.00	-0.06%	0.12%	
50	23	4.979	4.976	0.00	-0.06%	0.12%	
50	24	4.979	4.976	0.00	-0.05%	0.10%	
50	25	4.979	4.976	0.00	-0.06%	0.13%	
Max		4.979	4.978	0.00	0.00%	0.74%	
Average		4.978	4.976	0.00	-0.05%	0.09%	
Min		4.977	4.961	-0.02	-0.36%	0.00%	
Std Dev		0.001	0.003	0.00	0.06%	0.13%	

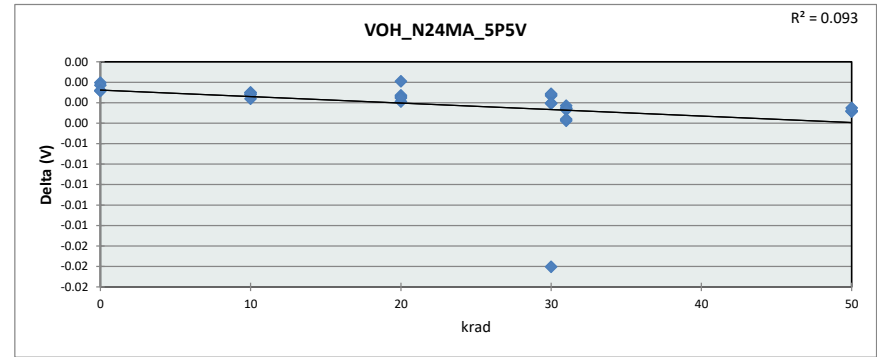

		VOH_N24MA_5P5V					
Units		V					
Max Limit		5.6					
Min Limit		3.15					
krad	LL	Min	Average	Max	UL		
0	3.150	4.976	4.977	4.977	5.600		
10	3.150	4.976	4.976	4.977	5.600		
20	3.150	4.976	4.977	4.978	5.600		
30	3.150	4.961	4.974	4.978	5.600		
31	3.150	4.975	4.975	4.976	5.600		
50	3.150	4.976	4.976	4.976	5.600		

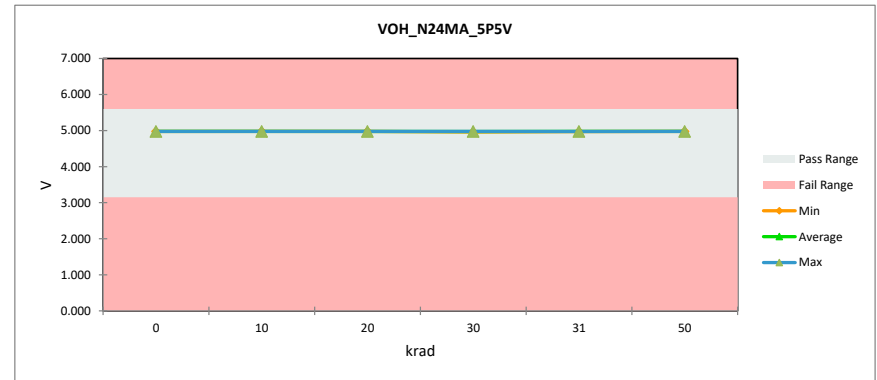

TID Report SN54SC8T138-SEP

		VOH_N50UA_1P2V				
Units		V				
Max Limit		1.3				
Min Limit		1				
krad	Serial #	PreTestHDR	PostTestHDR	Delta	Delta %	% of Limit Range
0	1	1.197	1.197	0.00	0.00%	0.01%
0	2	1.197	1.197	0.00	0.00%	0.01%
0	3	1.197	1.197	0.00	0.00%	0.01%
0	4	1.197	1.197	0.00	0.01%	0.03%
10	5	1.197	1.197	0.00	0.00%	0.01%
10	6	1.197	1.197	0.00	0.00%	0.02%
10	7	1.197	1.197	0.00	-0.01%	0.03%
10	8	1.197	1.197	0.00	0.00%	0.01%
10	9	1.197	1.197	0.00	0.01%	0.03%
20	10	1.197	1.197	0.00	0.00%	0.00%
20	11	1.197	1.197	0.00	-0.01%	0.04%
20	12	1.197	1.197	0.00	-0.01%	0.02%
20	13	1.197	1.197	0.00	0.01%	0.03%
20	14	1.197	1.197	0.00	0.00%	0.00%
30	15	1.197	1.192	0.00	-0.38%	1.51%
30	16	1.197	1.192	0.00	-0.38%	1.51%
30	17	1.197	1.191	-0.01	-0.44%	1.77%
30	18	1.197	1.192	-0.01	-0.42%	1.68%
30	19	1.197	1.191	-0.01	-0.49%	1.94%
30	20	1.197	1.192	0.00	-0.41%	1.62%
31	15a	1.197	1.196	0.00	-0.03%	0.12%
31	16a	1.197	1.196	0.00	-0.02%	0.10%
31	17a	1.197	1.196	0.00	-0.04%	0.16%
31	18a	1.197	1.196	0.00	-0.04%	0.18%
31	19a	1.197	1.196	0.00	-0.04%	0.16%
31	20a	1.197	1.196	0.00	-0.04%	0.16%
50	21	1.197	-0.002	-1.20	-100.20%	399.66%
50	22	1.197	-0.003	-1.20	-100.22%	399.71%
50	23	1.197	-0.002	-1.20	-100.19%	399.67%
50	24	1.197	-0.003	-1.20	-100.21%	399.74%
50	25	1.197	-0.002	-1.20	-100.21%	399.70%
Max		1.197	1.197	0.00	0.01%	399.74%
Average		1.197	1.036	-0.16	-13.45%	53.66%
Min		1.197	-0.003	-1.20	-100.22%	0.00%
Std Dev		0.000	0.414	0.41	34.61%	138.05%

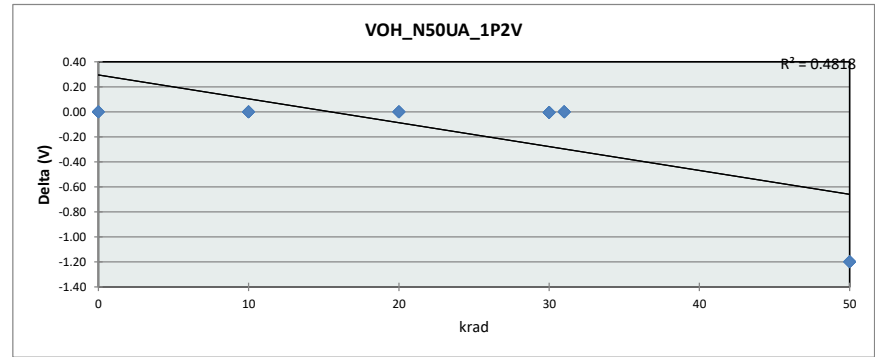

		VOH_N50UA_1P2V					
Units		V					
Max Limit		1.3					
Min Limit		1					
krad	0	10	20	30	31	50	
LL	1.000	1.000	1.000	1.000	1.000	1.000	
Min	1.197	1.197	1.197	1.191	1.196	-0.003	
Average	1.197	1.197	1.197	1.192	1.196	-0.002	
Max	1.197	1.197	1.197	1.192	1.196	-0.002	
UL	1.300	1.300	1.300	1.300	1.300	1.300	

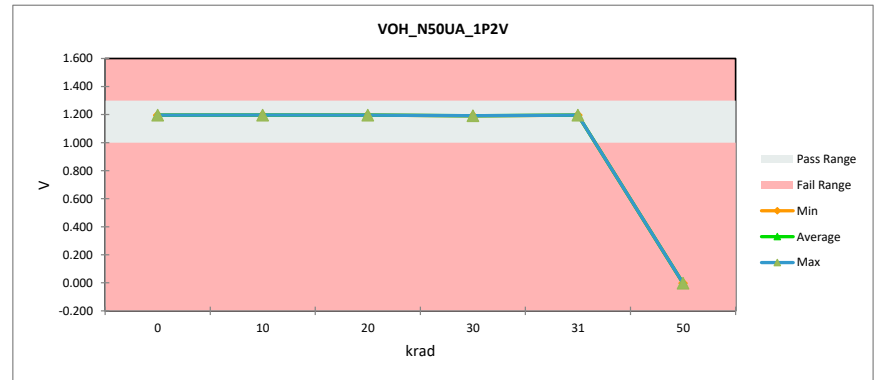

TID Report SN54SC8T138-SEP

VOH_N50UA_5P5V						
Units	V					
Max Limit	5.6					
Min Limit	5.3					
krad	Serial #	PreTestHDR	PostTestHDR	Delta	Delta %	% of Limit Range
0	1	5.498	5.498	0.00	0.00%	0.05%
0	2	5.498	5.498	0.00	0.00%	0.08%
0	3	5.498	5.498	0.00	0.00%	0.01%
0	4	5.498	5.498	0.00	0.00%	0.04%
10	5	5.498	5.498	0.00	0.01%	0.10%
10	6	5.498	5.498	0.00	0.00%	0.02%
10	7	5.498	5.498	0.00	0.00%	0.08%
10	8	5.498	5.498	0.00	0.00%	0.02%
10	9	5.498	5.498	0.00	0.00%	0.03%
20	10	5.498	5.498	0.00	0.00%	0.07%
20	11	5.498	5.498	0.00	0.00%	0.07%
20	12	5.498	5.498	0.00	0.00%	0.07%
20	13	5.498	5.498	0.00	0.00%	0.01%
20	14	5.498	5.498	0.00	0.00%	0.05%
30	15	5.498	5.496	0.00	-0.04%	0.66%
30	16	5.498	5.496	0.00	-0.03%	0.62%
30	17	5.498	5.496	0.00	-0.04%	0.69%
30	18	5.498	5.496	0.00	-0.04%	0.72%
30	19	5.498	5.495	0.00	-0.05%	0.94%
30	20	5.498	5.496	0.00	-0.04%	0.69%
31	15a	5.498	5.498	0.00	0.00%	0.04%
31	16a	5.498	5.498	0.00	0.00%	0.04%
31	17a	5.498	5.498	0.00	0.00%	0.06%
31	18a	5.498	5.498	0.00	0.00%	0.04%
31	19a	5.498	5.498	0.00	0.00%	0.07%
31	20a	5.498	5.498	0.00	0.00%	0.01%
50	21	5.498	5.484	-0.01	-0.26%	4.77%
50	22	5.498	5.484	-0.01	-0.27%	4.86%
50	23	5.498	5.483	-0.01	-0.27%	4.94%
50	24	5.498	5.484	-0.01	-0.26%	4.80%
50	25	5.498	5.484	-0.01	-0.26%	4.80%
	Max	5.498	5.498	0.00	0.01%	4.94%
	Average	5.498	5.496	0.00	-0.04%	0.82%
	Min	5.498	5.483	-0.01	-0.27%	0.01%
	Std Dev	0.000	0.005	0.00	0.09%	1.63%

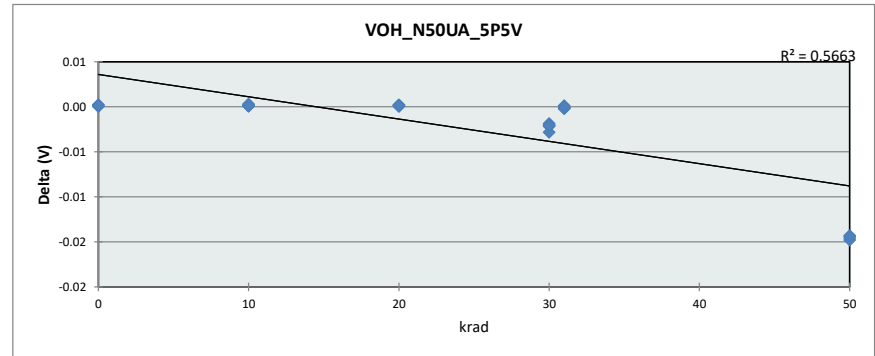

VOH_N50UA_5P5V						
Units	V					
Max Limit	5.6					
Min Limit	5.3					
krad	0	10	20	30	31	50
LL	5.300	5.300	5.300	5.300	5.300	5.300
Min	5.498	5.498	5.498	5.495	5.498	5.483
Average	5.498	5.498	5.498	5.496	5.498	5.484
Max	5.498	5.498	5.498	5.496	5.498	5.484
UL	5.600	5.600	5.600	5.600	5.600	5.600

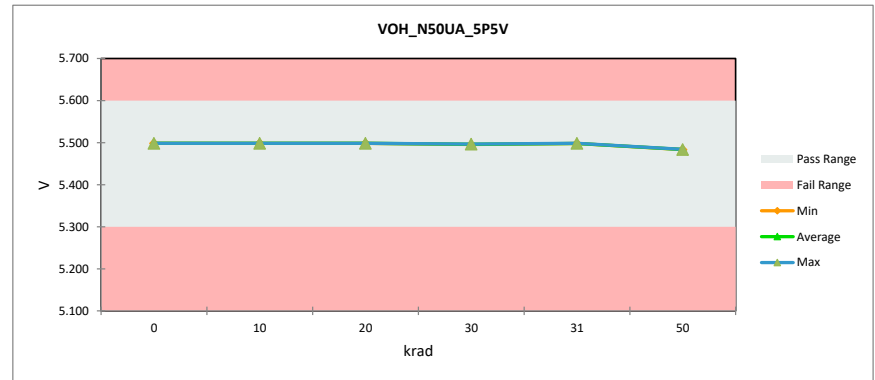

TID Report SN54SC8T138-SEP

		VOL_1MA_1P2V					
Units		V					
Max Limit		0.2					
Min Limit		-0.001					
krad	Serial #	PreTestHDR	PostTestHDR	Delta	Delta %	% of Limit Range	
0	1	0.047	0.047	0.00	0.36%	0.08%	
0	2	0.047	0.047	0.00	0.49%	0.11%	
0	3	0.047	0.047	0.00	0.83%	0.19%	
0	4	0.047	0.047	0.00	0.42%	0.10%	
10	5	0.047	0.047	0.00	-0.07%	0.02%	
10	6	0.047	0.047	0.00	0.13%	0.03%	
10	7	0.047	0.047	0.00	0.16%	0.04%	
10	8	0.047	0.047	0.00	0.02%	0.01%	
10	9	0.047	0.047	0.00	0.12%	0.03%	
20	10	0.047	0.047	0.00	-0.87%	0.20%	
20	11	0.047	0.047	0.00	-0.67%	0.16%	
20	12	0.047	0.046	0.00	-0.90%	0.21%	
20	13	0.047	0.047	0.00	-1.21%	0.28%	
20	14	0.046	0.046	0.00	-0.25%	0.06%	
30	15	0.047	0.046	0.00	-1.47%	0.34%	
30	16	0.047	0.046	0.00	-2.00%	0.47%	
30	17	0.047	0.046	0.00	-2.41%	0.56%	
30	18	0.047	0.045	0.00	-2.55%	0.59%	
30	19	0.047	0.046	0.00	-1.80%	0.42%	
30	20	0.047	0.046	0.00	-2.20%	0.51%	
31	15a	0.047	0.047	0.00	0.06%	0.01%	
31	16a	0.047	0.047	0.00	-0.51%	0.12%	
31	17a	0.047	0.046	0.00	-0.94%	0.22%	
31	18a	0.047	0.046	0.00	-0.88%	0.20%	
31	19a	0.047	0.047	0.00	-0.60%	0.14%	
31	20a	0.047	0.047	0.00	-0.87%	0.20%	
50	21	0.047	0.045	0.00	-4.21%	0.98%	
50	22	0.047	0.045	0.00	-4.33%	1.01%	
50	23	0.047	0.045	0.00	-4.21%	0.98%	
50	24	0.047	0.045	0.00	-3.74%	0.87%	
50	25	0.047	0.045	0.00	-4.11%	0.97%	
Max		0.047	0.047	0.00	0.83%	1.01%	
Average		0.047	0.046	0.00	-1.14%	0.31%	
Min		0.046	0.045	0.00	-4.33%	0.01%	
Std Dev		0.000	0.001	0.00	1.48%	0.31%	

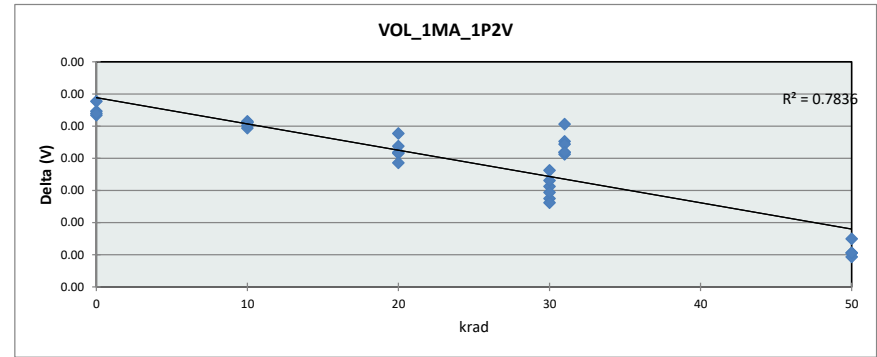

		VOL_1MA_1P2V					
Units		V					
Max Limit		0.2					
Min Limit		-0.001					
krad		0	10	20	30	31	50
LL		-0.001	-0.001	-0.001	-0.001	-0.001	-0.001
Min		0.047	0.047	0.046	0.045	0.046	0.045
Average		0.047	0.047	0.047	0.046	0.047	0.045
Max		0.047	0.047	0.047	0.046	0.047	0.045
UL		0.200	0.200	0.200	0.200	0.200	0.200

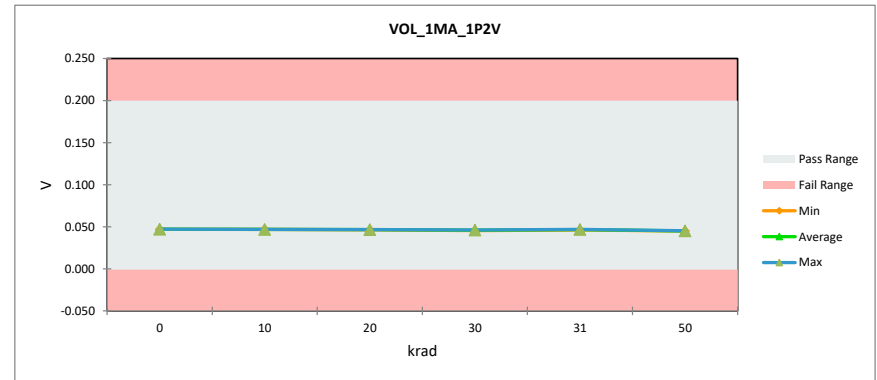

TID Report SN54SC8T138-SEP

		VOL_2MA_1P65V				
Units		V				
Max Limit		0.25				
Min Limit		-0.001				
krad	Serial #	PreTestHDR	PostTestHDR	Delta	Delta %	% of Limit Range
0	1	0.059	0.059	0.00	0.67%	0.16%
0	2	0.059	0.059	0.00	0.53%	0.12%
0	3	0.059	0.059	0.00	0.55%	0.13%
0	4	0.059	0.059	0.00	0.83%	0.19%
10	5	0.059	0.059	0.00	0.51%	0.12%
10	6	0.059	0.059	0.00	0.62%	0.15%
10	7	0.059	0.059	0.00	0.11%	0.02%
10	8	0.059	0.059	0.00	0.48%	0.11%
10	9	0.059	0.059	0.00	0.19%	0.05%
20	10	0.059	0.059	0.00	-0.18%	0.04%
20	11	0.059	0.059	0.00	-0.12%	0.03%
20	12	0.059	0.059	0.00	-0.22%	0.05%
20	13	0.059	0.059	0.00	-0.36%	0.08%
20	14	0.059	0.059	0.00	0.14%	0.03%
30	15	0.059	0.058	0.00	-0.87%	0.20%
30	16	0.059	0.058	0.00	-0.92%	0.22%
30	17	0.059	0.058	0.00	-1.03%	0.24%
30	18	0.059	0.058	0.00	-0.93%	0.22%
30	19	0.059	0.059	0.00	-0.87%	0.20%
30	20	0.059	0.059	0.00	-0.71%	0.17%
31	15a	0.059	0.059	0.00	0.58%	0.14%
31	16a	0.059	0.059	0.00	0.09%	0.02%
31	17a	0.059	0.059	0.00	-0.07%	0.02%
31	18a	0.059	0.059	0.00	0.09%	0.02%
31	19a	0.059	0.059	0.00	-0.05%	0.01%
31	20a	0.059	0.059	0.00	-0.11%	0.03%
50	21	0.059	0.058	0.00	-1.56%	0.37%
50	22	0.059	0.058	0.00	-1.35%	0.32%
50	23	0.059	0.058	0.00	-1.61%	0.38%
50	24	0.059	0.058	0.00	-1.61%	0.38%
50	25	0.059	0.058	0.00	-1.66%	0.39%
	Max	0.059	0.059	0.00	0.83%	0.38%
	Average	0.059	0.059	0.00	-0.24%	0.14%
	Min	0.059	0.058	0.00	-1.61%	0.01%
	Std Dev	0.000	0.000	0.00	0.74%	0.11%

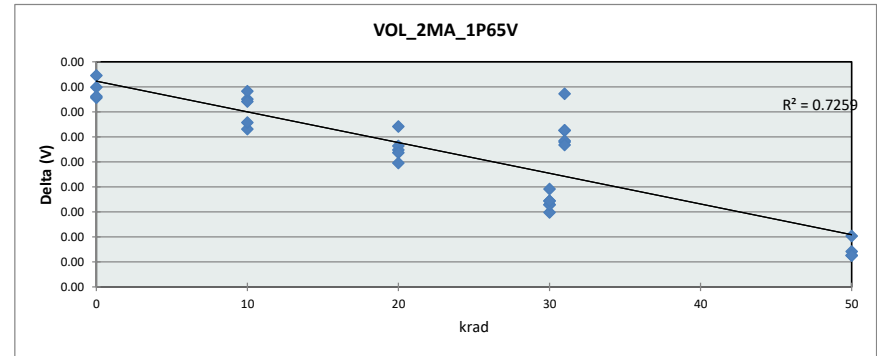

		VOL_2MA_1P65V					
Units		V					
Max Limit		0.25					
Min Limit		-0.001					
krad		0	10	20	30	31	50
LL		-0.001	-0.001	-0.001	-0.001	-0.001	-0.001
Min		0.059	0.059	0.059	0.058	0.059	0.058
Average		0.059	0.059	0.059	0.058	0.059	0.058
Max		0.059	0.059	0.059	0.059	0.059	0.058
UL		0.250	0.250	0.250	0.250	0.250	0.250

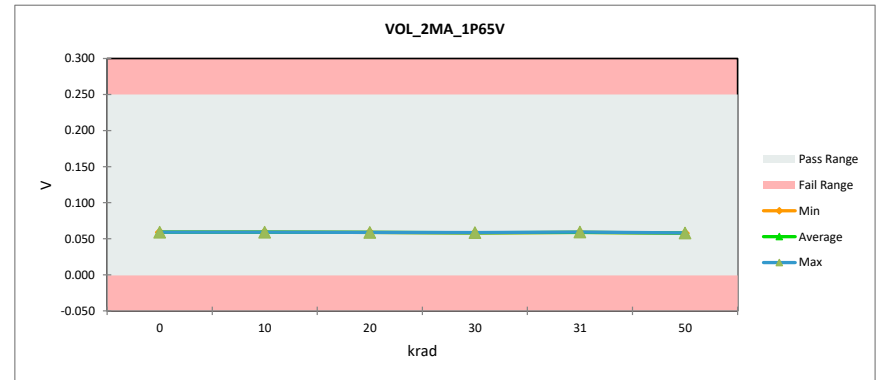

TID Report SN54SC8T138-SEP

		VOL_3MA_2P25V					
Units		V					
Max Limit		0.2					
Min Limit		-0.001					
krad	Serial #	PreTestHDR	PostTestHDR	Delta	Delta %	% of Limit Range	
0	1	0.068	0.068	0.00	0.33%	0.11%	
0	2	0.068	0.069	0.00	0.56%	0.19%	
0	3	0.068	0.068	0.00	0.24%	0.08%	
0	4	0.068	0.068	0.00	0.51%	0.17%	
10	5	0.068	0.068	0.00	0.19%	0.06%	
10	6	0.068	0.068	0.00	0.37%	0.13%	
10	7	0.068	0.069	0.00	0.34%	0.12%	
10	8	0.068	0.069	0.00	0.65%	0.22%	
10	9	0.068	0.069	0.00	0.56%	0.19%	
20	10	0.068	0.068	0.00	-0.08%	0.03%	
20	11	0.068	0.068	0.00	0.10%	0.03%	
20	12	0.068	0.069	0.00	0.28%	0.10%	
20	13	0.068	0.068	0.00	-0.01%	0.00%	
20	14	0.068	0.068	0.00	0.28%	0.10%	
30	15	0.068	0.068	0.00	-0.36%	0.12%	
30	16	0.068	0.068	0.00	-0.49%	0.17%	
30	17	0.068	0.068	0.00	-0.31%	0.11%	
30	18	0.068	0.068	0.00	-0.31%	0.11%	
30	19	0.068	0.068	0.00	-0.27%	0.09%	
30	20	0.068	0.068	0.00	-0.13%	0.04%	
31	15a	0.068	0.069	0.00	0.70%	0.24%	
31	16a	0.068	0.068	0.00	0.19%	0.07%	
31	17a	0.068	0.068	0.00	0.33%	0.11%	
31	18a	0.068	0.068	0.00	0.38%	0.13%	
31	19a	0.068	0.069	0.00	0.28%	0.10%	
31	20a	0.068	0.068	0.00	0.19%	0.06%	
50	21	0.068	0.068	0.00	-0.82%	0.28%	
50	22	0.068	0.068	0.00	-0.68%	0.23%	
50	23	0.068	0.068	0.00	-0.77%	0.26%	
50	24	0.068	0.068	0.00	-1.00%	0.34%	
50	25	0.068	0.068	0.00	-1.04%	0.35%	
Max		0.068	0.069	0.00	0.70%	0.34%	
Average		0.068	0.068	0.00	0.04%	0.13%	
Min		0.068	0.068	0.00	-1.00%	0.00%	
Std Dev		0.000	0.000	0.00	0.46%	0.08%	

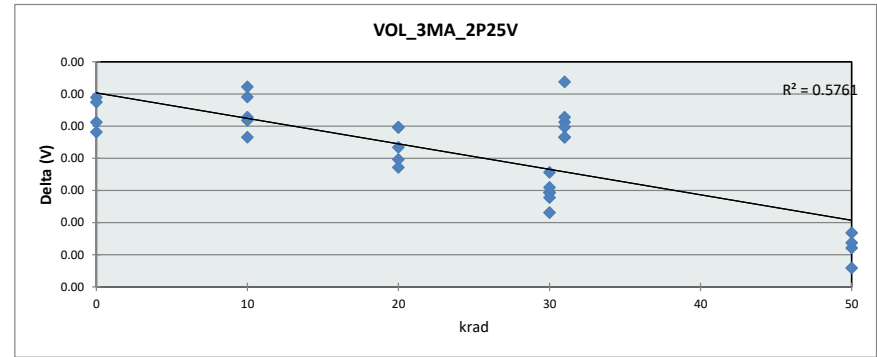

		VOL_3MA_2P25V					
Units		V					
Max Limit		0.2					
Min Limit		-0.001					
krad		0	10	20	30	31	50
LL		-0.001	-0.001	-0.001	-0.001	-0.001	-0.001
Min		0.068	0.068	0.068	0.068	0.068	0.068
Average		0.068	0.069	0.068	0.068	0.068	0.068
Max		0.069	0.069	0.069	0.068	0.069	0.068
UL		0.200	0.200	0.200	0.200	0.200	0.200

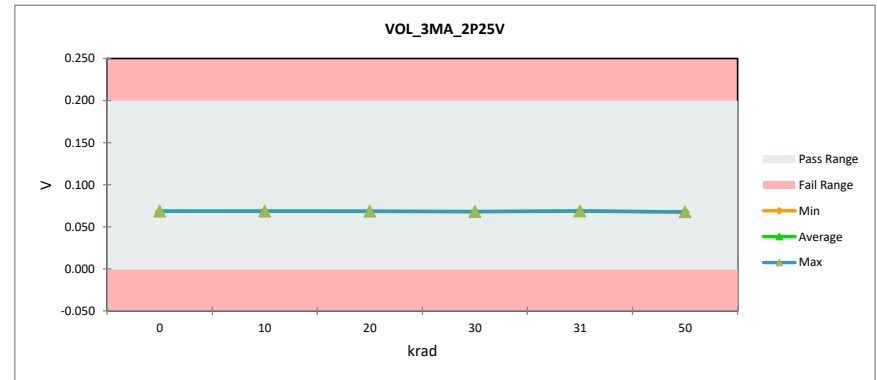

TID Report SN54SC8T138-SEP

		VOL_5P5MA_3V				
		Units		V		
		Max Limit		0.25		
		Min Limit		-0.001		
krad	Serial #	PreTestHDR	PostTestHDR	Delta	Delta %	% of Limit Range
0	1	0.107	0.107	0.00	0.24%	0.10%
0	2	0.107	0.107	0.00	0.24%	0.10%
0	3	0.107	0.107	0.00	0.27%	0.12%
0	4	0.107	0.107	0.00	0.16%	0.07%
10	5	0.107	0.107	0.00	0.16%	0.07%
10	6	0.107	0.107	0.00	0.10%	0.04%
10	7	0.107	0.107	0.00	0.24%	0.10%
10	8	0.107	0.107	0.00	0.39%	0.17%
10	9	0.107	0.107	0.00	-0.25%	0.11%
20	10	0.107	0.107	0.00	-0.34%	0.14%
20	11	0.107	0.107	0.00	-0.14%	0.06%
20	12	0.107	0.107	0.00	0.16%	0.07%
20	13	0.107	0.107	0.00	-0.05%	0.02%
20	14	0.107	0.107	0.00	0.07%	0.03%
30	15	0.107	0.107	0.00	-0.46%	0.19%
30	16	0.107	0.107	0.00	-0.60%	0.26%
30	17	0.107	0.107	0.00	-0.22%	0.10%
30	18	0.107	0.107	0.00	-0.11%	0.05%
30	19	0.107	0.107	0.00	-0.22%	0.10%
30	20	0.107	0.107	0.00	-0.05%	0.02%
31	15a	0.107	0.108	0.00	0.80%	0.34%
31	16a	0.107	0.108	0.00	0.21%	0.09%
31	17a	0.107	0.107	0.00	0.04%	0.02%
31	18a	0.107	0.107	0.00	0.21%	0.09%
31	19a	0.107	0.107	0.00	0.04%	0.02%
31	20a	0.107	0.107	0.00	0.21%	0.09%
50	21	0.107	0.106	0.00	-0.34%	0.15%
50	22	0.107	0.106	0.00	-0.58%	0.25%
50	23	0.107	0.107	0.00	-0.46%	0.19%
50	24	0.107	0.106	0.00	-0.55%	0.23%
50	25	0.107	0.107	0.00	-0.43%	0.18%
Max		0.107	0.108	0.00	0.80%	0.34%
Average		0.107	0.107	0.00	-0.03%	0.11%
Min		0.107	0.106	0.00	-0.60%	0.02%
Std Dev		0.000	0.000	0.00	0.33%	0.08%

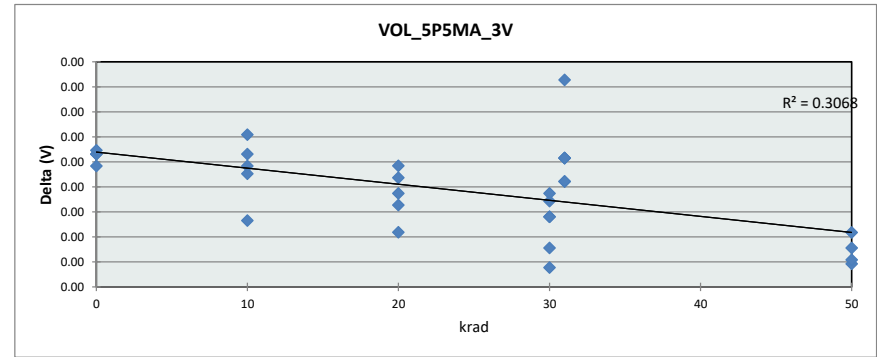

		VOL_5P5MA_3V					
		Units		V			
		Max Limit		0.25			
		Min Limit		-0.001			
krad		0	10	20	30	31	50
LL		-0.001	-0.001	-0.001	-0.001	-0.001	-0.001
Min		0.107	0.107	0.107	0.107	0.107	0.106
Average		0.107	0.107	0.107	0.107	0.107	0.106
Max		0.107	0.107	0.107	0.107	0.108	0.107
UL		0.250	0.250	0.250	0.250	0.250	0.250

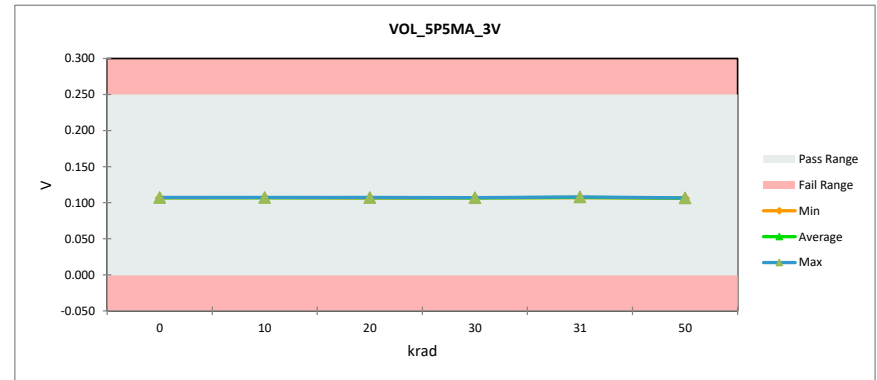

TID Report SN54SC8T138-SEP

		VOL_8MA_4P5V					
		Units		V			
		Max Limit		0.35			
		Min Limit		-0.001			
krad	Serial #	PreTestHDR	PostTestHDR	Delta	Delta %	% of Limit Range	
0	1	0.135	0.135	0.00	0.09%	0.03%	
0	2	0.135	0.136	0.00	0.23%	0.09%	
0	3	0.135	0.135	0.00	0.28%	0.11%	
0	4	0.135	0.135	0.00	0.04%	0.02%	
10	5	0.135	0.135	0.00	0.00%	0.00%	
10	6	0.135	0.135	0.00	0.07%	0.03%	
10	7	0.136	0.136	0.00	0.07%	0.03%	
10	8	0.135	0.135	0.00	0.25%	0.10%	
10	9	0.136	0.135	0.00	-0.39%	0.15%	
20	10	0.136	0.135	0.00	-0.32%	0.13%	
20	11	0.135	0.135	0.00	-0.16%	0.06%	
20	12	0.136	0.136	0.00	0.04%	0.02%	
20	13	0.135	0.135	0.00	-0.09%	0.04%	
20	14	0.135	0.135	0.00	0.02%	0.01%	
30	15	0.135	0.135	0.00	-0.32%	0.13%	
30	16	0.136	0.135	0.00	-0.55%	0.21%	
30	17	0.135	0.135	0.00	-0.02%	0.01%	
30	18	0.135	0.135	0.00	0.04%	0.02%	
30	19	0.135	0.135	0.00	-0.02%	0.01%	
30	20	0.135	0.135	0.00	0.07%	0.03%	
31	15a	0.135	0.137	0.00	0.88%	0.34%	
31	16a	0.136	0.136	0.00	0.02%	0.01%	
31	17a	0.135	0.136	0.00	0.21%	0.08%	
31	18a	0.135	0.135	0.00	0.18%	0.07%	
31	19a	0.135	0.136	0.00	0.09%	0.04%	
31	20a	0.135	0.135	0.00	0.11%	0.04%	
50	21	0.135	0.135	0.00	-0.12%	0.05%	
50	22	0.135	0.135	0.00	-0.28%	0.11%	
50	23	0.135	0.135	0.00	0.00%	0.00%	
50	24	0.135	0.135	0.00	-0.23%	0.09%	
50	25	0.135	0.135	0.00	-0.19%	0.07%	
Max		0.136	0.137	0.00	0.88%	0.34%	
Average		0.135	0.135	0.00	0.01%	0.07%	
Min		0.135	0.135	0.00	-0.55%	0.00%	
Std Dev		0.000	0.000	0.00	0.26%	0.07%	

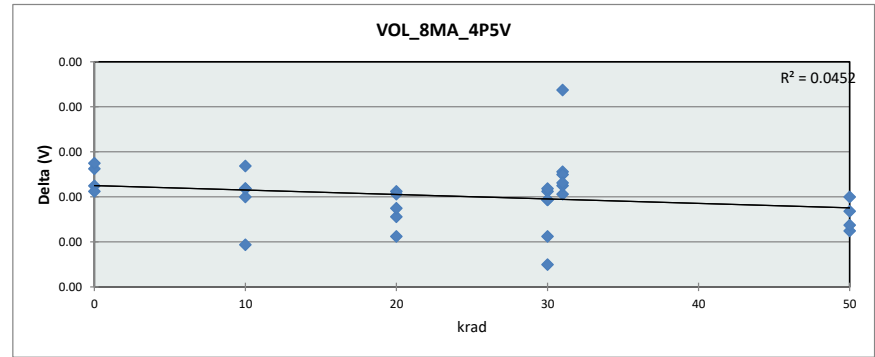

		VOL_8MA_4P5V					
		Units		V			
		Max Limit		0.35			
		Min Limit		-0.001			
krad		0	10	20	30	31	50
LL		-0.001	-0.001	-0.001	-0.001	-0.001	-0.001
Min		0.135	0.135	0.135	0.135	0.135	0.135
Average		0.135	0.135	0.135	0.135	0.136	0.135
Max		0.136	0.136	0.136	0.135	0.137	0.135
UL		0.350	0.350	0.350	0.350	0.350	0.350

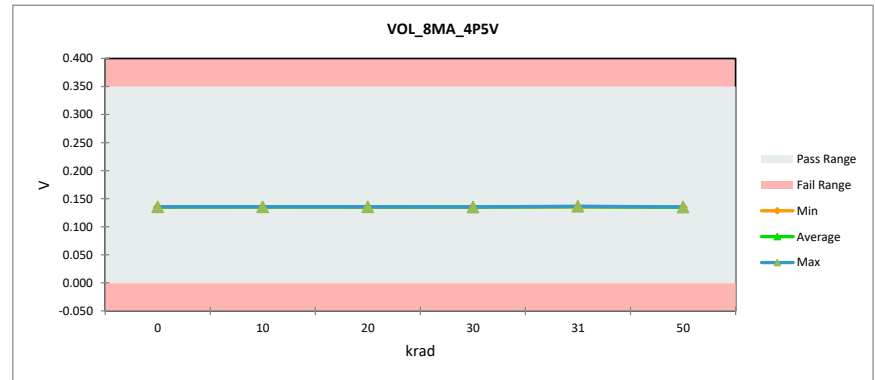

TID Report

SN54SC8T138-SEP

		VOL_24MA_5P5V				
		Units		V		
		Max Limit		0.75		
		Min Limit		-0.001		
krad	Serial #	PreTestHDR	PostTestHDR	Delta	Delta %	% of Limit Range
0	1	0.390	0.390	0.00	-0.06%	0.03%
0	2	0.390	0.391	0.00	0.11%	0.06%
0	3	0.390	0.390	0.00	0.03%	0.01%
0	4	0.389	0.390	0.00	0.05%	0.03%
10	5	0.390	0.390	0.00	-0.05%	0.03%
10	6	0.391	0.391	0.00	0.00%	0.00%
10	7	0.391	0.391	0.00	0.03%	0.01%
10	8	0.390	0.390	0.00	0.09%	0.05%
10	9	0.391	0.390	0.00	-0.30%	0.16%
20	10	0.392	0.390	0.00	-0.53%	0.28%
20	11	0.390	0.389	0.00	-0.30%	0.15%
20	12	0.392	0.391	0.00	-0.05%	0.02%
20	13	0.390	0.389	0.00	-0.04%	0.02%
20	14	0.391	0.391	0.00	-0.01%	0.00%
30	15	0.391	0.389	0.00	-0.37%	0.19%
30	16	0.392	0.390	0.00	-0.47%	0.24%
30	17	0.390	0.390	0.00	-0.08%	0.04%
30	18	0.390	0.390	0.00	-0.15%	0.08%
30	19	0.391	0.390	0.00	-0.16%	0.08%
30	20	0.390	0.390	0.00	0.03%	0.01%
31	15a	0.391	0.394	0.00	0.86%	0.45%
31	16a	0.392	0.392	0.00	0.08%	0.04%
31	17a	0.390	0.391	0.00	0.20%	0.10%
31	18a	0.390	0.391	0.00	0.19%	0.10%
31	19a	0.391	0.391	0.00	0.07%	0.04%
31	20a	0.390	0.390	0.00	0.03%	0.02%
50	21	0.390	0.389	0.00	-0.17%	0.09%
50	22	0.389	0.388	0.00	-0.29%	0.15%
50	23	0.390	0.390	0.00	-0.09%	0.04%
50	24	0.390	0.389	0.00	-0.23%	0.12%
50	25	0.390	0.389	0.00	-0.27%	0.14%
Max		0.392	0.394	0.00	0.86%	0.45%
Average		0.390	0.390	0.00	-0.05%	0.09%
Min		0.389	0.388	0.00	-0.53%	0.00%
Std Dev		0.001	0.001	0.00	0.25%	0.10%

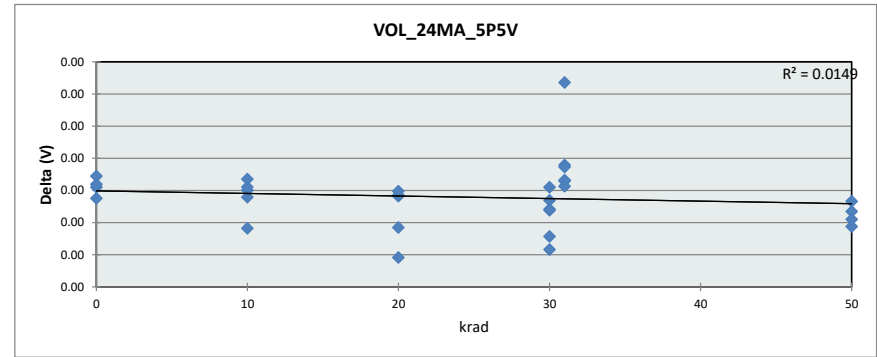

		VOL_24MA_5P5V					
		Units		V			
		Max Limit		0.75			
		Min Limit		-0.001			
krad		0	10	20	30	31	50
LL		-0.001	-0.001	-0.001	-0.001	-0.001	-0.001
Min		0.390	0.390	0.389	0.389	0.390	0.388
Average		0.390	0.390	0.390	0.390	0.392	0.389
Max		0.391	0.391	0.391	0.390	0.394	0.390
UL		0.750	0.750	0.750	0.750	0.750	0.750

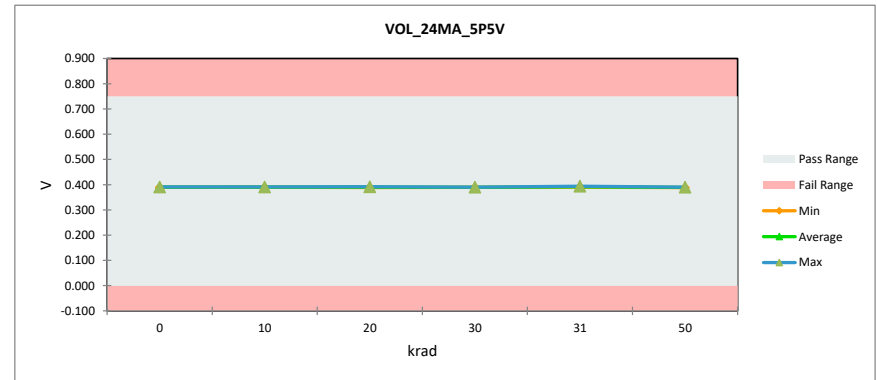

TID Report SN54SC8T138-SEP

		VOL_50UA_1P2V				
Units		V				
Max Limit		0.1				
Min Limit		-0.001				
krad	Serial #	PreTestHDR	PostTestHDR	Delta	Delta %	% of Limit Range
0	1	0.002	0.002	0.00	7.02%	0.15%
0	2	0.002	0.002	0.00	12.74%	0.28%
0	3	0.002	0.002	0.00	15.90%	0.33%
0	4	0.002	0.002	0.00	17.54%	0.35%
10	5	0.002	0.002	0.00	14.80%	0.31%
10	6	0.002	0.002	0.00	13.50%	0.28%
10	7	0.002	0.002	0.00	14.48%	0.30%
10	8	0.002	0.002	0.00	16.76%	0.35%
10	9	0.002	0.002	0.00	13.30%	0.28%
20	10	0.002	0.002	0.00	15.67%	0.33%
20	11	0.002	0.002	0.00	15.02%	0.31%
20	12	0.002	0.002	0.00	21.50%	0.43%
20	13	0.002	0.002	0.00	13.57%	0.29%
20	14	0.002	0.002	0.00	17.79%	0.37%
30	15	0.002	0.002	0.00	14.38%	0.29%
30	16	0.002	0.002	0.00	11.56%	0.25%
30	17	0.002	0.002	0.00	17.61%	0.37%
30	18	0.002	0.002	0.00	12.31%	0.26%
30	19	0.002	0.002	0.00	16.05%	0.34%
30	20	0.002	0.002	0.00	12.49%	0.26%
31	15a	0.002	0.002	0.00	16.54%	0.34%
31	16a	0.002	0.002	0.00	11.47%	0.24%
31	17a	0.002	0.002	0.00	13.11%	0.28%
31	18a	0.002	0.002	0.00	14.37%	0.31%
31	19a	0.002	0.003	0.00	18.38%	0.39%
31	20a	0.002	0.002	0.00	12.72%	0.27%
50	21	0.002	0.003	0.00	23.84%	0.48%
50	22	0.002	0.002	0.00	16.90%	0.36%
50	23	0.002	0.003	0.00	16.66%	0.36%
50	24	0.002	0.002	0.00	17.15%	0.36%
50	25	0.002	0.003	0.00	13.44%	0.29%
	Max	0.002	0.003	0.00	23.84%	0.48%
	Average	0.002	0.002	0.00	15.17%	0.32%
	Min	0.002	0.002	0.00	7.02%	0.15%
	Std Dev	0.000	0.000	0.00	3.19%	0.06%

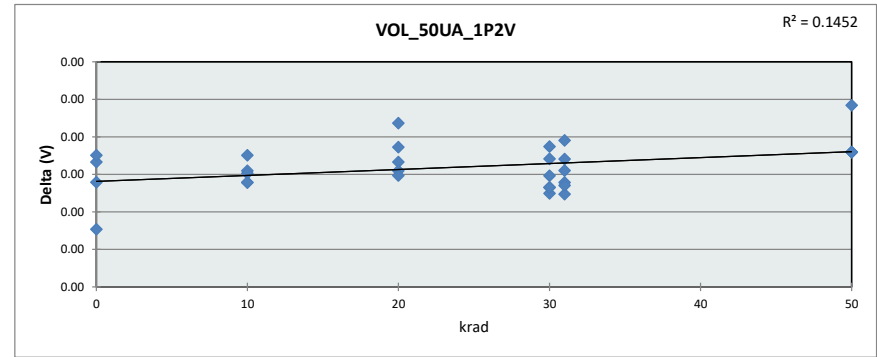

		VOL_50UA_1P2V					
Units		V					
Max Limit		0.1					
Min Limit		-0.001					
krad		0	10	20	30	31	50
LL		-0.001	-0.001	-0.001	-0.001	-0.001	-0.001
Min		0.002	0.002	0.002	0.002	0.002	0.002
Average		0.002	0.002	0.002	0.002	0.002	0.002
Max		0.002	0.002	0.002	0.002	0.003	0.003
UL		0.100	0.100	0.100	0.100	0.100	0.100

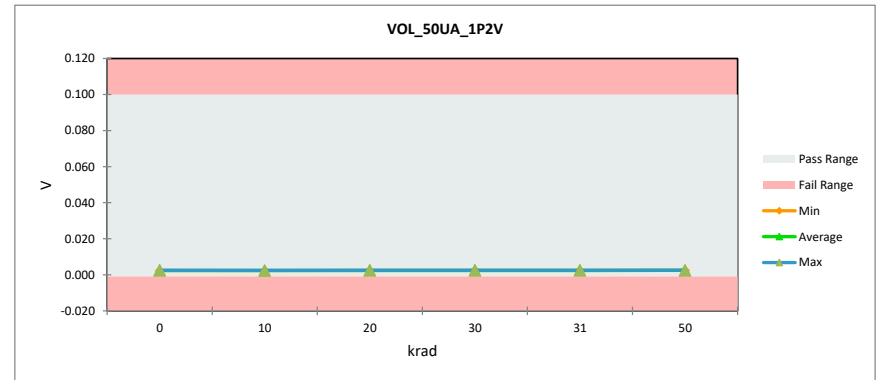

TID Report

SN54SC8T138-SEP

		VOL_50UA_5P5V				
		Units		V		
		Max Limit		0.1		
		Min Limit		-0.001		
krad	Serial #	PreTestHDR	PostTestHDR	Delta	Delta %	% of Limit Range
0	1	0.001	0.001	0.00	8.93%	0.06%
0	2	0.001	0.001	0.00	17.85%	0.10%
0	3	0.001	0.001	0.00	30.90%	0.16%
0	4	0.001	0.001	0.00	-0.66%	0.00%
10	5	0.001	0.001	0.00	16.05%	0.10%
10	6	0.001	0.001	0.00	8.93%	0.06%
10	7	0.001	0.001	0.00	15.13%	0.09%
10	8	0.001	0.001	0.00	12.89%	0.08%
10	9	0.001	0.001	0.00	22.79%	0.12%
20	10	0.001	0.001	0.00	-14.46%	0.09%
20	11	0.000	0.001	0.00	52.85%	0.26%
20	12	0.001	0.001	0.00	29.17%	0.16%
20	13	0.001	0.001	0.00	27.62%	0.16%
20	14	0.001	0.001	0.00	20.40%	0.12%
30	15	0.000	0.001	0.00	59.11%	0.29%
30	16	0.001	0.001	0.00	17.85%	0.10%
30	17	0.001	0.001	0.00	0.80%	0.00%
30	18	0.001	0.001	0.00	30.90%	0.16%
30	19	0.001	0.001	0.00	21.08%	0.12%
30	20	0.001	0.001	0.00	11.55%	0.07%
31	15a	0.000	0.001	0.00	46.58%	0.23%
31	16a	0.001	0.001	0.00	23.51%	0.13%
31	17a	0.001	0.001	0.00	5.88%	0.04%
31	18a	0.001	0.001	0.00	60.90%	0.31%
31	19a	0.001	0.001	0.00	34.83%	0.19%
31	20a	0.001	0.001	0.00	38.33%	0.22%
50	21	0.001	0.001	0.00	41.51%	0.24%
50	22	0.001	0.001	0.00	64.73%	0.39%
50	23	0.001	0.001	0.00	36.39%	0.22%
50	24	0.001	0.001	0.00	52.11%	0.30%
50	25	0.001	0.001	0.00	26.46%	0.18%
	Max	0.001	0.001	0.00	64.73%	0.39%
	Average	0.001	0.001	0.00	26.48%	0.15%
	Min	0.000	0.001	0.00	-14.46%	0.00%
	Std Dev	0.000	0.000	0.00	19.52%	0.10%

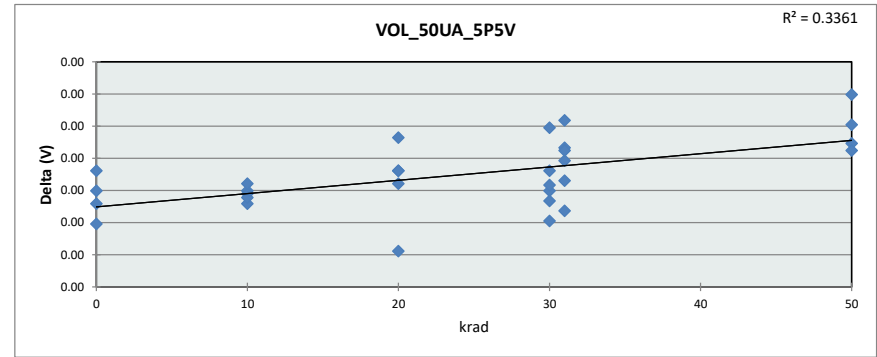

		VOL_50UA_5P5V				
		Units		V		
		Max Limit		0.1		
		Min Limit		-0.001		
krad		0	10	20	30	50
LL		-0.001	-0.001	-0.001	-0.001	-0.001
Min		0.001	0.001	0.001	0.001	0.001
Average		0.001	0.001	0.001	0.001	0.001
Max		0.001	0.001	0.001	0.001	0.001
UL		0.100	0.100	0.100	0.100	0.100

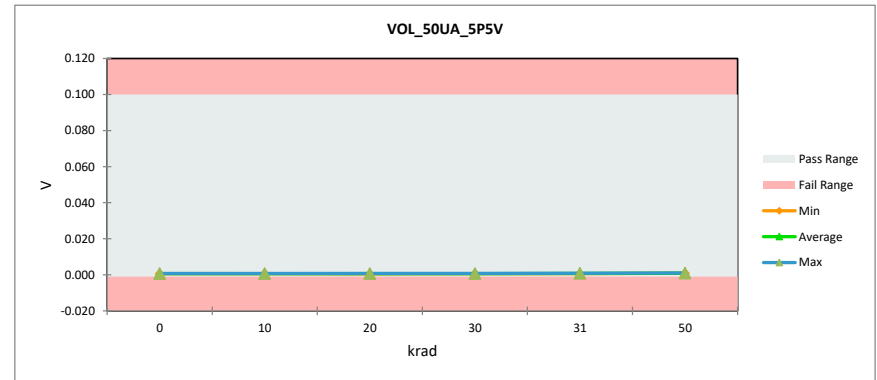

IMPORTANT NOTICE AND DISCLAIMER

TI PROVIDES TECHNICAL AND RELIABILITY DATA (INCLUDING DATA SHEETS), DESIGN RESOURCES (INCLUDING REFERENCE DESIGNS), APPLICATION OR OTHER DESIGN ADVICE, WEB TOOLS, SAFETY INFORMATION, AND OTHER RESOURCES "AS IS" AND WITH ALL FAULTS, AND DISCLAIMS ALL WARRANTIES, EXPRESS AND IMPLIED, INCLUDING WITHOUT LIMITATION ANY IMPLIED WARRANTIES OF MERCHANTABILITY, FITNESS FOR A PARTICULAR PURPOSE OR NON-INFRINGEMENT OF THIRD PARTY INTELLECTUAL PROPERTY RIGHTS.

These resources are intended for skilled developers designing with TI products. You are solely responsible for (1) selecting the appropriate TI products for your application, (2) designing, validating and testing your application, and (3) ensuring your application meets applicable standards, and any other safety, security, regulatory or other requirements.

These resources are subject to change without notice. TI grants you permission to use these resources only for development of an application that uses the TI products described in the resource. Other reproduction and display of these resources is prohibited. No license is granted to any other TI intellectual property right or to any third party intellectual property right. TI disclaims responsibility for, and you will fully indemnify TI and its representatives against, any claims, damages, costs, losses, and liabilities arising out of your use of these resources.

TI's products are provided subject to [TI's Terms of Sale](#) or other applicable terms available either on [ti.com](https://www.ti.com) or provided in conjunction with such TI products. TI's provision of these resources does not expand or otherwise alter TI's applicable warranties or warranty disclaimers for TI products.

TI objects to and rejects any additional or different terms you may have proposed.

Mailing Address: Texas Instruments, Post Office Box 655303, Dallas, Texas 75265

Copyright © 2025, Texas Instruments Incorporated