

TMS320F28054M, TMS320F28052M ***InstaSPIN-MOTION™ Software***

User's Guide



Literature Number: SPRUHW1A
JUNE 2014 – REVISED OCTOBER 2021

Read This First	5
About This Manual.....	5
Glossary.....	6
Support Resources.....	6
1 F2805xM InstaSPIN-MOTION™ Enabled MCUs	7
2 InstaSPIN-MOTION Key Capabilities and Benefits	9
2.1 Overview.....	10
2.2 FAST Unified Observer.....	10
2.3 SpinTAC Motion Control Suite.....	11
IDENTIFY.....	11
CONTROL.....	11
MOVE.....	12
PLAN.....	13
2.4 Additional InstaSPIN-MOTION Features.....	14
3 InstaSPIN-MOTION Block Diagrams	15
Scenario 1: InstaSPIN-MOTION Speed Control with FAST Software Encoder.....	16
Scenario 2: InstaSPIN-MOTION Speed Control with a Mechanical Sensor.....	18
Scenario 3: InstaSPIN-MOTION Position Control with Mechanical Sensor and Redundant FAST Software Sensor.....	19
4 Application Examples	21
4.1 Treadmill Conveyor: Smooth Motion Across Varying Speeds and Loads.....	22
4.2 Video Camera: Smooth Motion and Position Accuracy at Low Speeds.....	22
4.3 Washing Machine: Smooth Motion and Position Accuracy at Low Speeds.....	22
Agitation Cycle.....	24
Spin Cycles.....	25
4.4 InstaSPIN-MOTION Works Over the Entire Operating Range.....	26
5 Evaluating InstaSPIN-MOTION Performance	27
5.1 Overview.....	28
5.2 Velocity Control Performance: SpinTAC vs PI.....	30
5.2.1 Disturbance Rejection.....	30
5.2.2 Reference Tracking.....	34
5.2.3 Step Response.....	39
5.3 Position Control Performance: SpinTAC vs PI.....	41
5.3.1 Disturbance Rejection.....	42
5.3.2 Reference Tracking.....	45
5.3.3 Step Response.....	47
5.3.4 Inertia Estimation Repeatability.....	50
6 Microcontroller Resources	53
6.1 CPU Utilization.....	54
6.2 Memory Utilization.....	57
6.3 Security Zones.....	59
6.4 Linker Command File Settings.....	59
6.5 Interfacing FAST ROM Libraries.....	59
6.6 Pin Utilization.....	60
6.7 Consideration of Analog Front-End (AFE) Module.....	60
6.7.1 Routing Current Signals.....	61
6.7.2 Voltage Reference Connection.....	62
6.7.3 Routing Voltage Signals.....	63
A Resources	65
B Definition of Terms and Acronyms	67
Revision History	69

List of Figures

Figure 1-1. InstaSPIN-MOTION = C2000 F2805xM MCU + FAST Software Sensor (optional) + Auto-Tuned Inner-Torque Controller + SpinTAC Motion Control Suite.....	7
Figure 2-1. SpinTAC Motion Control Suite Components.....	10
Figure 2-2. Simple Tuning Interface.....	12
Figure 2-3. SpinTAC™ Move Curve Descriptions.....	12
Figure 2-4. State Transition Map for a Washing Machine.....	13
Figure 2-5. State Transition Map for a Garage Door System.....	14
Figure 3-1. InstaSPIN-MOTION in User Memory, with Exception of FAST and SpinTAC in ROM.....	16
Figure 3-2. InstaSPIN-MOTION in ROM.....	17
Figure 3-3. InstaSPIN-MOTION Speed Control with a Mechanical Sensor.....	18
Figure 3-4. InstaSPIN-MOTION Position Control with Mechanical Sensor and Redundant FAST Software Sensor.....	19
Figure 4-1. Washing Machine Profile.....	23
Figure 4-2. InstaSPIN-MOTION Minimizes Error.....	24
Figure 4-3. First Spin Cycle - 500 rpm.....	25
Figure 4-4. Second Spin Cycle - 2000 rpm.....	26
Figure 5-1. Applied Torque Disturbance Comparison.....	29
Figure 5-2. Removed Torque Disturbance Comparison.....	29
Figure 5-3. Disturbance Rejection Test of Maximum Speed Error and Settling Time.....	31
Figure 5-4. Disturbance Rejection Test with Controller Saturation.....	32
Figure 5-5. Speed Profile Used During Reference Tracking Test.....	35
Figure 5-6. Large Overshoot for PI Controller During Reference Tracking.....	36
Figure 5-7. Speed Tracking Error for PI Controller During Reference Tracking.....	37
Figure 5-8. Startup Error From Zero Start for PI Controller.....	38
Figure 5-9. Step Response Test of Maximum Overshoot and Settling Time.....	39
Figure 5-10. Disturbance Rejection Test of Maximum Position Error and Settling Time.....	42
Figure 5-11. Position Profile Used During Reference Tracking Test.....	45
Figure 5-12. PI Error During Position Tracking.....	46
Figure 5-13. Step Response Test of Maximum Overshoot and Settling Time.....	48
Figure 5-14. Inertia Estimation Results for Teknic M-2310P.....	50
Figure 5-15. Inertia Estimation Results for Estun EMJ-04APB22.....	51
Figure 6-1. Software Execution Clock Tree Provides Flexibility with Real-Time Scheduling.....	54
Figure 6-2. F2805xF and F2805xM Allocated Memory for InstaSPIN-FOC and SpinTAC Library.....	58
Figure 6-3. 2805x Project with ROM Symbols Library.....	59
Figure 6-4. Current Signal Routing Directly to PGAs With Single-Ended Connections.....	61
Figure 6-5. Feedback of Phase Currents Using External Differential Amplifiers.....	62
Figure 6-6. Using the AFE's Built-In Voltage Reference For Measuring a Bipolar Signal.....	63

List of Tables

Table 1-1. C2000 InstaSPIN Device Guide.....	5
Table 1-1. InstaSPIN-MOTION Application Examples.....	8
Table 5-1. PI vs InstaSPIN-MOTION.....	28
Table 5-2. SpinTAC vs PI Disturbance Rejection Test Results (Teknic Motor).....	33
Table 5-3. SpinTAC vs PI Disturbance Rejection Test Results (Estun Motor).....	34
Table 5-4. SpinTAC vs PI Profile Tracking Test Results.....	38
Table 5-5. SpinTAC vs PI Step Response Test Results (Teknic Motor).....	40
Table 5-6. SpinTAC vs PI Step Response Test Results (Estun Motor).....	40
Table 5-7. SpinTAC vs PI Position Control Disturbance Rejection Test Results (Teknic Motor).....	43
Table 5-8. SpinTAC vs PI Position Control Disturbance Rejection Test Results (Estun Motor).....	44
Table 5-9. SpinTAC vs PI Position Profile Tracking Test Results.....	47
Table 5-10. SpinTAC vs PI Position Control Step Response Test Results (Teknic Motor).....	48
Table 5-11. SpinTAC vs PI Position Control Step Response Test Results (Estun Motor).....	49
Table 6-1. SpinTAC CPU Cycle Utilization with Library Executing in Flash.....	55
Table 6-2. Code Size and RAM Usage for SpinTAC Components.....	57
Table 6-3. Stack Utilization of SpinTAC Components + InstaSPIN-FOC.....	57
Table 6-4. 2805xF and 2805xM Allocated Memory for InstaSPIN-FOC and SpinTAC Library.....	58
Table 6-5. Pin Utilization Per Motor.....	60

About This Manual

Table 1-1. C2000 InstaSPIN Device Guide

Device Families	InstaSPIN Library Version	Solution Support	Software Package	User's Guide
TMS320F2805xM	V1p7	InstaSPIN-MOTION	MotorWare	This Guide

Welcome and thank you for selecting Texas Instrument's InstaSPIN™ solutions. This document will guide you through the technical details of InstaSPIN software enabling you to integrate this solution into your application. The structure of this document can be summarized as:

- Introduction to
 - InstaSPIN-MOTION™ and SpinTAC™
- Running a motor immediately with TI hardware and software
- Understand software details, from reviewing API function calls to state diagrams and tuning the speed and position control loops
- Understanding hardware aspects that directly impact InstaSPIN's performance.

All of the above are provided to help you develop a successful product using InstaSPIN-FOC or InstaSPIN-MOTION software. Example projects (labs) are a key part of this success and are designed to relate specifically with the topics in this document. They are intended for you to not only experiment with InstaSPIN but to also use as reference for your design. The most up-to-date InstaSPIN-FOC and InstaSPIN-MOTION solutions and design resources, along with practical videos, can be found at: [TI InstaSPIN™ motor control solutions](#).

Definition of terms that are used throughout this document can be found in [Appendix B](#). The most common terms used are the following:

- FOC:
 - Field-Oriented Control
- InstaSPIN-FOC:
 - Complete sensorless FOC solution provided by TI on-chip in ROM on select devices (FAST observer, FOC, speed and current loops), efficiently controlling your motor without the use of any mechanical rotor sensors.
- FAST
 - Unified observer structure which exploits the similarities between all motors that use magnetic flux for energy transduction, automatically identifying required motor parameters and providing motor feedback signals: **F**lux, flux **A**ngle, motor shaft **S**peed, and **T**orque.

- SpinTAC Motion Control Suite:
 - Includes an advanced speed and position controller, a motion engine, and a motion sequence planner. The SpinTAC disturbance-rejecting speed controller proactively estimates and compensates for system disturbances in real-time, improving overall product performance. The SpinTAC motion engine calculates the ideal reference signal (with feed forward) based on user-defined parameters. SpinTAC supports the standard industry curves, and LineStream's proprietary “smooth trajectory” curve. The SpinTAC motion sequence planner operates user-defined state transition maps, making it easy to design complex motion sequences.
- InstaSPIN-MOTION:
 - A comprehensive sensorless or sensed FOC solution for motor-, motion-, speed-, and position-control. This solution delivers robust system performance at the highest efficiency for motor applications that operate in various motion state transitions. InstaSPIN-MOTION includes the FAST unified software observer, combined with SpinTAC Motion Control Suite from [LineStream Technologies](#).
- MotorWare™ software:
 - TI supplied scalable software architecture for motor control, of which InstaSPIN-FOC is a part.

Whether you are using TI supplied inverters and motors or using your own, this document helps you learn about this new and empowering solution from TI.

Glossary

[TI Glossary](#) This glossary lists and explains terms, acronyms, and definitions.

Support Resources

[TI E2E™ support forums](#) are an engineer's go-to source for fast, verified answers and design help — straight from the experts. Search existing answers or ask your own question to get the quick design help you need.

Linked content is provided "AS IS" by the respective contributors. They do not constitute TI specifications and do not necessarily reflect TI's views; see TI's [Terms of Use](#).

Trademarks

InstaSPIN-MOTION™, InstaSPIN™, MotorWare™, TI E2E™, C2000™, FAST™, PowerWarp™, Code Composer Studio™, and E2E™ are trademarks of Texas Instruments. SpinTAC™ are trademarks of LineStream Technologies. All trademarks are the property of their respective owners.

InstaSPIN-MOTION is no longer recommended for new designs and will not have application support. For motion control solutions please see the latest examples released in [MotorControl software development kit \(SDK\) for C2000™ MCUs](#).

InstaSPIN-MOTION [TMS320F2805xM (54M and 52M — 80-pin package)] is the first offering from Texas Instruments to combine TI 32-bit C2000™ microcontrollers with comprehensive motor-, motion-, speed-, and position-control software. InstaSPIN-MOTION delivers robust velocity and position control at the highest efficiency for motor applications that operate in various motion state transitions. InstaSPIN-MOTION is your own motion control expert, on a single chip.

InstaSPIN-MOTION is a sensorless or sensed field-oriented motor control (FOC) solution that can identify, tune, and control your motor in minutes. InstaSPIN-MOTION features the FAST™ premium software sensor and the SpinTAC™ Motion Control Suite (Figure 1-1). The core algorithms are embedded in the read-only-memory (ROM) on TI 32-bit C2000 microcontrollers (MCUs).

InstaSPIN™ -MOTION

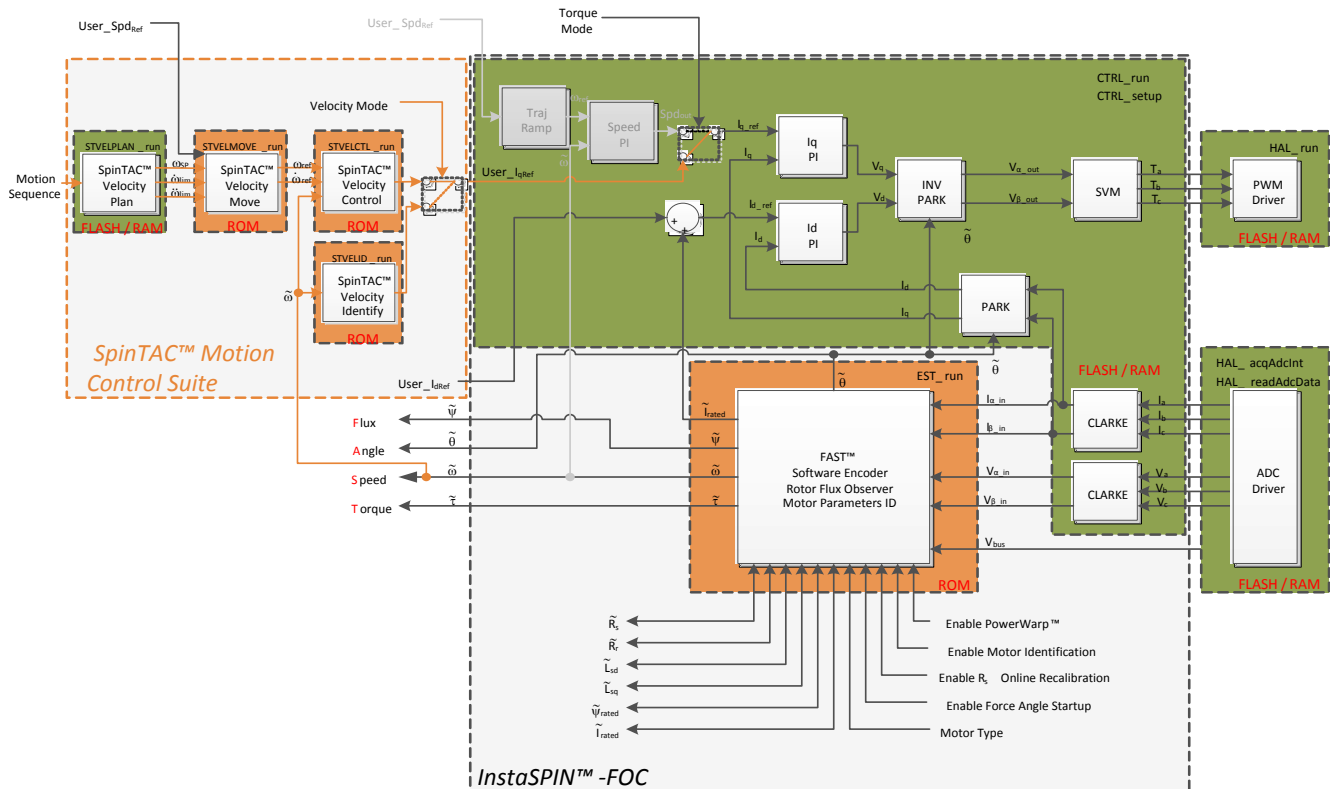

Figure 1-1. InstaSPIN-MOTION = C2000 F2805xM MCU + FAST Software Sensor (optional) + Auto-Tuned Inner-Torque Controller + SpinTAC Motion Control Suite

InstaSPIN-MOTION is ideal for applications that require accurate speed and position control, minimal disturbance, or undergo multiple state transitions or experience dynamic speed or load changes.

Table 1-1 provides examples of applications that will most benefit from InstaSPIN-MOTION.

Table 1-1. InstaSPIN-MOTION Application Examples

Application Characteristics	Examples
Accurate speed control	Industrial fans Conveyor systems Elevators/escalators Automotive body parts (electric windows, sunroofs) Optical disc drives/hard drives Medical mixing
Accurate position control	Surveillance systems Packaging systems Medical robots Gimbal systems Textile/Sewing machines
Minimal disturbance	Dental tools Power tools Security gates and doors
Undergoes multiple state transitions/ dynamic changes	HVAC pumps, fans and blowers Generators Air conditioning compressors Washing machines Exercise equipment Medical pumps

This document focuses on the additive features provided in InstaSPIN-MOTION and is a supplement to all standard TMS320F2805xM documentation, including:

SPRS797 *TMS320F28055, TMS320F28054, TMS320F28053 TMS320F28052, TMS320F28051, TMS320F28050 Microcontrollers Data Manual*. Contains the pinout, signal descriptions, as well as electrical and timing specifications for the 2805x devices.

SPRUHE5 *TMS320x2805x Technical Reference Manual*. Details the integration, the environment, the functional description, and the programming models for each peripheral and subsystem in the device.

SPRU566 *C2000 Real-Time Control MCU Peripherals Reference Guide*. Describes the peripheral reference guides of the C28x digital signal processors (DSPs).

Additionally, the InstaSPIN-MOTION documentation package includes:

SPRUHJ1 *TMS320F2802xF, TMS320F2805xF, TMS320F2806xF InstaSPIN-FOC, TMS320F2805xM, TMS320F2806xM InstaSPIN-MOTION User's Guide*. Covers the scope and functionality of:

- F2805xM devices
- F2805xM ROM contents
- InstaSPIN-MOTION system solutions.



InstaSPIN-MOTION Key Capabilities and Benefits

2.1 Overview.....	10
2.2 FAST Unified Observer.....	10
2.3 SpinTAC Motion Control Suite.....	11
2.4 Additional InstaSPIN-MOTION Features.....	14

2.1 Overview

InstaSPIN-MOTION replaces inefficient, older design techniques with a solution that maximizes system performance and minimizes design effort. By embedding the motor expertise on the chip, InstaSPIN-MOTION enables users to focus on optimizing their application rather than struggling with motion control.

InstaSPIN-MOTION provides the following core capabilities:

- The FAST unified observer, which exploits the similarities between all motors that use magnetic flux for energy transduction. The FAST estimator measures rotor flux (magnitude, angle, and speed) as well as shaft torque in a sensorless FOC system.
- Motor parameter identification, used to tune the FAST observer and initialize the innermost current (torque) PI controllers for I_q and I_d control of the FOC system.
- SpinTAC, a comprehensive motion control suite (see [Figure 2-1](#)) from LineStream Technologies, simplifies tuning and ensures optimal performance across dynamic speed and position ranges.

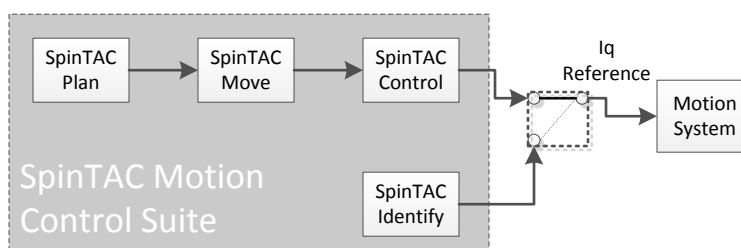

Figure 2-1. SpinTAC Motion Control Suite Components

2.2 FAST Unified Observer

FAST unified observer structure exploits the similarities between all motors that use magnetic flux for energy transduction:

- Supports both synchronous (BLDC, SPM, IPM) and asynchronous (ACIM) control.
- Provides salient compensation for interior permanent magnet motors. Observer tracks rotor flux and angle correctly when L_s-d and L_s-q are provided.

FAST offers unique, high-quality motor feedback signals for control systems:

- High-quality **F**lux signal for stable flux monitoring and field weakening.
- Superior rotor flux **A**ngle estimation accuracy over wider speed range compared to traditional observer techniques independent of all rotor parameters for ACIM.
- Real-time low-noise motor shaft **S**peed signal.
- Accurate high-bandwidth **T**orque signal for load monitoring and imbalance detection.

FAST replaces mechanical encoders and resolvers, and accelerates control system design:

- Angle estimator converges within first cycle of the applied waveform, regardless of speed.
- Stable operation in all power quadrants, including generator quadrants.
- Accurate angle estimation at steady state speeds below 1 Hz (typical) with full torque.
- Angle integrity maintained even during slow speed reversals through zero speed.
- Angle integrity maintained during stall conditions, enabling smooth stall recovery.
- Motor Identification measures required electrical motor parameters of unloaded motor in under 2 minutes (typical).
- "On-the-fly" stator resistance recalibration (online R_s) tracks stator resistance changes in real time, resulting in robust operation over temperature. This feature can also be used as a temperature sensor of the motor's windings (basepoint calibration required).
- Superior transient response of rotor flux angle tracking compared to traditional observers.
- PowerWarp™ adaptively reduces current consumption to minimize the combined (rotor and stator) copper losses to the lowest, without compromising ACIM output power levels.

2.3 SpinTAC Motion Control Suite

SpinTAC minimizes the time you spend defining how you want your motor to spin and ensures that your motor runs at its optimal level for ideal performance. Key benefits include:

- **Simplified Tuning** - Tune your system for the entire position and speed operating range with a single parameter.
- **Intuitive Trajectory Planning** - Easily design and execute complex motion sequences.
- **Mechanically Sound Movement** - Optimize your transitions between speeds based on your system's mechanical limitations.
- **Ideal Control** - Benefit from the most accurate speed and position control on the market, based on LineStream's patented Active Disturbance Rejection Control.

There are four components that comprise the SpinTAC Motion Control Suite:

- Identify
- Control
- Move
- Plan

Each of these components exists for both the Velocity and Position solution.

IDENTIFY

SpinTAC Identify estimates inertia (the resistance of an object to rotational acceleration around an axis). The greater the system inertia, the greater the torque needed to accelerate or decelerate the motor. The SpinTAC speed controller uses the system's inertia value to provide the most accurate system control. SpinTAC Identify automatically measures system inertia by spinning the motor in the application and measuring the feedback.

CONTROL

SpinTAC Control is an advanced speed and position controller featuring Active Disturbance Rejection Control (ADRC), which proactively estimates and compensates for system disturbance, in real-time. SpinTAC automatically compensates for undesired system behavior caused by:

- Uncertainties (for example, resonant mode)
- Nonlinear friction
- Changing loads
- Environmental changes.

SpinTAC Control presents better disturbance rejection and trajectory tracking performance than a PI controller, and can tolerate a wide range of inertia change. This means that SpinTAC improves accuracy and system performance, and minimizes mechanical system duress.

With single coefficient tuning, the SpinTAC controller allows users to quickly test and tune their velocity and position control from soft to stiff response. This single gain (bandwidth) typically works across the entire variable speed, position and load range of an application, reducing complexity and system tuning time typical in multi-variable PI-based systems. A single parameter controls both position and speed. These systems often require a dozen or more tuned coefficient sets to handle all possible dynamic conditions.

The InstaSPIN-MOTION (F2805xM) graphical user interface (GUI) (see [Figure 2-2](#)), in conjunction with the InstaSPIN-MOTION Quick Start Guide, allows users to quickly evaluate InstaSPIN-MOTION (speed control) using TI's evaluation kits and the TI provided motors, or their own motor. The GUI is designed to quickly guide you through the InstaSPIN-MOTION evaluation process. You can obtain the GUI, free of charge, from [Motor Kit Application Software for TMDSCNCD28069MISO control/CARDs](#). Once you determine that InstaSPIN-MOTION is right for your application, use the MotorWare™-based projects, in conjunction with the [InstaSPIN-FOC and InstaSPIN-MOTION User's Guide](#) to design your project and conduct performance testing.

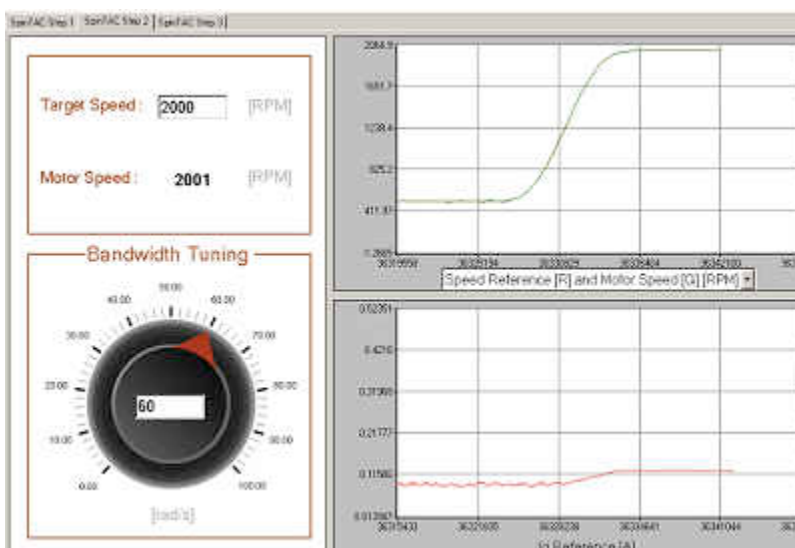

Figure 2-2. Simple Tuning Interface

MOVE

SpinTAC Move provides an easy way to smoothly transition from one speed or position to another by computing the fastest path between Point A and Point B. SpinTAC Move generates a profile based on starting velocity or position, desired velocity or position, and configured system limitations for acceleration and jerk. Jerk represents the rate of change of acceleration. A larger jerk will increase the acceleration at a faster rate. Steps, or sharp movement between two points, can cause systems to oscillate. The bigger the step, the greater this tendency. Control over jerk can round the velocity corners, reducing oscillation. As a result, acceleration can be set higher. Controlling the jerk in your system will lead to less mechanical stress on your system components and can lead to better reliability and less failing parts.

As opposed to pre-defined lookup tables, SpinTAC Move runs on the processor, consuming less memory than traditional solutions. Besides the industry standard trapezoidal curve and s-Curve, SpinTAC also provides a proprietary st-Curve, which is even smoother than s-Curve and allows users to limit the jerk of the motion.

Figure 2-3 describes the curves that are available for use in SpinTAC Move. The LineStream proprietary st-Curve provides the smoothest motion by smoothing out the acceleration of the profile. For most applications the st-Curve represents the best motion profile.











Signals	Trapezoidal	s-Curve	st-Curve
Position	 Smooth	 Smooth	 Smooth
Velocity	 Continuous	 Smooth	 Smooth
Acceleration	 Bounded	 Continuous	 Smooth
Jerk	 Infinite	 Bounded	 Continuous

Figure 2-3. SpinTAC™ Move Curve Descriptions

PLAN

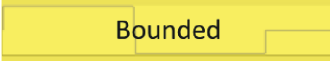
SpinTAC Plan provides easy design and execution of complex motion sequences. The trajectory planning feature allows users to quickly build various states of motion (speed or position A to speed or position B) and tie them together with state-based logic. SpinTAC Plan can be used to implement a motion sequence for nearly any application. Figure 2-4 displays the motion sequence for a washing machine and Figure 2-5 displays the motion sequence for a garage door. Both of these were easily designed using SpinTAC Plan. Once designed, the trajectories are directly embedded into the C code on the microcontroller.

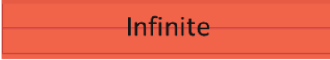
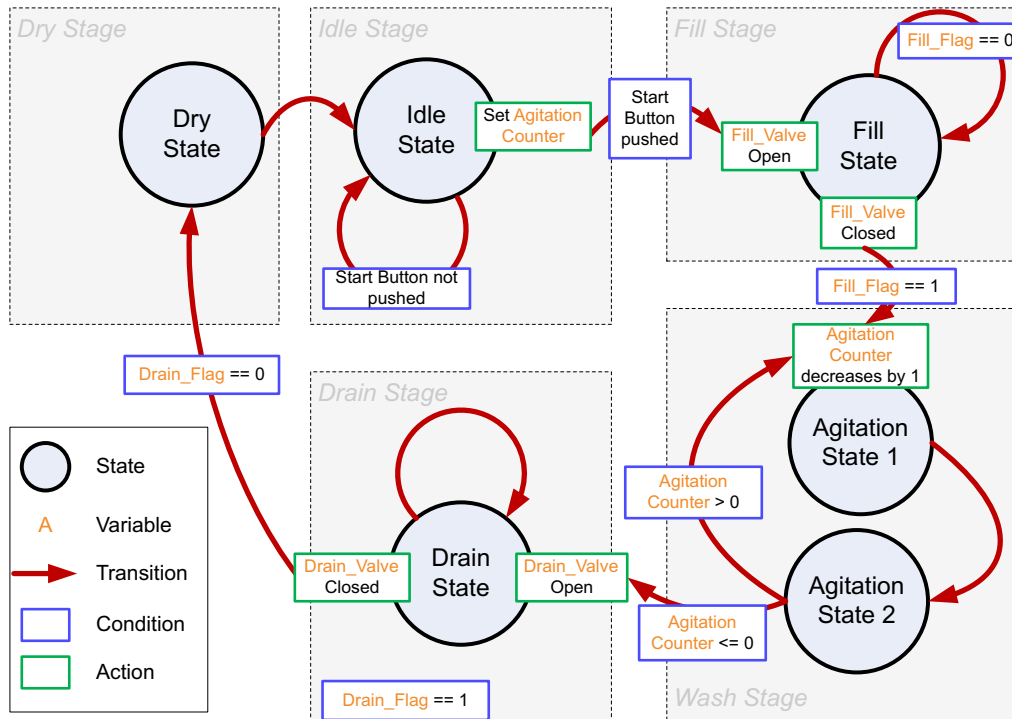

Figure 2-4. State Transition Map for a Washing Machine

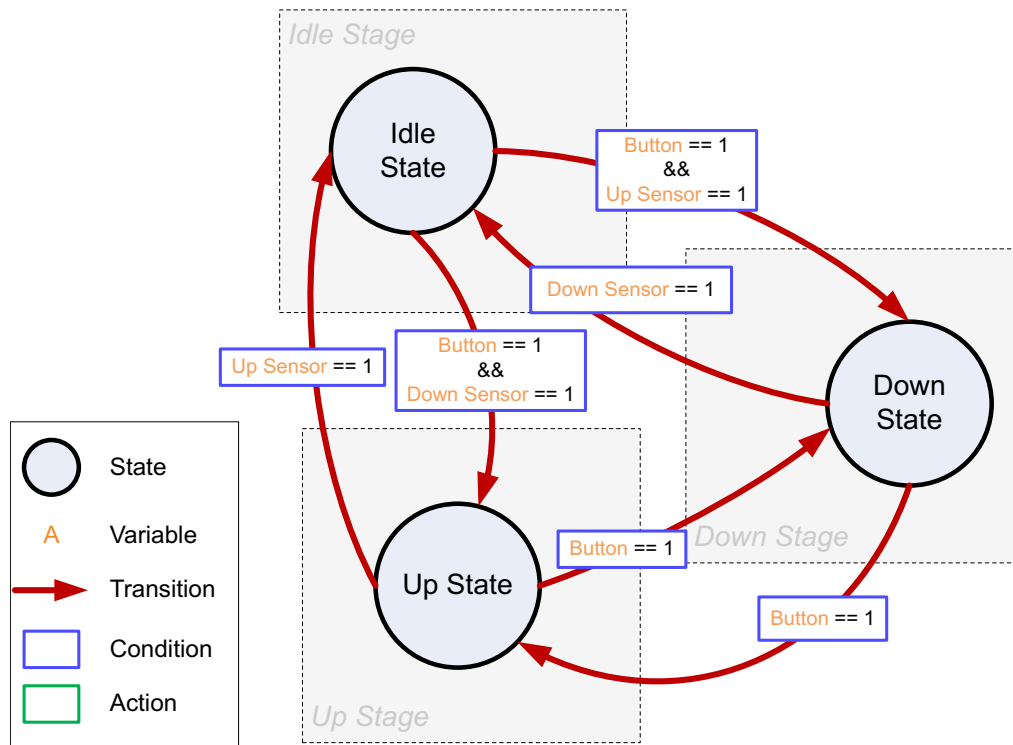

Figure 2-5. State Transition Map for a Garage Door System

2.4 Additional InstaSPIN-MOTION Features

- Automatic torque (current) loop tuning with option for user adjustments.
- Automatic or manual field weakening and field boosting.
- Bus voltage compensation.
- Automatic offset calibration ensures quality samples of feedback signals.

InstaSPIN-MOTION is designed in a modular structure. Customers can determine which functions will be included in their system. The FAST Observer resides in ROM. The core control algorithms of the SpinTAC library reside in ROM, and these functions are accessed by Application Program Interface (API) from the user code.

InstaSPIN-MOTION supports a wide array of system designs. InstaSPIN-MOTION uses the FAST software encoder for sensorless FOC systems (for additional information, see the [TMS320F28052F](#), [TMS320F28054F](#) *InstaSPIN-FOC™ Software Technical Reference Manual*). InstaSPIN-MOTION also supports solutions that leverage mechanical sensors (for example, encoders and resolvers). These scenarios are described below.

The variables in [Figure 3-1](#), [Figure 3-2](#), [Figure 3-3](#), and [Figure 3-4](#) are defined as:

- θ_{Qep} : position angle signal from encoder
- θ_{SP} : sawtooth position reference signal generated by SpinTAC Position Move
- ω_{lim} : speed limit (used in position profile generation)
- $\dot{\omega}_{lim}$: acceleration limit
- $\ddot{\omega}_{lim}$: jerk limit
- ω_{Ref} : speed reference
- $\dot{\omega}_{Ref}$: acceleration reference
- $\tilde{\tau}_r$: motor time constant

Scenario 1: InstaSPIN-MOTION Speed Control with FAST Software Encoder

In this scenario (see Figure 3-1 and Figure 3-2), SpinTAC Velocity Control receives the speed estimate from the FAST estimator and generates the torque reference signal. This works with InstaSPIN-FOC in user memory (see Figure 3-1) or in ROM (see Figure 3-2). The SpinTAC Motion Control Suite provides the motion sequence state machine, generates the reference trajectory and controls the system speed.

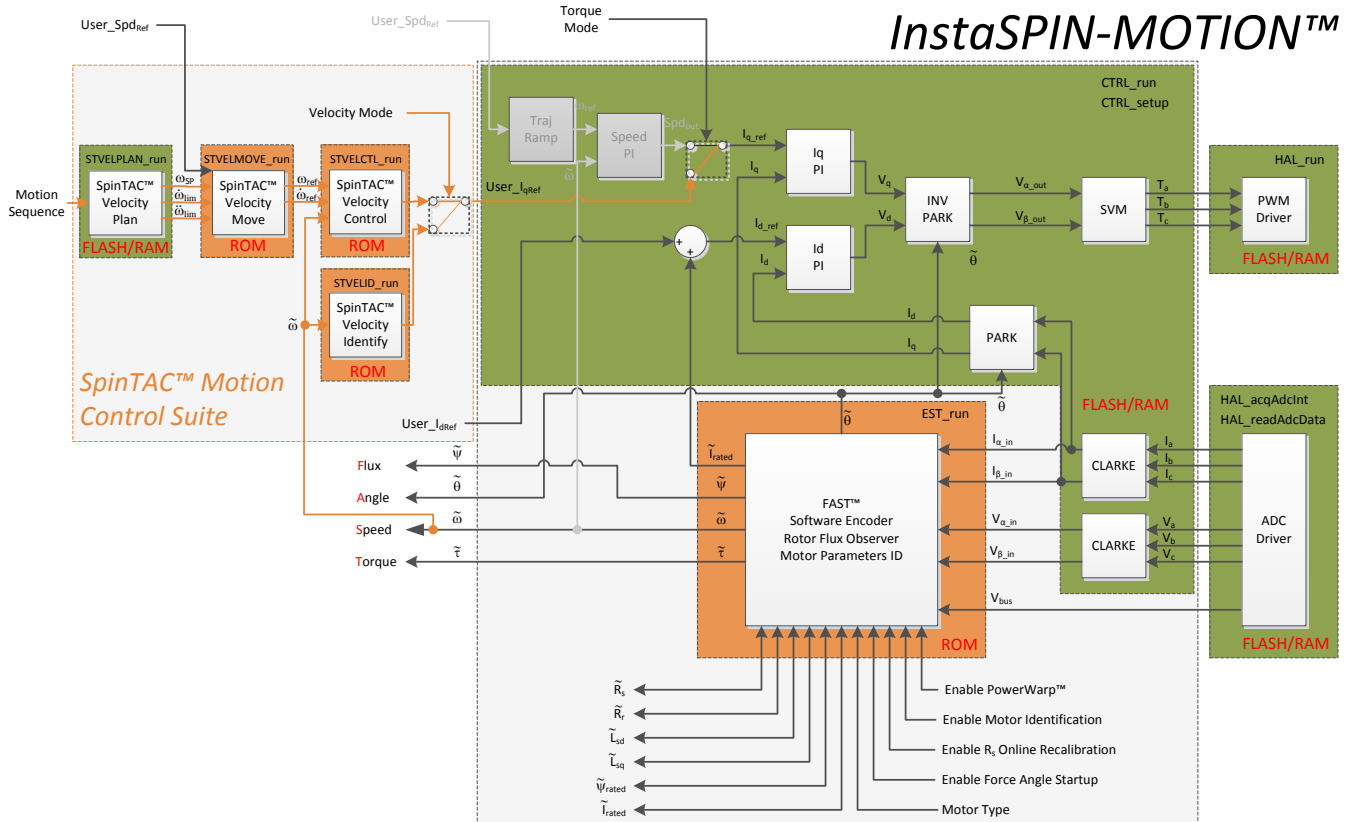

Figure 3-1. InstaSPIN-MOTION in User Memory, with Exception of FAST and SpinTAC in ROM

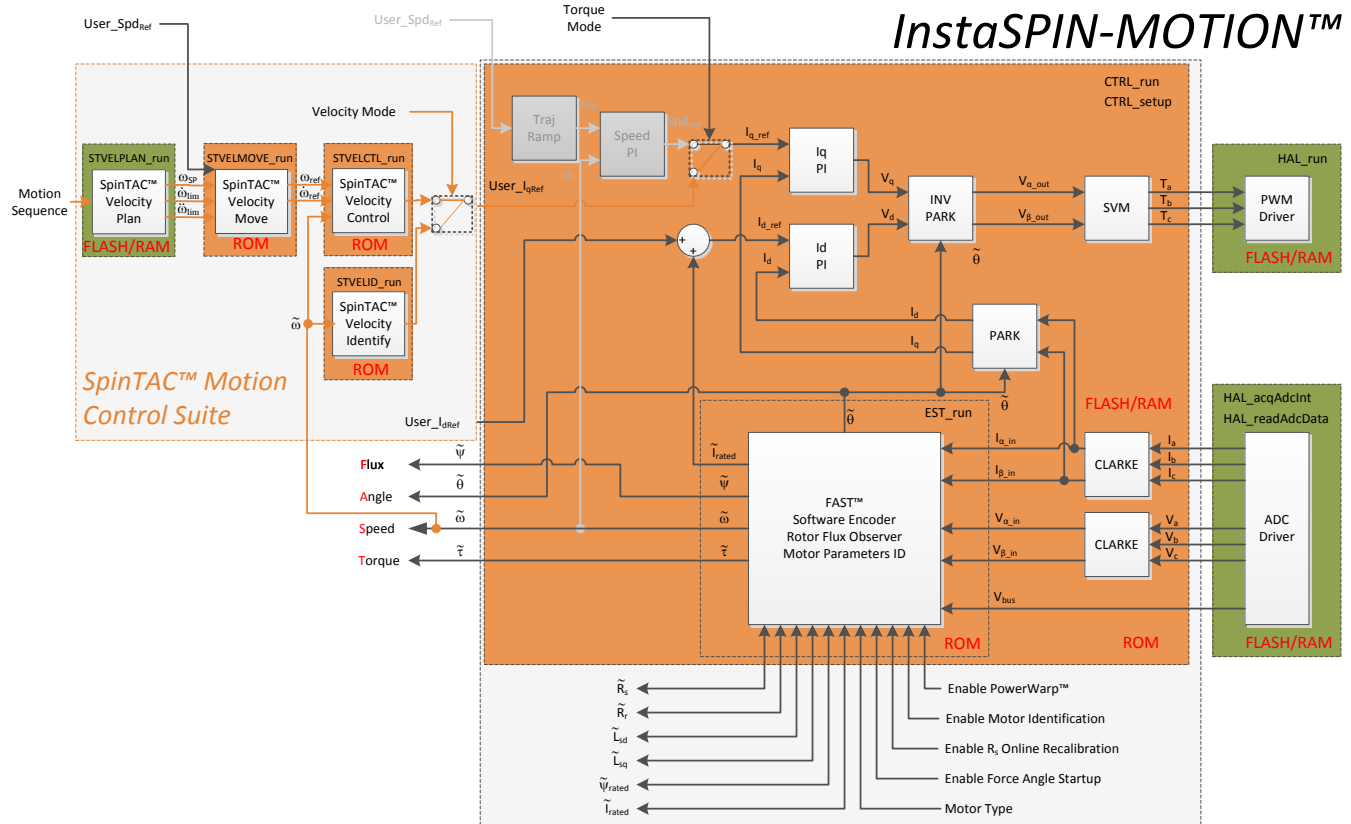

Figure 3-2. InstaSPIN-MOTION in ROM

Scenario 2: InstaSPIN-MOTION Speed Control with a Mechanical Sensor

While sensorless solutions are appealing and cost effective for many applications, there are some applications that require the rigor and accuracy of a mechanical sensor. For these applications (see Figure 3-3), the quadrature encoder provides position information, which is then converted to speed feedback via the SpinTAC Position Convert. SpinTAC Velocity Control receives the speed feedback and generates the torque reference signal via IqRef. The SpinTAC Motion Control Suite provides the motion sequence state machine, generates the reference trajectory, and controls the system speed.

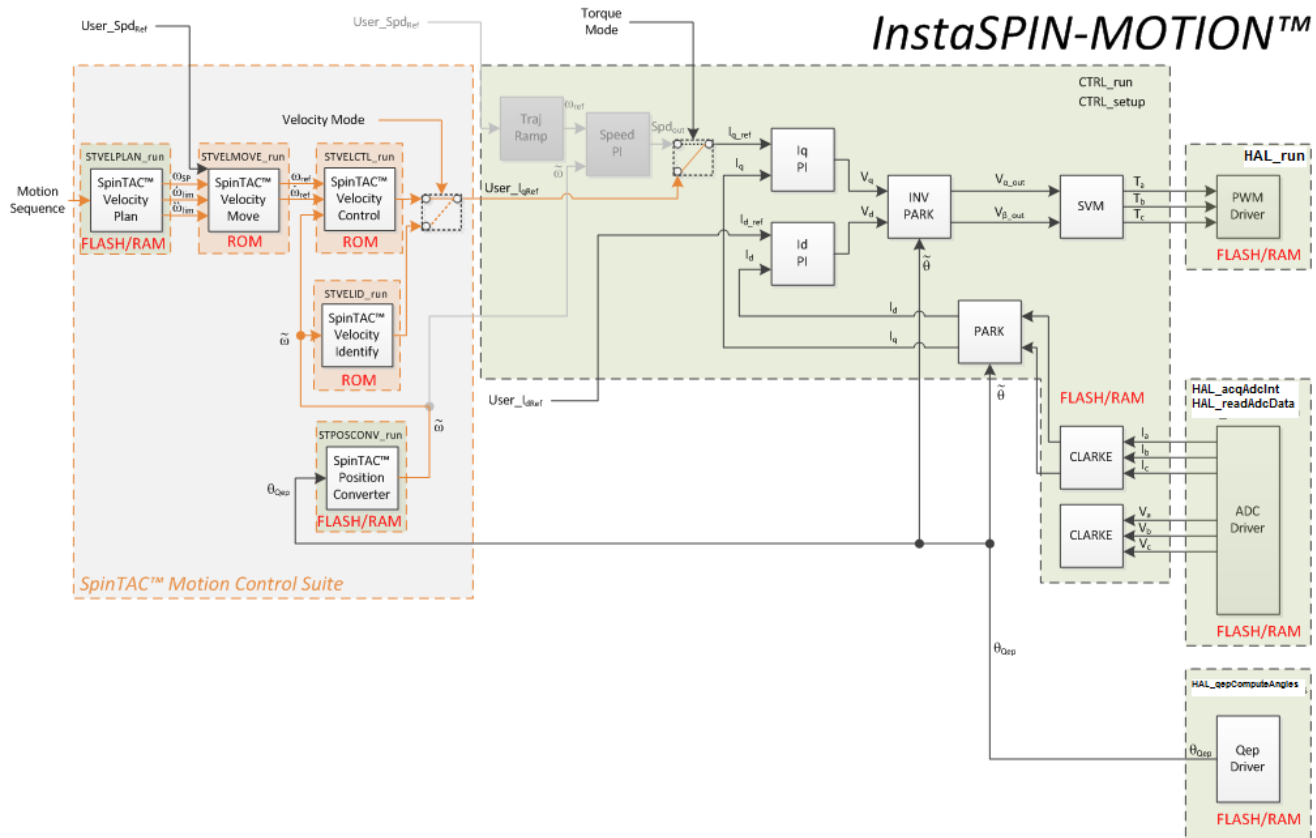

Figure 3-3. InstaSPIN-MOTION Speed Control with a Mechanical Sensor

Scenario 3: InstaSPIN-MOTION Position Control with Mechanical Sensor and Redundant FAST Software Sensor

There are many applications where precise position control is required. For these applications, it is difficult to balance the many tuning parameters that are required. InstaSPIN-MOTION features accurate position, speed, and torque control with combined position and speed single-variable tuning (see Figure 3-4). This simplifies the tuning challenge and allows you to focus on your application and not on tuning your motor. Position applications require a mechanical sensor in order to precisely identify the motor angle at zero and very low speeds. The FAST Software Encoder may provide redundancy in position control applications; this can be used as a safety feature in case the mechanical encoder fails.

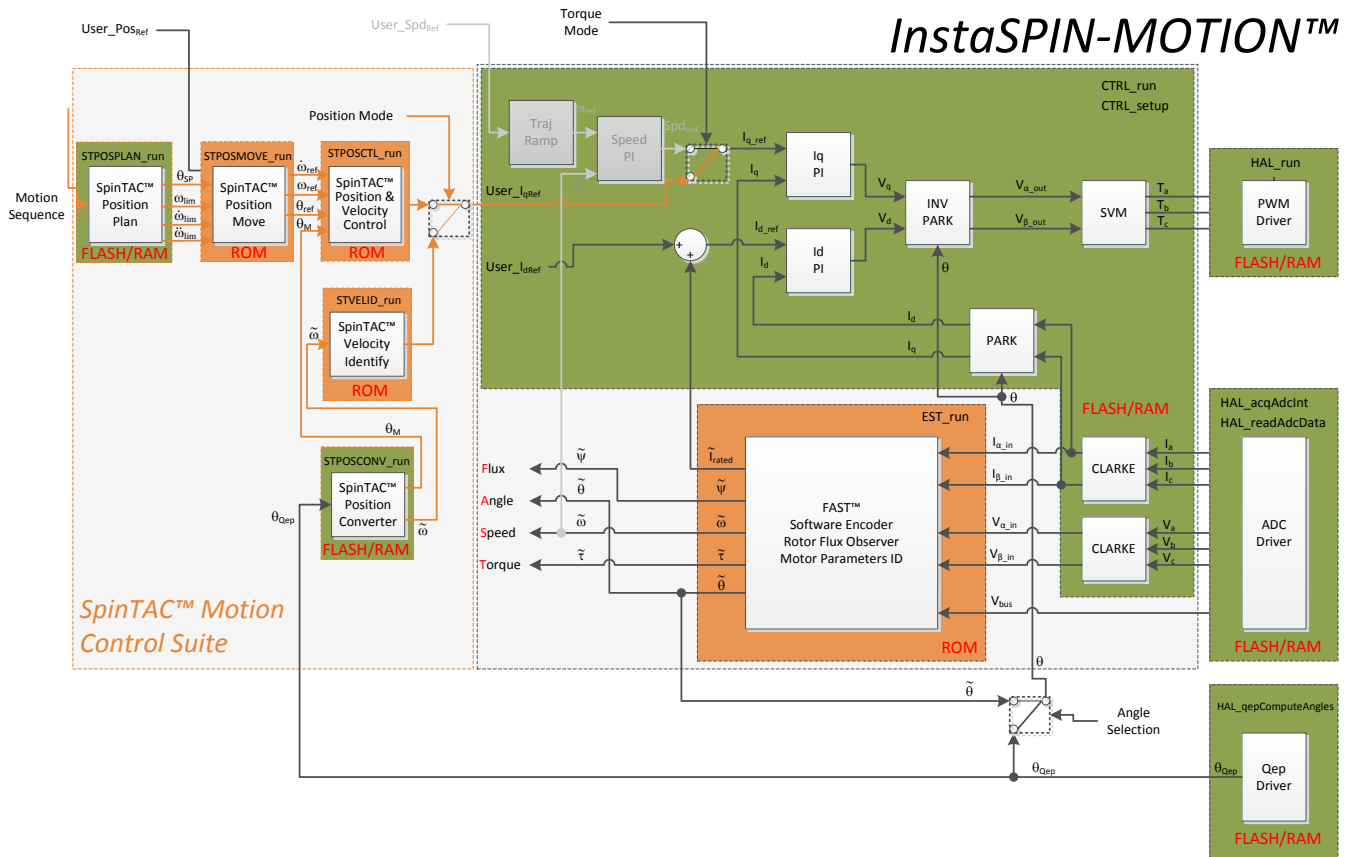

Figure 3-4. InstaSPIN-MOTION Position Control with Mechanical Sensor and Redundant FAST Software Sensor

This page intentionally left blank.

InstaSPIN-MOTION is ideal for applications that require accurate speed and position control, minimal disturbance, and for applications that undergo multiple state transitions or experience dynamic changes. A few examples are provided in the following sections.

4.1 Treadmill Conveyor: Smooth Motion Across Varying Speeds and Loads.....	22
4.2 Video Camera: Smooth Motion and Position Accuracy at Low Speeds.....	22
4.3 Washing Machine: Smooth Motion and Position Accuracy at Low Speeds.....	22
4.4 InstaSPIN-MOTION Works Over the Entire Operating Range.....	26

4.1 Treadmill Conveyor: Smooth Motion Across Varying Speeds and Loads

Consistent speed control is critical for treadmill conveyor belts. When a person runs on a treadmill, their stride disturbs the motion of the belt. The runner's stride will be choppy if the motor driving the belt cannot quickly provide enough torque to overcome the disturbance. This problem is exacerbated when the user changes speeds as part of their exercise regime. If the belt does not smoothly accelerate or decelerate it seems like the treadmill is not operating correctly. In addition, at low speeds when a user steps on the belt, their weight can cause the belt to stop.

InstaSPIN-MOTION was applied to a commercial treadmill using a 4-HP, 220-V AC induction motor to drive the conveyor belt. The treadmill was tested across a variable speed range: 42 rpm at the low end to 3300 rpm at top speed.

The customer found that InstaSPIN-MOTION's advanced controller automatically compensated for disturbances, keeping the speed consistent while running and across changing speeds. The controller prevented the belt from stopping at low speeds when a load was applied. In addition, a single gain was used to control the entire operating range.

4.2 Video Camera: Smooth Motion and Position Accuracy at Low Speeds

High-end security and conference room cameras operate at very low speeds (for example, 0.1 rpm) and require accurate and smooth position control to pan, tilt, and zoom. The motors that drive these cameras are difficult to tune for low speed, and they usually require a minimum of four tuning sets. In addition, there can be choppy movement at startup, which results in a shaky or unfocused picture.

InstaSPIN-MOTION was applied to a high-precision security camera driven by a 2-pole BLDC motor with a magnetic encoder. InstaSPIN-MOTION was able to control both velocity and position using a single tuning parameter that was effective across the entire operating range. SpinTAC Move was used to control the motor jerk, resulting in smooth startup.

4.3 Washing Machine: Smooth Motion and Position Accuracy at Low Speeds

Cycle transitions, changing loads, and environmental disturbances cause significant wear and tear on motors. Automatic, real-time reduction of disturbances can extend the life and performance of motors.

Consider washing machines, for example. [Figure 4-1](#) displays the motion profile for three stages of a standard washing machine. The first stage represents the agitation cycle, rotating between 250 rpm and -250 rpm, repeatedly. The second and third stages represent two different spin cycles. The second stage spins at 500 rpm and the third stage spins at 2000 rpm. This profile was easily created using SpinTAC Plan (documented in the [InstaSPIN-FOC and InstaSPIN-MOTION User's Guide](#)).

InstaSPIN-MOTION was applied to a washing machine application. The SpinTAC Plan trajectory planning feature was used to quickly build various states of motion (speed A to speed B) and tie them together with state based logic (see [Figure 2-4](#)).

The washing machine application was run twice — once using a standard PI controller and once using LineStream's SpinTAC controller. The data was then plotted against the reference curve for comparison.

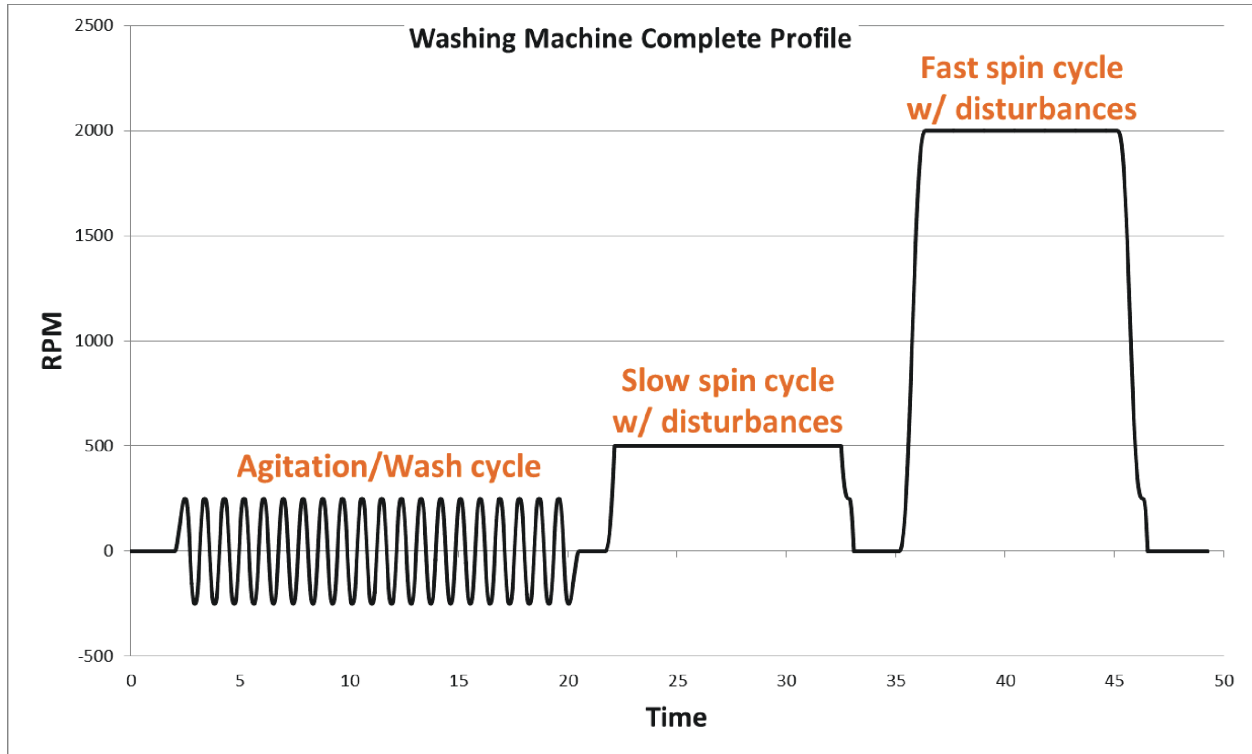

Figure 4-1. Washing Machine Profile

Agitation Cycle

During agitation, the motor switched between the 250 rpm and -250 rpm setpoints 20 times. The results, shown in Figure 4-2, demonstrate that InstaSPIN-MOTION more closely matched the reference profile. Additionally, the maximum error for PI was 91 rpm ($341 - 250 = 91$ rpm); whereas, the maximum error for SpinTAC was 30 rpm ($280 - 250 = 30$ rpm).

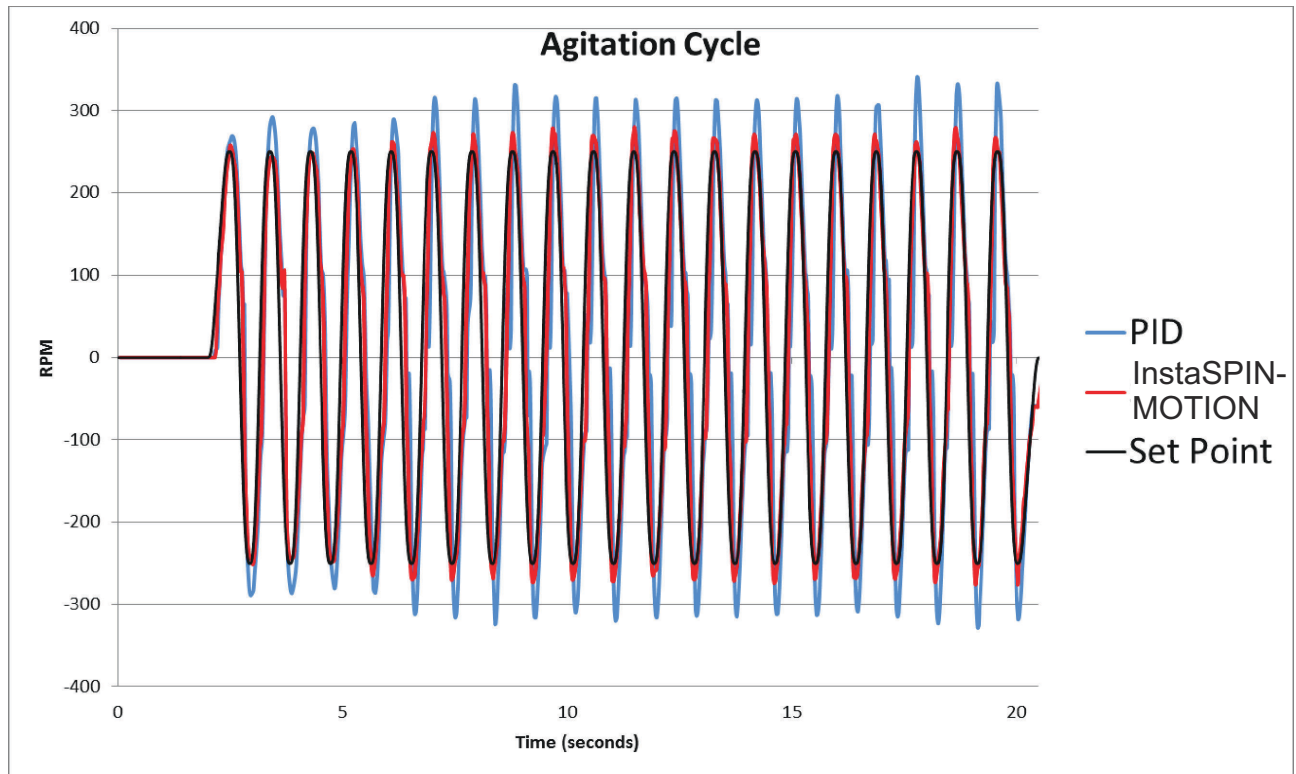

Figure 4-2. InstaSPIN-MOTION Minimizes Error

Spin Cycles

For the first spin cycle, the objective is to maintain 500 rpm, even when disturbances are introduced. [Figure 4-3](#) shows that InstaSPIN-MOTION recovered from disturbances more quickly, and with less oscillation, than the PI controller. Additionally, InstaSPIN-MOTION does not suffer from the overshoot and undershoot shown by the PI controller when it tries to reach the initial 500 rpm setpoint.

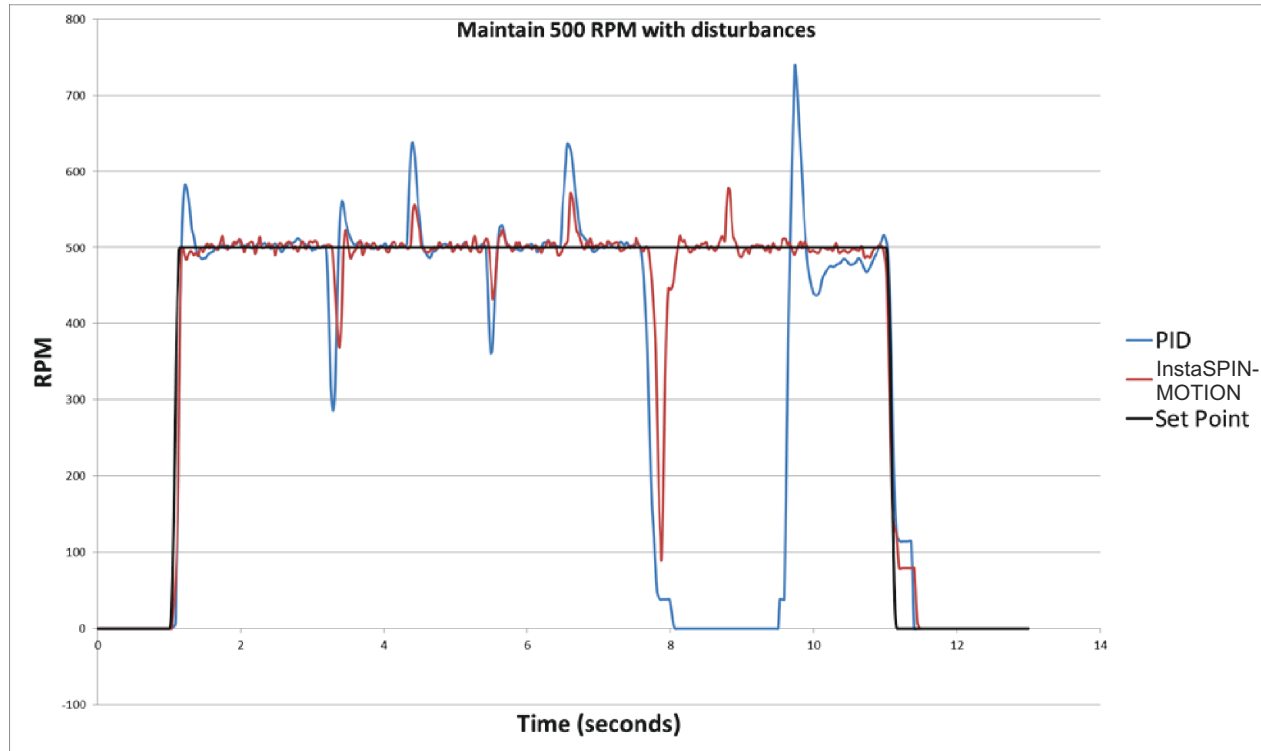
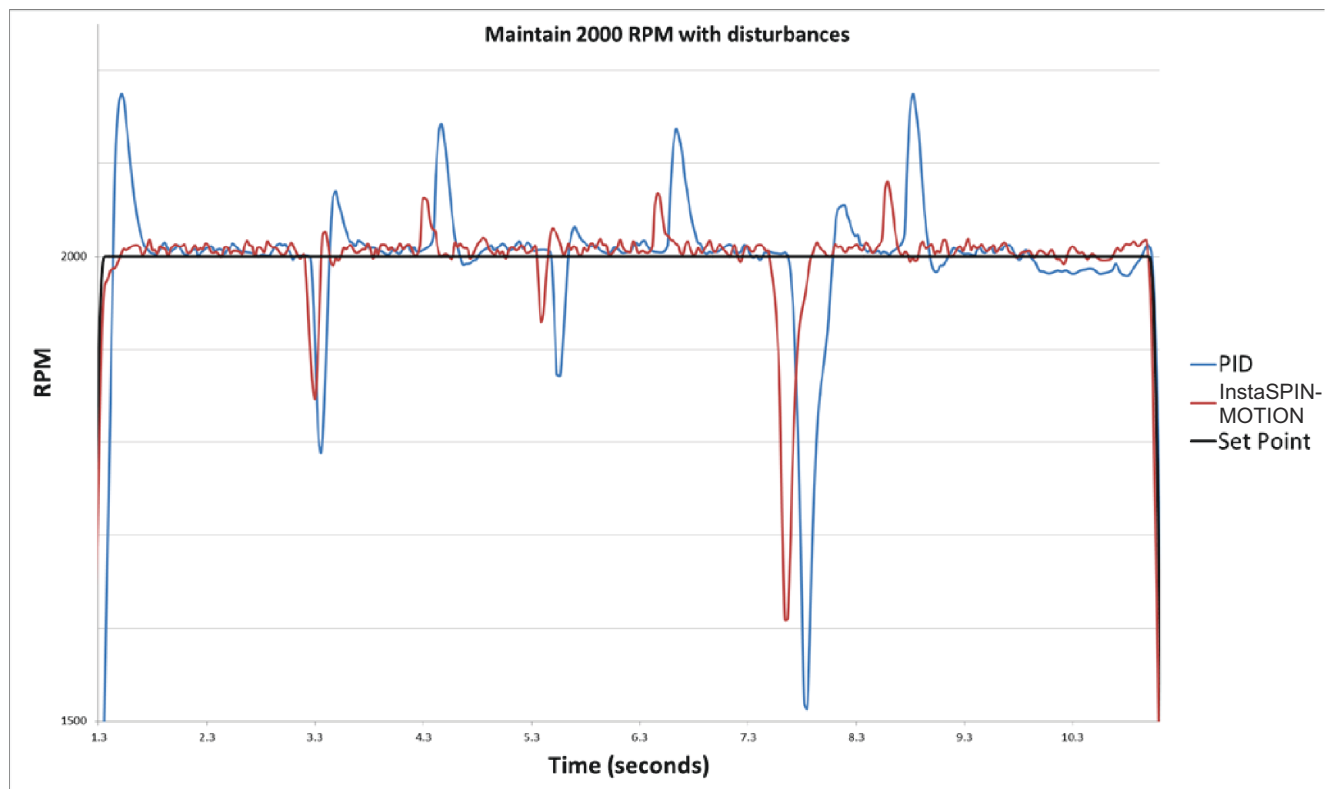

Figure 4-3. First Spin Cycle - 500 rpm

During the second spin cycle, shown in [Figure 4-4](#), the SpinTAC controller consistently recovered from disturbances at 2000 rpm more quickly, and with less oscillation, than the PI controller. Note that SpinTAC does not suffer from the overshoot and undershoot shown by the PI controller when it tries to reach the initial 2000 rpm setpoint.



Additionally, the PI controller could not recover from the ramp disturbance at the 9.75 second mark. Instead, it shows a steady-state error of roughly 20 rpm.

4.4 InstaSPIN-MOTION Works Over the Entire Operating Range

Both the InstaSPIN-MOTION controller and the PI controller were tuned once, before executing the washing machine application. From the examples shown above, it is evident that InstaSPIN-MOTION's tuning works over the entire operating range. Whether the motor switches between the 250 rpm and -250 rpm, or maintains 500 rpm or 2000 rpm spin cycles, there is no need for new tuning sets.



Evaluating InstaSPIN-MOTION Performance

5.1 Overview.....	28
5.2 Velocity Control Performance: SpinTAC vs PI.....	30
5.3 Position Control Performance: SpinTAC vs PI.....	41

5.1 Overview

Large original equipment manufacturers (OEMs) may work with external design houses to optimize their tuning parameters. However, many small and medium size OEMs are challenged by tuning their own PI controls. With InstaSPIN-MOTION, OEMs can save weeks of tuning time.

While PI controls are versatile and applicable to numerous control systems, the tuning process can be complex and time-intensive. Similarly, performance of PI loops can be unpredictable over a wide operating range and as system dynamics change over time. While the use of advanced control techniques, such as model-based compensation, can address these challenges, they require significant time for implementation and testing. They also add complexity to the system, and can result in performance degradation when the system dynamics vary.

InstaSPIN-MOTION addresses these challenges by replacing traditional PI controls. The advantages are highlighted in [Table 5-1](#). InstaSPIN-MOTION incorporates advanced control features, such as feed-forward, an observer, and can be tuned in a fraction of the time required to tuned PI control. Instead of having to tune multiple control parameters, the SpinTAC controller can be tuned by adjusting a single parameter for both position and speed. Once tuned, it performs across a wide-operating range.

Table 5-1. PI vs InstaSPIN-MOTION

Topic	PI Controllers	InstaSPIN-MOTION
Performance	Unpredictable across varying speeds and loads.	Compensates for disturbance across the operating range.
Tuning Parameters	Multiple sets required for different speed and load points.	Single setting typically effective over the entire operating range.
Tuning Process	Complex and underestimated.	Simple - the identification process takes a few minutes.
Startup	Difficult - requires control expertise.	Simple - embeds the expertise.
Disturbance Recovery	Overshoot and undershoot when disturbances are introduced and during transitions.	Advanced disturbance rejection holds set points more closely.

InstaSPIN-MOTION is designed to perform in all kinds of systems. In systems that remain unaffected by outside influences, the InstaSPIN-MOTION controller demonstrates its performance benefits by eliminating overshoot and undershoot during transitions.

In systems that are affected by outside disturbances, the InstaSPIN-MOTION controller provides advanced disturbance rejection, holding set points more closely than is achievable with standard PI control, as shown in [Figure 5-1](#) and [Figure 5-2](#).

Getting the best possible performance out of your motion system is important. A poorly tuned regulator can result in wasted energy, wasted material, or an unstable system. It is important that speed and position controller performance be evaluated at many different speed and load operating points in order to determine how well it works in your application.

Speed and position controllers can be compared on a number of different factors. However, two metrics — disturbance rejection and profile tracking — can be used to test performance and determine how well your controller is tuned for your application.

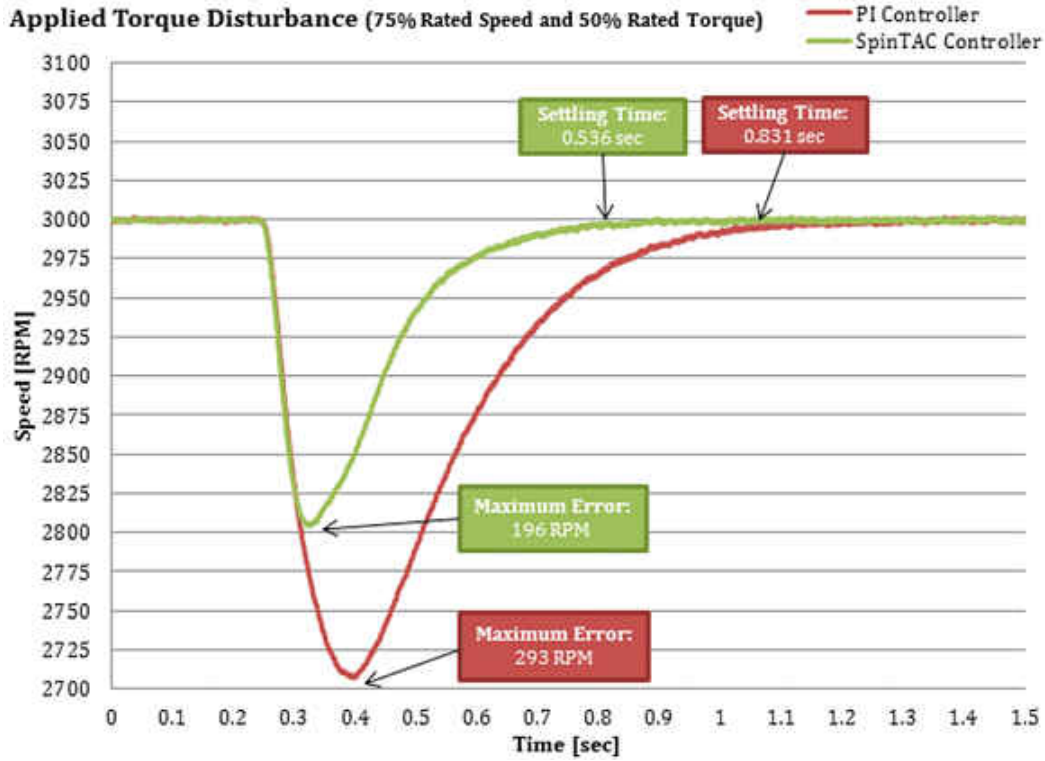

Figure 5-1. Applied Torque Disturbance Comparison

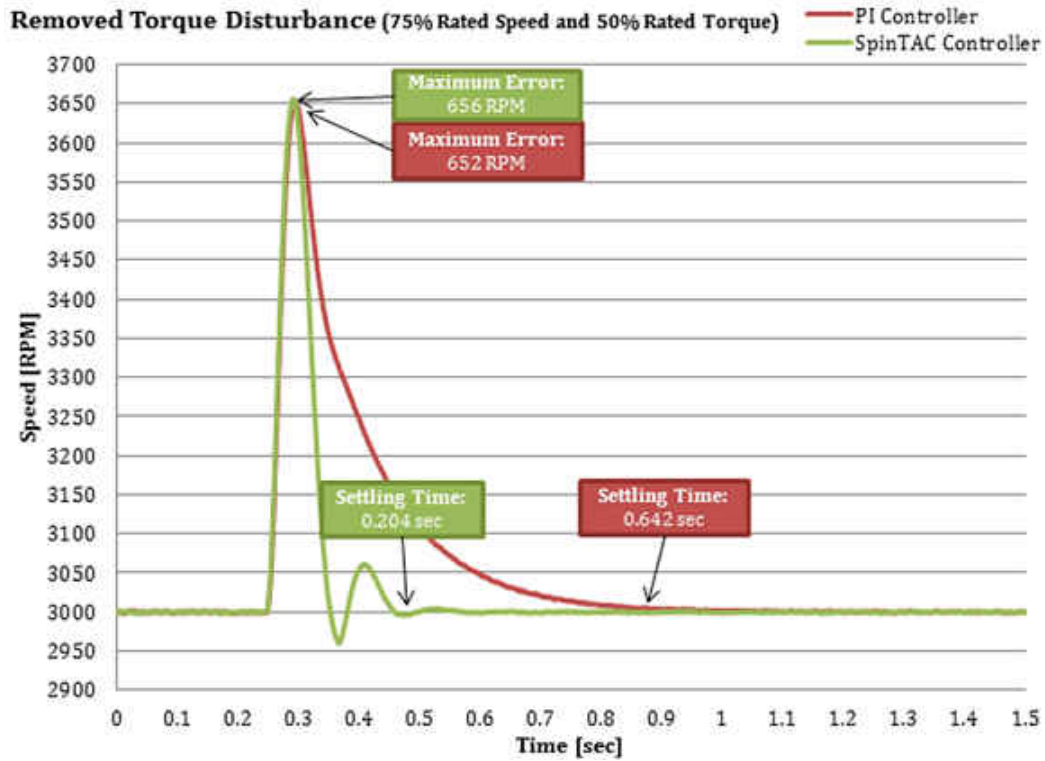

Figure 5-2. Removed Torque Disturbance Comparison

5.2 Velocity Control Performance: SpinTAC vs PI

For Velocity control, the performance of the SpinTAC controller was compared to a PI controller. Both controllers used the FAST software observer.

Each controller was tuned using the same method. For the Estun motor these controllers were tuned experimentally by injecting 25% rated torque (45 oz-in) disturbances while running the motor at 100% rated speed (3000 rpm). This resulted in the following gains:

- PI Speed Controller
 - $K_p = 20$
 - $K_i = 0.098$
- SpinTAC Speed Controller
 - Bandwidth = 35 radians/s

The inertia used by the SpinTAC speed controller was estimated with the dyne coupled with the motor. The value was found to be 0.483 A / (krpm/s).

For the Teknic motor these controllers were tuned experimentally by injecting 50% rated torque (19.4 oz-in) disturbances while running the motor at 50% rated speed (2000 rpm). This resulted in the following gains:

- PI Speed Controller
 - $K_p = 9$
 - $K_i = 0.03$
- SpinTAC Speed Controller
 - Bandwidth = 16 radians/s

The inertia used by the SpinTAC speed controller was estimated with the dyne coupled with the motor. The value was found to be 4.23 A / (krpm/s).

These gains were held constant throughout all of the tests. This was done purposefully in order to highlight the wide operating range of the SpinTAC speed controller.

5.2.1 Disturbance Rejection

Disturbance rejection tests the controller's ability to compensate for external disturbances, which impact the motor speed. In the disturbance rejection test, a load torque is applied to the system, held on for a short period of time, and then removed from the system. [Figure 5-3](#) is an example of a disturbance rejection test. The response of the controller is measured using the maximum speed error and settling time. The maximum speed error shows the deviation from the goal speed, and is an indication of how aggressively your controller is tuned. Aggressive tuning produces a low maximum error. In [Figure 5-3](#) the PI controller presents a greater maximum speed error than the SpinTAC controller, indicating that the SpinTAC controller is more responsive in compensating for system error.

Settling time refers to the amount of time from the point when the disturbance happens until the speed returns to a fixed band around the goal speed. This is also an indication of how aggressively your control loop is tuned. If the controller is tuned too aggressively it will have a long settling time because it will oscillate around the goal speed before settling. In [Figure 5-3](#), the PI controller has a longer setting time that the SpinTAC controller. Note that there is very little oscillation in either controller as they settle back to the goal speed.

Disturbance Rejection Test (50% Rated Speed and 50% Rated Torque)

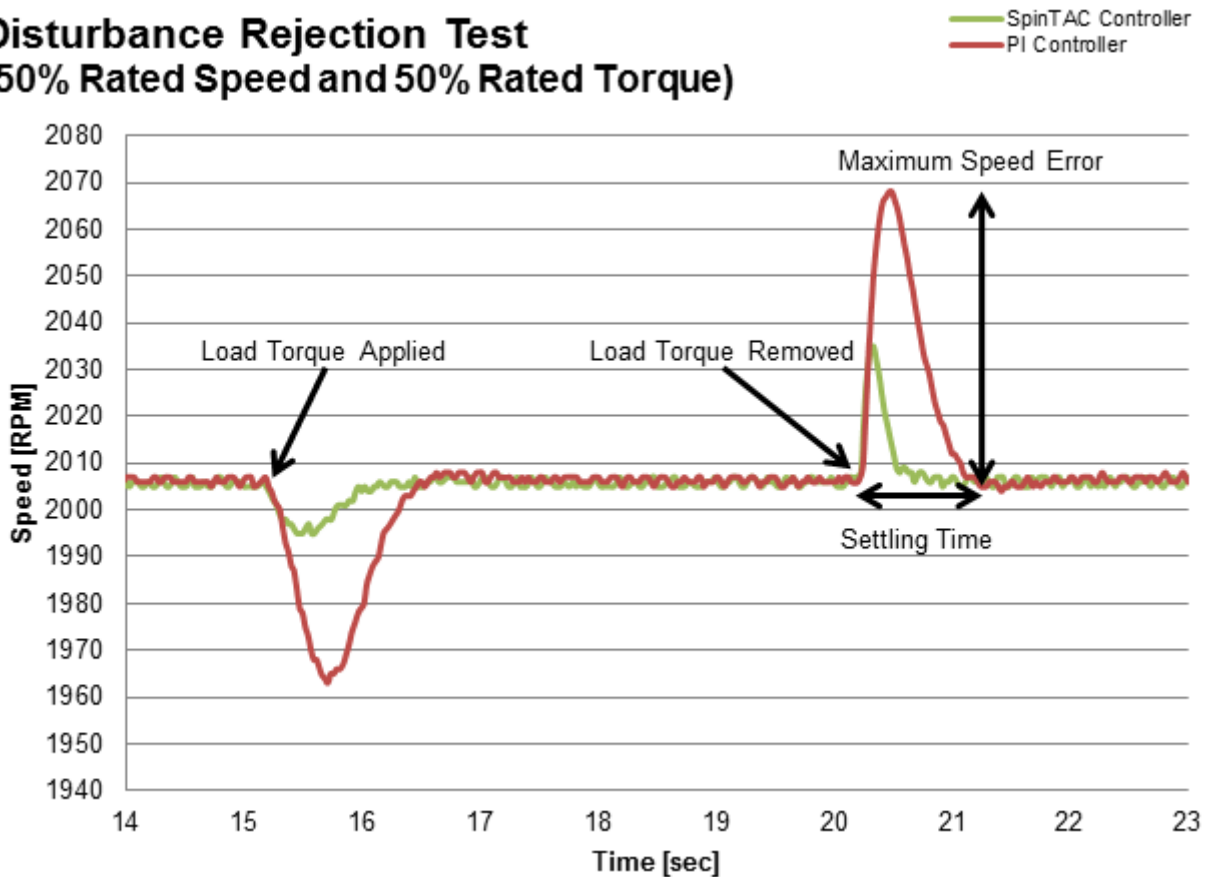

Figure 5-3. Disturbance Rejection Test of Maximum Speed Error and Settling Time

There may be a difference in settling time when loads are applied to the system, and when loads are removed from the system. When a load is applied to a motor, the controller may reach saturation, at which point the controller's output is limited. However, when the load is removed, the motor transitions from a loaded state to zero load. The settling time and overshoot is entirely dependent upon the controller. Figure 5-4 shows an example of this case where the controller was placed into saturation.

When performing disturbance rejection testing it is important to test at multiple speed and load combinations. Speed controllers have different performance characteristics when placed into different situations. In order to properly evaluate the effectiveness of your speed controller, tests should be performed across the entire application operating range. The test results will indicate whether the controller will meet the application specifications, or whether the controller needs to be tuned multiple times for different operating points (gain scheduling). The following test results were obtained for nine different speed and load combinations in order to test a wide range of operation.

It is also important to be able to create repeatable disturbances. This can be accomplished using a dynamometer or a disturbance motor. Creating repeatable disturbance is an important factor when evaluating multiple controllers. If test conditions cannot be replicated, it is difficult to adequately compare the responses of multiple controllers.

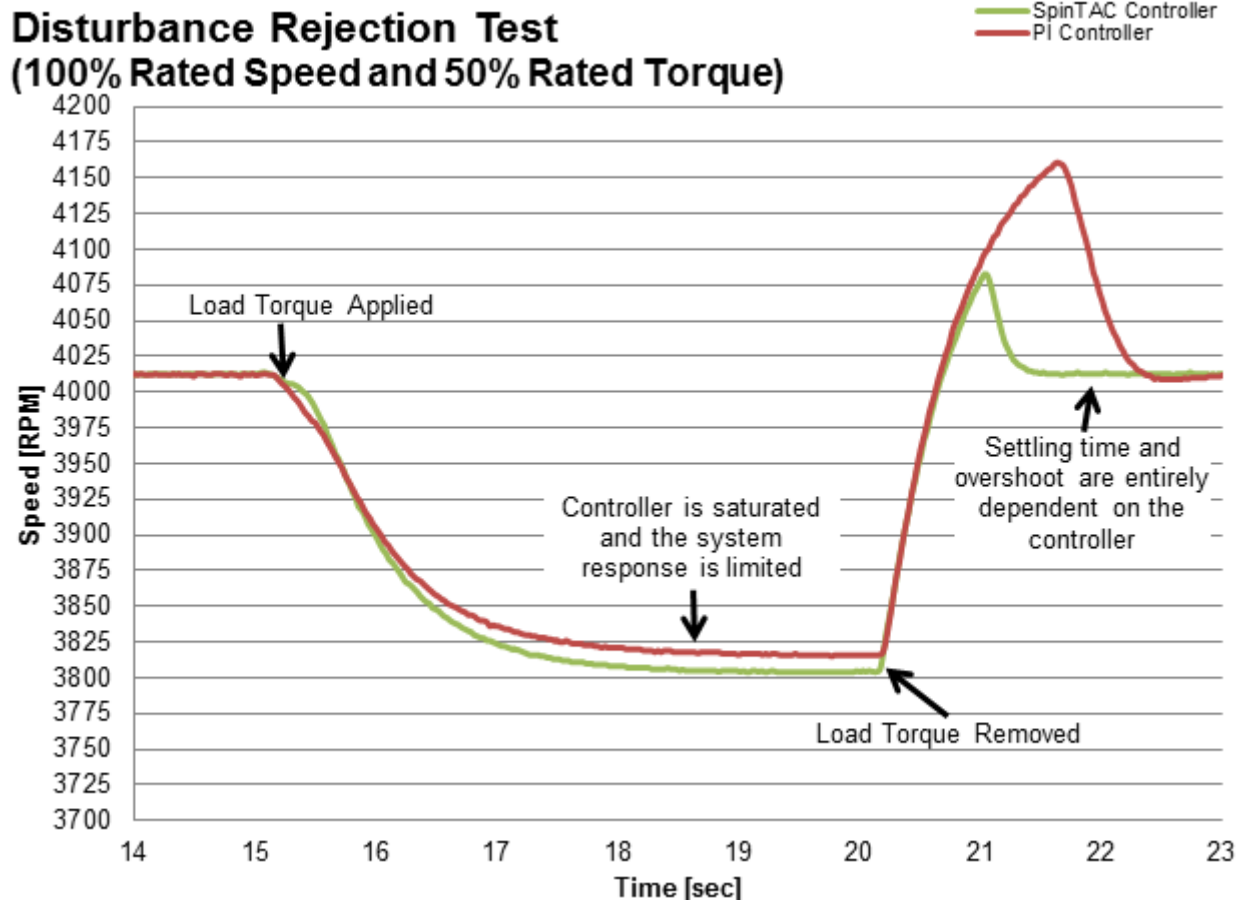

Figure 5-4. Disturbance Rejection Test with Controller Saturation

For the test results shown in [Table 5-2](#) and [Table 5-3](#), a disturbance load profile was created that applied 25%, 50%, and 100% of rated torque to the motor. The test compared the performance of the SpinTAC speed controller to a standard PI controller, and the following parameters were measured for each:

- Average Recovery Time (from the point of disturbance until within 2% of the target speed): The average recovery time was measured when the load was applied and when the load was removed from the system.
- Absolute Average Speed Error: The positive or negative deviation from the goal speed when a system disturbance is introduced.
- Maximum Speed Error: The maximum deviation from goal speed when a disturbance is introduced.

Table 5-2. SpinTAC vs PI Disturbance Rejection Test Results (Teknic Motor)

	1000 rpm			2000 rpm			4000 rpm		
	SpinTAC	PI	SpinTAC Advantage (percentage improvement over PI)	SpinTAC	PI	SpinTAC Advantage (percentage improvement over PI)	SpinTAC	PI	SpinTAC Advantage (percentage improvement over PI)
25% rated torque									
Avg Recovery Time(s) - load applied	1.34	1.84	27.34	1.20	1.67	28.27	0.85	1.79	52.46
Avg Recovery Time(s) - load removed	0.43	0.93	53.29	0.41	0.89	53.55	0.54	1.02	46.82
Abs Avg Error (rpm)	3.06	4.16	26.44	5.98	6.63	9.74	12.23	12.42	1.53
Avg Max Error (rpm)	17	29	41.38	16	27	40.74	18	26	30.77
50% rated torque									
Avg Recovery Time(s) - load applied	1.01	1.33	23.81	1.01	1.45	30.34	4.98	5.04	1.19
Avg Recovery Time(s) - load removed	0.51	1.04	51.30	0.56	1.06	46.52	1.33	2.54	47.20
Abs Avg Error (rpm)	3.7	7.9	53.16	6.21	10.2	39.12	81.92	87.66	6.55
Avg Max Error (rpm)	36	71	49.30	35	69	49.28	197	185	-6.49
100% rated torque									
Avg Recovery Time(s) - load applied	0.76	1.20	36.67	0.78	1.16	32.73	4.98	5.08	1.95
Avg Recovery Time(s) - load removed	0.40	1.00	59.84	0.52	1.02	48.89	1.90	3.12	39.09
Abs Avg Error (rpm)	5.4	15.39	64.91	7.99	17.54	54.45	345.42	360.74	4.25
Avg Max Error (rpm)	87	158	44.94	80	151	47.02	829	837	0.96

Table 5-3. SpinTAC vs PI Disturbance Rejection Test Results (Estun Motor)

	750 rpm			1500 rpm			3000 rpm		
	SpinTAC	PI	SpinTAC Advantage (percentage improvement over PI)	SpinTAC	PI	SpinTAC Advantage (percentage improvement over PI)	SpinTAC	PI	SpinTAC Advantage (percentage improvement over PI)
25% rated torque									
Avg Recovery Time(s) - load applied	0.69	1.52	54.34	0.60	1.36	57.96	0.60	1.35	52.87
Avg Recovery Time(s) - load removed	0.42	1.12	61.75	0.40	1.03	61.58	0.41	1.01	59.01
Abs Avg Error (rpm)	1.97	3.81	48.13	3.05	5.25	41.90	6.16	9.08	32.12
Avg Max Error (rpm)	37	47	21.28	36	47	23.40	38	49	22.45
50% rated torque									
Avg Recovery Time(s) - load applied	0.35	1.31	72.97	0.33	1.33	76.23	0.36	1.13	67.07
Avg Recovery Time(s) - load removed	0.44	1.36	67.32	0.40	1.25	68.02	0.364	1.14	67.33
Abs Avg Error (rpm)	2.67	5.91	54.87	3.86	7.13	45.89	6.89	11.14	38.19
Avg Max Error (rpm)	76	96	20.83	74	95	22.11	76	97	21.65
100% rated torque									
Avg Recovery Time(s) - load applied	0.56	2.26	75.09	0.5	2.14	76.68	4.98	5.06	1.58
Avg Recovery Time(s) - load removed	0.38	1.16	66.78	0.4	0.92	55.93	0.44	0.74	40.60
Abs Avg Error (rpm)	8.64	57.98	85.09	9.54	59.95	84.09	94.25	103.74	9.15
Avg Max Error (rpm)	440	697	36.87	440	665	33.83	585	646	9.44

5.2.2 Reference Tracking

Reference tracking tests how well the controller follows a changing target speed. The two metrics to evaluate in this testing are the maximum error and the absolute average error. The maximum speed error shows how much the controller overshoots while changing speeds. This is an indication of how aggressively your controller is tuned. If your controller is not tuned aggressively enough, the speed will overshoot the target, and take a long time to recover. If the controller is tuned too aggressively it will overshoot, and then oscillate as it settles on the goal speed. If the controller is correctly tuned, it will minimally overshoot and then smoothly return to the goal speed.

Absolute average error is an average of the absolute value of the instantaneous speed error over the entire profile. This measure shows the amount of deviation throughout the entire profile. It takes into account all of the little errors as the motor is running. If the controller is tuned too aggressively it will result in larger absolute average error because the controller will be oscillating throughout the profile. If the controller is not tuned aggressively enough, it will result in a larger absolute average error because the motor is continuously lagging the profile.

A tracking profile was created to exercise the motor in a repeatable a pattern. The profile was used to compare the performance of SpinTAC and PI controllers. The profile included quick transitions as well as gentle sweeping transitions. [Figure 5-5](#) is a plot of the speed profile used during the reference tracking tests. The blocked off areas are areas where additional plots will be shown detailing the differences between the SpinTAC and PI controllers.

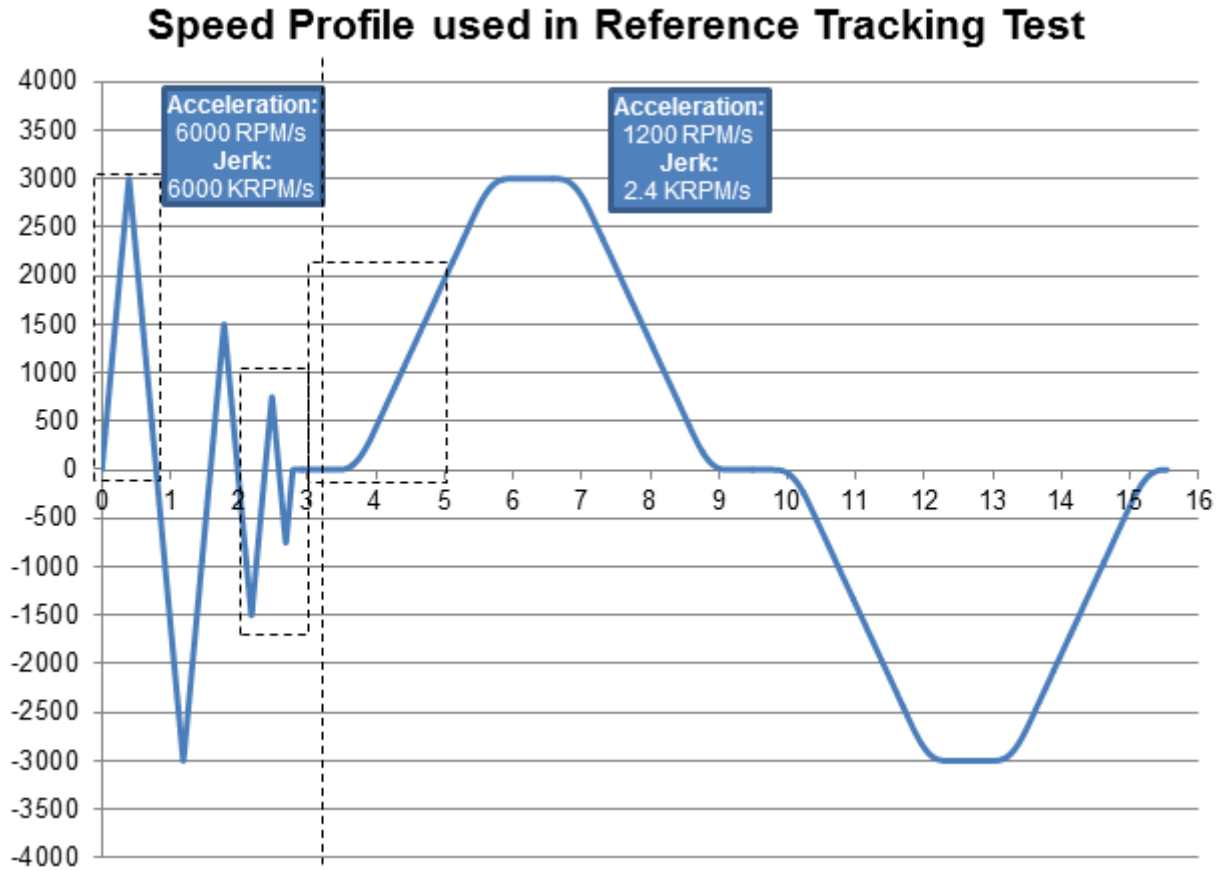

Figure 5-5. Speed Profile Used During Reference Tracking Test

There are some differences between the SpinTAC and PI controller that should be called out and evaluated in addition to the absolute average error and maximum error of the profile tracking. [Figure 5-6](#) shows how the PI controller greatly overshoots the speed reference when it makes a very drastic change. It then takes quite a bit of time to recover from that initial error, while the SpinTAC controller has no problems with the drastic reference change.

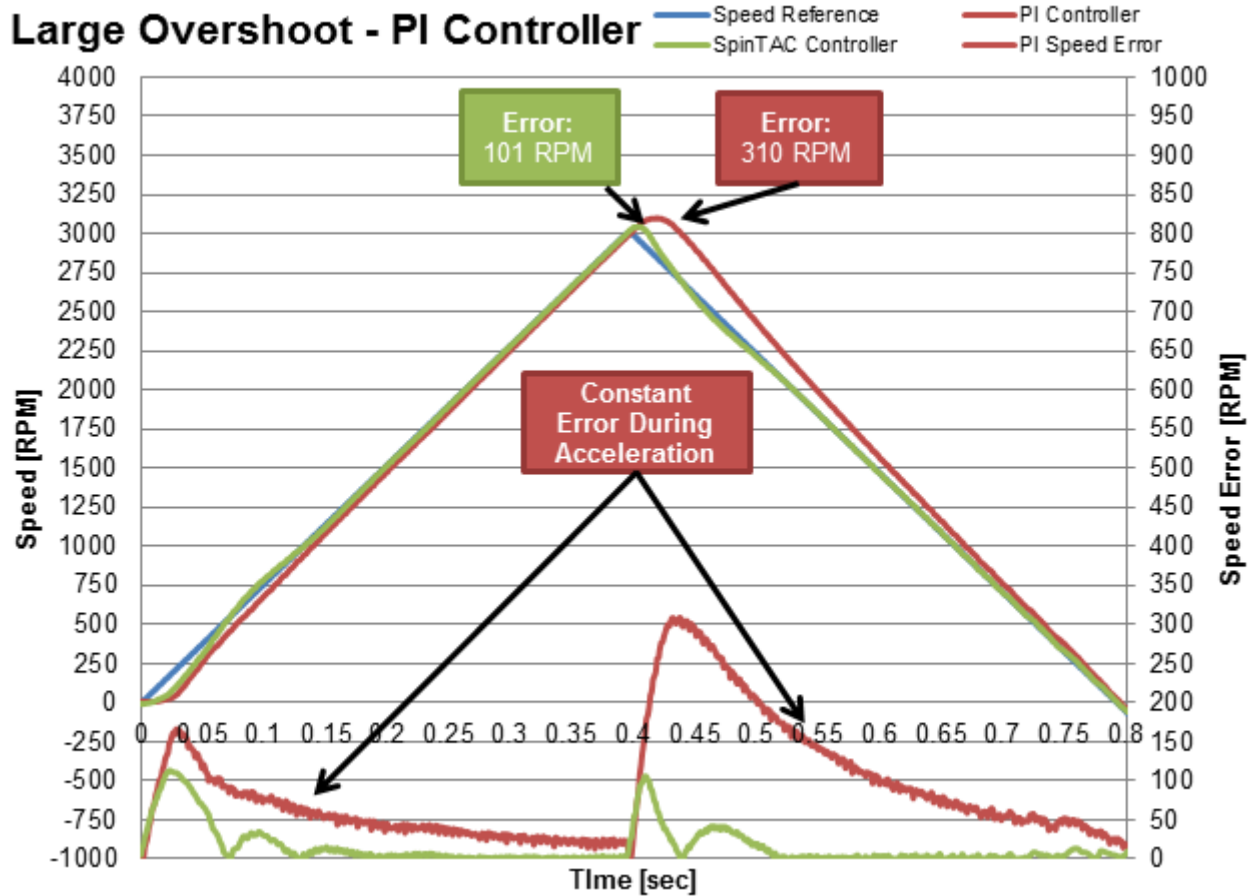

Figure 5-6. Large Overshoot for PI Controller During Reference Tracking

Figure 5-7 shows how the PI controller falls behind the reference as the drastic changes in the reference continue. The PI controller cannot keep up, while the SpinTAC controller has no difficulty in accurately tracking the speed reference.

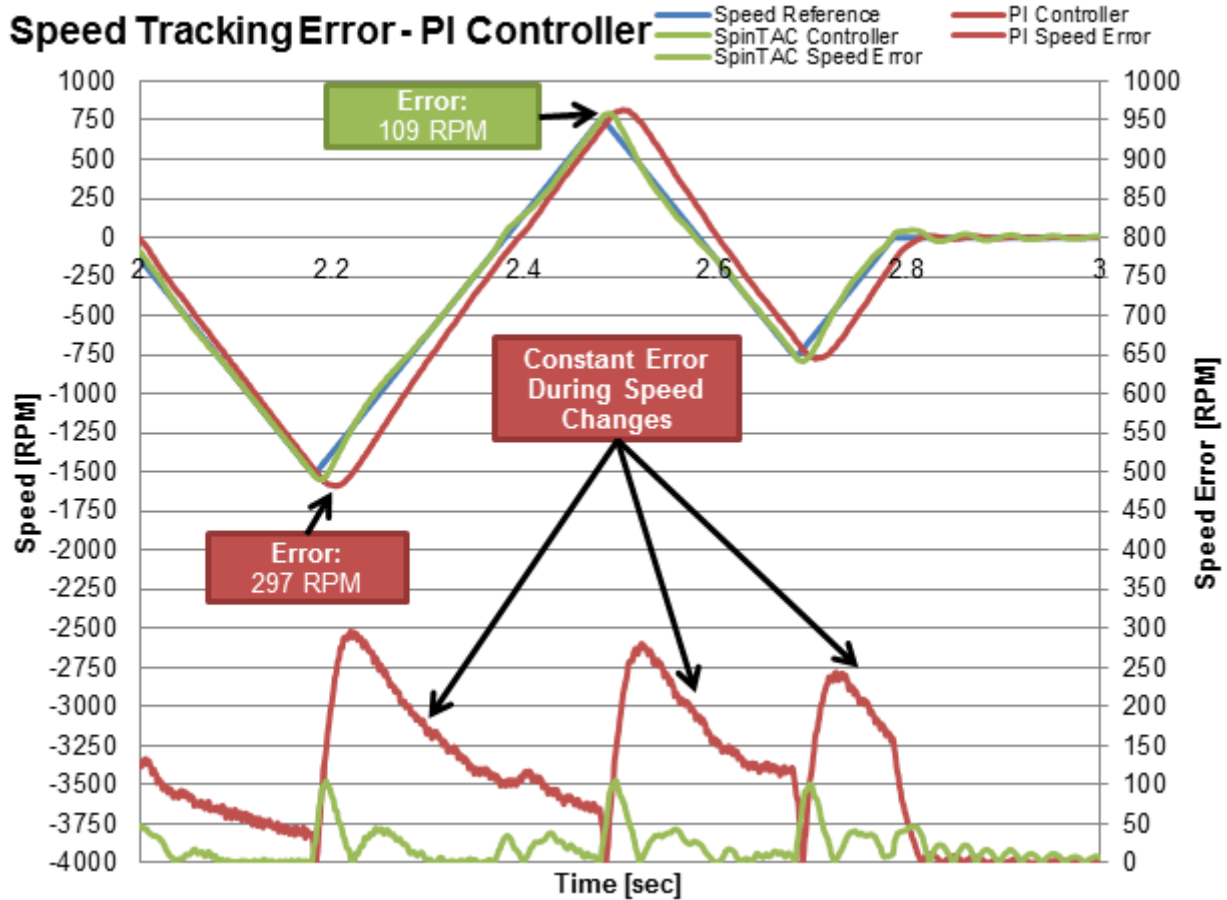

Figure 5-7. Speed Tracking Error for PI Controller During Reference Tracking

When starting from zero speed with a slow trajectory change, the PI controller has more difficulty than the SpinTAC controller. This is due to the SpinTAC controller's superior ability to track a changing reference signal. Figure 5-8 shows an example of this from the reference tracking test.

It is important to test multiple speeds and accelerations in your profile as well as multiple different loads. Speed controllers have different performance characteristics when placed into different situations. In order to properly evaluate the effectiveness of your speed controller, tests should be conducted across the entire application range. This includes when you design the profile for testing. Care needs to be taken to ensure that the application speeds and accelerations are built into the profile. The results of these tests will inform you if your controller will meet the application specifications or if your controller needs to be tuned multiple times for different operating points. Notice wide range of speeds and accelerations that are tested in Figure 5-5.

It is also important to be able to create repeatable profiles. Creating a repeatable profile can be done using SpinTAC Move and SpinTAC Plan (the *InstaSPIN-FOC and InstaSPIN-MOTION User's Guide* provides detailed information on SpinTAC Move and SpinTAC Plan and lab projects are available in the [MotorWare](#) repository). Repeatable profiles are required so that all controllers are tested using the same reference in the same order and for the same length of time. This ensures that test conditions are as identical as possible. The profile for this test was made using SpinTAC Move and SpinTAC Plan to ensure that an identical profile was presented to both the SpinTAC and PI controllers.

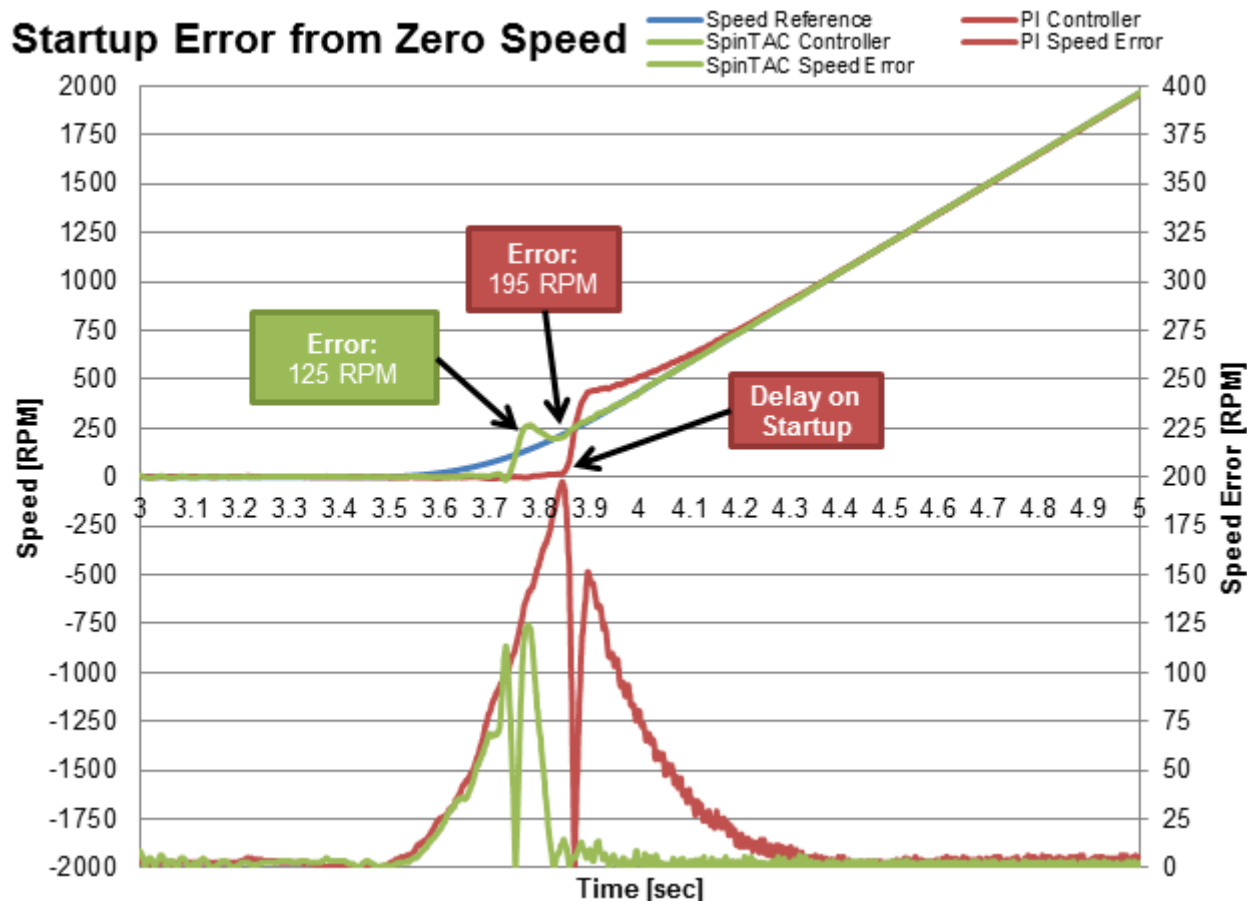

Figure 5-8. Startup Error From Zero Start for PI Controller

The following parameters were measured:

- Absolute Average Speed Error: The positive or negative deviation from the goal speed over the entire speed profile.
- Maximum Speed Error: The maximum deviation from the goal speed during the speed profile.

Table 5-4. SpinTAC vs PI Profile Tracking Test Results

	Trapezoidal Curve			st-Curve		
	SpinTAC	PI	SpinTAC Advantage (percentage improvement over PI)	SpinTAC	PI	SpinTAC Advantage (percentage improvement over PI)
Teknic Motor						
Abs Avg Error (rpm)	6.01	19.94	69.86	5.98	19.51	69.35
Max Error (rpm)	266.06	430.00	38.13	263.00	334.71	21.42
Estun Motor						
Abs Avg Error (rpm)	5.39	16.11	66.54	5.73	16.124	64.46
Max Error (rpm)	248.29	312.74	20.61	181.64	307.61	40.95

5.2.3 Step Response

Step response tests how quickly a controller can respond to a sudden input change. The two metrics to evaluate during this testing are settling time and maximum overshoot. This test is also a measure of stability of your controller. If the controller oscillates upon reaching the goal speed, then it is not very stable.

A step profile was applied to each controller. This step input bypassed the profile generator. The following parameters were measured:

- Settling Time (from the step input until within 2% of the target speed): The settling time reflects how long it takes the controller to reach the goal speed and bring the speed of the motor within a narrow band around the goal speed.
- Maximum Overshoot: The maximum speed the motor reaches after the step input.

Figure 5-9 compares the step responses of the SpinTAC and PI controllers. It also gives a visual representation of how these metrics were calculated. The SpinTAC controller was able to reach the goal speed with zero overshoot and the minimal amount of settling time. It achieved the minimal amount of settling time because the controller did not allow the motor speed to exceed the goal speed.

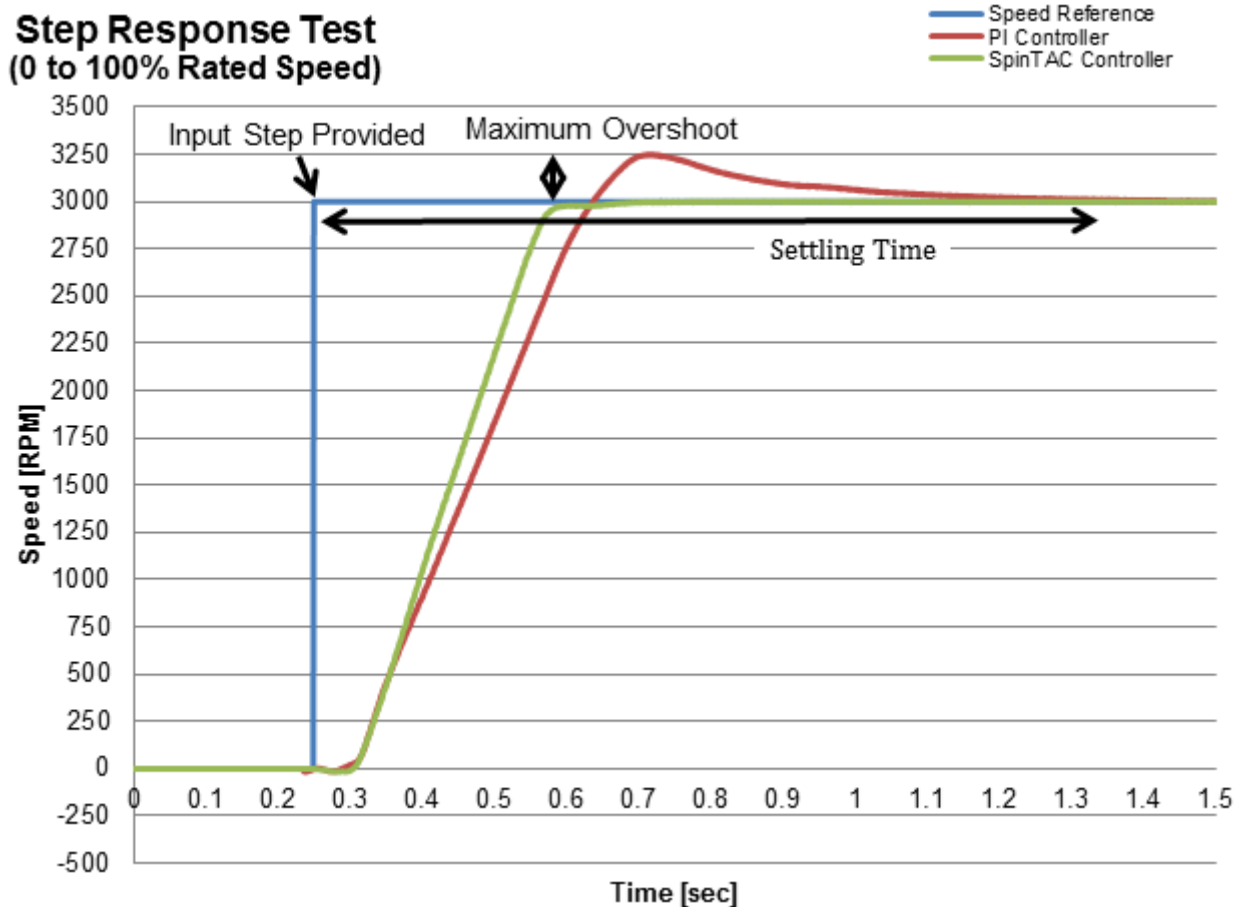

Figure 5-9. Step Response Test of Maximum Overshoot and Settling Time

Table 5-5. SpinTAC vs PI Step Response Test Results (Teknic Motor)

Settling Time(s)			Overshoot (rpm)		
SpinTAC	PI	SpinTAC Advantage (percentage improvement over PI)	SpinTAC	PI	SpinTAC Advantage (percentage improvement over PI)
0-4000 rpm					
2.67	3.45	22.66	73	140.4	48.01
2.48	3.39	26.84	71.5	139.6	48.78
2.52	3.51	28.21	70.1	138.2	49.28
2.54	3.59	29.25	71.5	138.2	48.26
2.64	3.39	22.12	70.1	139.6	49.79
0-2000 rpm					
0.84	1.51	44.37	317	319.6	0.81
0.9	1.42	36.62	325	320.3	-1.47
0.86	1.42	39.44	332	320.3	-3.65
0.93	1.45	35.86	390	320.3	-21.76
0.92	1.42	35.21	325	319.6	-1.69
0-1000 rpm					
0.65	1.28	49.38	239	316.2	24.41
0.79	1.1	28.18	269	317.6	15.3
0.57	1.27	55.12	195	319.1	38.89
0.59	1.38	57.25	203	318.4	36.24
0.59	1.18	50	24.16	318.4	38.76

Table 5-6. SpinTac vs PI Step Response Test Results (Estun Motor)

Settling Time(s)			Overshoot (rpm)		
SpinTAC	PI	SpinTAC Advantage (percentage improvement over PI)	SpinTAC	PI	SpinTAC Advantage (percentage improvement over PI)
0-3000 rpm					
0.44	1.16	61.81	2.9	250.5	98.84
0.54	1.1	50.91	2.9	251.2	98.85
0.38	1.32	71.21	2.9	252.7	98.85
0.4	1.21	66.94	2.9	252	98.85
0.42	1.41	70.21	2.9	252.7	98.85
0-1500 rpm					
0.25	1.12	78	3.7	261.5	98.59
0.37	1.3	71.54	19	262.2	92.75
0.47	1.12	58.04	3.7	263.7	98.6
0.42	1.1	61.82	3.7	263.7	98.6
0.44	1.13	61.06	3.7	262.9	98.59
0-750 rpm					
0.41	0.81	49.63	63.72	286.4	77.75
0.32	0.61	47.54	76.17	179.44	57.55
0.43	0.71	39.44	71.04	279.8	74.61
0.32	0.62	48.39	13.91	292.2	95.24
0.32	0.73	56.16	24.16	177.97	86.42

5.3 Position Control Performance: SpinTAC vs PI

The performance of SpinTAC Position Control was compared against a typical PI-PI control system. Each controller was tuned via the same method.

The Estun motor used a 2500-line encoder. Both controllers were tuned by injecting 25% rated torque (45 oz-in) disturbances while running the motor at 100% rated speed (3000 rpm), resulting in the following gains:

PI Control System

- Position Loop
 - $K_p = 20$
 - $K_i = 0.002$
- Speed Loop
 - $K_p = 23$
 - $K_i = 0.5$

SpinTAC Position Control (single gain for position and speed)

- Bandwidth = 36 radians/s

The inertia used by SpinTAC Position Control was estimated with the dyne coupled with the motor. The value was found to be 0.44 A / (krpm/s).

The Teknic motor used a 1000-line encoder. Both controllers were tuned by injecting 50% rated torque (19.4 oz-in) disturbances while running the motor at 50% rated speed (2000 rpm). This resulted in the following gains:

PI Control System

- Position Loop
 - $K_p = 17$
 - $K_i = 0.01$
- Speed Loop
 - $K_p = 1.2$
 - $K_i = 0.1$

SpinTAC Position Control (single gain for position and speed)

- Bandwidth = 50 radians/s

The inertia used by SpinTAC Position Control was estimated with the dyne coupled with the motor. The value was found to be 0.07 A / (krpm/s).

The gains were held constant throughout all of the tests. This was done purposefully to highlight the wide operating range of SpinTAC Position Control.

5.3.1 Disturbance Rejection

The disturbance rejection tests demonstrate the controller's ability to compensate for external disturbances, which impact the motor position. In this test a load torque is applied to the system, held for short period of time, and then removed from the system. Figure 5-10 is an example of a disturbance rejection test. The response of the controller is measured using the maximum position error and settling time. The maximum position error shows the deviation from the goal position, and is an indication of how aggressively the controller is tuned. Aggressive tuning produces a low maximum error. In Figure 5-10, the PI controller presents a greater maximum error than the SpinTAC controller, indicating that the SpinTAC controller is more responsive in compensating for system error.

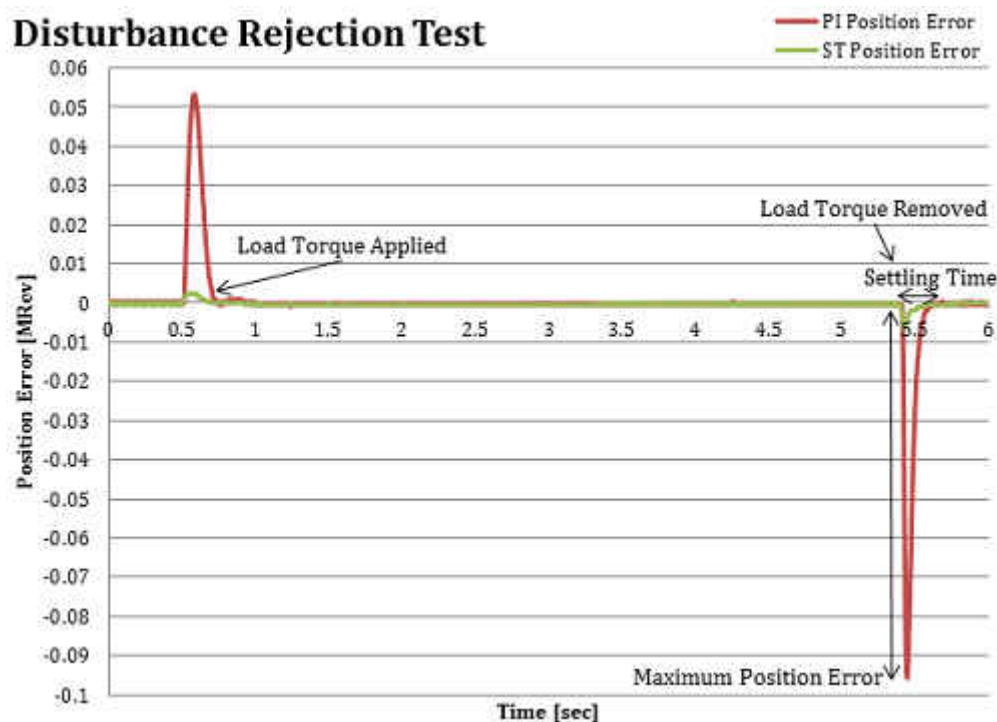

Figure 5-10. Disturbance Rejection Test of Maximum Position Error and Settling Time

Settling time refers to the amount of time from the point when the disturbance occurs until the position feedback returns to a fixed band around the goal position reference. This is also an indication of how aggressively the control loop is tuned. If the controller is tuned too aggressively it will have a long settling time, and will oscillate around the goal position before settling. Figure 5-10 shows that the PI controller has a longer settling time than the SpinTAC controller. Note that there is little oscillation from either controller as they return to the goal position.

When doing disturbance rejection testing it is important to test at multiple speed and load combinations. In order to properly evaluate the effectiveness of your position controller, tests should be done across the entire speed range since the speed at which the motor is running will impact the ability to control the position. The test results will indicate whether the controller will meet the application specifications or whether the controller needs to be tuned multiple times for different operating points. The disturbance rejection tests were conducted at nine different speed and load combinations (Table 5-7 and Table 5-8) in order to test a wide range of operation.

It is also important to be able to create repeatable disturbances. This can be accomplished using a dynamometer or a disturbance motor. Creating repeatable disturbance is an important factor when evaluating multiple controllers. If test conditions cannot be replicated, it is difficult to adequately compare the responses of multiple controllers.

For the following test results, a disturbance load profile was created that applied 25%, 50%, and 100% of rated torque to the motor. The test results compare the performance of SpinTAC Position Control to a standard PI position control system. The following parameters were measured:

- Average Recovery Time (from the point of disturbance until within 2% of the reference position) - the average recovery time was measured when the load was applied, and when the load was removed from the system.
- Absolute Average Position Error - positive or negative deviation from the reference position (in mechanical degrees) when a system disturbance is introduced.
- Maximum Position Error - maximum deviation (in mechanical degrees) from the goal position when a disturbance is introduced.

Table 5-7. SpinTAC vs PI Position Control Disturbance Rejection Test Results (Teknic Motor)

	1000 rpm			2000 rpm			4000 rpm		
	SpinTAC	PI	SpinTAC Advantage (percentage improvement over PI)	SpinTAC	PI	SpinTAC Advantage (percentage improvement over PI)	SpinTAC	PI	SpinTAC Advantage (percentage improvement over PI)
25% rated torque									
Avg Recovery Time(s) - load applied	0.40	0.55	25.9	0.44	0.52	15.2	0.41	0.53	23.2
Avg Recovery Time(s) - load removed	0.2	0.50	59.6	0.25	0.38	33.6	0.20	0.39	49.5
Abs Avg Error (mechanical degrees)	3.22e-1	2.38	86.4	2.70e-1	1.94	86.1	2.63e-1	1.98	86.7
Avg Max Error (mechanical degrees)	17.57	132.01	86.7	17.06	130.43	86.9	15.80	127.62	87.6
50% rated torque									
Avg Recovery Time(s) - load applied	0.28	0.39	27.9	0.44	0.49	11.0	0.27	0.56	51.4
Avg Recovery Time(s) - load removed	0.23	0.51	55.3	0.25	0.39	35.5	0.25	0.45	44.2
Abs Avg Error (mechanical degrees)	6.12e-1	4.86	87.4	5.04e-1	4.21	88.0	5.04e-1	4.18	87.9
Avg Max Error (mechanical degrees)	35.68	270.54	86.8	34.63	267.01	87.0	33.41	253.84	86.8
100% rated torque									
Avg Recovery Time(s) - load applied	0.24	0.39	37.4	0.38	0.65	41.6	0.32	0.43	26.6
Avg Recovery Time(s) - load removed	0.26	0.64	59.7	0.28	0.43	35.3	0.32	0.42	23.8
Abs Avg Error (mechanical degrees)	1.15	11.52	90.0	1.08	13.75	92.1	8.64e-1	8.14	89.4
Avg Max Error (mechanical degrees)	61.16	479.88	87.3	59.76	730.55	91.8	51.84	3.48e+2	85.1

Table 5-8. SpinTAC vs PI Position Control Disturbance Rejection Test Results (Estun Motor)

	750 rpm			1500 rpm			3000 rpm		
	SpinTAC	PI	SpinTAC Advantage (percentage improvement over PI)	SpinTAC	PI	SpinTAC Advantage (percentage improvement over PI)	SpinTAC	PI	SpinTAC Advantage (percentage improvement over PI)
25% rated torque									
Avg Recovery Time(s) - load applied	0.40	0.62	34.3	0.38	0.54	46.4	0.40	0.51	20.5
Avg Recovery Time(s) - load removed	0.22	0.3	24.8	0.18	0.29	34.0	0.20	0.33	39.5
Abs Avg Error (mechanical degrees)	9.21e-2	1.08	91.5	8.16e-2	1.01	90.6	8.36e-2	1.12	91.6
Avg Max Error (mechanical degrees)	2.63	2.85e+1	90.8	2.45	2.71e+1	90.9	2.27	4.1e+1	94.5
50% rated torque									
Avg Recovery Time(s) - load applied	0.29	0.46	36.2	0.24	0.42	43.0	0.27	0.35	21.7
Avg Recovery Time(s) - load removed	0.27	0.35	22.9	0.19	0.32	40.0	0.24	0.42	41.2
Abs Avg Error (mechanical degrees)	1.53e-1	1.73	91.1	1.58e-1	1.69	90.7	1.51e-1	1.41e+1	98.9
Avg Max Error (mechanical degrees)	3.35	5.64e+1	94.1	3.35	5.52e+1	93.9	3.53	5.38e+1	93.4
100% rated torque									
Avg Recovery Time(s) - load applied	0.58	0.76	23.0	0.54	0.78	30.9	0.46	5.00	90.7
Avg Recovery Time(s) - load removed	0.29	0.41	28.9	0.25	0.36	29.0	0.28	5.00	94.1
Abs Avg Error (mechanical degrees)	2.55	2.64e+1	89.9	2.08	2.67e+1	92.2	1.38	1.8e+3	99.9
Avg Max Error (mechanical degrees)	1.35e+2	1.24e+3	89.2	1.15e+2	1.23e+3	90.7	8.37e+1	1.8e+3	95.4

5.3.2 Reference Tracking

Reference tracking tests how well the controller follows a changing position target. The two metrics to evaluate in these tests are the maximum error and the absolute average error. The maximum position error shows how much the controller overshoots while changing speeds. This is an indication of how aggressively your controller is tuned. If your controller is not tuned aggressively enough, the speed will overshoot the target, and will take a long time to recover. If the controller is tuned too aggressively it will overshoot, and then oscillate as it settles on the position target. If the controller is correctly tuned, it will minimally overshoot and then smoothly return to the position target.

Absolute average error is an average of the absolute value of the instantaneous position error over the entire profile. This measure shows the amount of deviation throughout the entire profile. It takes into account all of the little errors as the motor is running. If the controller is tuned too aggressively it will result in larger absolute average error because the controller will be oscillating throughout the profile. If the controller is not tuned aggressively enough, it will result in a larger absolute average error because it is continuously falling behind the commanded profile.

A position tracking profile was created to exercise the motor in a repeatable pattern. The profile was used to compare the performance of SpinTAC Position Control and the PI control system. The profile included quick transitions as well as gentle sweeping transitions. [Figure 5-11](#) is a plot of the reference profile that was used in the tests.

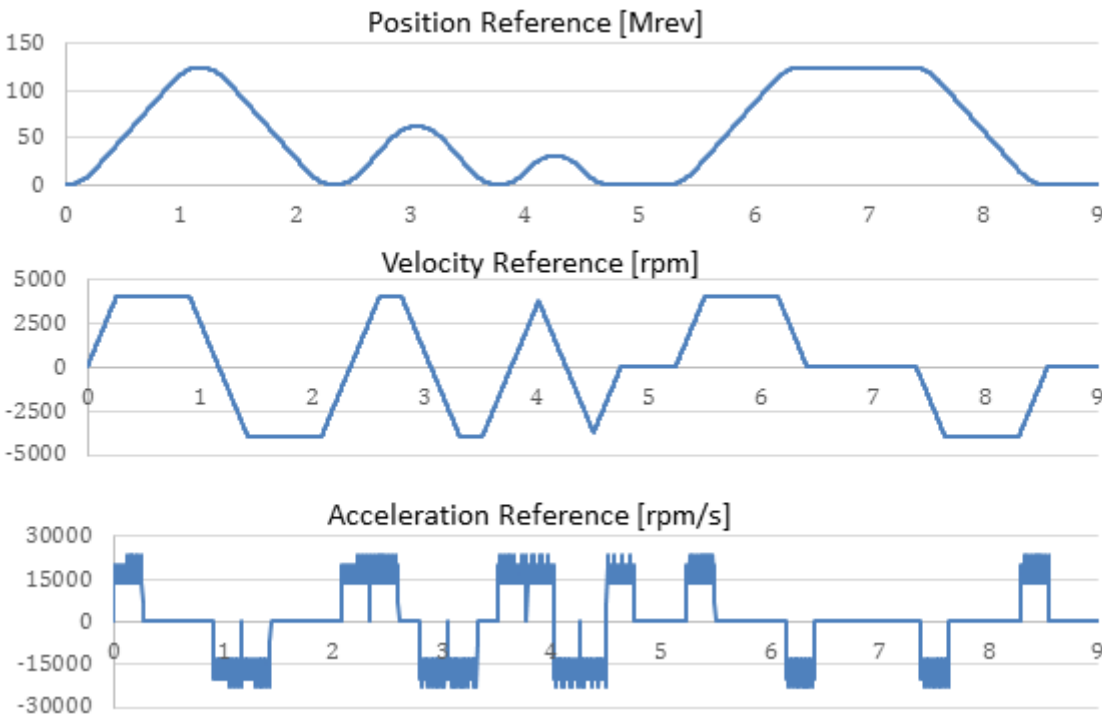

Figure 5-11. Position Profile Used During Reference Tracking Test

The blocked off area has an additional plot that will highlight the differences between SpinTAC and PI controllers.

[Figure 5-12](#) is the first part of the position reference tracking test. The red line at the bottom of the chart is the PI position error. The green line is the SpinTAC position error. Notice that the PI position error is much larger when making transitions and it also has an offset when in the constant velocity section of the profile. While SpinTAC has no issues with tracking the profile and has much less error than the PI controller.

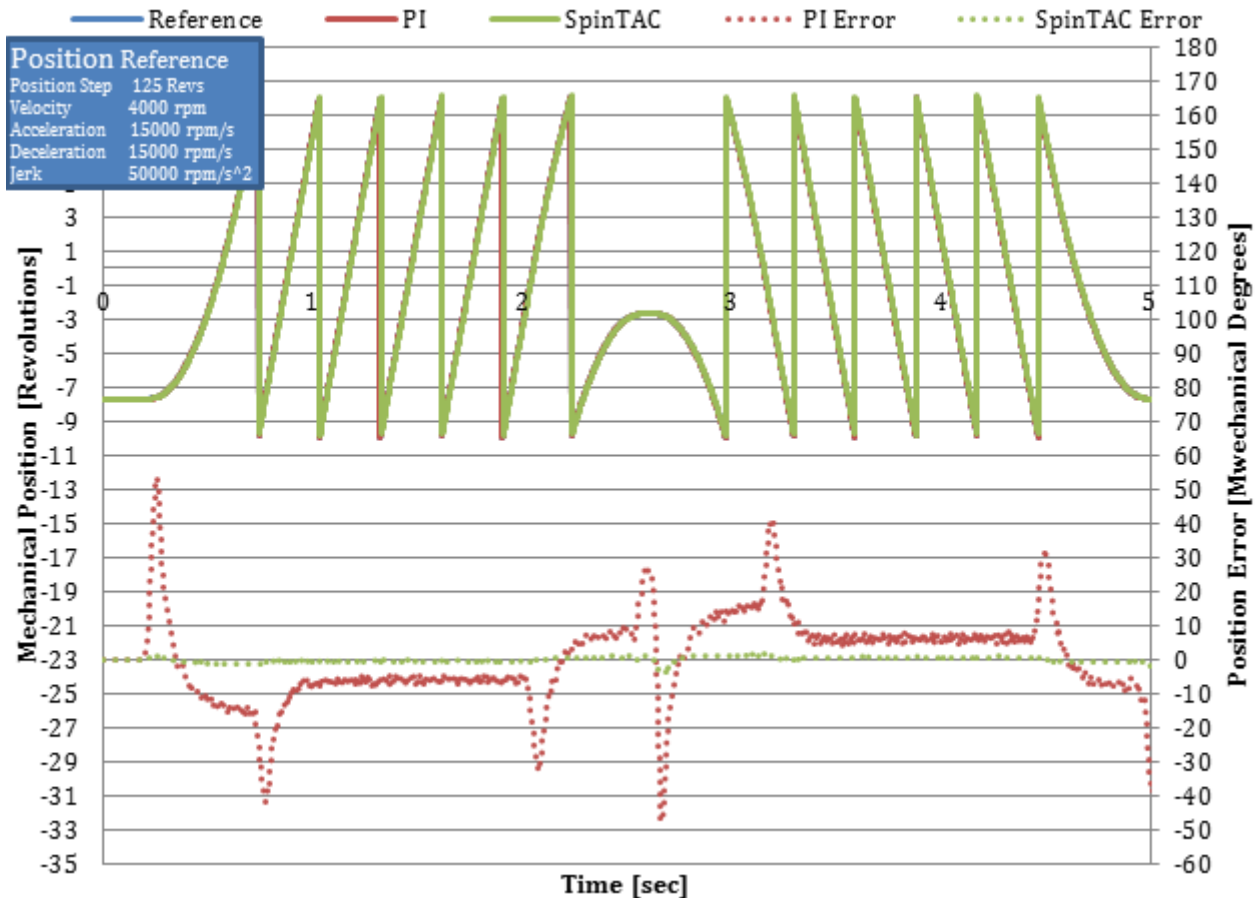

Figure 5-12. PI Error During Position Tracking

It is important to test multiple speeds and accelerations in your position profile as well as multiple different loads. Position controllers have different performance characteristics when placed into different situations. In order to properly evaluate the effectiveness of your controller, tests should be conducted across the entire application range. This includes when you design the profile for testing. Care needs to be taken to ensure that the application speeds and accelerations are built into the position profile. The results of these tests will indicate whether the controller will meet the application specifications, or if the controller needs to be tuned multiple times for different operating points. You should notice in [Figure 5-11](#) that there is a wide range of speeds and accelerations that are tested.

It is also important to be able to create repeatable profiles. Creating a repeatable profile can be done using SpinTAC Move and SpinTAC Plan (the [InstaSPIN-FOC and InstaSPIN-MOTION User's Guide](#) provides detailed information on SpinTAC Move and SpinTAC Plan, and lab projects are available in the [MotorWare](#) repository). Repeatable profiles are required if position controllers are being compared. A repeatable profile ensures that the controllers will be tested using the same reference in the same order and for the same length of time, and that test conditions are as identical as possible. The profile for this test was made using SpinTAC Move and SpinTAC Plan.

The following parameters were measured:

- Absolute Average Position Error - deviation (in mechanical degrees) from the target over the entire position profile.
- Maximum Position Error - maximum deviation (in mechanical degrees) from the goal position during the position profile.

Table 5-9. SpinTAC vs PI Position Profile Tracking Test Results

	Trapezoidal Curve			st-Curve		
	SpinTAC	PI	SpinTAC Advantage (percentage improvement over PI)	SpinTAC	PI	SpinTAC Advantage (percentage improvement over PI)
Teknic Motor						
Abs Avg Error (mechanical degrees)	3.6e-1	5.98	94.0	3.95e-1	4.54	91.5
Max Error (mechanical degrees)	3.85	95.8	96.0	4.03	53089	92.5
Estun Motor						
Abs Avg Error (mechanical degrees)	3.32e-1	10.19	96.7	3.48e-1	51.05	99.3
Max Error (mechanical degrees)	2.12	126.75	98.3	1.76	113.55	98.4

5.3.3 Step Response

The step tests for a position controller provide giving a step input to the controller to determine how quickly the controller can respond to a sudden input change. The two metrics evaluated during these tests are settling time and maximum overshoot. This test is also a measure of stability of your controller. If the controller oscillates upon reaching the goal speed then it is not very stable.

A step profile was applied to SpinTAC Position Control and the PI control system. This step input bypassed the profile generator. The following parameters were measured:

- Settling Time (from the step input until within 2% of the target position) - the settling time reflects how long it takes the controller to reach the goal position.
- Maximum Overshoot - maximum mechanical degrees measured after the step input.

[Figure 5-13](#) compares the step responses of SpinTAC Position Control and the PI control system. It also provides a visual representation showing how these metrics were calculated. SpinTAC Position Control was able to reach the goal position with zero overshoot and a shorter settling time than the PI control system.

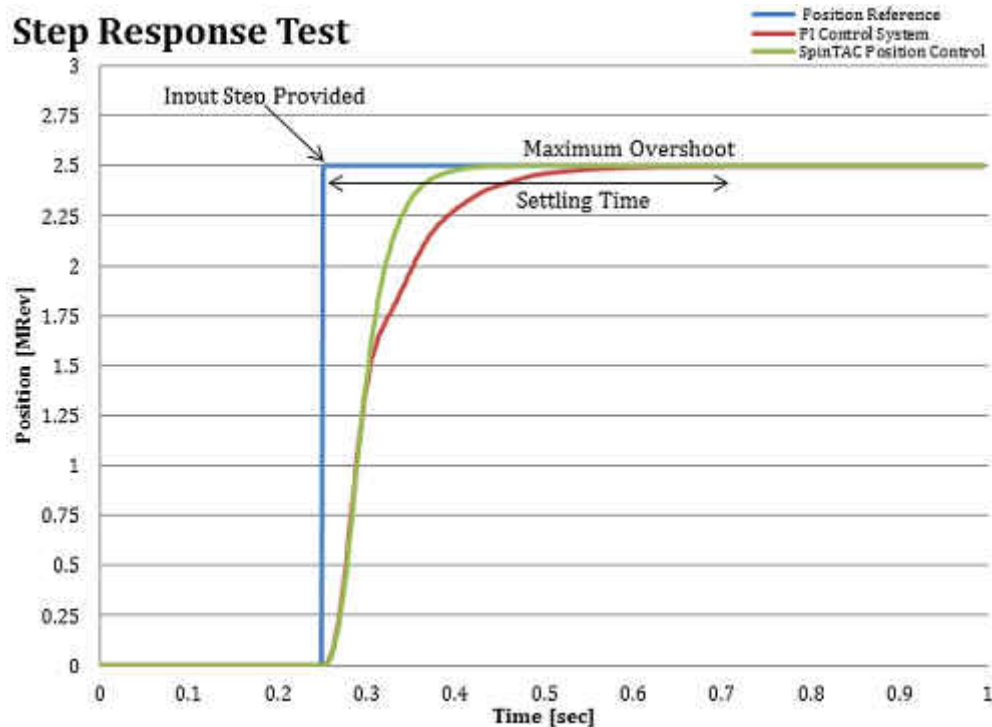

Figure 5-13. Step Response Test of Maximum Overshoot and Settling Time

Table 5-10. SpinTAC vs PI Position Control Step Response Test Results (Teknic Motor)

	Settling Time(s)			Overshoot (mechanical degrees)		
	SpinTAC	PI	SpinTAC Advantage (percentage improvement over PI)	SpinTAC	PI	SpinTAC Advantage (percentage improvement over PI)
0-4.9 mechanical degrees						
	0.23	0.54	57.4	0.00	0.00	0.0
	0.22	0.45	51.1	0.00	0.00	0.0
	0.25	0.46	45.7	0.00	0.00	0.0
	0.28	0.45	37.8	0.00	0.00	0.0
	0.27	0.43	37.2	0.00	0.00	0.0
0-2.5 mechanical degrees						
	0.24	0.36	34.4	0.00	0.00	0.0
	0.23	0.38	39.5	0.00	0.00	0.0
	0.24	0.41	41.5	0.00	0.00	0.0
	0.23	0.40	42.5	0.00	0.00	0.0
	0.21	0.41	48.8	0.00	0.00	0.0
0-1.25 mechanical degrees						
	0.21	0.41	48.5	0.00	0.00	0.0
	0.20	0.41	51.2	0.00	0.00	0.0
	0.18	0.46	60.9	0.00	0.00	0.0
	0.18	0.40	55.0	0.00	0.00	0.0
	0.23	0.38	39.5	0.00	0.00	0.0

Table 5-11. SpinTac vs PI Position Control Step Response Test Results (Estun Motor)

	Settling Time(s)			Overshoot (mechanical degrees)		
	SpinTAC	PI	SpinTAC Advantage (percentage improvement over PI)	SpinTAC	PI	SpinTAC Advantage (percentage improvement over PI)
0-4.9 mechanical degrees						
	0.67	0.59	-13.6	4.54e+2	1.26e+3	63.9
	0.94	0.57	-66.1	4.57e+2	1.26e+3	63.7
	0.86	0.57	-49.6	4.58e+2	1.27e+3	63.8
	0.70	0.60	-15.5	4.58e+2	1.27e+3	63.8
	0.81	0.62	-30.1	4.58e+2	1.28e+3	64.3
0-2.5 mechanical degrees						
	0.53	0.50	-5.8	8.14e+1	4.03e+2	79.8
	0.52	0.48	-8.3	8.14e+1	4.18e+2	80.5
	0.62	0.49	-27.2	8.17e+1	4.10e+2	80.1
	0.56	0.47	-18.2	8.17e+1	4.18e+2	80.5
	0.17	0.49	65.2	8.14e+1	3.70e+2	78.0
0-1.25 mechanical degrees						
	0.53	0.42	-26.2	0.00	1.69e+1	100
	0.53	0.32	-65.6	0.00	1.44e+1	100
	0.53	0.33	-63.1	0.00	1.69e+1	100
	0.53	0.41	-30.6	0.00	1.63e+1	100
	0.60	0.36	-68.4	0.00	1.63e+1	100

5.3.4 Inertia Estimation Repeatability

The system inertia is an important input into both SpinTAC Velocity Control and SpinTAC Position Control. The inertia value is estimated using SpinTAC Velocity Identify. SpinTAC Velocity Identify produces a very accurate inertia estimation. In order to test the repeatability of SpinTAC Velocity Identify, the inertia identification process was ran 100 times for each motor. The results are collected in [Figure 5-14](#) and [Figure 5-15](#).

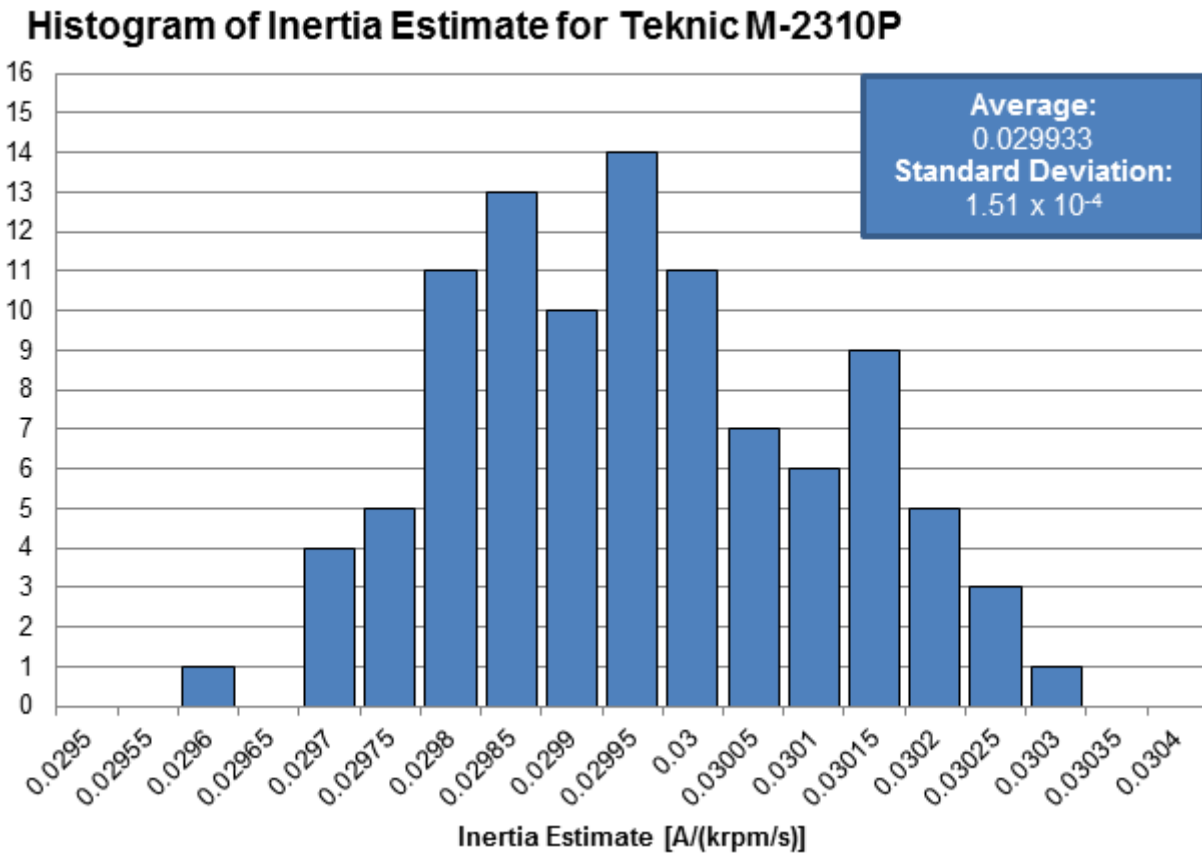

Figure 5-14. Inertia Estimation Results for Teknic M-2310P

Histogram of Inertia Estimate for Estun EMJ-04APB22

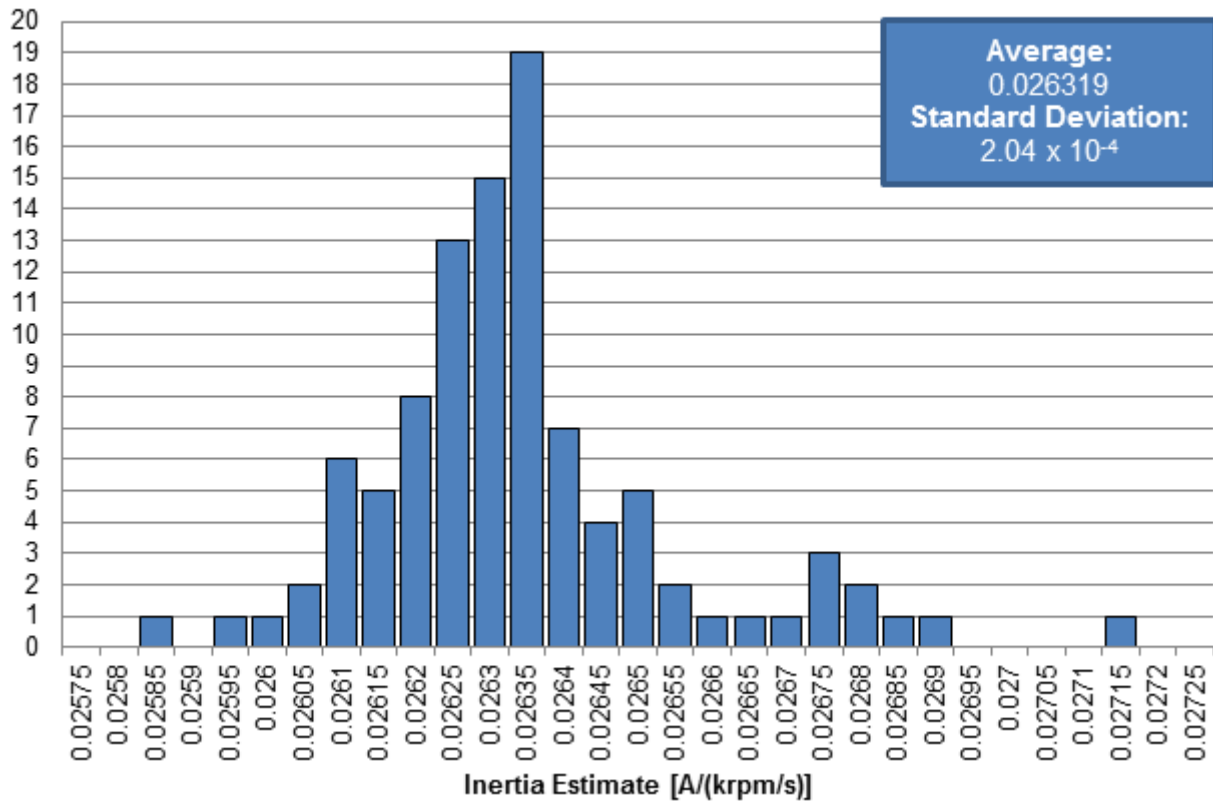

Figure 5-15. Inertia Estimation Results for Estun EMJ-04APB22

From the above results, it is clear that SpinTAC Velocity Identify has a very high degree of repeatability. It is not required that the inertia estimation that is provided to the SpinTAC controller be the perfect inertia value. As a robustness feature, a SpinTAC speed controller can accept a wide range of inertia changes. However, the SpinTAC speed controller will always produce the best performance if the inertia value provided to it is accurate.

This page intentionally left blank.

The TMS320F2805xM microcontroller resources required by the InstaSPIN libraries are discussed in detail in the [InstaSPIN-FOC and InstaSPIN-MOTION User's Guide](#).

The following resources were measured to determine their consumption by the InstaSPIN-MOTION library:

- CPU Utilization
- Memory Allocation
- Stack Utilization
- Digital and Analog Pins Utilization

6.1 CPU Utilization.....	54
6.2 Memory Utilization.....	57
6.3 Security Zones.....	59
6.4 Linker Command File Settings.....	59
6.5 Interfacing FAST ROM Libraries.....	59
6.6 Pin Utilization.....	60
6.7 Consideration of Analog Front-End (AFE) Module.....	60

6.1 CPU Utilization

Figure 6-1 illustrates the options available to the designer to manage the real-time scheduling of each of the major software functions.

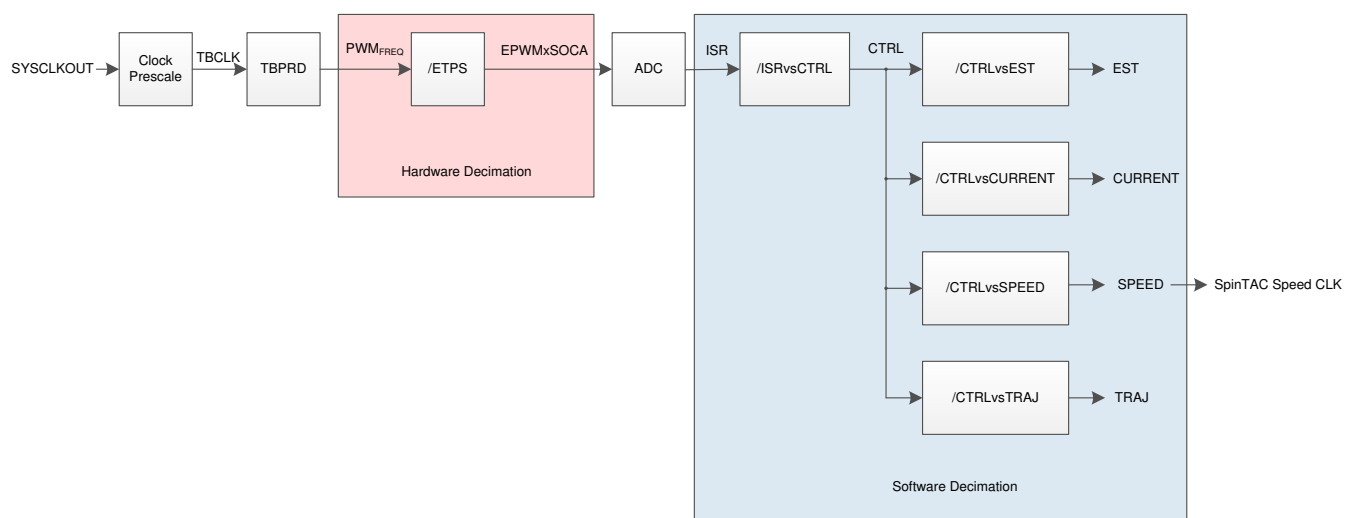

Figure 6-1. Software Execution Clock Tree Provides Flexibility with Real-Time Scheduling

Table 6-1 indicates CPU cycle utilization of SpinTAC components running out of ROM on the 28054M and 28052M devices. Note that this data is for the SpinTAC components only, and does not include InstaSPIN-FOC. For InstaSPIN-FOC CPU utilization and memory footprints, see the [TMS320F2805xF InstaSPIN-FOC™ Software Technical Reference Manual](#).

The Speed Count is used to calculate the SpinTAC sample time. SpinTAC is called from main ISR but can be decimated using the same decimation rate used to run the speed controller. The correct decimation rate can be calculated by multiplying the USER_NUM_ISR_TICKS_PER_CTRL_TICK by the USER_NUM_CTRL_TICKS_PER_SPEED_TICK.

Table 6-1. SpinTAC CPU Cycle Utilization with Library Executing in Flash

Function Name ^{(1) (2)}	CPU Cycles ^{(3) (4)}			Executed From		
	Min	Avg	Max	ROM	RAM	FLASH
STVELCTL_run (Velocity Control)						
RES = 1, ENB = 0	189	189	189			
RES = 0, ENB = 1	614	614	614			
First call after ENB = 1	1077	1077	1077	✓	×	✓
Change Bandwidth	842	842	842			
Change Inertia parameter	842	842	842			
RES = 1, ENB = 1	347	347	347			
STVELMOVE_run (Velocity Move)						
RES = 1, ENB = 0	220	220	220			
stcurve RES = 0, ENB = 1	724	759	1468			
scurve RES = 0, ENB = 1	687	724	1435	✓	×	✓
trap RES = 0, ENB = 1	561	636	1167			
RES = 1, ENB = 1	494	494	494			
STVELPLAN_run (Velocity Plan)						
RES = 1, ENB = 0	183	183	183			
RES = 0, ENB = 1	238	238	238			
First call after ENB = 1	333	333	333			
STAY FSM State	238	238	238			
Transition FSM State Calculation must be done for each State	436 (fixed) + 320 * Number of Transitions + 388 * Number of EXIT Actions			✓	×	✓
Condition FSM State Calculation must be done for each State	283 (fixed) + 438 * Number of ENTER Actions					
STVELPLAN_runTick (ISR function)	76	100	100			
STVELID_run (Velocity Identify)						
RES = 1, ENB = 0	198	198	198			
RES = 0, ENB = 1	256	278	723	✓	×	✓
First call after ENB = 1	1196	1196	1196			
RES = 1, ENB = 1	292	292	292			
STPOSCOV_run (Position Converter)						
RES = 1, ENB = 0	127	127	127			
RES = 0, ENB = 1	391	398	400	✓	×	✓
First call after ENB = 1	1209	1209	1209			
RES = 1, ENB = 1	140	140	140			
STPOSCTL_run (Position Control)						
RES = 0, ENB = 0	201	201	201			
RES = 0, ENB = 1	1207	1212	1225			
First call after ENB = 1	2043	2043	2043	✓	×	✓
Change Bandwidth parameter	1729	1729	1729			
Change Inertia parameter	1729	1729	1729			
RES = 1, ENB = 1	449	449	449			

Table 6-1. SpinTAC CPU Cycle Utilization with Library Executing in Flash (continued)

Function Name ^{(1) (2)}	CPU Cycles ^{(3) (4)}			Executed From		
	Min	Avg	Max	ROM	RAM	FLASH
STPOSMOVE_run (Position Move)						
RES = 0, ENB = 0	520	520	520			
stcurve RES = 0, ENB = 1	790	1611	3630			
Velocity Controlled Profile	1467	1588	2778			
scurve RES = 0, ENB = 1	790	1564	3205	✓	×	✓
Velocity Controlled Profile	1415	1551	2734			
trap RES = 0, ENB = 1	790	1501	3130			
Velocity Controlled Profile	1540	1903	2438			
RES = 1, ENB = 1	996	996	996			
STPOSPLAN_run (Position Plan)						
RES = 1, ENB = 0	202	202	20			
RES = 0, ENB = 1	255	255	255			
First call after ENB = 1	373	373	373			
STAY FSM State	255	255	255			
Condition FSM State Calculation must be done for each State	501 (fixed) + 323 * Number of Transitions + 382 * Number of EXIT Actions			✓	×	✓
Transition FSM State Calculation must be done for each State	301 (fixed) + 432 * Number of ENTER Actions					
STPOSPLAN_runTick (ISR function)	86	115	115			

- (1) RES = 1 indicates that the component is in Reset.
 (2) ENB = 1 indicates that the component is enabled.
 (3) Microcontrollers were run at 60 MHz with the PWM at 15 kHz.
 (4) The typical state appears in **bold**.

6.2 Memory Utilization

Table 6-2 lists the memory usage for each SpinTAC component. In SpinTAC Plan, there are a large number of configuration functions.

Table 6-2. Code Size and RAM Usage for SpinTAC Components

Component	Code (.text) (16-bit Words)	RAM (.ebss) (16-bit Words)
Velocity Control	0x2E6	0x4C
Velocity Move	0x488	0x5C
Velocity Plan (Minimum)	0x666	0x4E
Velocity Plan (Maximum)	0x14BA	0x4E
Velocity Identify	0x392	0x3C
Position Converter	0x21C	0x4C
Position Control	0x416	0x62
Position Move	0x13A4	0xCC
Position Plan (Minimum)	0x7AE	0x60
Position Plan (Maximum)	0x16F4	0x60

Table 6-3 breaks down the maximum stack utilization of SpinTAC components when run individually. The stack consumption of InstaSPIN-FOC is included. To calculate the stack usage, the entire memory section where the stack is placed is filled with known values. The corresponding code was then run for a few minutes. The memory area where the stack was allocated was analyzed and the amount of used memory was calculated.

Table 6-3. Stack Utilization of SpinTAC Components + InstaSPIN-FOC

Configuration	Maximum Stack Used (16-bit Words)
Velocity Control	0x0120
Velocity Move	0x0120
Velocity Plan + Move + Control	0x0120
Velocity Identify	0x0120
Position Converter	0x0120
Position Control	0x0120
Position Move	0x0120
Position Plan + Move + Control	0x0120

Table 6-4 shows the allocated memory for the InstaSPIN-FOC and SpinTAC library.

Table 6-4. 2805xF and 2805xM Allocated Memory for InstaSPIN-FOC and SpinTAC Library

Features	2806xF	2806xM	2805xF	2805xM	2802xF
FAST	Yes	Yes	Yes	Yes	Yes
SpinTAC	No	Yes	No	Yes	No
Maximum Number of Motors that can be controlled	2	2	2	2	1
Relocalable Controller Structure	No	No	Yes	Yes	Yes
FAST Version	1.6	1.6	1.7	1.7	1.7
Public Library needs to be added to project	No	No	No	No	Yes
ROM Library [size, hex, words]	4000	4000	3D27	3D27	2000
ROM Library Start [address, hex]	3F 8000	3F 8000	3F 8808	3F 8808	3F C000
Library Required RAM [size, hex, words]	800	800	800	800	200
Library Start RAM [address, hex]	01 3800	01 3800	00 8000	00 8000	00 0600

For the F2805xM device, FAST v1.7 and SpinTAC v2.2.7 are stored in execute-only memory. Figure 6-2 shows the memory map for these devices, highlighting locations that have been assigned for FAST and SpinTAC.

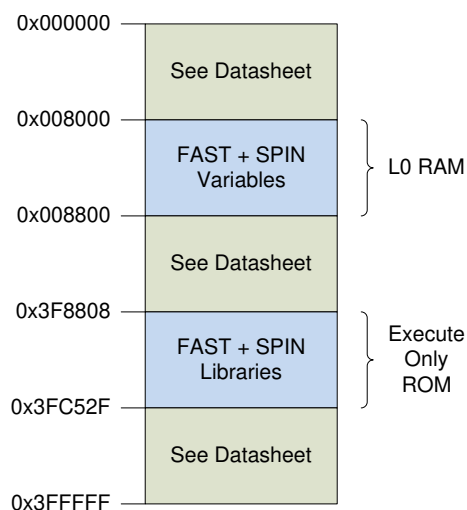

Figure 6-2. F2805xF and F2805xM Allocated Memory for InstaSPIN-FOC and SpinTAC Library

This variant of the library requires the addition of a control structure to the project, which will be loaded to user's RAM space. The control structure is public and contains no specific information about the estimator, but it is needed to allow the library interface to work. The control structure can be declared as a single item, or can be declared as an array of two for user's controlling two motors independently.

```
// control structure declaration in main.c to control one motor
CTRL_Obj ctrl;
// control structure declaration in main.c to control two motors
CTRL_Obj ctrl[2];
```

Each ctrl member consumes 0x100 x 16-bit words, or 512 Bytes of memory. The specific location of ctrl or ctrl[2] structures is not important, so users can store these structures anywhere in volatile memory.

6.3 Security Zones

The F2805xM devices offer different security zones, selectable by the user. Keep in mind that the security zone configuration might affect the operation of the interface to the library. For example, if the memory area where the controller object is placed is secured, then libraries in ROM would not be able to write to this memory; therefore, not updating the controller object properly. For more details, see the security section of the [TMS320F2805x Real-Time Microcontrollers Data Sheet](#).

The libraries in ROM, as well as the RAM, that are pre-allocated for the estimator are in the Z1 section. Make sure that the RAM utilized to place the variables used to interface with the library are accessible by the Z1 security zone.

6.4 Linker Command File Settings

In order for the 2805xM devices to use InstaSPIN, the volatile memory area used by the libraries in ROM must be reserved. The following code listing of the RAM area shows that L0 RAM should not be used. To avoid conflicts between user's memory and library used memory, variables declared by the user must not use this memory range.

```

RAMM0      : origin = 0x000050, length = 0x0003B0
//RAML0    : origin = 0x008000, length = 0x000800
RAML1     : origin = 0x008800, length = 0x000800
RAML2     : origin = 0x009000, length = 0x000800
RAML3     : origin = 0x009800, length = 0x000800
    
```

6.5 Interfacing FAST ROM Libraries

In order to interface the ROM libraries, the user needs to include a library in their project. This library contains the symbolic addresses to the software in ROM. The following is the relative MotorWare path to the symbols library for this particular family.

```
sw\modules\fast\lib\32b\f28x\f2805x
```

As can be seen in the project screen capture shown in [Figure 6-3](#), a symbols-only library was linked in the project.

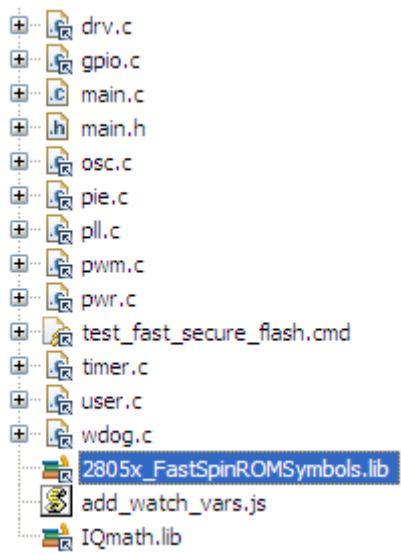

Figure 6-3. 2805x Project with ROM Symbols Library

The same estimator header files are needed as shown for the 2805x device variant (est.h, est_Flux.h, est_Ls.h, est_Rs.h).

Also, as explained for the F2805x device variant, some of the functions of the controller object (CTRL_Obj) are also included in ROM. The following relative path is an example of a controller header file path for one of the boards TI offers:

```
sw\solutions\instaspin_foc\boards\hvkit_rev1p1\f28x\f2805x\src\ctrl.h
```

6.6 Pin Utilization

Flexibility in the design of InstaSPIN-FOC allows for multiple motors to be supported. [Table 6-5](#) lists the minimum and maximum pins used per motor. Note that a F2805xM microcontroller provides (14) ePWM outputs with the 80-pin package.

Table 6-5. Pin Utilization Per Motor

Pin Type	Pin Name	Pins Usage Per Motor	
		Minimum	Maximum
Digital	PWM1A	3 (Requires External Fault and External Complementary Mode with Dead Time)	7
	PWM1B (Optional)		
	PWM2A		
	PWM2B (Optional)		
	PWM3A		
	PWM3B (Optional)		
	Trip Zone (Optional)		
Analog	IA	5 (Only two currents and no VBUS ripple compensation)	7
	IB		
	IC (Optional)		
	VA		
	VB		
	VC		
	VBUS (Optional)		

6.7 Consideration of Analog Front-End (AFE) Module

In InstaSPIN applications, motor line current and phase voltage are required by the algorithm. Before these analog signals are sampled by the processor, all signals are processed by an analog circuit. The external analog circuits add component cost and increase board size. The 2805x series of processors addresses this issue by adding internal analog conditioning components for the motor feedback signals, called the analog front end (AFE).

For more detailed information about the 2805x device, see the [TMS320F2805x Real-Time Microcontrollers Technical Reference Manual](#).

6.7.1 Routing Current Signals

Before addressing about the implementation and usage of the PGAs and comparators, it is recommended to consider how current feedback signals are routed from the shunt and then to the input of the PGA. When a shunt resistor is used to measure line current, its value must be small to reduce the amount of power dissipated in the shunt. Because the value is small, so is the resulting voltage drop across the shunt. There is a significant amount of current flowing through the shunt resistors. Copper traces that connect the shunts from the bottom of the power device and then to ground become a resistor in series with the shunt. The parasitic resistance that forms on the copper trace must be taken into consideration when measuring motor line currents with a shunt resistor.

The AFE can have up to three different grounds. The 2805x device has multiple groups of amplifier blocks. Each group of amplifiers has a different ground. M1 ground is used for the group of three PGAs that will feedback three-phase motor currents for this document. For systems with power factor correction, there is another single PGA and its ground is PFC ground. The fixed-gain amplifier block uses M2 ground for its reference and is used in this document for three motor voltage feedbacks.

Two options for the feedback of motor shunt current signals to the M1 PGA block of the AFE are discussed. The first option is to use only the internal op-amps for the current feedback as shown in Figure 6-4. All three op-amps share the same ground for the inverting input and therefore a differential signal of the shunt current cannot be created. With single-ended signals, careful layout must be done when grounding the shunts to reduce the amount of differing trace resistance between shunts. It is advised to have the shunt grounds as close together as possible. A trace must run from the point that the shunts come together to the M1gnd pin of the integrated circuit. Because common mode noise can be added to the amplifier, the M1gnd pin and PGA inputs must be made as short as possible. The three phase current traces must be routed as close to the M1gnd trace as possible to reduce the size of the Faraday loop. The Faraday loop is created around the phase current trace that starts from the top of the shunt to the IC and then back on the M1gnd trace to the bottom of the shunt, through the shunt and back to the top of the shunt.

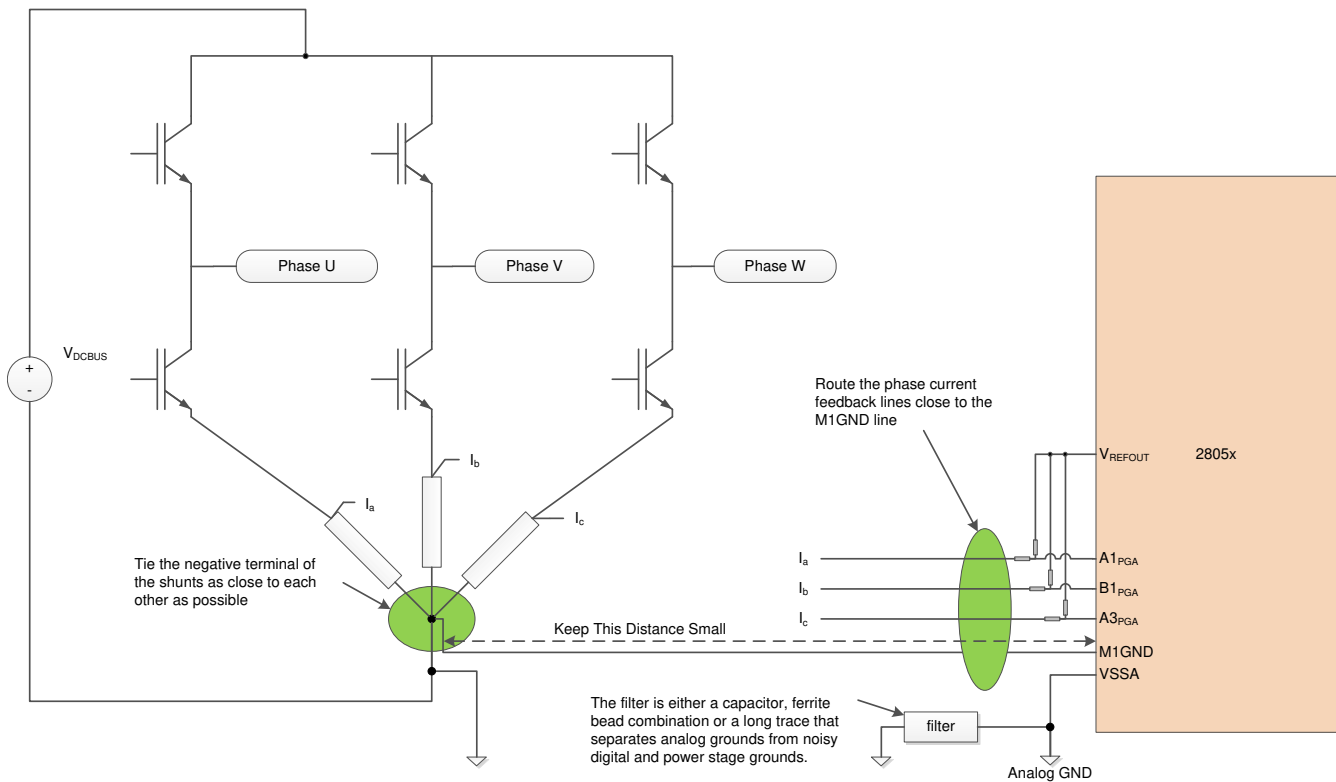

Figure 6-4. Current Signal Routing Directly to PGAs With Single-Ended Connections

The second, and most noise immune option, is to use external op-amps in a differential amplifier configuration. A true Kelvin connection can feedback directly to the differential amplifier, and then the output of the differential amplifier is sent into the PGA input. Figure 6-5 shows a typical layout when using external differential op-amps. Since the Kelvin connection has low impedance and is a truly differential signal, it provides excellent noise immunity. The external op-amp circuit converts the differential circuit into a single-ended output. The single-ended output is more susceptible to noise and therefore it is best to place the output of the op-amp as close to the AFE input of the processor.

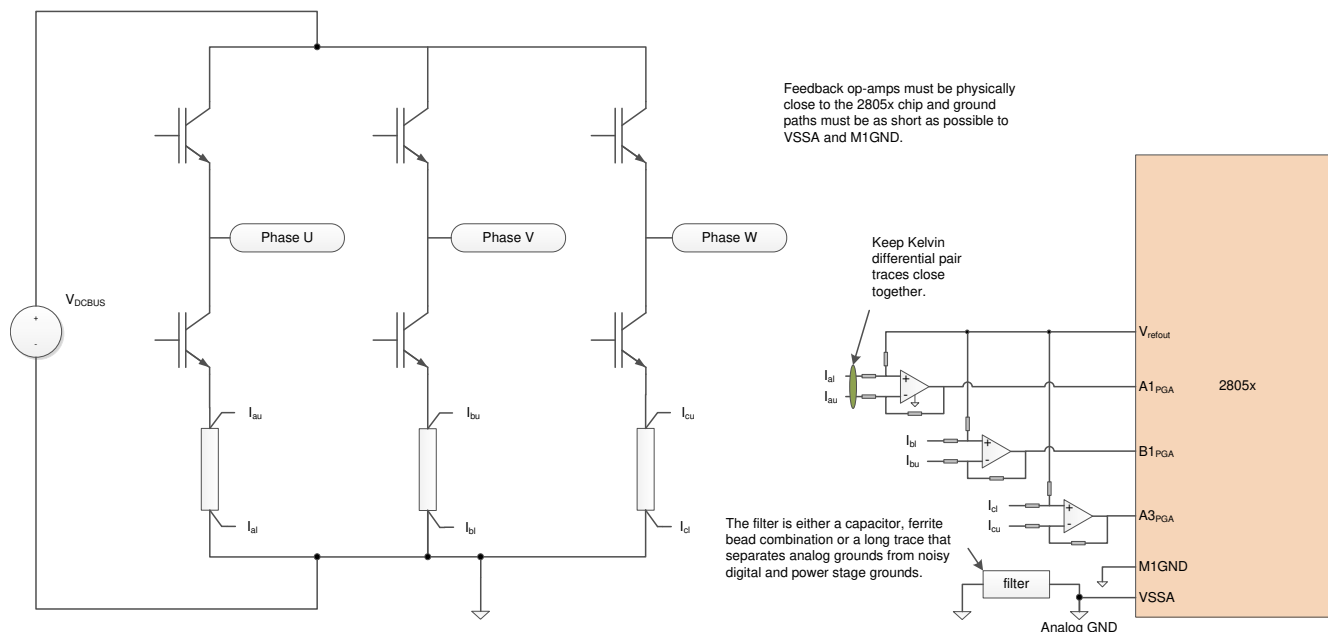

Figure 6-5. Feedback of Phase Currents Using External Differential Amplifiers

Why use the PGAs when external amplifiers are already being used? One case would be if many different current rated motors are powered with the same inverter. Amplification of the current signal can be adjusted to best suit the motor size that is controlled. The output of the PGA block is the input of the comparator windows. The PGA still needs to be connected to enable the use of the fault detection circuitry.

6.7.2 Voltage Reference Connection

Current can flow through the shunt in both positive and negative directions which will create both a positive and negative voltage that is fed back to the shunt amplifier circuit. Most cost-effective motor inverters do not have both positive and negative power supplies that can handle this bipolar signal. A bipolar current signal is brought into an amplifier that will only be effective from zero to the positive voltage supply. To allow the unipolar op-amp circuit to measure a bipolar signal, a voltage reference is summed into the non-inverting side of the current feedback op-amps. The AFE of the 2805x device contains a 6-bit DAC with a voltage follower for providing an output reference for this reason. A circuit configuration that can use a voltage reference to measure the bipolar current signal is shown in Figure 6-6.

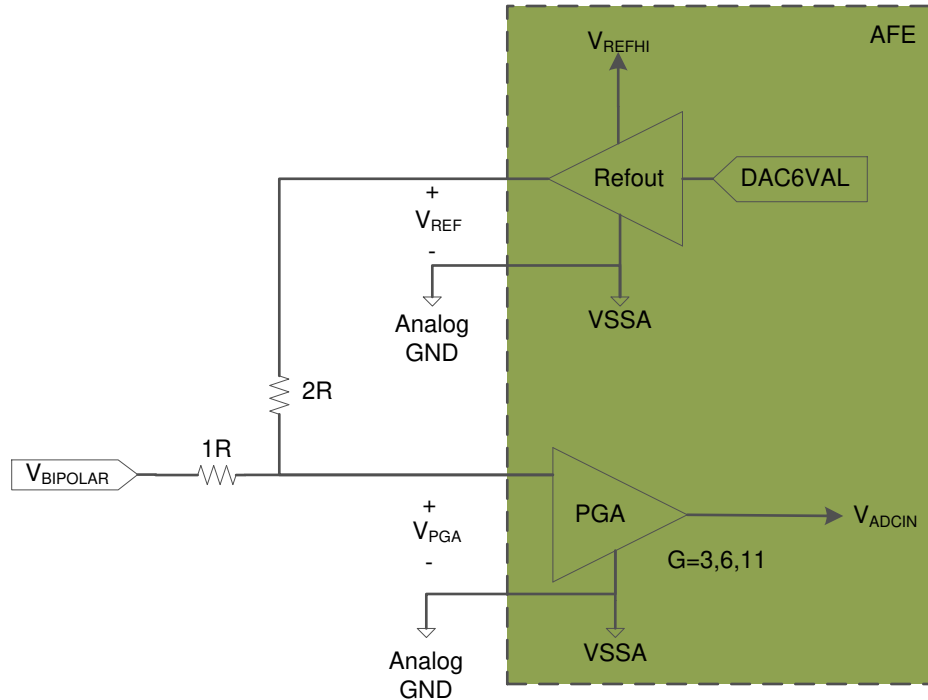

Figure 6-6. Using the AFE's Built-In Voltage Reference For Measuring a Bipolar Signal

Equation 1 shows how to calculate the voltage at V_{PGA} . As an example, set the PGA gain = 3. V_{ADCIN} will be $2V_{BIPOLAR} + V_{REF}$. Assume the system's V_{REFHI} is 3.3 V. To allow for maximum voltage swing in both directions, V_{REF} is set to 1.65 V. Now the maximum peak $V_{BIPOLAR}$ voltage that can be measure is ± 0.825 V.

$$V_{PGA} = \frac{2R \cdot (V_{BIPOLAR} - V_{REF})}{(1R + 2R)} + V_{REF} = \frac{2}{3} V_{BIPOLAR} + \frac{1}{3} V_{REF} \quad (1)$$

Suppose the same hardware is used and a higher resolution is required. The PGA gain = 6. V_{ADCIN} is $4V_{BIPOLAR} + 2V_{REF}$. V_{REF} must be adjusted to be 0.825 V. The maximum peak $V_{BIPOLAR}$ voltage that can be measured is ± 0.4125 V.

The voltage reference output is adjusted by a 6-bit DAC. The VREFOUTCTL register controls the DAC's voltage output by Equation 2.

$$V_{REF} = \frac{V_{REFHI} \cdot (VREFOUTCTL_{DACVAL} + 1)}{64} \quad (2)$$

6.7.3 Routing Voltage Signals

In sinusoidal motor control drives, the voltage signals vary slowly when compared to current signals. Therefore, larger hardware filters can be applied to the voltage feedback signal which helps to make it less susceptible to noise. Voltage signals are unipolar, so no special circuit and reference have to be used. Lower voltage motors (under 400 V_{DCBUS}) typically only require resistor dividers with a capacitive low-pass filter. For a brushless DC motor control the voltage needs as little phase shift as possible and, therefore, the low-pass filtering depends on the maximum speed achieved by the motor. The only critical layout of voltage feedback signals is that the low-pass filter capacitor must be located as close to the AFE or A/D input pin as possible.

This page intentionally left blank.

To get started using InstaSPIN software in your own application:

- Order the [evaluation kit](#) that matches your motor.
- Download the [MotorWare](#) software (all of the labs and the lab manual are available in the MotorWare repository)
- Download [Code Composer Studio™](#) integrated development environment (IDE) v5.5 or later.

If you have questions, post them to the [TI E2E™ Online Community InstaSpin Motor Solutions Forum](#).

This page intentionally left blank.

ACIM	Alternating current induction motor.
ADRC	Active Disturbance Rejection Control. Estimates and compensates for system disturbance, in real-time.
CCStudio	Code Composer Studio™ IDE
FAST™	<p>Unified observer structure which exploits the similarities between all motors that use magnetic flux for energy transduction, automatically identifying required motor parameters and providing the following motor feedback signals:</p> <ul style="list-style-type: none"> • High-quality Flux signal for stable flux monitoring and field weakening. • Superior rotor flux Angle estimation accuracy over wider speed range compared to traditional observer techniques independent of all rotor parameters for ACIM. • Real-time low-noise motor shaft Speed signal. • Accurate high bandwidth Torque signal for load monitoring and imbalance detection.
FOC	Field-oriented control.
Forced-Angle	Used for 100% torque at start-up until the FAST rotor flux angle tracker converges within first electrical cycle.
InstaSPIN-FOC™	Complete sensorless FOC solution provided by TI on-chip in ROM on select devices (FAST observer, FOC, speed and current loops), efficiently controlling your motor without the use of any mechanical rotor sensors.
InstaSPIN-MOTION™	A comprehensive motor-, motion- and speed-control software solution that delivers robust system performance at the highest efficiency for motor applications that operate in various motion state transitions. InstaSPIN-MOTION builds on and includes InstaSPIN-FOC, combined with SpinTAC™ Motion Control Suite from LineStream Technologies.
IPM	Interior permanent magnet motor.
LineStream Technologies	Pioneers in the world of embedded controls software. Boasting a team of motor control experts from six different countries cumulatively speaking fifteen languages and possessing over eighty years of industry experience, LineStream is fast becoming the world's preeminent stronghold of embedded motor control knowledge.
Motor Parameters ID or Motor Identification	A feature added to InstaSPIN-FOC, providing a tool to the user so that there is no barrier between running a motor to its highest performance even though the motor parameters are unknown.
PI	Proportional-integral regulator.

PMSM	Permanent magnet synchronous motor.
PowerWarp™	A mode of operation for AC induction motors (ACIM) that minimizes motor losses under lightly loaded conditions.
Rs-Offline Recalibration	InstaSPIN-FOC feature that is used to recalibrate the stator resistance, R_s , when the motor is not running.
Rs-Online Recalibration	InstaSPIN-FOC feature that is used to recalibrate the stator resistance, R_s , while the motor is running in closed loop.
SpinTAC™ Motion Control Suite	Includes an advanced speed controller, a motion engine, and a motion sequence planner. The SpinTAC disturbance-rejecting speed controller proactively estimates and compensates for system disturbances in real-time, improving overall product performance. The SpinTAC motion engine calculates the ideal reference signal (with feed forward) based on user-defined parameters. SpinTAC supports standard industry curves, and LineStream's proprietary "smooth trajectory" curve. The SpinTAC motion sequence planner operates user-defined state transition maps, making it easy to design complex motion sequences.
SVM	Space-vector modulation.

Changes from Revision (March 2014) to Revision A (October 2021)	Page
• Added Chapter Read This First	5
• Changed Chapter 1	7

This page intentionally left blank.

IMPORTANT NOTICE AND DISCLAIMER

TI PROVIDES TECHNICAL AND RELIABILITY DATA (INCLUDING DATA SHEETS), DESIGN RESOURCES (INCLUDING REFERENCE DESIGNS), APPLICATION OR OTHER DESIGN ADVICE, WEB TOOLS, SAFETY INFORMATION, AND OTHER RESOURCES "AS IS" AND WITH ALL FAULTS, AND DISCLAIMS ALL WARRANTIES, EXPRESS AND IMPLIED, INCLUDING WITHOUT LIMITATION ANY IMPLIED WARRANTIES OF MERCHANTABILITY, FITNESS FOR A PARTICULAR PURPOSE OR NON-INFRINGEMENT OF THIRD PARTY INTELLECTUAL PROPERTY RIGHTS.

These resources are intended for skilled developers designing with TI products. You are solely responsible for (1) selecting the appropriate TI products for your application, (2) designing, validating and testing your application, and (3) ensuring your application meets applicable standards, and any other safety, security, regulatory or other requirements.

These resources are subject to change without notice. TI grants you permission to use these resources only for development of an application that uses the TI products described in the resource. Other reproduction and display of these resources is prohibited. No license is granted to any other TI intellectual property right or to any third party intellectual property right. TI disclaims responsibility for, and you will fully indemnify TI and its representatives against, any claims, damages, costs, losses, and liabilities arising out of your use of these resources.

TI's products are provided subject to [TI's Terms of Sale](#) or other applicable terms available either on ti.com or provided in conjunction with such TI products. TI's provision of these resources does not expand or otherwise alter TI's applicable warranties or warranty disclaimers for TI products.

TI objects to and rejects any additional or different terms you may have proposed.

Mailing Address: Texas Instruments, Post Office Box 655303, Dallas, Texas 75265
Copyright © 2022, Texas Instruments Incorporated