

UCC27212A-Q1 Automotive 120V, 3.7A/4.5A Half-Bridge Driver with 5V UVLO

1 Features

- AEC-Q100 qualified for automotive applications: device temperature grade 1
- -40°C to $+150^{\circ}\text{C}$ junction temperature range
- 5V turn-off Under Voltage Lockout (UVLO)
- Drives two N-channel MOSFETs in high-side and low-side configuration with independent inputs
- Maximum boot voltage 120V DC
- 3.7A source, 4.5A sink output currents
- Input pins can tolerate -10V to $+20\text{V}$ and are independent of supply voltage range
- TTL compatible Inputs
- 7V to 17V VDD operating range, (20V ABS maximum)
- 7.2ns rise and 5.5ns fall time with 1000pF load
- Fast propagation delay times (20ns typical)
- 4ns typical delay matching
- Available in the SOIC8 (PowerPAD) package

2 Applications

- Automotive DC/DC converters and OBC
- 2-wheeler and 3-wheeler traction drive and battery pack
- Electric power steering (EPS)
- Wireless charging
- Smart glass module

3 Description

The UCC27212A-Q1 device driver is based on the popular UCC27211 MOSFET drivers. In addition, UCC27212A-Q1 offers extended operating range all the way down to 5V which helps lower power losses.

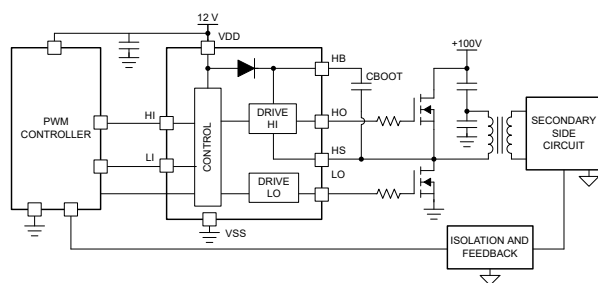

Typical Application Diagram

The peak output pullup and pulldown current is 3.7A source and 4.5A sink. This allows for the ability to drive large power MOSFETs with minimized switching losses during the e Miller Plateau of the MOSFET.

The input structure can directly handle -10V , which increases robustness and also allows direct interface to gate-drive transformers without using rectification diodes. The inputs are also independent of supply voltage and have a 20V maximum rating.

The switching node of the UCC27212A-Q1 (HS pin) can handle $-(24\text{V} - \text{VDD})$ maximum, which allows the high-side channel to be protected from inherent negative voltages caused by parasitic inductance and stray capacitance. The UCC27212A-Q1 has increased hysteresis that allows for interface to analog or digital PWM controllers with enhanced noise immunity. The low-side and high-side gate drivers are independently controlled and matched to ns between the turn on and turn off of each other. An on-chip 120V rated bootstrap diode eliminates the external discrete diodes. Undervoltage lockout is provided for both the high-side and the low-side drivers which provides symmetric turn on and turn off behavior and forces the outputs low drive voltage is below the specified threshold.

Device Information

PART NUMBER	PACKAGE ⁽¹⁾	BODY SIZE (NOM)
UCC27212A-Q1	DDA (PowerPAD™ SOIC, 8)	4.9mm x 3.9mm

- (1) For all available packages, see the orderable addendum at the end of the data sheet.

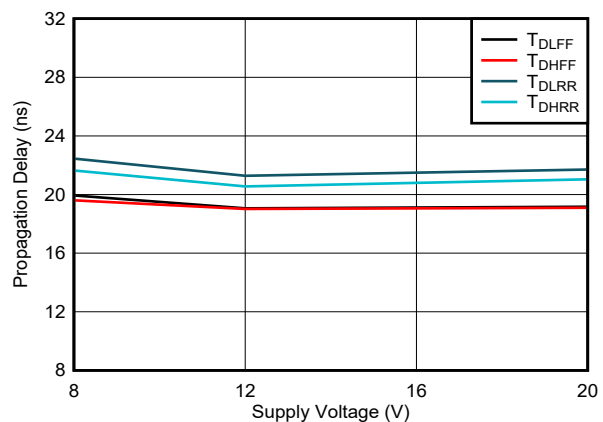

Propagation Delays vs Supply Voltage T = 25°C



Table of Contents

1 Features	1	7 Application and Implementation	14
2 Applications	1	7.1 Application Information.....	14
3 Description	1	7.2 Typical Application.....	15
4 Pin Configuration and Functions	3	8 Power Supply Recommendations	18
5 Specifications	4	9 Layout	19
5.1 Absolute Maximum Ratings.....	4	9.1 Layout Guidelines.....	19
5.2 ESD Ratings.....	4	9.2 Layout Example.....	20
5.3 Recommended Operating Conditions.....	4	10 Device and Documentation Support	21
5.4 Thermal Information.....	4	10.1 Device Support.....	21
5.5 Electrical Characteristics.....	5	10.2 Documentation Support.....	21
5.6 Switching Characteristics.....	6	10.3 Receiving Notification of Documentation Updates..	21
5.7 Timing Diagrams	7	10.4 Support Resources.....	21
5.8 Typical Characteristics.....	8	10.5 Trademarks.....	21
6 Detailed Description	11	10.6 Electrostatic Discharge Caution.....	21
6.1 Overview.....	11	10.7 Glossary.....	21
6.2 Functional Block Diagram.....	12	11 Revision History	22
6.3 Feature Description.....	12	12 Mechanical, Packaging, and Orderable	
6.4 Device Functional Modes.....	13	Information	23

4 Pin Configuration and Functions

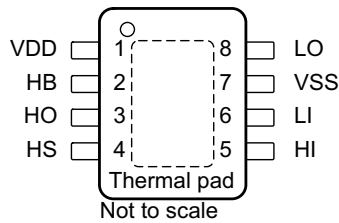

Figure 4-1. DDA Package 8-Pin SO-PowerPAD Top View

Table 4-1. Pin Functions

PIN		I/O	DESCRIPTION
NO.	NAME		
2	HB	P	High-side bootstrap supply. The bootstrap diode is on-chip but the external bootstrap capacitor is required. Connect positive side of the bootstrap capacitor to this pin. Typical range of HB bypass capacitor is 0.022 μ F to 0.1 μ F. The capacitor value is dependant on the gate charge of the high-side MOSFET and must also be selected based on speed and ripple criteria.
5	HI	I	High-side input. ⁽¹⁾
3	HO	O	High-side output. Connect to the gate of the high-side power MOSFET.
4	HS	P	High-side source connection. Connect to source of high-side power MOSFET. Connect the negative side of bootstrap capacitor to this pin.
6	LI	I	Low-side input. ⁽¹⁾
8	LO	O	Low-side output. Connect to the gate of the low-side power MOSFET.
1	VDD	P	Positive supply to the lower-gate driver. De-couple this pin to V_{SS} (GND). Typical decoupling capacitor range is 0.22 μ F to 4.7 μ F (See ⁽²⁾).
7	VSS	—	Negative supply terminal for the device that is generally grounded.
Pad	Thermal pad ⁽³⁾	—	Electrically referenced to V_{SS} (GND). Connect to a large thermal mass trace or GND plane to dramatically improve thermal performance.

- (1) HI or LI input is assumed to connect to a low impedance source signal. The source output impedance is assumed less than 100 Ω . If the source impedance is greater than 100 Ω , add a bypassing capacitor, each, between HI and VSS and between LI and VSS. The added capacitor value depends on the noise levels presented on the pins, typically from 1nF to 10nF should be effective to eliminate the possible noise effect. When noise is present on two pins, HI or LI, the effect is to cause HO and LO malfunctions to have wrong logic outputs.
- (2) For cold temperature applications TI recommends the upper capacitance range. Follow the [Section 9.1](#) for PCB layout.
- (3) The thermal pad is not directly connected to any leads of the package; however, it is electrically and thermally connected to the substrate which is the ground of the device.

5 Specifications

5.1 Absolute Maximum Ratings

Over operating free-air temperature range and all voltages are with respect to V_{SS} (unless otherwise noted).⁽¹⁾

		MIN	MAX	UNIT	
V_{DD}	Supply voltage	-0.3	20	V	
V_{HI}, V_{LI}	Input voltages on HI and LI	-10	20	V	
V_{LO}	Output voltage on LO	DC	-0.3	$V_{DD} + 0.3$	V
		Repetitive pulse < 100 ns ⁽²⁾	-2	$V_{DD} + 0.3$	
V_{HO}	Output voltage on HO	DC	$V_{HS} - 0.3$	$V_{HB} + 0.3$	V
		Repetitive pulse < 100 ns ⁽²⁾	$V_{HS} - 2$	$V_{HB} + 0.3$	
V_{HS}	Voltage on HS	DC	-1	100	V
		Repetitive pulse < 100 ns ⁽²⁾	-(24 V - VDD)	115	
V_{HB}	Voltage on HB	-0.3	120	V	
	Voltage on HB-HS	-0.3	20	V	
T_J	Operating junction temperature	-40	150	°C	
T_{stg}	Storage temperature	-65	150	°C	

- (1) Operation outside the *Absolute Maximum Ratings* may cause permanent device damage. *Absolute Maximum Ratings* do not imply functional operation of the device at these or any other conditions beyond those listed under *Recommended Operating Conditions*. If used outside the *Recommended Operating Conditions* but within the *Absolute Maximum Ratings*, the device may not be fully functional, and this may affect device reliability, functionality, performance, and shorten the device lifetime.
- (2) Values are verified by characterization and are not production tested.

5.2 ESD Ratings

		VALUE	UNIT	
$V_{(ESD)}$	Electrostatic discharge	Human-body model (HBM), per AEC Q100-002 ⁽¹⁾	±2000	V
		Charged-device model (CDM), per AEC Q100-011	±1500	

- (1) AEC Q100-002 indicates that HBM stressing shall be in accordance with the ANSI/ESDA/JEDEC JS-001 specification.

5.3 Recommended Operating Conditions

Over operating free-air temperature range and all voltages are with respect to V_{SS} (unless otherwise noted).

		MIN	NOM	MAX	UNIT
V_{DD}	Supply voltage	7	12	17	V
V_{HS}	Voltage on HS	-1		100	V
	Voltage on HS (repetitive pulse < 100 ns) ⁽¹⁾	-(20 V - VDD)		110	
V_{HB}	Voltage on HB	$V_{HS} + 8.0$		115	
SR_{HS}	Voltage slew rate on HS			50	V/ns
T_J	Operating junction temperature	-40		150	°C

- (1) Values are verified by characterization and are not production tested.

5.4 Thermal Information

THERMAL METRIC ⁽¹⁾		UCC27212A-Q1	UNIT
		DDA (PowerPad™ SOIC)	
		8 Pins	
$R_{\theta JA}$	Junction-to-ambient thermal resistance	47.1	°C/W
$R_{\theta JC(top)}$	Junction-to-case (top) thermal resistance	60.8	°C/W
$R_{\theta JB}$	Junction-to-board thermal resistance	21.3	°C/W
Ψ_{JT}	Junction-to-top characterization parameter	6.3	°C/W
Ψ_{JB}	Junction-to-board characterization parameter	21.3	°C/W

5.4 Thermal Information (continued)

THERMAL METRIC ⁽¹⁾		UCC27212A-Q1	UNIT
		DDA (PowerPad™ SOIC)	
		8 Pins	
R _{θJC(bot)}	Junction-to-case (bottom) thermal resistance	6.2	°C/W

(1) For more information about traditional and new thermal metrics, see the Semiconductor and IC Package Thermal Metrics application report, SPRA953.

5.5 Electrical Characteristics

V_{DD} = V_{HB} = 12 V, V_{HS} = V_{SS} = 0 V, No load on LO or HO, T_A = T_J = -40°C to +150°C (unless otherwise noted).

PARAMETER		TEST CONDITIONS	MIN	TYP	MAX	UNIT
SUPPLY CURRENTS						
I _{DD}	VDD quiescent current	V _{LI} = V _{HI} = 0 V		0.11	0.19	mA
I _{DDO}	VDD operating current	f = 500 kHz, C _{LOAD} = 0		1.4	3	mA
I _{HB}	Boot voltage quiescent current	V _{LI} = V _{HI} = 0 V		0.065	0.12	mA
I _{HBO}	Boot voltage operating current	f = 500 kHz, C _{LOAD} = 0		1.3	3	mA
I _{HBS}	HB to VSS quiescent current	V _{HS} = V _{HB} = 100 V		0.0005	1	μA
I _{HBSO}	HB to VSS operating current	f = 500 kHz, C _{LOAD} = 0		0.03	1	mA
INPUT						
V _{HIT_HI}	Input voltage high threshold		1.7	2.3	2.55	V
V _{HIT_LI}	Input voltage hig threshold		1.7	2.3	2.55	V
V _{LIT_HI}	Input voltage low threshold		1.2	1.6	1.9	V
V _{LIT_LI}	Input voltage low threshold		1.2	1.6	1.9	V
V _{IHYS_HI}	Input voltage Hysteresis			0.7		V
V _{IHYS_LI}	Input voltage Hysteresis			0.7		V
R _{IN_HI}	Input pulldown resistance	V _{IN} = 3V		68		kΩ
R _{IN_LI}	Input pulldown resistance	V _{IN} = 3V		68		kΩ
UNDERVOLTAGE PROTECTION (UVLO)						
V _{DDR}	VDD turnon threshold		4.9	5.7	6.4	V
V _{DDHYS}	VDD threshold hysteresis			0.4		V
V _{HBR}	VHB turnon threshold		4.35	5.3	6.3	V
V _{HBHYS}	VHB threshold hysteresis			0.3		V
BOOTSTRAP DIODE						
V _F	Low-current forward voltage	I _{VDD-HB} = 100 μA		0.65	0.85	V
V _{FI}	High-current forward voltage	I _{VDD-HB} = 100 mA		0.9	1.05	V
R _D	Dynamic resistance, ΔV _F /ΔI	I _{VDD-HB} = 160 mA and 180 mA	0.3	0.55	0.85	Ω
LO GATE DRIVER						
V _{LOL}	Low level output voltage	I _{LO} = 100 mA		0.07	0.19	V
V _{LOH}	High level output voltage	I _{LO} = -100 mA, V _{LOH} = V _{DD} - V _{LO}		0.11	0.29	V
	Peak pullup current ⁽¹⁾	V _{LO} = 0 V		3.7		A
	Peak pulldown current ⁽¹⁾	V _{LO} = 12 V		4.5		A
HO GATE DRIVER						
V _{HOL}	Low level output voltage	I _{HO} = 100 mA		0.07	0.19	V
V _{HOH}	High level output voltage	I _{HO} = -100 mA, V _{HOH} = V _{HB} - V _{HO}		0.11	0.29	V
	Peak pullup current ⁽¹⁾	V _{HO} = 0 V		3.7		A
	Peak pulldown current ⁽¹⁾	V _{HO} = 12 V		4.5		A

(1) Parameter not tested in production.

5.6 Switching Characteristics

$V_{DD} = V_{HB} = 12\text{ V}$, $V_{HS} = V_{SS} = 0\text{ V}$, No load on LO or HO, $T_A = T_J = -40^\circ\text{C}$ to $+150^\circ\text{C}$ (unless otherwise noted).

PARAMETER		TEST CONDITIONS	MIN	TYP	MAX	UNIT
PROPAGATION DELAYS						
t_{DLFF}	VLI falling to VLO falling	$C_{LOAD} = 0\text{ pF}$, from V_{LIT} of LI to 90% of LO falling	10	19	30	ns
t_{DHFF}	VHI falling to VHO falling	$C_{LOAD} = 0\text{ pF}$, from V_{LIT} of HI to 90% of HO falling	10	19	30	ns
t_{DLRR}	VLI rising to VLO rising	$C_{LOAD} = 0\text{ pF}$, from V_{HIT} of LI to 10% of LO rising	10	20	42	ns
t_{DHRR}	VHI rising to VHO rising	$C_{LOAD} = 0\text{ pF}$, $C_{LOAD} = 0\text{ pF}$, from V_{HIT} of HI to 10% of HO rising	10	20	42	ns
DELAY MATCHING						
t_{MON}	Delay from HO off to LO on	$T_J = 25^\circ\text{C}$		4	9.5	ns
t_{MON}	Delay from HO off to LO on	$T_J = -40^\circ\text{C}$ to 150°C		4	17	ns
t_{MOFF}	Delay from LO off to HO on	$T_J = 25^\circ\text{C}$		4	9.5	ns
t_{MOFF}	Delay from LO off to HO on	$T_J = -40^\circ\text{C}$ to 150°C		4	17	ns
OUTPUT RISE AND FALL TIME						
t_{R_LO}	LO rise time	$C_{LOAD} = 1000\text{ pF}$, from 10% to 90%		7.2		ns
t_{R_HO}	HO rise time	$C_{LOAD} = 1000\text{ pF}$, from 10% to 90%		7.2		ns
t_{F_LO}	LO fall time	$C_{LOAD} = 1000\text{ pF}$, from 10% to 90%		5.5		ns
t_{F_HO}	HO fall time	$C_{LOAD} = 1000\text{ pF}$, from 10% to 90%		5.5		ns
$t_{R_LO_p1}$	LO rise time (3 V to 9 V)	$C_{LOAD} = 0.1\text{ }\mu\text{F}$, (3V to 9V)		0.27	0.6	μs
$t_{R_HO_p1}$	HO rise time (3 V to 9 V)	$C_{LOAD} = 0.1\text{ }\mu\text{F}$, (3V to 9V)		0.27	0.6	μs
$t_{F_LO_p1}$	LO fall time (9 V to 3 V)	$C_{LOAD} = 0.1\text{ }\mu\text{F}$, (9V to 3V)		0.16	0.4	μs
$t_{F_HO_p1}$	HO fall time (9 V to 3 V)	$C_{LOAD} = 0.1\text{ }\mu\text{F}$, (9V to 3V)		0.16	0.4	μs
MISCELLANEOUS						
t_{IN_PW}	Minimum input pulse width that changes the output LO				40	ns
t_{IN_PW}	Minimum input pulse width that changes the output HO				40	ns
t_{OFF_BSD}	Bootstrap diode turnoff time ^{(1) (2)}	$I_F = 20\text{ mA}$, $I_{REV} = 0.5\text{ A}$ ⁽³⁾		20		ns

(1) Parameter not tested in production.

(2) Typical values for $T_A = 25^\circ\text{C}$.

(3) I_F : Forward current applied to bootstrap diode, I_{REV} : Reverse current applied to bootstrap diode.

5.7 Timing Diagrams

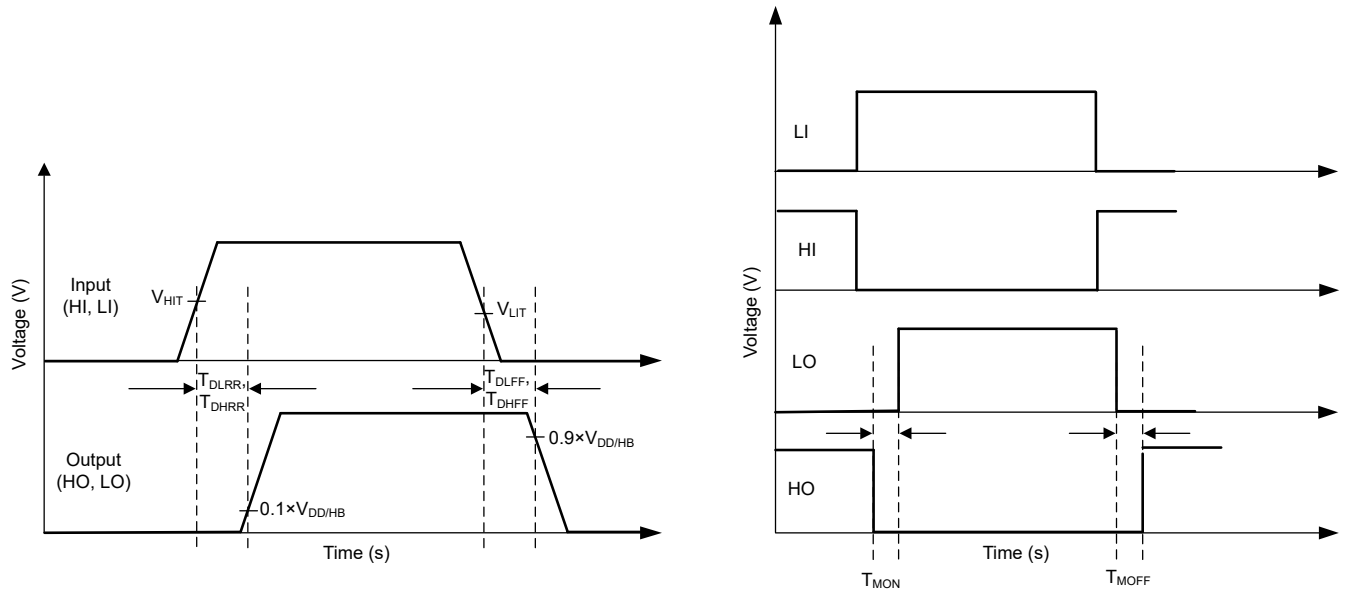

Figure 5-1. Timing Diagrams

5.8 Typical Characteristics

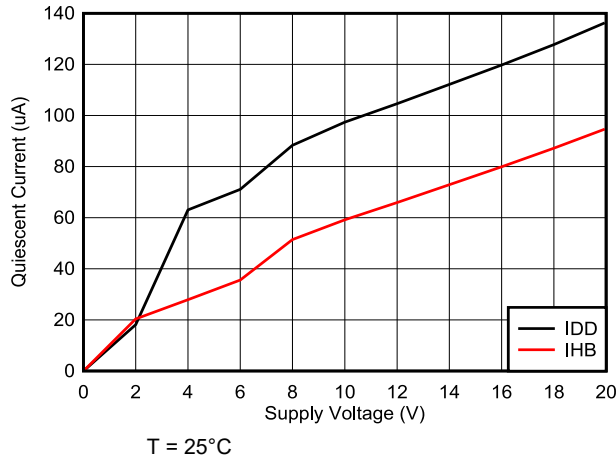

Figure 5-2. Quiescent Current vs Supply Voltage

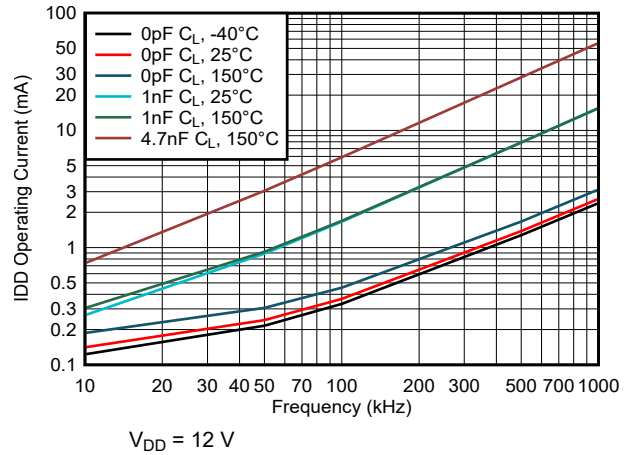

Figure 5-3. IDD Operating Current vs Frequency

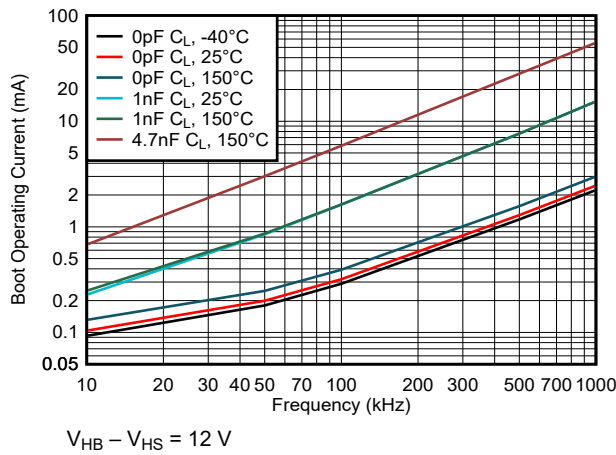

Figure 5-4. Boot Voltage Operating Current vs Frequency (HB To HS)

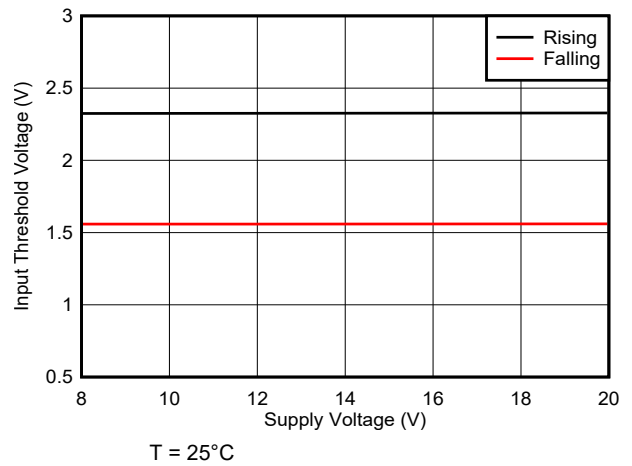

Figure 5-5. Input Threshold vs Supply Voltage

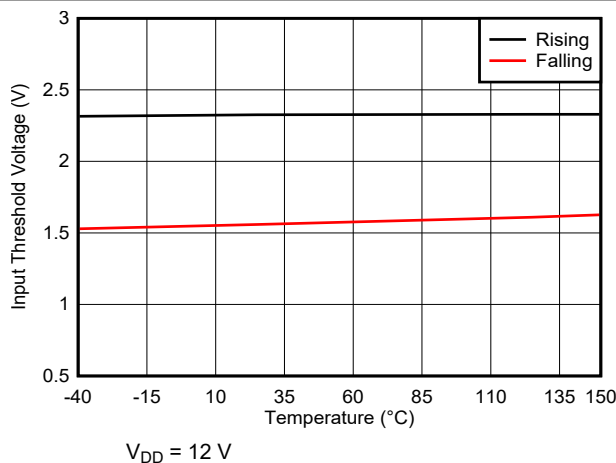

Figure 5-6. Input Thresholds vs Temperature

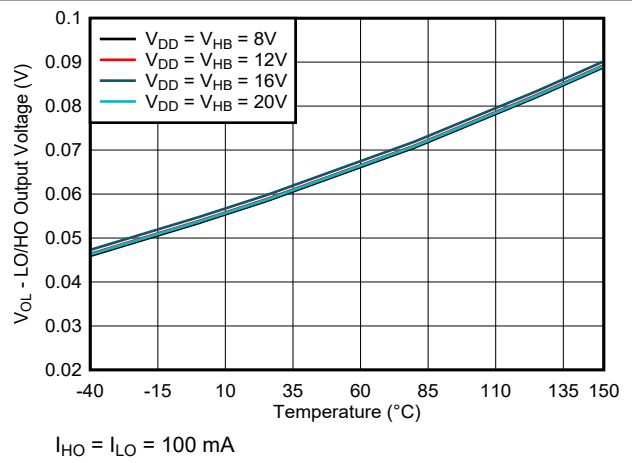
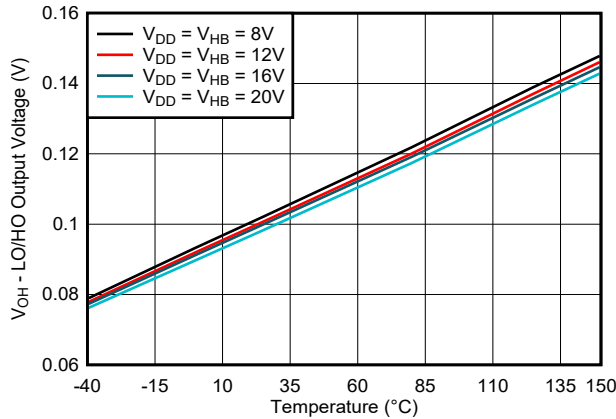

Figure 5-7. LO and HO Low-Level Output Voltage vs Temperature

5.8 Typical Characteristics (continued)



$I_{HO} = I_{LO} = 100 \text{ mA}$

Figure 5-8. LO and HO High-Level Output Voltage vs Temperature

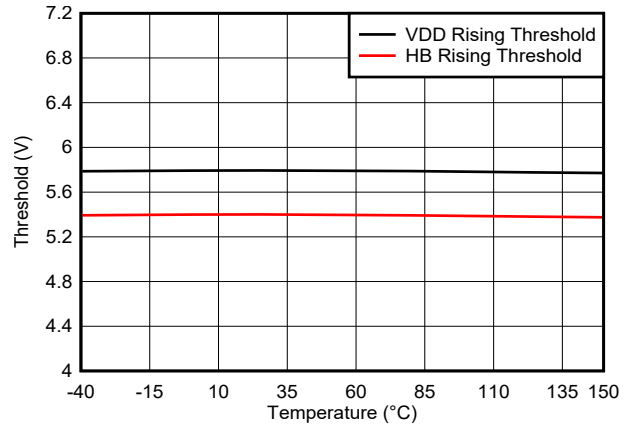

Figure 5-9. Undervoltage Lockout Threshold vs Temperature

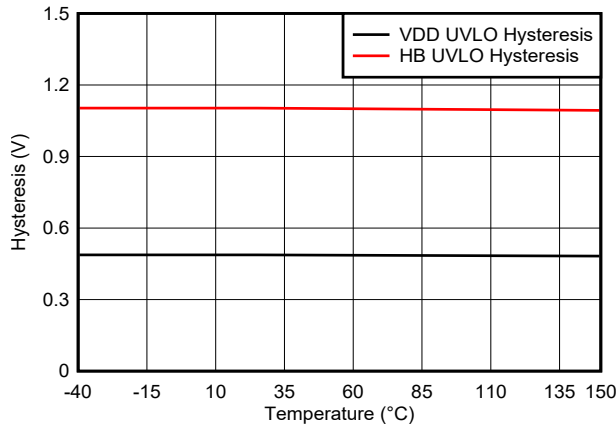
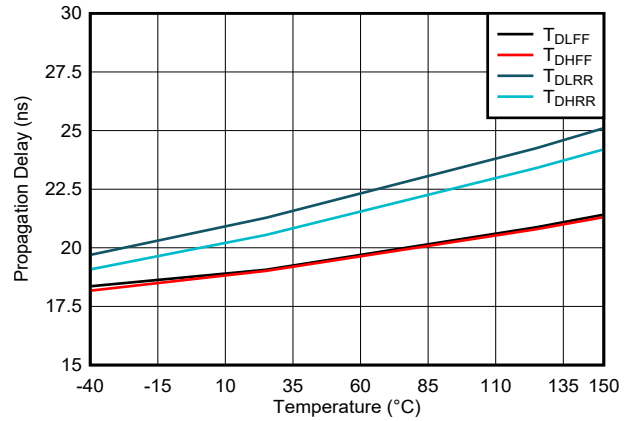
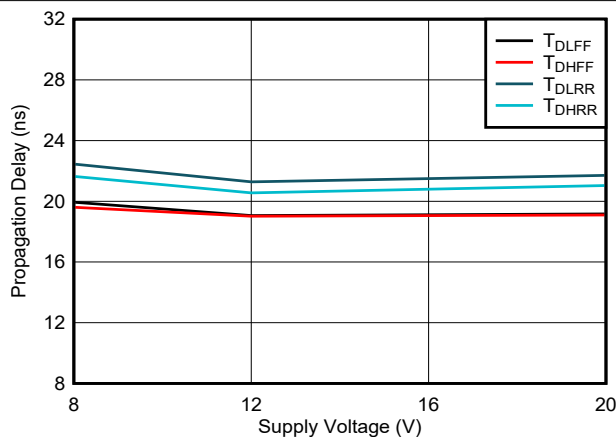

Figure 5-10. Undervoltage Lockout Threshold Hysteresis vs Temperature



$V_{DD} = V_{HB} = 12 \text{ V}$

Figure 5-11. Propagation Delays vs Temperature



$T = 25^\circ\text{C}$

Figure 5-12. Propagation Delays vs Supply Voltage ($V_{DD} = V_{HB}$)

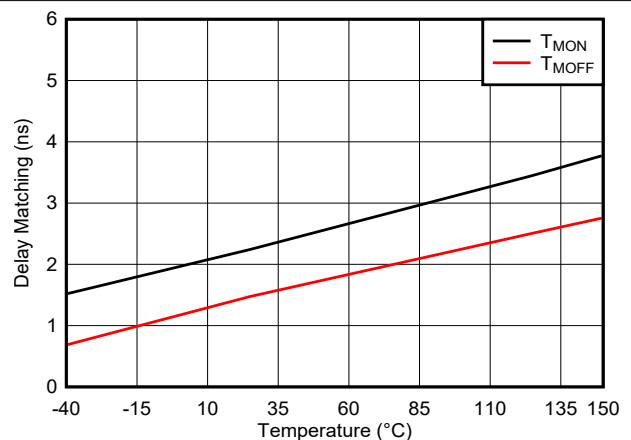

$V_{DD} = V_{HB} = 12 \text{ V}$

Figure 5-13. Delay Matching vs Temperature

5.8 Typical Characteristics (continued)

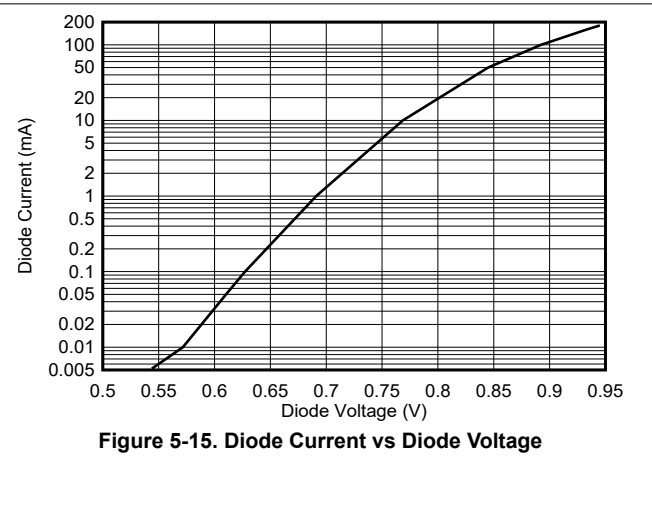
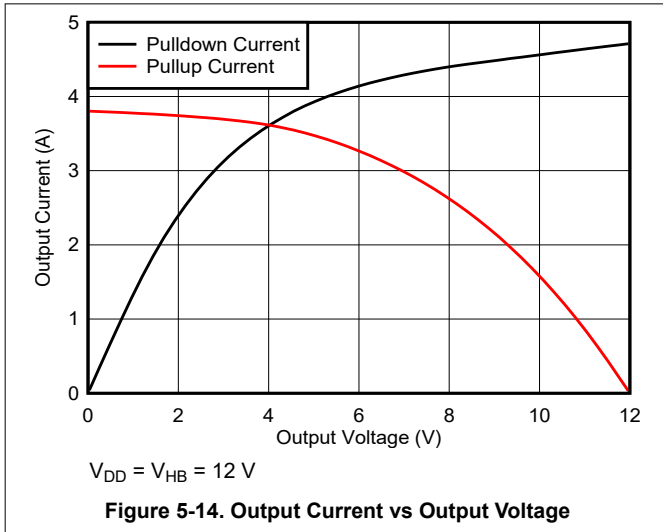

6 Detailed Description

6.1 Overview

The UCC27212A-Q1 device is designed to drive both the high-side and low-side of N-Channel MOSFETs in a half- and full-bridge or synchronous-buck configuration. The floating high-side driver can operate with supply voltages of up to 120V, which allows for N-Channel MOSFET control in half-bridge, full-bridge, push-pull, two-switch forward, and active clamp forward converters.

The UCC27212A-Q1 device feature 3.7A source and 4.5A sink capability, industry best-in-class switching characteristics and a host of other features listed in [Table 6-1](#). These features combine to ensure efficient, robust and reliable operation in high-frequency switching power circuits.

Table 6-1. UCC27212A-Q1 Highlights

FEATURE	BENEFIT
3.7A source and 4.5A sink current	High peak current ideal for driving large power MOSFETs with minimal power loss (fast-drive capability at Miller plateau)
Input pins (HI and LI) can directly handle –10VDC up to 20VDC	Increased robustness and ability to handle undershoot and overshoot can interface directly to gate-drive transformers without having to use rectification diodes.
120V internal boot diode	Provides voltage margin to meet telecom 100V surge requirements
Switch node (HS pin) able to handle $-(24 - VDD)$ V maximum for 100ns	Allows the high-side channel to have extra protection from inherent negative voltages caused by parasitic inductance and stray capacitance
Robust ESD circuitry to handle voltage spikes	Excellent immunity to large dV/dT conditions
20ns propagation delay with 7.2ns rise time and 5.5ns fall time	Best-in-class switching characteristics and extremely low-pulse transmission distortion
4ns (typical) delay matching between channels	Avoids transformer volt-second offset in bridge
Symmetrical UVLO circuit	Ensures high-side and low-side shut down at the same time
TTL optimized thresholds with increased hysteresis	Complementary to analog or digital PWM controllers; increased hysteresis offers added noise immunity

In the UCC27212A-Q1 device, the high side and low side each have independent inputs that allow maximum flexibility of input control signals in the application. The boot diode for the high-side driver bias supply is internal to the UCC27212A-Q1. The UCC27212A-Q1 is the TTL or logic compatible version. The high-side driver is referenced to the switch node (HS), which is typically the source pin of the high-side MOSFET and drain pin of the low-side MOSFET. The low-side driver is referenced to V_{SS} , which is typically ground. The UCC27212A-Q1 functions are divided into the input stages, UVLO protection, level shift, boot diode, and output driver stages.

6.2 Functional Block Diagram

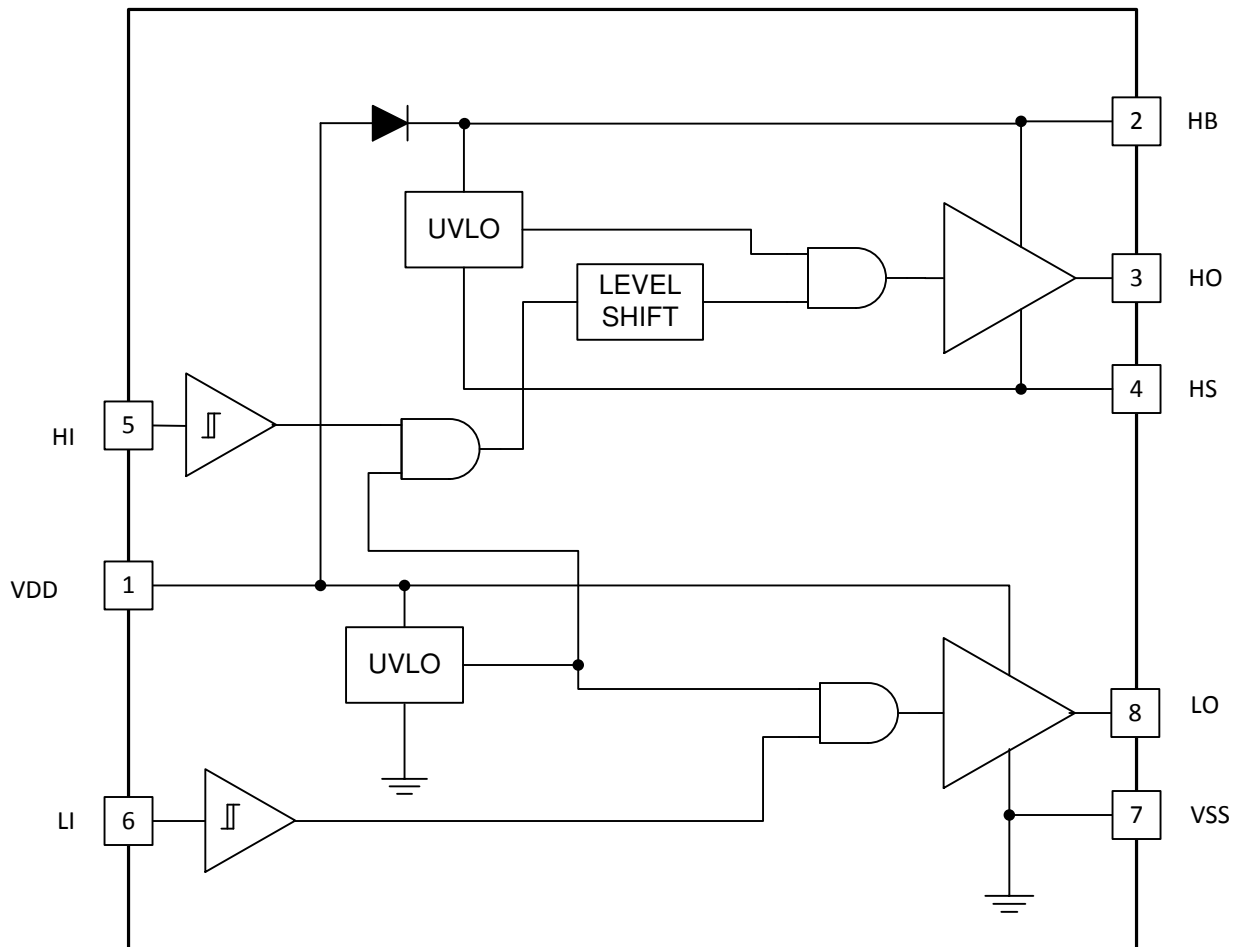

Copyright © 2017, Texas Instruments Incorporated

6.3 Feature Description

6.3.1 Input Stages

The input stages provide the interface to the PWM output signals. The input stages of the UCC27212A-Q1 device have impedance of 68kΩ nominal and input capacitance is approximately 4pF. Pulldown resistance to V_{SS} (ground) is 68kΩ. The logic level compatible input provides a rising threshold of 2.3V and a falling threshold of 1.6V. There is enough input hysteresis to avoid noise related jitter issues on the input.

6.3.2 Undervoltage Lockout (UVLO)

Minor fix to input pulldown resistance typical spec to match electrical characteristics table.

The bias supplies for the high-side and low-side drivers have UVLO protection. V_{DD} as well as V_{HB} to V_{HS} differential voltages are monitored. The V_{DD} UVLO disables both drivers when V_{DD} is below the specified threshold. The rising V_{DD} threshold is 5.7V with 0.4V hysteresis. The V_{HB} UVLO disables only the high-side driver when the V_{HB} to V_{HS} differential voltage is below the specified threshold. The V_{HB} UVLO rising threshold is 5.3V with 0.3V hysteresis.

6.3.3 Level Shift

The level shift circuit is the interface from the high-side input to the high-side driver stage which is referenced to the switch node (HS). The level shift allows control of the HO output referenced to the HS pin and provides excellent delay matching with the low-side driver.

6.3.4 Boot Diode

The boot diode necessary to generate the high-side bias is included in the UCC27212A-Q1 family of drivers. The diode anode is connected to V_{DD} and cathode connected to V_{HB} . With the V_{HB} capacitor connected to HB and the HS pins, the V_{HB} capacitor charge is refreshed every switching cycle when HS transitions to ground. The boot diode provides fast recovery times, low diode resistance, and voltage rating margin to allow for efficient and reliable operation.

6.3.5 Output Stages

The output stages are the interface to the power MOSFETs in the power train. High slew rate, low resistance and high peak current capability of both output drivers allow for efficient switching of the power MOSFETs. The low-side output stage is referenced from V_{DD} to V_{SS} and the high side is referenced from V_{HB} to V_{HS} .

6.4 Device Functional Modes

The device operates in normal mode and UVLO mode. See the [Section 6.3.2](#) section for information on UVLO operation mode. In the normal mode the output state is dependent on states of the HI and LI pins. [Table 6-2](#) lists the output states for different input pin combinations.

Table 6-2. Device Logic Table

HI PIN	LI PIN	HO ⁽¹⁾	LO ⁽²⁾
L	L	L	L
L	H	L	H
H	L	H	L
H	H	H	H

- (1) HO is measured with respect to HS.
- (2) LO is measured with respect to VSS.

7 Application and Implementation

Note

Information in the following applications sections is not part of the TI component specification, and TI does not warrant its accuracy or completeness. TI's customers are responsible for determining suitability of components for their purposes, as well as validating and testing their design implementation to confirm system functionality.

7.1 Application Information

To affect fast switching of power devices and reduce associated switching power losses, a powerful gate driver is employed between the PWM output of controllers and the gates of the power semiconductor devices. Also, gate drivers are indispensable when it is impossible for the PWM controller to directly drive the gates of the switching devices. With the advent of digital power, this situation will be often encountered because the PWM signal from the digital controller is often a 3.3V logic signal which cannot effectively turn on a power switch. Level shifting circuitry is needed to boost the 3.3V signal to the gate-drive voltage (such as 12V) in order to fully turn on the power device and minimize conduction losses. Traditional buffer drive circuits based on NPN/PNP bipolar transistors in totem-pole arrangement, being emitter follower configurations, prove inadequate with digital power because they lack level-shifting capability. Gate drivers effectively combine both the level-shifting and buffer-drive functions. Gate drivers also find other needs such as minimizing the effect of high-frequency switching noise by locating the high-current driver physically close to the power switch, driving gate-drive transformers, and controlling floating power-device gates, reducing power dissipation and thermal stress in controllers by moving gate charge power losses from the controller into the driver.

Finally, emerging wide band-gap power device technologies such as GaN based switches, which are capable of supporting very high switching frequency operation, are driving very special requirements in terms of gate drive capability. These requirements include operation at low VDD voltages (5V or lower), low propagation delays and availability in compact, low-inductance packages with good thermal capability. Gate-driver devices are extremely important components in switching power, and they combine the benefits of high-performance, low-cost component count and board-space reduction as well as simplified system design.

7.2 Typical Application

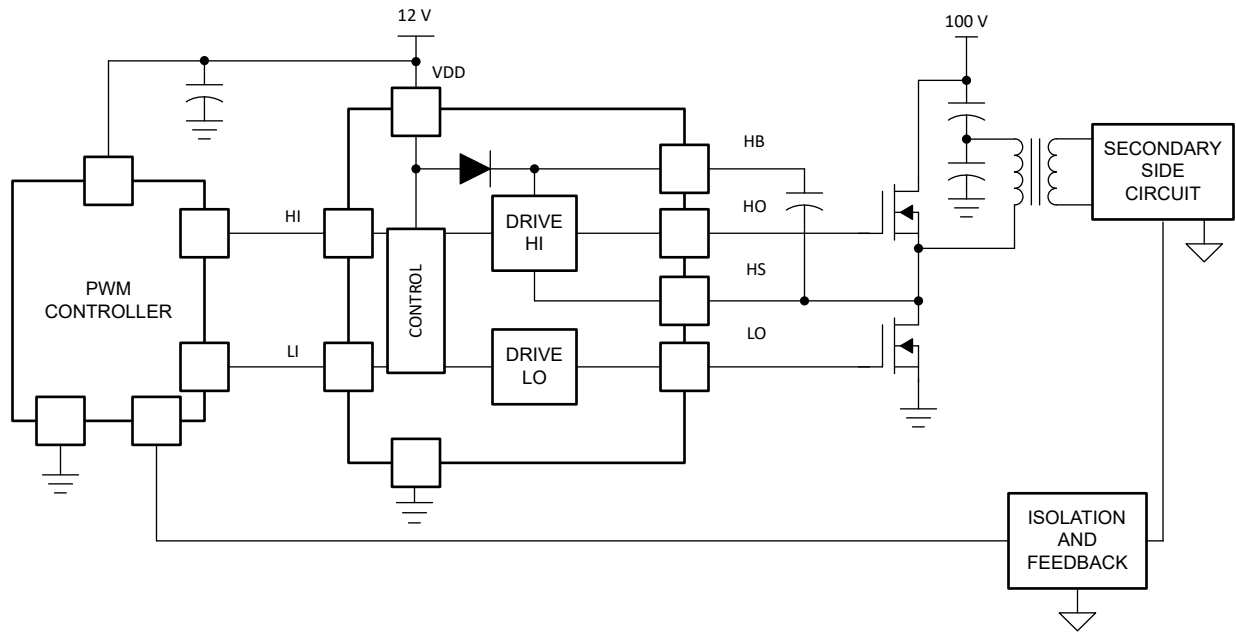

Copyright © 2017, Texas Instruments Incorporated

Figure 7-1. UCC27212A-Q1 Typical Application

7.2.1 Design Requirements

For this design example, use the parameters listed in [Table 7-1](#).

Table 7-1. Design Specifications

DESIGN PARAMETER	EXAMPLE VALUE
Supply voltage, VDD	12V
Voltage on HS, VHS	0V to 100V
Voltage on HB, VHB	12V to 112V
Output current rating, IO	-4.5A/3.7A
Operating frequency	500kHz

7.2.2 Detailed Design Procedure

7.2.2.1 Power Dissipation

Power dissipation of the gate driver has two portions as shown in [Equation 1](#).

$$P_{DISS} = P_{DC} + P_{SW} \quad (1)$$

Use [Equation 2](#) to calculate the DC portion of the power dissipation (PDC).

$$PDC = I_Q \times V_{DD} \quad (2)$$

where

- I_Q is the quiescent current for the driver.

The quiescent current is the current consumed by the device to bias all internal circuits such as input stage, reference voltage, logic circuits, protections, and also any current associated with switching of internal devices when the driver output changes state (such as charging and discharging of parasitic capacitances, parasitic shoot-through, and so forth). The UCC27212A-Q1 features very low quiescent currents (less than 0.17mA, refer to the [Section 7.2.2.1](#) table and contain internal logic to eliminate any shoot-through in the output driver stage. Thus the effect of the PDC on the total power dissipation within the gate driver can be safely assumed to be negligible. The power dissipated in the gate-driver package during switching (PSW) depends on the following factors:

- Gate charge required of the power device (usually a function of the drive voltage V_G , which is very close to input bias supply voltage V_{DD})
- Switching frequency
- Use of external gate resistors. When a driver device is tested with a discrete, capacitive load calculating the power that is required from the bias supply is fairly simple. The energy that must be transferred from the bias supply to charge the capacitor is given by [Equation 3](#).

$$EG = \frac{1}{2} C_{LOAD} \times V_{DD}^2 \quad (3)$$

where

- C_{LOAD} is load capacitor
- V_{DD} is bias voltage feeding the driver

There is an equal amount of energy dissipated when the capacitor is charged and when it is discharged. This leads to a total power loss given by [Equation 4](#).

$$PG = C_{LOAD} \times V_{DD}^2 \times f_{SW} \quad (4)$$

where

- f_{SW} is the switching frequency

The switching load presented by a power MOSFET/IGBT is converted to an equivalent capacitance by examining the gate charge required to switch the device. This gate charge includes the effects of the input capacitance plus the added charge needed to swing the drain voltage of the power device as it switches between the ON and OFF states. Most manufacturers provide specifications of typical and maximum gate charge, in nC, to switch the device under specified conditions. Using the gate charge Q_G , determine the power that must be dissipated when switching a capacitor which is calculated using the equation $Q_G = C_{LOAD} \times V_{DD}$ to provide [Equation 5](#) for power.

$$P_G = C_{LOAD} \times V_{DD}^2 \times f_{SW} = Q_G \times V_{DD} \times f_{SW} \quad (5)$$

This power P_G is dissipated in the resistive elements of the circuit when the MOSFET/IGBT is being turned on and off. Half of the total power is dissipated when the load capacitor is charged during turnon, and the other half is dissipated when the load capacitor is discharged during turnoff. When no external gate resistor is employed

between the driver and MOSFET/IGBT, this power is completely dissipated inside the driver package. With the use of external gate-drive resistors, the power dissipation is shared between the internal resistance of driver and external gate resistor.

7.2.3 Application Curves

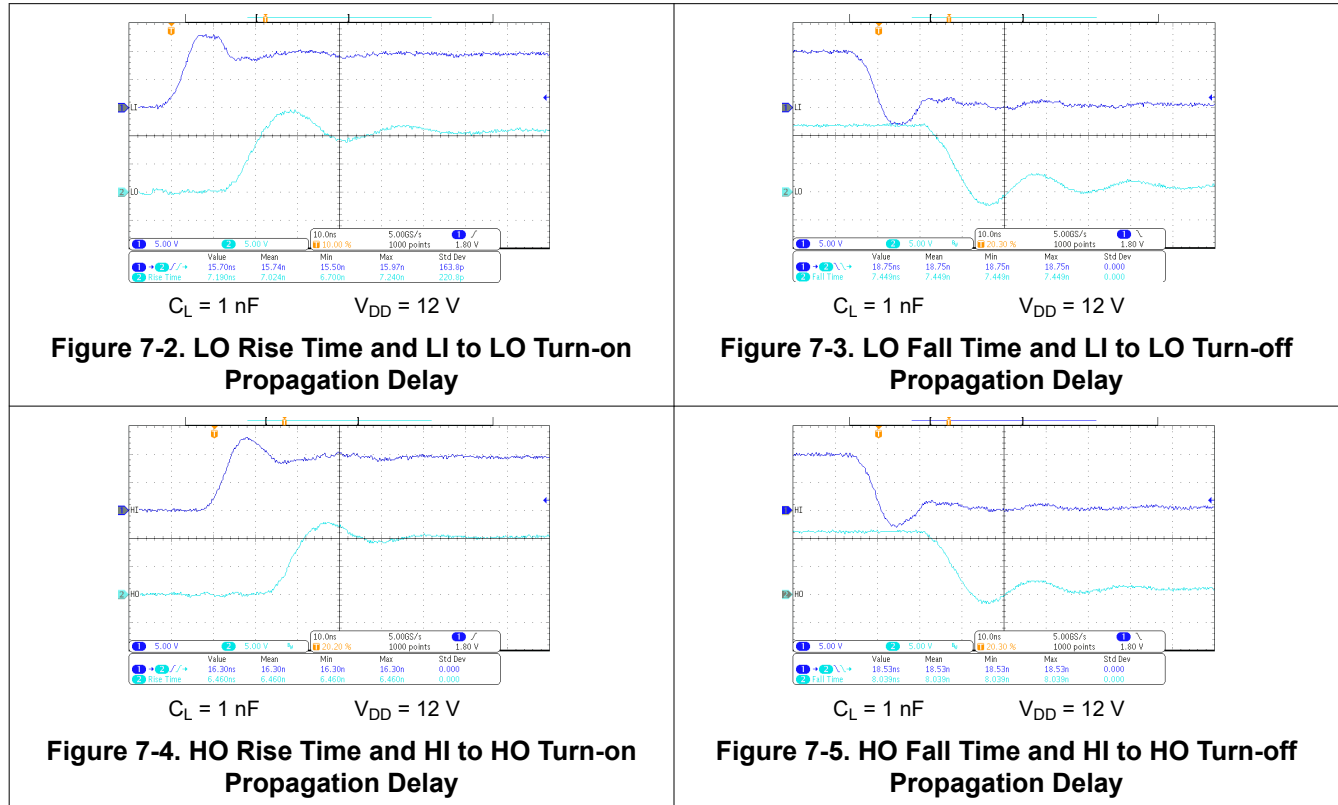

8 Power Supply Recommendations

The bias supply voltage range for which the UCC27212A-Q1 device is recommended to operate is from 7V to 17V. The lower end of this range is governed by the internal undervoltage-lockout (UVLO) protection feature on the V_{DD} pin supply circuit blocks. Whenever the driver is in UVLO condition when the V_{DD} pin voltage is below the $V_{(ON)}$ supply start threshold, this feature holds the output low, regardless of the status of the inputs. The upper end of this range is driven by the 20V absolute maximum voltage rating of the V_{DD} pin of the device (which is a stress rating). Keeping a 3V margin to allow for transient voltage spikes, the maximum recommended voltage for the V_{DD} pin is 17V. The UVLO protection feature also involves a hysteresis function, which means that when the V_{DD} pin bias voltage has exceeded the threshold voltage and device begins to operate, and if the voltage drops, then the device continues to deliver normal functionality unless the voltage drop exceeds the hysteresis specification $V_{DD(hys)}$. Therefore, ensuring that, while operating at or near the 7V range, the voltage ripple on the auxiliary power supply output is smaller than the hysteresis specification of the device is important to avoid triggering device shutdown. During system shutdown, the device operation continues until the V_{DD} pin voltage has dropped below the $V_{(OFF)}$ threshold, which must be accounted for while evaluating system shutdown timing design requirements. Likewise, at system start-up the device does not begin operation until the V_{DD} pin voltage has exceeded the $V_{(ON)}$ threshold.

The quiescent current consumed by the internal circuit blocks of the device is supplied through the V_{DD} pin. Although this fact is well known, it is important to recognize that the charge for source current pulses delivered by the LO pin is also supplied through the same V_{DD} pin. As a result, every time a current is sourced out of the LO pin, a corresponding current pulse is delivered into the device through the V_{DD} pin. Thus, ensure that a local bypass capacitor is provided between the V_{DD} and GND pins and located as close to the device as possible for the purpose of decoupling is important. A low-ESR, ceramic surface-mount capacitor is required. TI recommends using a capacitor in the range 0.22 μ F to 4.7 μ F between V_{DD} and GND. In a similar manner, the current pulses delivered by the HO pin are sourced from the HB pin. Therefore a 0.022 μ F to 0.1 μ F local decoupling capacitor is recommended between the HB and HS pins.

9 Layout

9.1 Layout Guidelines

To improve the switching characteristics and efficiency of a design, the following layout rules must be followed.

- Locate the driver as close as possible to the MOSFETs.
- Locate the $V_{DD} - V_{SS}$ and $V_{HB} - V_{HS}$ (bootstrap) capacitors as close as possible to the device (see [Section 9.1](#)).
- Pay close attention to the GND trace. Use the thermal pad of the package as GND by connecting it to the VSS pin (GND). The GND trace from the driver goes directly to the source of the MOSFET, but must not be in the high current path of the MOSFET drain or source current.
- Use similar rules for the HS node as for GND for the high-side driver.
- For systems using multiple UCC27212A-Q1 devices, TI recommends that dedicated decoupling capacitors be located at $V_{DD} - V_{SS}$ for each device.
- Care must be taken to avoid placing VDD traces close to LO, HS, and HO signals.
- Use wide traces for LO and HO closely following the associated GND or HS traces. A width of 60 to 100mils is preferable where possible.
- Use as least two or more vias if the driver outputs or SW node must be routed from one layer to another. For GND, the number of vias must be a consideration of the thermal pad requirements as well as parasitic inductance.
- Avoid LI and HI (driver input) going close to the HS node or any other high dV/dT traces that can induce significant noise into the relatively high impedance leads.

A poor layout can cause a significant drop in efficiency or system malfunction, and it can even lead to decreased reliability of the whole system.

9.2 Layout Example

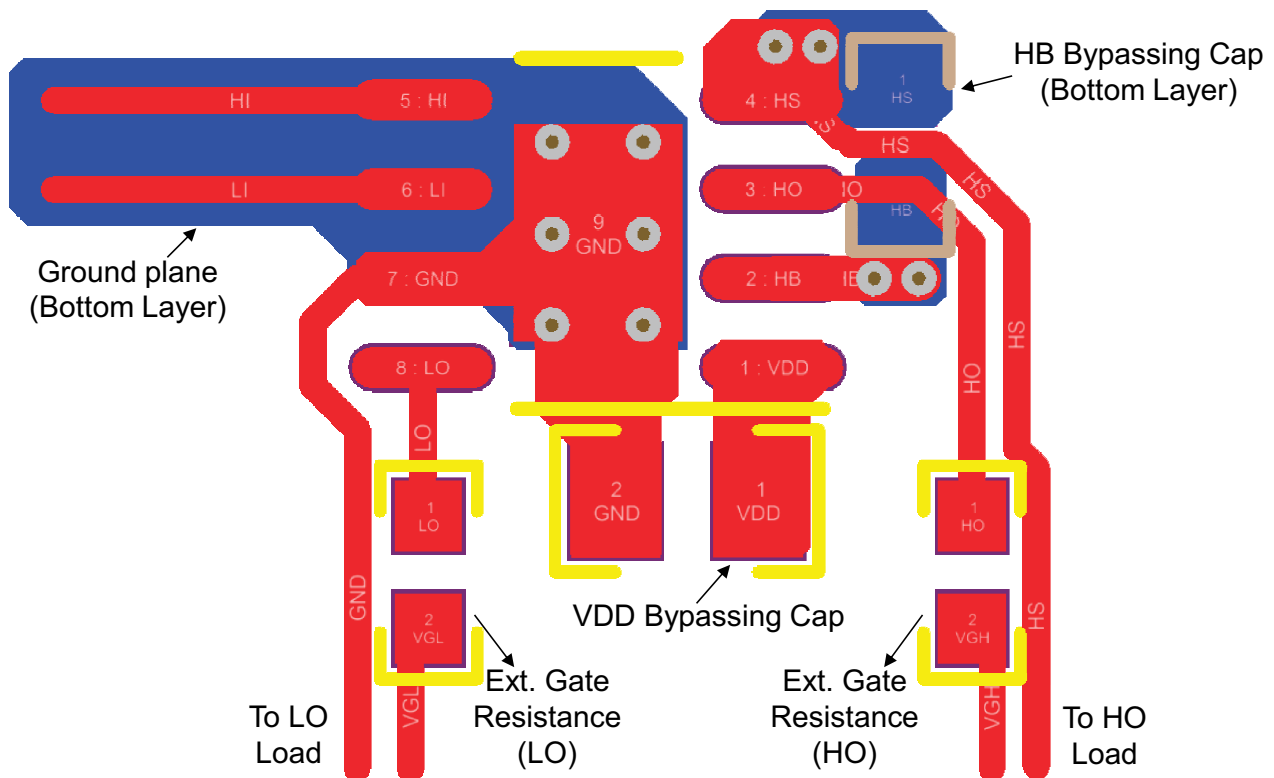

Figure 9-1. UCC27212A-Q1 Layout Example

9.2.1 Thermal Considerations

The useful range of a driver is greatly affected by the drive-power requirements of the load and the thermal characteristics of the package. For a gate driver to be useful over a particular temperature range, the package must allow for efficient removal of the heat produced while keeping the junction temperature within rated limits. The thermal metrics for the driver package are listed in [Section 9.2.1](#). For detailed information regarding the table, refer to the Application Note from Texas Instruments entitled *Semiconductor and IC Package Thermal Metrics* (SPRA953). The UCC27212A-Q1 device is offered in SOIC (8) and VSON (8).

10 Device and Documentation Support

10.1 Device Support

10.1.1 Third-Party Products Disclaimer

TI'S PUBLICATION OF INFORMATION REGARDING THIRD-PARTY PRODUCTS OR SERVICES DOES NOT CONSTITUTE AN ENDORSEMENT REGARDING THE SUITABILITY OF SUCH PRODUCTS OR SERVICES OR A WARRANTY, REPRESENTATION OR ENDORSEMENT OF SUCH PRODUCTS OR SERVICES, EITHER ALONE OR IN COMBINATION WITH ANY TI PRODUCT OR SERVICE.

10.2 Documentation Support

10.2.1 Related Documentation

For related documentation see the following:

- [PowerPAD™ Thermally Enhanced Package](#), Application Report
- [PowerPAD™ Made Easy](#), Application Report

10.3 Receiving Notification of Documentation Updates

To receive notification of documentation updates, navigate to the device product folder on ti.com. Click on *Notifications* to register and receive a weekly digest of any product information that has changed. For change details, review the revision history included in any revised document.

10.4 Support Resources

[TI E2E™ support forums](#) are an engineer's go-to source for fast, verified answers and design help — straight from the experts. Search existing answers or ask your own question to get the quick design help you need.

Linked content is provided "AS IS" by the respective contributors. They do not constitute TI specifications and do not necessarily reflect TI's views; see TI's [Terms of Use](#).

10.5 Trademarks

TI E2E™ is a trademark of Texas Instruments.

All trademarks are the property of their respective owners.

10.6 Electrostatic Discharge Caution



This integrated circuit can be damaged by ESD. Texas Instruments recommends that all integrated circuits be handled with appropriate precautions. Failure to observe proper handling and installation procedures can cause damage.

ESD damage can range from subtle performance degradation to complete device failure. Precision integrated circuits may be more susceptible to damage because very small parametric changes could cause the device not to meet its published specifications.

10.7 Glossary

[TI Glossary](#) This glossary lists and explains terms, acronyms, and definitions.

11 Revision History

NOTE: Page numbers for previous revisions may differ from page numbers in the current version.

Changes from Revision * (July 2017) to Revision A (July 2024)	Page
• Changed document title to reflect the device's key features.	1
• Changed several specifications to reflect the device characteristics. Deleted specifications for 6.8V. Left only specifications for 12V as is typical for all half-bridge drivers.....	1
• Updated Features section: 1) Deleted HBM and CDM ESD classification level to follow latest TI data sheet standards. 2) Changed junction temperature range spec (From: -40°C to 140°C. To: -40°C to 150°C). 3) Changed sink/source current to use exact typical specification, no change in actual device specification (From: "4-A/4-A". To: "3.7-A/4.5-A"). 4) Updated typo on VDD operating range, no change in actual device specification (From 5-V to 17-V. To: 7-V to 17-V). 5) Deleted 0.9-Ω Pullup and Pulldown Resistance since it is not specified in the Electrical Characteristics table.	1
• Updated Applications section with list of top 5 typical applications.....	1
• Changed Description section: 1) Changed peak currents (From: 4-A source and 4-A sink. To: 3.7A source and 4.5A sink). 2) Deleted and pullup and pulldown resistance is 0.9Ω since this parameter is not specified. 3) Changed From: 100-V rated bootstrap diode To: 120-V rated bootstrap diode. 3) Changed device information table body size, no change in actual package (From: SOIC8 (powerpad) package, 5mm x 6mm body size. To: DDA (PowerPADtm SOIC, 8) package, 4.9mm x 3.9mm body size. 4) Updated propagation delay plot. 5) Changed HS abs max to reflect specification in Absolute Maximum table (From: -18V. To: -(24V-VDD)).....	1
• Updated Recommended Operating Conditions: Operating Junction Temperature maximum changed from 140°C to 150°C.....	4
• Updated Thermal Information section to reflect device characteristics.	4
• Updated Electrical Characteristics and Switching Characteristics tables to remove specifications for 6.8V VDD, leaving the specifications for 12V VDD test condition, as typically done in gate driver datasheets.	4
• Updated Supply Currents specifications in the Electrical Characteristics table: 1) Minimum specification removed for I _{DD} , I _{DDO} , I _{HB} and I _{HBO} . 2) I _{DD} typical changed (From: 0.085mA. To: 0.11mA). 3) I _{DDO} typical changed (From: 2.5mA. To: 1.4mA). 4) I _{DDO} maximum changed (From: 6.5mA. To: 3mA). 5) I _{HBO} typical changed (From: 2.5mA. To: 1.3mA). 6) I _{HBO} maximum changed (From: 5.1mA. To: 3mA). 8) I _{HBS} test condition changed to match V _{HS} maximum recommended operating conditions (From: 115V. To: 100V). 9) I _{HBSO} typical changed (From: 0.07mA. To: 0.03mA). 10) I _{HBSO} maximum changed (From: 1.2mA. To: 1mA). .	4
• Updated Bootstrap diode specifications in the Electrical Characteristics table: 1) V _F maximum changed (From: 0.8V. To: 0.85V). 2) V _{FI} typical changed (From: 0.85V. To: 0.9V), and maximum changed (From: 0.95V. To: 1.05V). 3) R _D test conditions changed (From: 100mA and 80mA. To: 180mA and 160mA). 4) R _D typical changed (From: 0.5Ω. To: 0.55Ω).	4
• Updated LO/HO Gate Driver specifications in the Electrical Characteristics table: 1) Minimum specification removed for V _{LOL} , V _{LOH} , V _{HOL} , V _{HOH} . 2) V _{LOL} and V _{HOL} typical changed (From 0.1V. To 0.07V). 3) V _{LOH} and V _{HOH} typical changed (From: 0.16V. To: 0.11V).....	4
• Updated Propagation Delays specifications in the Switching Characteristics table: 1) Changed T _{DLFF} and T _{DHFF} typicals (From: 16ns. To: 19ns).	4
• Updated Output Rise and Fall Time specifications in the Switching Characteristic table: 1) t _R with 1000pF C _{LOAD} changed (From: 7.8ns typical. To: 7.2ns typical). 2) t _F with 1000pF C _{LOAD} changed (From: 6ns typical. To: 5.5ns typical). 3) t _R with 1uF C _{LOAD} changed (From: 0.36us typical. To: 0.27us typical). 4) t _F with 0.1uF C _{LOAD} changed (From: 0.20us typical. To: 0.16us typical).	4
• Updated Miscellaneous specifications in the Switching Characteristics table: t _{IN_PW} maximum changed (From: 100ns. To: 40ns).....	4
• Updated all plots in Typical Characteristics section to reflect the typical specification of the device.	8
• Changed typical specifications mentioned in the Overview section to match the device specifications in the Electrical Characteristics table.....	11
• Changed Input Stages section to match the input pulldown resistance typical specification in the electrical characteristics table (From: 70kΩ. To: 68kΩ).	12

-
- Changed Undervoltage Lockout (UVLO) section to VHB UVLO hysteresis to match electrical characteristics table (From: 0.4V. To: 0.3V)..... 12
 - Changed application curves to display propagation delay and rise/fall time plots. 17
-

12 Mechanical, Packaging, and Orderable Information

The following pages include mechanical, packaging, and orderable information. This information is the most current data available for the designated devices. This data is subject to change without notice and revision of this document. For browser-based versions of this data sheet, refer to the left-hand navigation.

PACKAGING INFORMATION

Orderable Device	Status (1)	Package Type	Package Drawing	Pins	Package Qty	Eco Plan (2)	Lead finish/ Ball material (6)	MSL Peak Temp (3)	Op Temp (°C)	Device Marking (4/5)	Samples
UCC27212AQDDARQ1	ACTIVE	SO PowerPAD	DDA	8	2500	RoHS & Green	NIPDAUAG	Level-2-260C-1 YEAR	-40 to 150	27212Q	Samples

(1) The marketing status values are defined as follows:

ACTIVE: Product device recommended for new designs.

LIFEBUY: TI has announced that the device will be discontinued, and a lifetime-buy period is in effect.

NRND: Not recommended for new designs. Device is in production to support existing customers, but TI does not recommend using this part in a new design.

PREVIEW: Device has been announced but is not in production. Samples may or may not be available.

OBSELETE: TI has discontinued the production of the device.

(2) **RoHS:** TI defines "RoHS" to mean semiconductor products that are compliant with the current EU RoHS requirements for all 10 RoHS substances, including the requirement that RoHS substance do not exceed 0.1% by weight in homogeneous materials. Where designed to be soldered at high temperatures, "RoHS" products are suitable for use in specified lead-free processes. TI may reference these types of products as "Pb-Free".

RoHS Exempt: TI defines "RoHS Exempt" to mean products that contain lead but are compliant with EU RoHS pursuant to a specific EU RoHS exemption.

Green: TI defines "Green" to mean the content of Chlorine (Cl) and Bromine (Br) based flame retardants meet JS709B low halogen requirements of <=1000ppm threshold. Antimony trioxide based flame retardants must also meet the <=1000ppm threshold requirement.

(3) MSL, Peak Temp. - The Moisture Sensitivity Level rating according to the JEDEC industry standard classifications, and peak solder temperature.

(4) There may be additional marking, which relates to the logo, the lot trace code information, or the environmental category on the device.

(5) Multiple Device Markings will be inside parentheses. Only one Device Marking contained in parentheses and separated by a "-" will appear on a device. If a line is indented then it is a continuation of the previous line and the two combined represent the entire Device Marking for that device.

(6) Lead finish/Ball material - Orderable Devices may have multiple material finish options. Finish options are separated by a vertical ruled line. Lead finish/Ball material values may wrap to two lines if the finish value exceeds the maximum column width.

Important Information and Disclaimer:The information provided on this page represents TI's knowledge and belief as of the date that it is provided. TI bases its knowledge and belief on information provided by third parties, and makes no representation or warranty as to the accuracy of such information. Efforts are underway to better integrate information from third parties. TI has taken and continues to take reasonable steps to provide representative and accurate information but may not have conducted destructive testing or chemical analysis on incoming materials and chemicals. TI and TI suppliers consider certain information to be proprietary, and thus CAS numbers and other limited information may not be available for release.

In no event shall TI's liability arising out of such information exceed the total purchase price of the TI part(s) at issue in this document sold by TI to Customer on an annual basis.

TAPE AND REEL INFORMATION



QUADRANT ASSIGNMENTS FOR PIN 1 ORIENTATION IN TAPE



*All dimensions are nominal

Device	Package Type	Package Drawing	Pins	SPQ	Reel Diameter (mm)	Reel Width W1 (mm)	A0 (mm)	B0 (mm)	K0 (mm)	P1 (mm)	W (mm)	Pin1 Quadrant
UCC27212AQDDARQ1	SO PowerPAD	DDA	8	2500	330.0	12.8	6.4	5.2	2.1	8.0	12.0	Q1

TAPE AND REEL BOX DIMENSIONS

*All dimensions are nominal

Device	Package Type	Package Drawing	Pins	SPQ	Length (mm)	Width (mm)	Height (mm)
UCC27212AQDDARQ1	SO PowerPAD	DDA	8	2500	366.0	364.0	50.0



Images above are just a representation of the package family, actual package may vary.
Refer to the product data sheet for package details.

DDA (R-PDSO-G8)

PowerPAD™ PLASTIC SMALL-OUTLINE



- NOTES:
- A. All linear dimensions are in millimeters. Dimensioning and tolerancing per ASME Y14.5-1994.
 - B. This drawing is subject to change without notice.
 - C. Body dimensions do not include mold flash or protrusion not to exceed 0,15.
 - D. This package is designed to be soldered to a thermal pad on the board. Refer to Technical Brief, PowerPad Thermally Enhanced Package, Texas Instruments Literature No. SLMA002 for information regarding recommended board layout. This document is available at www.ti.com <<http://www.ti.com>>.
 - E. See the additional figure in the Product Data Sheet for details regarding the exposed thermal pad features and dimensions.
 - F. This package complies to JEDEC MS-012 variation BA

PowerPAD is a trademark of Texas Instruments.

DDA (R-PDSO-G8)

PowerPAD™ PLASTIC SMALL OUTLINE

THERMAL INFORMATION

This PowerPAD™ package incorporates an exposed thermal pad that is designed to be attached to a printed circuit board (PCB). The thermal pad must be soldered directly to the PCB. After soldering, the PCB can be used as a heatsink. In addition, through the use of thermal vias, the thermal pad can be attached directly to the appropriate copper plane shown in the electrical schematic for the device, or alternatively, can be attached to a special heatsink structure designed into the PCB. This design optimizes the heat transfer from the integrated circuit (IC).

For additional information on the PowerPAD package and how to take advantage of its heat dissipating abilities, refer to Technical Brief, PowerPAD Thermally Enhanced Package, Texas Instruments Literature No. SLMA002 and Application Brief, PowerPAD Made Easy, Texas Instruments Literature No. SLMA004. Both documents are available at www.ti.com.

The exposed thermal pad dimensions for this package are shown in the following illustration.



Exposed Thermal Pad Dimensions

4206322-6/L 05/12

NOTE: A. All linear dimensions are in millimeters

PowerPAD is a trademark of Texas Instruments



- NOTES:
- A. All linear dimensions are in millimeters.
 - B. This drawing is subject to change without notice.
 - C. Publication IPC-7351 is recommended for alternate designs.
 - D. This package is designed to be soldered to a thermal pad on the board. Refer to Technical Brief, PowerPad Thermally Enhanced Package, Texas Instruments Literature No. SLMA002, SLMA004, and also the Product Data Sheets for specific thermal information, via requirements, and recommended board layout. These documents are available at www.ti.com <<http://www.ti.com>>. Publication IPC-7351 is recommended for alternate designs.
 - E. Laser cutting apertures with trapezoidal walls and also rounding corners will offer better paste release. Customers should contact their board assembly site for stencil design recommendations. Example stencil design based on a 50% volumetric metal load solder paste. Refer to IPC-7525 for other stencil recommendations.
 - F. Customers should contact their board fabrication site for solder mask tolerances between and around signal pads.

PowerPAD is a trademark of Texas Instruments.

IMPORTANT NOTICE AND DISCLAIMER

TI PROVIDES TECHNICAL AND RELIABILITY DATA (INCLUDING DATA SHEETS), DESIGN RESOURCES (INCLUDING REFERENCE DESIGNS), APPLICATION OR OTHER DESIGN ADVICE, WEB TOOLS, SAFETY INFORMATION, AND OTHER RESOURCES "AS IS" AND WITH ALL FAULTS, AND DISCLAIMS ALL WARRANTIES, EXPRESS AND IMPLIED, INCLUDING WITHOUT LIMITATION ANY IMPLIED WARRANTIES OF MERCHANTABILITY, FITNESS FOR A PARTICULAR PURPOSE OR NON-INFRINGEMENT OF THIRD PARTY INTELLECTUAL PROPERTY RIGHTS.

These resources are intended for skilled developers designing with TI products. You are solely responsible for (1) selecting the appropriate TI products for your application, (2) designing, validating and testing your application, and (3) ensuring your application meets applicable standards, and any other safety, security, regulatory or other requirements.

These resources are subject to change without notice. TI grants you permission to use these resources only for development of an application that uses the TI products described in the resource. Other reproduction and display of these resources is prohibited. No license is granted to any other TI intellectual property right or to any third party intellectual property right. TI disclaims responsibility for, and you will fully indemnify TI and its representatives against, any claims, damages, costs, losses, and liabilities arising out of your use of these resources.

TI's products are provided subject to [TI's Terms of Sale](#) or other applicable terms available either on [ti.com](https://www.ti.com) or provided in conjunction with such TI products. TI's provision of these resources does not expand or otherwise alter TI's applicable warranties or warranty disclaimers for TI products.

TI objects to and rejects any additional or different terms you may have proposed.

Mailing Address: Texas Instruments, Post Office Box 655303, Dallas, Texas 75265
Copyright © 2024, Texas Instruments Incorporated