

TPS748A-Q1 Automotive, 1.5-A, Low-Dropout Linear Regulator With Programmable Soft-Start

1 Features

- AEC-Q100 qualified for automotive applications:
 - Temperature grade 1: $-40^{\circ}\text{C} \leq T_A \leq +125^{\circ}\text{C}$
 - HBM ESD classification level 2
 - CDM ESD classification level C4A
- Extended junction temperature (T_J) range:
 - -40°C to $+150^{\circ}\text{C}$
- Input voltage range:
 - IN: $V_{IN} + V_{DO}$ to 6.0 V
 - BIAS: $V_{OUT} + V_{DO(BIAS)}$ to 6.0 V
- V_{OUT} range: 0.8 V to 3.6 V
- Low dropout: 60 mV typical at 1.5 A, $V_{BIAS} = 5$ V
- Power-good (PG) output allows supply monitoring or provides a sequencing signal for other supplies
- 2% accuracy over line, load, and temperature
- Programmable soft-start provides linear voltage start-up
- V_{BIAS} permits low V_{IN} operation with good transient response
- Stable with any output capacitor ≥ 2.2 μF
- Available in small, 3-mm \times 3-mm \times 1-mm VSON-10 packages

2 Applications

- [Telematic control units](#)
- [Infotainment and clusters](#)
- [Imaging radar](#)

3 Description

The TPS748A-Q1 low-dropout (LDO) linear regulator provides an easy-to-use robust power management solution for a wide variety of applications. User-programmable soft-start minimizes stress on the input power source by reducing capacitive inrush current on start-up. The soft-start is monotonic and designed for powering many different types of processors and application-specific integrated circuits (ASICs). The enable input and power-good output allow easy sequencing with external regulators. This complete flexibility enables a solution to be configured that meets the sequencing requirements of field-programmable gate arrays (FPGAs), digital signal processors (DSPs), and other applications with special start-up requirements.

A precision reference and error amplifier deliver 2% accuracy over load, line, temperature, and process. The device is stable with any type of capacitor greater than or equal to 2.2 μF , and is fully specified for $T_J = -40^{\circ}\text{C}$ to $+150^{\circ}\text{C}$. The TPS748A-Q1 is offered in a small, 3-mm \times 3-mm, VSON-10 package, yielding a highly compact, total solution size.

Package Information

PART NUMBER	PACKAGE ⁽¹⁾	PACKAGE SIZE ⁽²⁾
TPS748A-Q1	DRC (VSON,10)	3.00 mm \times 3.00 mm

- (1) For all available packages, see the orderable addendum at the end of the data sheet.
- (2) The package size (length \times width) is a nominal value and includes pins, where applicable.

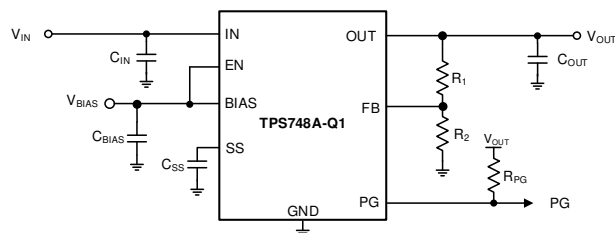

Typical Application Circuit (Adjustable)

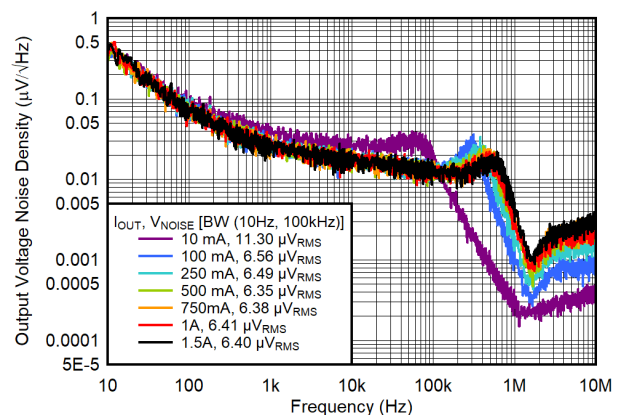

Output Voltage Noise Density vs Frequency



Table of Contents

1 Features	1	7.3 Feature Description.....	11
2 Applications	1	7.4 Device Functional Modes.....	15
3 Description	1	8 Application and Implementation	16
4 Revision History	2	8.1 Application Information.....	16
5 Pin Configuration and Functions	3	8.2 Typical Application.....	20
6 Specifications	4	8.3 Power Supply Recommendations.....	21
6.1 Absolute Maximum Ratings.....	4	8.4 Layout.....	21
6.2 ESD Ratings.....	4	9 Device and Documentation Support	24
6.3 Recommended Operating Conditions.....	4	9.1 Receiving Notification of Documentation Updates....	24
6.4 Thermal Information.....	5	9.2 Support Resources.....	24
6.5 Electrical Characteristics.....	5	9.3 Trademarks.....	24
6.6 Typical Characteristics: I _{OUT} = 50 mA.....	7	9.4 Electrostatic Discharge Caution.....	24
7 Detailed Description	11	9.5 Glossary.....	24
7.1 Overview.....	11	10 Mechanical, Packaging, and Orderable Information	24
7.2 Functional Block Diagram.....	11		

4 Revision History

NOTE: Page numbers for previous revisions may differ from page numbers in the current version.

Changes from Revision * (December 2022) to Revision A (May 2023)	Page
• Changed document status from <i>Advance Information</i> to <i>Production Data</i>	1

5 Pin Configuration and Functions

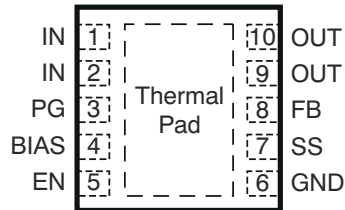

Figure 5-1. DRC Package, 10-Pin VSON With Thermal Pad (Top View)

Table 5-1. Pin Functions

PIN		TYPE	DESCRIPTION
NAME	VSON		
BIAS	4	I	Bias input voltage for the error amplifier, reference, and internal control circuits. Use a 1- μ F or larger input capacitor for optimal performance. If IN is connected to BIAS, a 4.7- μ F or larger capacitor must be used.
EN	5	I	Enable pin. Driving this pin high enables the regulator. Driving this pin low puts the regulator into shutdown mode. This pin must not be left unconnected.
FB	8	I	Feedback pin. This pin is the feedback connection to the center tap of an external resistor divider network that sets the output voltage. This pin must not be left floating.
GND	6	—	Ground
IN	1, 2	I	Input to the device. Use a 1- μ F or larger input capacitor for optimal performance.
NC	N/A	—	No connection. This pin can be left floating or connected to GND to allow better thermal contact to the top-side plane.
OUT	9, 10	O	Regulated output voltage. A small capacitor (total typical capacitance $\geq 2.2 \mu$ F, ceramic) is needed from this pin to ground to assure stability.
PG	3	O	Power-good pin. An open-drain, active-high output that indicates the status of V_{OUT} . When V_{OUT} exceeds the PG trip threshold, the PG pin goes into a high-impedance state. When V_{OUT} is below this threshold the pin is driven to a low-impedance state. Connect a pullup resistor (10 k Ω to 1 M Ω) from this pin to a supply of up to 6.0 V. The supply can be higher than the input voltage. Alternatively, the PG pin can be left unconnected if output monitoring is not necessary.
SS	7	—	Soft-start pin. A capacitor connected on this pin to ground sets the start-up time. If this pin is left unconnected, the regulator output soft-start ramp time is typically 200 μ s.
Thermal pad		—	Must be soldered to the ground plane for increased thermal performance. Internally connected to ground.

6 Specifications

6.1 Absolute Maximum Ratings

over operating temperature range (unless otherwise noted)⁽¹⁾

		MIN	MAX	UNIT
Voltage	IN, BIAS	-0.3	6.5	V
	EN	-0.3	6.5	
	PG	-0.3	6.5	
	SS	-0.3	6.5	
	FB	-0.3	V_{BIAS}	
	OUT	-0.3	$V_{IN} + 0.3$	
Current	PG	0	1.5	mA
	OUT	Internally limited		
	Output short-circuit duration	Indefinite		
	Continuous total power dissipation, P_{DISS}	See Thermal Information		
Temperature	Junction, T_J	-40	150	°C
	Storage, T_{stg}	-55	150	

- (1) Stresses beyond those listed under Absolute Maximum Ratings may cause permanent damage to the device. These are stress ratings only, which do not imply functional operation of the device at these or any other conditions beyond those indicated under Recommended Operating Conditions. Exposure to absolute-maximum-rated conditions for extended periods may affect device reliability.

6.2 ESD Ratings

		VALUE	UNIT
$V_{(ESD)}$	Electrostatic discharge	Human body model (HBM), per AEC Q100-002 ⁽¹⁾	±2000
		Charged device model (CDM), per AEC specification Q100-011	±500

- (1) AEC Q100-002 indicates that HBM stressing shall be in accordance with the ANSI/ESDA/JEDEC JS-001 specification.

6.3 Recommended Operating Conditions

over operating free-air temperature range (unless otherwise noted)

		MIN	NOM	MAX	UNIT
V_{IN}	Input supply voltage	$V_{OUT} + V_{DO}$ (V_{IN})	$V_{OUT} + 0.3$	6.0	V
V_{EN}	Enable supply voltage		V_{IN}	6.0	V
V_{BIAS}	BIAS supply voltage	$V_{OUT} + V_{DO}$ (V_{BIAS}) ⁽¹⁾	$V_{OUT} + 1.6$ ⁽¹⁾	6.0	V
V_{OUT}	Output voltage	0.8		3.3	V
I_{OUT}	Output current	0		1.5	A
C_{OUT}	Output capacitor ⁽³⁾	10			µF
C_{IN}	Input capacitor ^{(1) (2)}	1			µF
C_{BIAS}	Bias capacitor	0.1	1		µF
C_{SS}	Soft-start capacitor	1	10	100	nF
T_J	Operating junction temperature	-40		150	°C

- (1) V_{BIAS} has a minimum voltage of 2.7 V or $V_{OUT} + V_{DO}$ (V_{BIAS}), whichever is higher.
(2) If V_{IN} and V_{BIAS} are connected to the same supply, the recommended minimum capacitor for the supply is 4.7 µF.
(3) A maximum capacitor derating of 25% is considered for minimum capacitance

6.4 Thermal Information

THERMAL METRIC ⁽¹⁾		TPS748A-Q1	UNIT
		DRC (VSON)	
		10 PINS	
R _{θJA}	Junction-to-ambient thermal resistance	47.2	°C/W
R _{θJC(top)}	Junction-to-case (top) thermal resistance	63.7	°C/W
R _{θJB}	Junction-to-board thermal resistance	19.5	°C/W
ψ _{JT}	Junction-to-top characterization parameter	4.2	°C/W
ψ _{JB}	Junction-to-board characterization parameter	19.4	°C/W
R _{θJC(bot)}	Junction-to-case (bottom) thermal resistance	3.3	°C/W

(1) For more information about traditional and new thermal metrics, see the [Semiconductor and IC package thermal metrics application report](#).

6.5 Electrical Characteristics

At V_{EN} = 1.1 V, V_{IN} = V_{OUT} + 0.3 V, C_{BIAS} = 0.1 μF, C_{IN} = C_{OUT} = 10 μF, C_{SS} = 1 nF, I_{OUT} = 50 mA, V_{BIAS} = 5.0 V⁽⁴⁾, and T_J = –40°C to 150°C, (unless otherwise noted); typical values are at T_J = 25°C

PARAMETER		TEST CONDITIONS	MIN	TYP	MAX	UNIT
V _{IN}	Input voltage range		V _{OUT} + V _{DO}		6.0	V
V _{BIAS}	BIAS pin voltage range		2.7		6.0	V
V _{REF}	Internal reference (Adj.)	T _A = +25°C	0.796	0.8	0.804	V
V _{BIAS(UVLO)}	Rising bias supply UVLO		1.0	1.25	1.75	V
V _{BIAS(UVLO)} , HYST	Bias supply UVLO hysteresis		20	43	65	mV
ΔV _{OUT} (ΔVIN)	Output voltage range	V _{IN} = 5 V, I _{OUT} = 1.5 A	V _{REF}		3.6	V
	Accuracy ^{(1) (5)}	2.97 V ≤ V _{BIAS} ≤ 5.5 V, 50 mA ≤ I _{OUT} ≤ 1.5 A	–1.25	±0.5	1.25	%
ΔV _{OUT} (ΔIOUT)	Line regulation	V _{OUT(nom)} + 0.3 ≤ V _{IN} ≤ 5.5 V		0.03		%/V
V _{OUT}	Load regulation	50 mA ≤ I _{OUT} ≤ 1.5 A		0.09		%/A
V _{DO(IN)}	V _{IN} dropout voltage ⁽²⁾	I _{OUT} = 1.5 A, V _{BIAS} – V _{OUT(nom)} ≥ 3.25 V ⁽³⁾		75	150	mV
V _{DO(BIAS)}	V _{BIAS} dropout voltage ⁽²⁾	I _{OUT} = 1.5 A, V _{IN} = V _{BIAS}		1.14	1.35	V
I _{CL}	Output current limit	V _{OUT} = 80% × V _{OUT(nom)}	2.3		3.1	A
I _{BIAS}	BIAS pin current	I _{OUT} = 50 mA		0.67	1.1	mA
I _{SHDN}	Shutdown supply current (I _{GND})	V _{EN} ≤ 0.4 V, V _{IN} = 1.1 V, V _{OUT} = 0.8 V		0.9	15	μA
I _{FB}	Feedback pin current		–0.22	±0.12	0.22	μA
PSRR	Power-supply rejection (V _{IN} to V _{OUT})	1 kHz, I _{OUT} = 1.5 A, V _{IN} = 1.1 V, V _{OUT} = 0.8 V		69		dB
		300 kHz, I _{OUT} = 1.5 A, V _{IN} = 1.1 V, V _{OUT} = 0.8 V		30		dB
	Power-supply rejection (V _{BIAS} to V _{OUT})	1 kHz, I _{OUT} = 1.5 A, V _{IN} = 1.1 V, V _{OUT} = 0.8 V		59		dB
		300 kHz, I _{OUT} = 1.5 A, V _{IN} = 1.1 V, V _{OUT} = 0.8 V		33		dB
V _n	Output noise voltage	BW = 100 Hz to 100 kHz, I _{OUT} = 1.5 A, C _{SS} = 1 nF		7		μVrms × V _{out}
t _{STR}	Minimum startup time	R _{LOAD} for I _{OUT} = 1.0 A, C _{SS} = open		170		μs
I _{SS}	Soft-start charging current	V _{SS} = 0.4 V		7.5		μA
t _{SS}	Soft-start time	C _{SS} = 10 nF		1.2		ms
V _{EN(hi)}	Enable input high level		1.1		5.5	V
V _{EN(lo)}	Enable input low level		0		0.4	V
V _{EN(hys)}	Enable pin hysteresis			55		mV
V _{EN(dg)}	Enable pin deglitch time			17		μs

6.5 Electrical Characteristics (continued)

At $V_{EN} = 1.1\text{ V}$, $V_{IN} = V_{OUT} + 0.3\text{ V}$, $C_{BIAS} = 0.1\text{ }\mu\text{F}$, $C_{IN} = C_{OUT} = 10\text{ }\mu\text{F}$, $C_{SS} = 1\text{ nF}$, $I_{OUT} = 50\text{ mA}$, $V_{BIAS} = 5.0\text{ V}$ (4), and $T_J = -40^\circ\text{C}$ to 150°C , (unless otherwise noted); typical values are at $T_J = 25^\circ\text{C}$

PARAMETER		TEST CONDITIONS	MIN	TYP	MAX	UNIT
I_{EN}	Enable pin current	$V_{EN} = 5\text{ V}$		0.1	0.3	μA
V_{IT}	PG trip threshold	V_{OUT} decreasing	85	90	94	$\%V_{OUT}$
V_{HYS}	PG trip hysteresis			2.5		$\%V_{OUT}$
$V_{PG(lo)}$	PG output low voltage	$I_{PG} = 1\text{ mA}$ (sinking), $V_{OUT} < V_{IT}$			0.125	V
$I_{PG(ikg)}$	PG leakage current	$V_{PG} = 5.25\text{ V}$, $V_{OUT} > V_{IT}$		0.01	0.1	μA
T_J	Operating junction temperature		-40		125	$^\circ\text{C}$
T_{SD}	Thermal shutdown temperature	Shutdown, temperature increasing		165		$^\circ\text{C}$
		Reset, temperature decreasing		140		

- (1) Adjustable devices tested at 0.8 V; resistor tolerance is not taken into account.
- (2) Dropout is defined as the voltage from V_{IN} to V_{OUT} when V_{OUT} is 3% below nominal.
- (3) 3.25 V is a test condition of this device and can be adjusted by referring to Figure 12.
- (4) $V_{BIAS} = V_{DO_MAX(BIAS)} + V_{OUT}$ for $V_{OUT} \geq 3.4\text{ V}$
- (5) The device is not tested under conditions where $V_{IN} > V_{OUT} + 1.65\text{ V}$ and $I_{OUT} = 1.5\text{ A}$, because the power dissipation is higher than the maximum rating of the package. Also, this accuracy specification does not apply on any application condition that exceeds the power dissipation limit of the package under test.

6.6 Typical Characteristics: $I_{OUT} = 50\text{ mA}$

at $T_J = 25^\circ\text{C}$, $V_{IN} = V_{OUT(nom)} + 0.3\text{ V}$, $V_{BIAS} = 5\text{ V}$, $I_{OUT} = 50\text{ mA}$, $V_{EN} = V_{IN}$, $C_{IN} = 1\text{ }\mu\text{F}$, $C_{BIAS} = 4.7\text{ }\mu\text{F}$, and $C_{OUT} = 10\text{ }\mu\text{F}$ (unless otherwise noted)

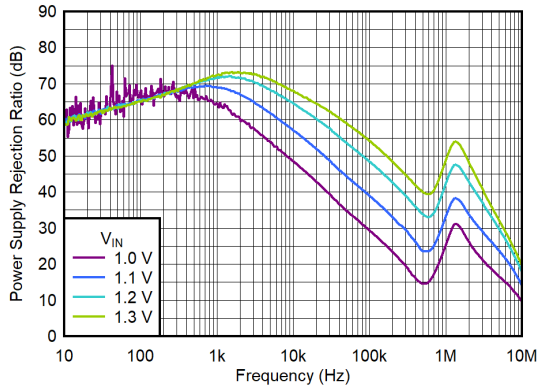

$V_{OUT} = 0.8\text{ V}$, $I_{OUT} = 1.5\text{ A}$, $C_{BIAS} = 0.1\text{ }\mu\text{F}$, $C_{OUT} = 10\text{ }\mu\text{F}$,
 $C_{SS} = 10\text{ nF}$, $V_{EN} = V_{BIAS} = 6\text{ V}$

Figure 6-1. IN PSRR vs Frequency and V_{IN}

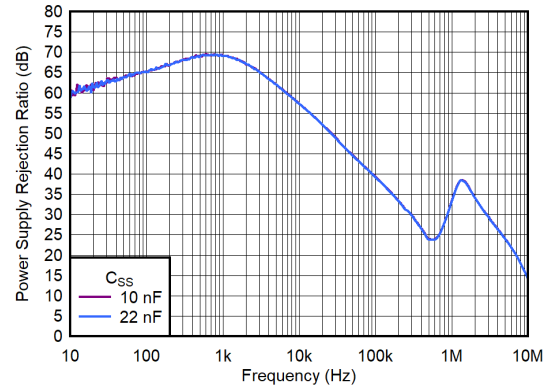

$V_{IN} = 1.1\text{ V}$, $V_{OUT} = 0.8\text{ V}$, $I_{OUT} = 1.5\text{ A}$, $C_{BIAS} = 0.1\text{ }\mu\text{F}$,
 $C_{OUT} = 10\text{ }\mu\text{F}$, $V_{EN} = V_{BIAS} = 6\text{ V}$

Figure 6-2. IN PSRR vs Frequency and C_{SS}

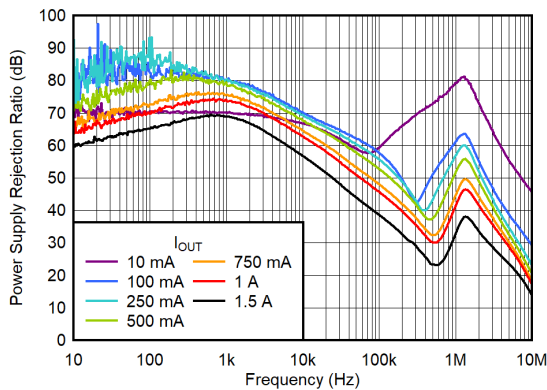

$V_{IN} = 1.1\text{ V}$, $V_{OUT} = 0.8\text{ V}$, $C_{BIAS} = 0.1\text{ }\mu\text{F}$, $C_{OUT} = 10\text{ }\mu\text{F}$,
 $C_{SS} = 10\text{ nF}$, $V_{EN} = V_{BIAS} = 6\text{ V}$

Figure 6-3. IN PSRR vs Frequency and I_{OUT} for $V_{OUT} = 0.8\text{ V}$

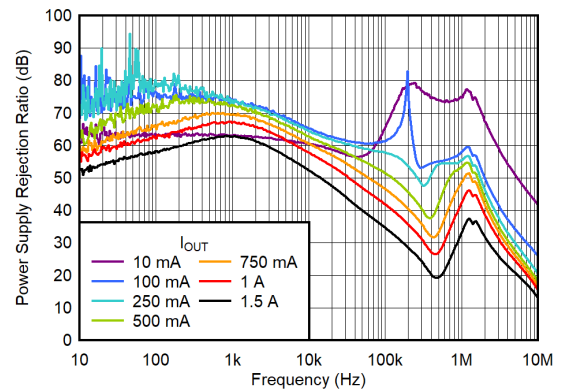

$V_{IN} = 2.1\text{ V}$, $V_{OUT} = 1.8\text{ V}$, $C_{BIAS} = 0.1\text{ }\mu\text{F}$, $C_{OUT} = 10\text{ }\mu\text{F}$,
 $C_{SS} = 10\text{ nF}$, $V_{EN} = V_{BIAS} = 6\text{ V}$

Figure 6-4. PSRR vs Frequency and I_{OUT} for $V_{OUT} = 1.8\text{ V}$

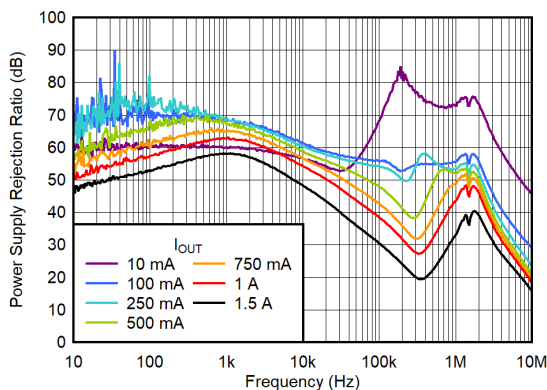

$V_{IN} = 3.6\text{ V}$, $V_{OUT} = 3.3\text{ V}$, $C_{BIAS} = 0.1\text{ }\mu\text{F}$, $C_{OUT} = 10\text{ }\mu\text{F}$,
 $C_{SS} = 10\text{ nF}$, $V_{EN} = V_{BIAS} = 6\text{ V}$

Figure 6-5. IN PSRR vs Frequency and I_{OUT} for $V_{OUT} = 3.3\text{ V}$

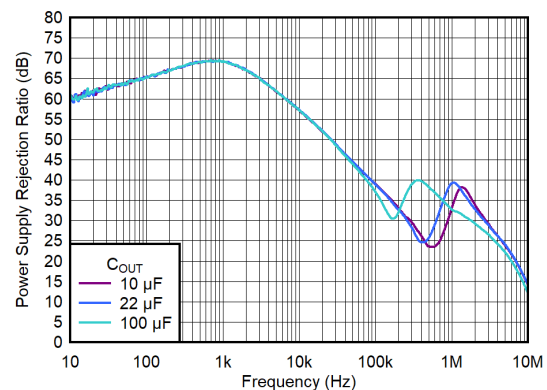

$V_{IN} = 1.1\text{ V}$, $V_{OUT} = 0.8\text{ V}$, $I_{OUT} = 1.5\text{ A}$, $C_{BIAS} = 0.1\text{ }\mu\text{F}$,
 $C_{SS} = 10\text{ nF}$, $V_{EN} = V_{BIAS} = 6\text{ V}$

Figure 6-6. IN PSRR vs Frequency and C_{OUT}

6.6 Typical Characteristics: I_{OUT} = 50 mA (continued)

at T_J = 25°C, V_{IN} = V_{OUT(nom)} + 0.3 V, V_{BIAS} = 5 V, I_{OUT} = 50 mA, V_{EN} = V_{IN}, C_{IN} = 1 μF, C_{BIAS} = 4.7 μF, and C_{OUT} = 10 μF (unless otherwise noted)

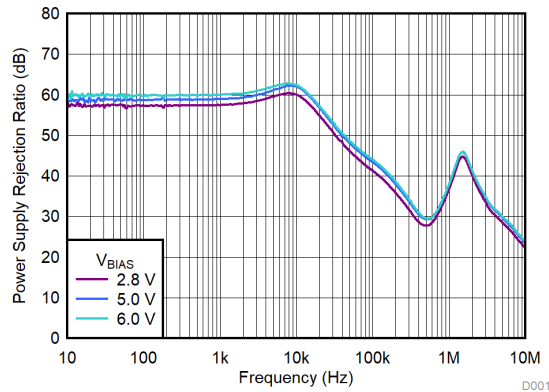

V_{IN} = 1.1 V, V_{OUT} = 0.8 V, I_{OUT} = 1.5 A, C_{IN} = 10 μF,
C_{OUT} = 10 μF, C_{SS} = 10 nF, V_{EN} = 6 V

Figure 6-7. BIAS PSRR vs Frequency and V_{BIAS}

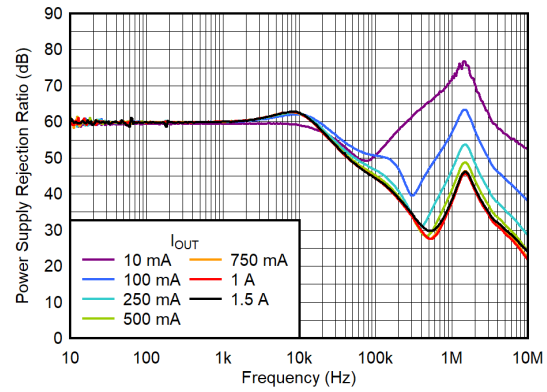

V_{EN} = V_{IN} = 1.1 V, V_{OUT} = 0.8 V, I_{OUT} = 1.5 A, C_{IN} = 10 μF,
C_{OUT} = 10 μF, C_{SS} = 10 nF, V_{BIAS} = 6 V

Figure 6-8. BIAS PSRR vs Frequency and I_{OUT}

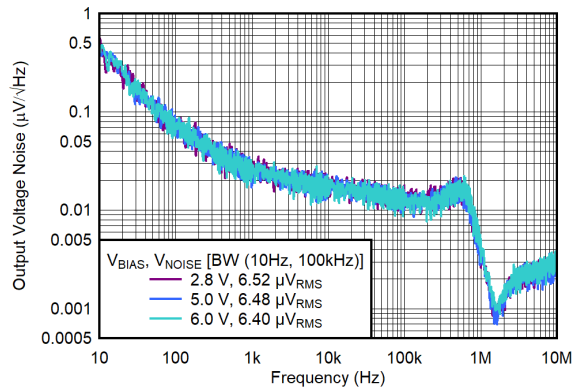

V_{EN} = V_{BIAS}, V_{IN} = 1.1 V, V_{OUT} = 0.8 V, I_{OUT} = 1.5 A,
C_{IN} = 10 μF, C_{OUT} = 10 μF, C_{SS} = 10 nF, C_{BIAS} = 0.1 μF

Figure 6-9. Output Voltage Noise Density vs Frequency and V_{BIAS}

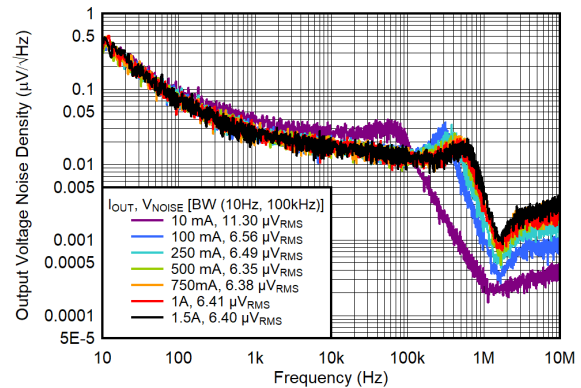

V_{EN} = V_{BIAS}, V_{IN} = 1.1 V, V_{OUT} = 0.8 V, C_{IN} = 10 μF,
C_{OUT} = 10 μF, C_{SS} = 10 nF, C_{BIAS} = 0.1 μF

Figure 6-10. Output Voltage Noise Density vs Frequency and I_{OUT}

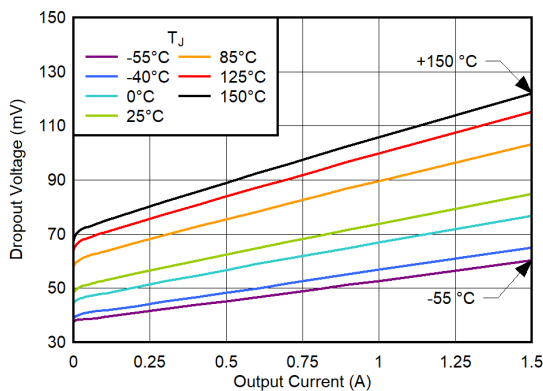

V_{BIAS} = 5 V, V_{OUT} = 0.8 V

Figure 6-11. IN-to-OUT Dropout Voltage vs I_{OUT} and Temperature (T_J)

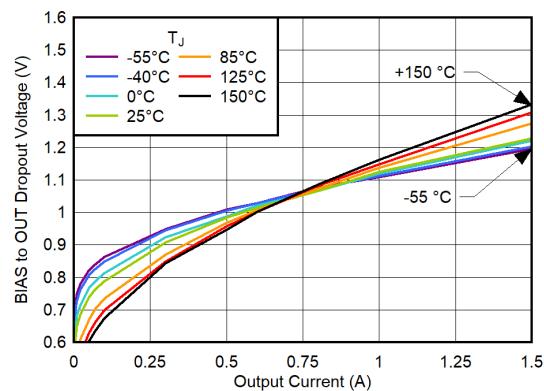

V_{IN} = 1.1 V, V_{OUT} = 0.8 V

Figure 6-12. BIAS-to-OUT Dropout Voltage vs I_{OUT} and Temperature (T_J)

6.6 Typical Characteristics: I_{OUT} = 50 mA (continued)

at T_J = 25°C, V_{IN} = V_{OUT(nom)} + 0.3 V, V_{BIAS} = 5 V, I_{OUT} = 50 mA, V_{EN} = V_{IN}, C_{IN} = 1 μF, C_{BIAS} = 4.7 μF, and C_{OUT} = 10 μF (unless otherwise noted)

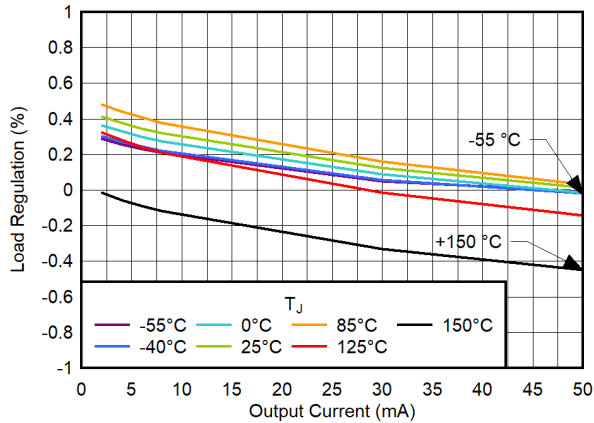

V_{IN} = 1.1 V, V_{BIAS} = 5 V, V_{OUT} = 0.8 V

Figure 6-13. Load Regulation vs 0-mA to 50-mA Output Current

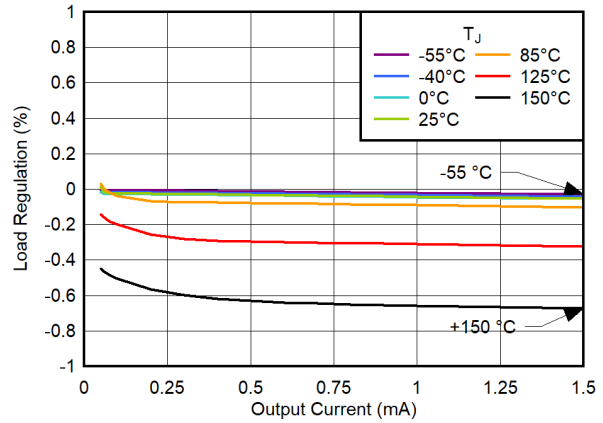

V_{IN} = 1.1 V, V_{BIAS} = 5 V, V_{OUT} = 0.8 V

Figure 6-14. Load Regulation vs ≥50-mA Output Current

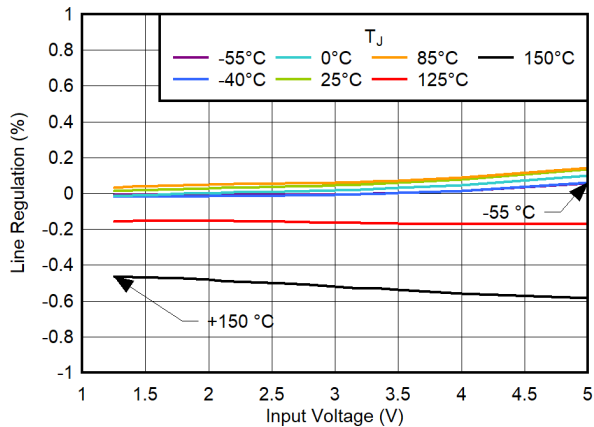

V_{OUT} = 0.8 V, V_{BIAS} = 5 V, I_{OUT} = 50 mA

Figure 6-15. Line Regulation vs Input Voltage

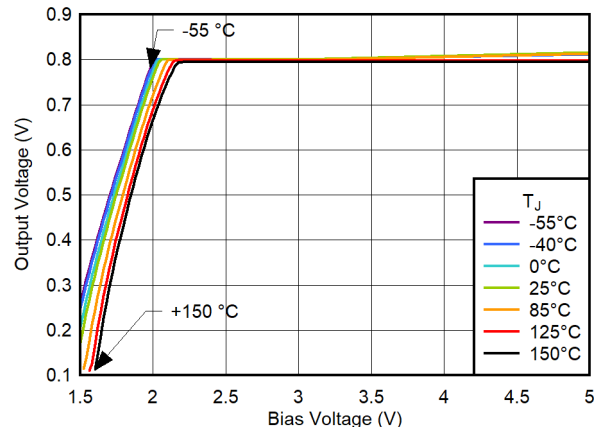

V_{BIAS} = 5 V, V_{OUT} = 0.8 V, I_{OUT} = 50 mA

Figure 6-16. Output Voltage vs Bias Voltage

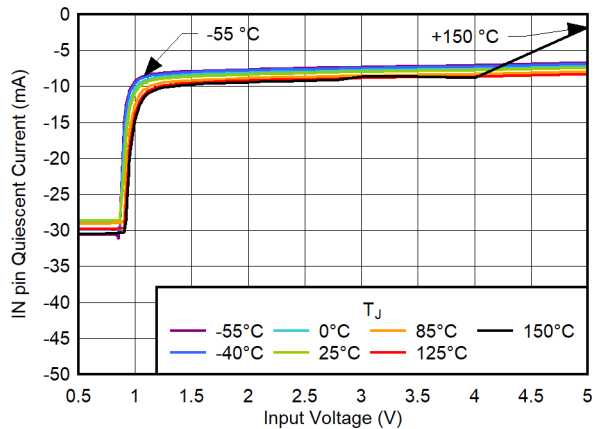

V_{OUT} = 0.8 V, V_{BIAS} = 5.0 V, I_{OUT} = 50 mA

Figure 6-17. IN Pin Quiescent Current vs Input Voltage

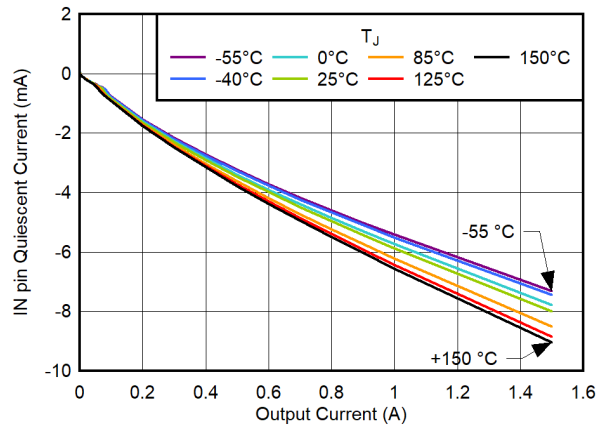

V_{OUT} = 0.8 V, V_{BIAS} = 5.0 V

Figure 6-18. IN Pin Quiescent Current vs Output Current

6.6 Typical Characteristics: I_{OUT} = 50 mA (continued)

at T_J = 25°C, V_{IN} = V_{OUT(nom)} + 0.3 V, V_{BIAS} = 5 V, I_{OUT} = 50 mA, V_{EN} = V_{IN}, C_{IN} = 1 μF, C_{BIAS} = 4.7 μF, and C_{OUT} = 10 μF (unless otherwise noted)

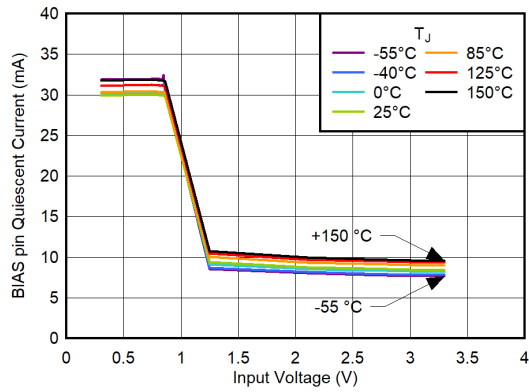

V_{OUT} = 0.8 V, V_{BIAS} = 5.0 V, I_{OUT} = 1.5 A

Figure 6-19. BIAS Pin Quiescent Current vs Input Voltage

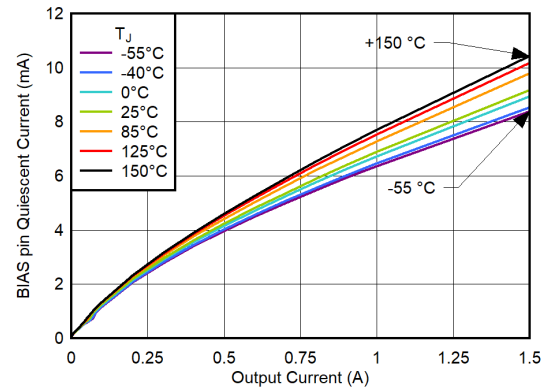

V_{IN} = 1.1 V, V_{OUT} = 0.8 V, V_{BIAS} = 5.0 V

Figure 6-20. BIAS Pin Quiescent Current vs Output Current

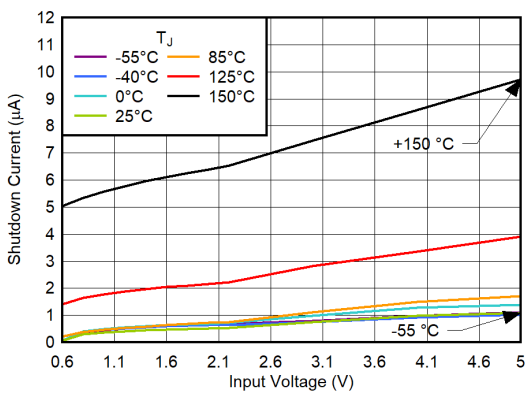

V_{BIAS} = 5 V, V_{EN} = 0 V

Figure 6-21. Shutdown Current (GND Pin) vs Input Voltage

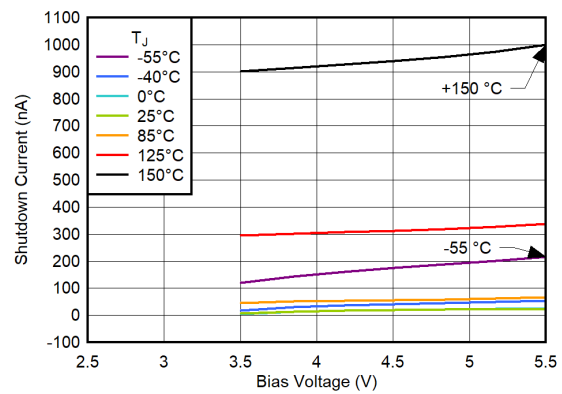

V_{IN} = 1.1 V, V_{EN} = 0 V

Figure 6-22. Shutdown Current (GND Pin) vs Bias Voltage

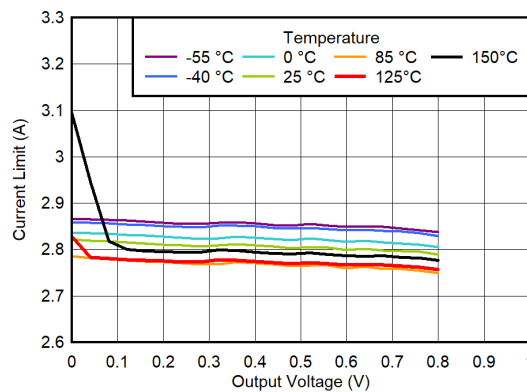

Figure 6-23. Current Limit vs Output Voltage

7 Detailed Description

7.1 Overview

The TPS748A-Q1 is a low-input, low-output (LILO), low-quiescent-current linear regulator optimized to support excellent transient performance. This regulator uses a low-current bias rail to power all internal control circuitry, allowing the n-type field effect transistor (NMOS) pass transistor to regulate very-low input and output voltages.

Using an NMOS pass transistor offers several critical advantages for many applications. Unlike a p-channel metal-oxide-semiconductor field effect transistor (PMOS) topology device, the output capacitor has little effect on loop stability. This architecture allows the TPS748A-Q1 to be stable with any ceramic capacitor 10 μF or greater. Transient response is also superior to PMOS topologies, particularly for low V_{IN} applications.

The TPS748A-Q1 features a programmable, voltage-controlled, soft-start circuit that provides a smooth, monotonic start-up and limits start-up inrush currents that can be caused by large capacitive loads. An enable (EN) pin with hysteresis and deglitch allows slow-ramping signals to be used for sequencing the device. The low V_{IN} and V_{OUT} capability allows for inexpensive, easy-to-design, and efficient linear regulation between the multiple supply voltages often required by processor-intensive systems.

7.2 Functional Block Diagram

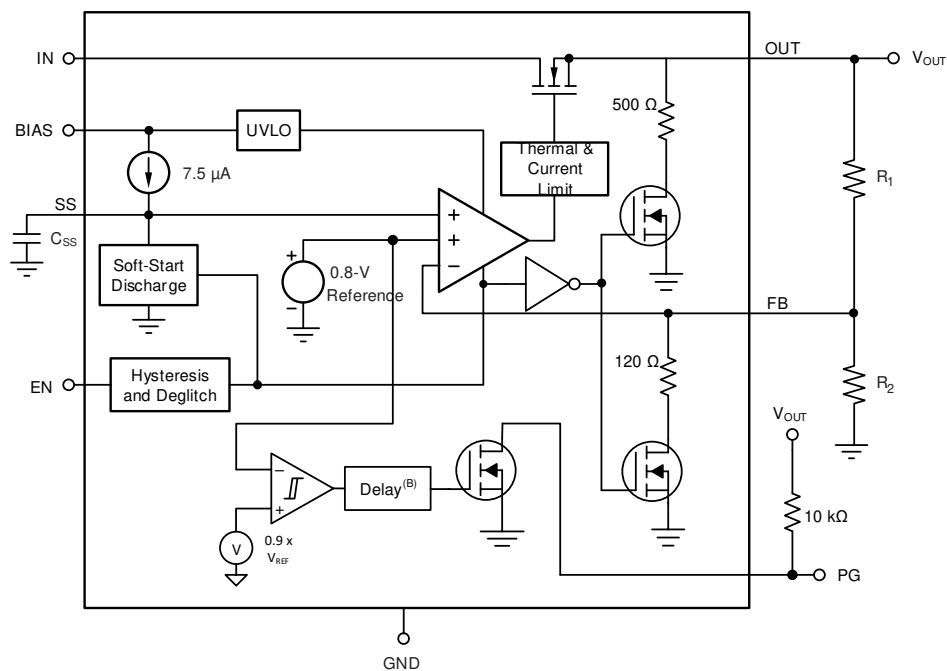

7.3 Feature Description

7.3.1 Enable and Shutdown

The enable (EN) pin is active high and compatible with standard digital-signaling levels. Setting V_{EN} below 0.4 V turns the regulator off, and setting V_{EN} above 1.1 V turns the regulator on. Unlike many regulators, the enable circuitry has hysteresis and deglitching for use with relatively slowly ramping analog signals. This configuration allows the device to be enabled by connecting the output of another supply to the EN pin. The enable circuitry typically has 70 mV of hysteresis and a deglitch circuit to help avoid on-off cycling as a result of small glitches in the V_{EN} signal.

The enable threshold is typically 0.75 V and varies with temperature and process variations. Temperature variation is approximately $-1.2 \text{ mV}/^\circ\text{C}$; process variation accounts for most of the remaining variation to the 0.4-V and 1.1-V limits. If precise turn-on timing is required, a fast rise-time signal must be used.

If not used, EN can be connected to BIAS. Place the connection as close as possible to the bias capacitor.

7.3.2 Active Discharge

The TPS748A-Q1 has an internal active pulldown circuits on the OUT pin.

Each active discharge function uses an internal metal-oxide-semiconductor field-effect transistor (MOSFET) that connects a resistor (R_{PULLDOWN}) to ground when the low-dropout resistor (LDO) is disabled in order to actively discharge the output voltage. The active discharge circuit is activated when the device is disabled by driving EN to logic low, when the voltage at IN or BIAS is below the UVLO threshold, or when the regulator is in thermal shutdown.

The discharge time after disabling the device depends on the output capacitance (C_{OUT}) and the load resistance (R_{L}) in parallel with the pulldown resistor.

The first active pulldown circuit connects the output to GND through a 600- Ω resistor when the device is disabled.

The second circuit connects FB to GND through a 120- Ω resistor when the device is disabled. This resistor discharges the FB pin. [Equation 1](#) calculates the output capacitor discharge time constant when OUT is shorted to FB, or when the output voltage is set to 0.65 V.

$$\tau_{\text{OUT}} = (600 \parallel 120 \times R_{\text{L}} / (600 \parallel 120 + R_{\text{L}}) \times C_{\text{OUT}} \quad (1)$$

If the LDO is set to an output voltage greater than 0.65 V, a resistor divider network is in place and minimizes the FB pin pulldown. [Equation 2](#) and [Equation 3](#) calculate the time constants set by these discharge resistors.

$$R_{\text{DISCHARGE}} = (120 \parallel R_2) + R_1 \quad (2)$$

$$\tau_{\text{OUT}} = R_{\text{DISCHARGE}} \times R_{\text{L}} / (R_{\text{DISCHARGE}} + R_{\text{L}}) \times C_{\text{OUT}} \quad (3)$$

Do not rely on the active discharge circuit for discharging a large amount of output capacitance after the input supply has collapsed because reverse current can flow from the output to the input and can cause damage to the device. Limit reverse current to no more than 5% of the device-rated current.

7.3.3 Power-Good Output (PG)

The PG signal provides an easy solution to meet demanding sequencing requirements because PG signals when the output nears the nominal value. PG can be used to signal other devices in a system when the output voltage is near, at, or above the set output voltage ($V_{OUT(nom)}$). [Figure 7-1](#) shows a simplified schematic.

The PG signal is an open-drain digital output that requires a pullup resistor to a voltage source and is active high. The PG circuit sets the PG pin into a high-impedance state to indicate that the power is good.

Using a large feed-forward capacitor (C_{FF}) delays the output voltage and, because the PG circuit monitors the FB pin, the PG signal can indicate a false positive.

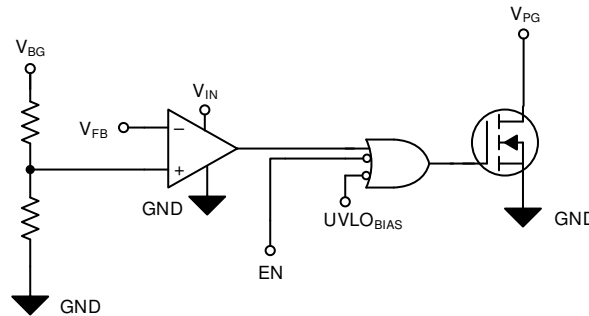

Figure 7-1. Simplified PG Circuit

7.3.4 Internal Current Limit

The device has an internal current-limit circuit that protects the regulator during transient high-load current faults or shorting events. The current limit is a hybrid brick-wall foldback scheme. The current limit transitions from a brick-wall scheme to a foldback scheme at the foldback voltage ($V_{FOLDBACK}$). In a high-load current fault with the output voltage above $V_{FOLDBACK}$, the brick-wall scheme limits the output current to the current limit (I_{CL}). When the voltage drops below $V_{FOLDBACK}$, a foldback current limit activates that scales back the current when the output voltage approaches GND. When the output is shorted, the device supplies a typical current called the *short-circuit current limit* (I_{SC}). I_{CL} and I_{SC} are listed in the [Electrical Characteristics](#) table.

For this device, $V_{FOLDBACK}$ is approximately $60\% \times V_{OUT(nom)}$.

The output voltage is not regulated when the device is in current limit. When a current-limit event occurs, the device begins to heat up because of the increase in power dissipation. When the device is in a brick-wall current limit, the pass transistor dissipates power $[(V_{IN} - V_{OUT}) \times I_{CL}]$. When the device output is shorted and the output is below $V_{FOLDBACK}$, the pass transistor dissipates power $[(V_{IN} - V_{OUT}) \times I_{SC}]$. If thermal shutdown is triggered, the device turns off. When the device sufficiently cools down, the internal thermal shutdown circuit turns the device back on. If the output current fault condition continues, the device cycles between current limit and thermal shutdown. For more information on current limits, see the [Know Your Limits application note](#). Figure 7-2 shows a diagram of the foldback current limit.

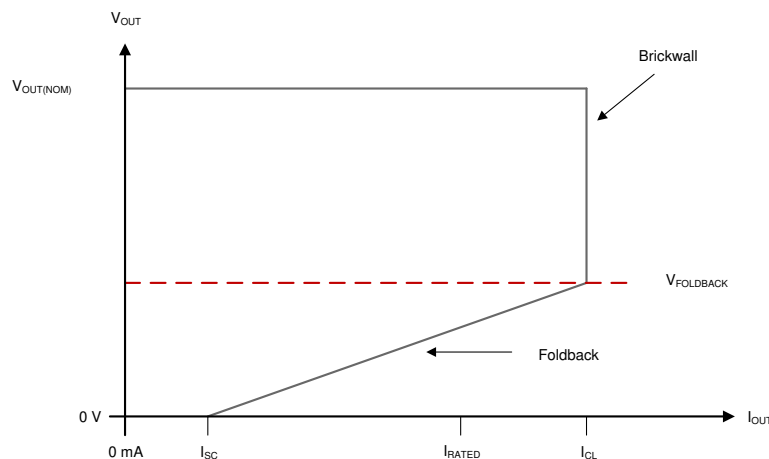

Figure 7-2. Foldback Current Limit

7.3.5 Thermal Shutdown Protection (T_{SD})

The internal thermal shutdown protection circuit disables the output when the thermal junction temperature (T_J) of the pass transistor rises to the thermal shutdown temperature threshold, $T_{SD(\text{shutdown})}$ (typical). The thermal shutdown circuit hysteresis makes sure that the LDO resets (turns on) when the temperature falls to $T_{SD(\text{reset})}$ (typical).

The thermal time constant of the semiconductor die is fairly short; thus, the device can cycle on and off when thermal shutdown is reached until the power dissipation is reduced. Power dissipation during start up can be high from large $V_{IN} - V_{OUT}$ voltage drops across the device or from high inrush currents charging large output capacitors. Under some conditions, the thermal shutdown protection disables the device before start up completes.

For reliable operation, limit the junction temperature to the maximum listed in the [Recommended Operating Conditions](#) table. Operation above this maximum temperature causes the device to exceed operational specifications. Although the internal protection circuitry is designed to protect against thermal overload conditions, this circuitry is not intended to replace proper heat sinking. Continuously running the regulator into thermal shutdown, or above the maximum recommended junction temperature, reduces long-term reliability.

7.4 Device Functional Modes

Table 7-1 shows the conditions that lead to the different modes of operation. See the [Electrical Characteristics](#) table for parameter values.

Table 7-1. Device Functional Mode Comparison

OPERATING MODE	PARAMETER				
	V _{IN}	V _{BIAS}	V _{EN}	I _{OUT}	T _J
Normal mode	$V_{IN} \geq V_{OUT(nom)} + V_{DO(IN)}$ and $V_{IN} \geq V_{IN(min)}$	$V_{BIAS} \geq V_{OUT} + V_{DO(BIAS)}$	$V_{EN} \geq V_{HI(EN)}$	$I_{OUT} < I_{CL}$	$T_J < T_{SD}$ for shutdown
Dropout mode	$V_{IN(min)} < V_{IN} < V_{OUT(nom)} + V_{DO(IN)}$	$V_{BIAS} < V_{OUT} + V_{DO(BIAS)}$	$V_{EN} > V_{HI(EN)}$	$I_{OUT} < I_{CL}$	$T_J < T_{SD}$ for shutdown
Disabled mode (any true condition disables the device)	$V_{IN} < V_{UVLO(IN)}$	$V_{BIAS} < V_{BIAS(UVLO)}$	$V_{EN} < V_{LO(EN)}$	—	$T_J \geq T_{SD}$ for shutdown

7.4.1 Normal Operation

The device regulates to the nominal output voltage when the following conditions are met:

- The input voltage is greater than the nominal output voltage plus the dropout voltage ($V_{OUT(nom)} + V_{DO(IN)}$)
- The bias voltage is greater than the nominal output voltage plus the dropout voltage ($V_{OUT(nom)} + V_{DO(BIAS)}$)
- The output current is less than the current limit ($I_{OUT} < I_{CL}$)
- The device junction temperature is less than the thermal shutdown temperature ($T_J < T_{SD(shutdown)}$)
- The enable voltage has previously exceeded the enable rising threshold voltage and has not yet decreased to less than the enable falling threshold

7.4.2 Dropout Operation

If the input voltage is lower than the nominal output voltage plus the specified dropout voltage, but all other conditions are met for normal operation, the device operates in dropout mode. Similarly, if the bias voltage is lower than the nominal output voltage plus the specified dropout voltage, but all other conditions are met for normal operation, the device operates in dropout mode as well. In this mode, the output voltage tracks the input voltage. During this mode, the transient performance of the device becomes significantly degraded because the pass transistor is in the ohmic or triode region, and functions as a switch. Line or load transients in dropout can result in large output voltage deviations.

When the device is in a steady dropout state, defined as when the device is in dropout ($V_{IN} < V_{OUT} + V_{DO(IN)}$ or $V_{BIAS} < V_{OUT} + V_{DO(BIAS)}$ directly after being in normal regulation state, but not during start up), the pass transistor is driven into the ohmic or triode region. When the input voltage returns to a value greater than or equal to the nominal output voltage plus the dropout voltage ($V_{OUT(NOM)} + V_{DO(IN)}$), the output voltage can overshoot for a short time when the device pulls the pass transistor back into the linear region.

7.4.3 Disabled

The output of the device can be shutdown by forcing the voltage of the enable pin to less than $V_{IL(EN)}$ (see the [Electrical Characteristics](#) table). When disabled, the pass transistor is turned off, internal circuits are shutdown, and the output voltage is actively discharged to ground by an internal discharge circuit from the output to ground.

The device is disabled under the following conditions:

- The input or bias voltages are below the respective minimum specifications
- The enable voltage is less than the enable falling threshold voltage or has not yet exceeded the enable rising threshold
- The device junction temperature is greater than the thermal shutdown temperature

8 Application and Implementation

Note

Information in the following applications sections is not part of the TI component specification, and TI does not warrant its accuracy or completeness. TI's customers are responsible for determining suitability of components for their purposes, as well as validating and testing their design implementation to confirm system functionality.

8.1 Application Information

The TPS748A-Q1 is a low-input, low-output (LILLO), low-dropout regulator (LDO) that features soft-start capability. This regulator uses a low-current bias input to power all internal control circuitry, allowing the NMOS pass transistor to regulate very low input and output voltages.

Using an NMOS pass transistor offers several critical advantages for many applications. Unlike a PMOS topology device, the output capacitor has little effect on loop stability. This architecture allows stability with ceramic capacitors of 10 μF or greater. Transient response is also superior to PMOS topologies, particularly for low V_{IN} applications.

A programmable voltage-controlled, soft-start circuit provides a smooth, monotonic start-up and limits start-up inrush currents that can be caused by large capacitive loads. An enable (EN) pin with hysteresis and deglitch allows slow-ramping signals to be used for sequencing the device. The low V_{IN} and V_{OUT} capability allows for inexpensive, easy-to-design, and efficient linear regulation between the multiple supply voltages often required by processor-intensive systems.

8.1.1 Input, Output, and Bias Capacitor Requirements

The device is designed to be stable for ceramic capacitor of values $\geq 10 \mu\text{F}$. The device is also stable with multiple capacitors in parallel, which can be of any type or value.

The capacitance required on the IN and BIAS pins strongly depends on the input supply source impedance. To counteract any inductance in the input, the minimum recommended capacitor for V_{IN} is 1 μF and the minimum recommended capacitor for V_{BIAS} is 0.1 μF . If V_{IN} and V_{BIAS} are connected to the same supply, the recommended minimum capacitor for V_{BIAS} is 4.7 μF . Use good quality, low equivalent series resistance (ESR) and equivalent series inductance (ESL) capacitors on the input; ceramic X5R and X7R capacitors are preferred. Place these capacitors as close the pins as possible for optimum performance.

Low ESR and ESL capacitors improve high-frequency PSRR.

8.1.2 Dropout Voltage

The TPS748A-Q1 offers very low dropout performance, making the device designed for high-current, low V_{IN} and low V_{OUT} applications. The low dropout allows the device to be used in place of a dc/dc converter and still achieve good efficiency. Equation 4 provides a quick estimate of the efficiency.

$$\text{Efficiency} \approx \frac{V_{\text{OUT}} \times I_{\text{OUT}}}{V_{\text{IN}} \times (I_{\text{IN}} + I_{\text{Q}})} \approx \frac{V_{\text{OUT}}}{V_{\text{IN}}} \text{ at } I_{\text{OUT}} \gg I_{\text{Q}} \quad (4)$$

This efficiency provides designers with the power architecture for applications to achieve the smallest, simplest, and lowest cost solutions.

For this architecture, there are two different specifications for dropout voltage. The first specification (see Figure 6-11) is referred to as V_{IN} dropout and is used when an external bias voltage is applied to achieve low dropout. This specification assumes that V_{BIAS} is at least 2.8 V above V_{OUT} , which is the case for V_{BIAS} when powered by a 5.0-V rail with 5% tolerance and with $V_{\text{OUT}} = 1.5 \text{ V}$. If V_{BIAS} is higher than $V_{\text{OUT}} + 2.8 \text{ V}$, the V_{IN} dropout is less than specified.

Note

2.8 V is a test condition of this device and can be adjusted by referring to the [Electrical Characteristics](#) table.

The second specification (illustrated in [Figure 6-12](#)) is referred to as V_{BIAS} dropout and applies to applications where IN and BIAS are tied together. This option allows the device to be used in applications where an auxiliary bias voltage is not available or low dropout is not required. Dropout is limited by BIAS in these applications because V_{BIAS} provides the gate drive to the pass transistor; therefore, V_{BIAS} must be 1.9 V above V_{OUT} . Because of this usage, having IN and BIAS tied together become a highly inefficient solution that can consume large amounts of power. Pay attention not to exceed the power rating of the device package.

8.1.3 Output Noise

The TPS748A-Q1 provides low output noise when a soft-start capacitor is used. When the device reaches the end of the soft-start cycle, the soft-start capacitor serves as a filter for the internal reference. By using a 10-nF, soft-start capacitor, the output noise is reduced by half and is typically 7.1 μV_{RMS} for a 0.8-V output (10 Hz to 100 kHz). Increasing C_{SS} has no effect on noise. Because most of the output noise is generated by the internal reference, the noise is a function of the set output voltage. [Equation 5](#) gives the RMS noise with a 10-nF, soft-start capacitor:

$$V_N(\mu V_{RMS}) = 7.1 \cdot \left(\frac{\mu V_{RMS}}{V} \right) \cdot V_{OUT}(V) \quad (5)$$

The low output noise makes this LDO a good choice for powering transceivers, phase-locked loops (PLLs), or other noise-sensitive circuitry.

8.1.4 Estimating Junction Temperature

By using the thermal metrics Ψ_{JT} and Ψ_{JB} , as shown in the [Thermal Information](#) table, the junction temperature can be estimated with corresponding formulas (given in [Equation 6](#)). For backwards compatibility, an older $\theta_{JC(top)}$ parameter is listed as well.

$$\Psi_{JT}: T_J = T_T + \Psi_{JT} \cdot P_D$$

$$\Psi_{JB}: T_J = T_B + \Psi_{JB} \cdot P_D \quad (6)$$

where:

- P_D is the power dissipation
- T_T is the temperature at the center-top of the package
- T_B is the PCB temperature measured 1 mm away from the package *on the PCB surface*

Note

Both T_T and T_B can be measured on actual application boards using a thermo-gun (an infrared thermometer).

For more information about measuring T_T and T_B , see the [Using New Thermal Metrics application note](#), available for download at www.ti.com.

For a more detailed discussion of why TI does not recommend using $\theta_{JC(top)}$ to determine thermal characteristics, see the [Using New Thermal Metrics application note](#), available for download at www.ti.com. For further information, see the [Semiconductor and IC Package Thermal Metrics application note](#), also available on the TI website.

8.1.5 Soft Start, Sequencing, and Inrush Current

Soft-start refers to the ramp-up characteristic of the output voltage during LDO turn-on after EN and UVLO achieve threshold voltage. The soft start current is fixed for fixed output voltage versions.

Although the device does not have any sequencing requirement, following the sequencing order of BIAS, IN, and EN makes sure that the soft start starts from zero.

[Figure 8-1](#) shows an example of the device behavior when the EN pin is enabled prior to having either power supply up. Under this condition, the output jumps from 0 V to approximately 0.3 V almost instantly when the IN voltage is sufficient to power the circuit.

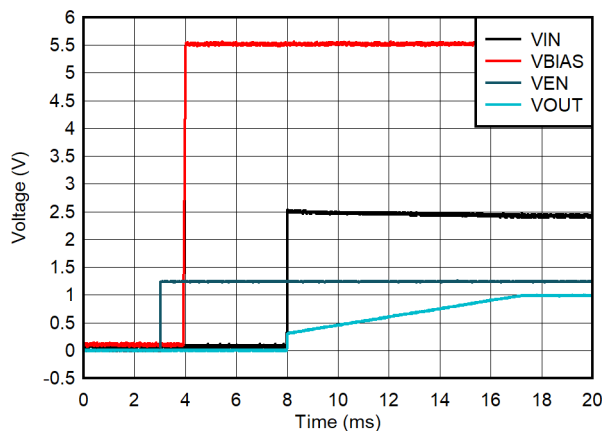

Figure 8-1. Sequencing and Soft-Start Behavior for $V_{OUT} = 1$ V

Inrush current is defined as the current into the LDO at the IN pin during start-up. Inrush current then consists primarily of the sum of load current and the current used to charge the output capacitor. This current is difficult

to measure because the input capacitor must be removed, which is not recommended. However, [Equation 7](#) can estimate this soft-start current:

$$I_{OUT(t)} = \left[\frac{C_{OUT} \times dV_{OUT}(t)}{dt} \right] + \left[\frac{V_{OUT}(t)}{R_{LOAD}} \right] \quad (7)$$

where:

- $V_{OUT}(t)$ is the instantaneous output voltage of the turn-on ramp
- $dV_{OUT}(t) / dt$ is the slope of the V_{OUT} ramp
- R_{LOAD} is the resistive load impedance

8.1.6 Power-Good Operation

For proper operation of the power-good circuit, the pullup resistor value must be between 10 k Ω and 100 k Ω . The lower limit of 10 k Ω results from the maximum pulldown strength of the power-good transistor, and the upper limit of 100 k Ω results from the maximum leakage current at the power-good node. If the pullup resistor is outside of this range, then the power-good signal can possibly not read a valid digital logic level.

The state of PG is only valid when the device operates above the minimum supply voltage. During short UVLO events and at light loads, power-good does not assert because the output voltage is sustained by the output capacitance.

8.2 Typical Application

This section discusses the implementation of the TPS748A-Q1 to regulate a 1-A load requiring good PSRR at high frequency with low noise. [Figure 8-2](#) provides a schematic for this typical application circuit.

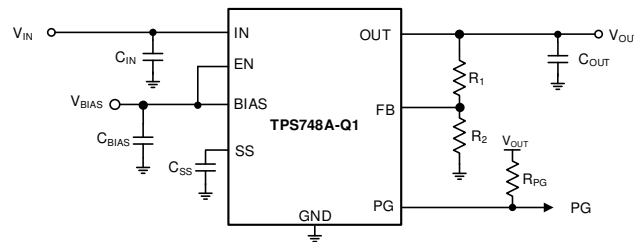

Figure 8-2. Typical ADJ Voltage Application

8.2.1 Design Requirements

For this design example, use the parameters listed in [Table 8-1](#) as the input parameters.

Table 8-1. Design Parameters

PARAMETER	DESIGN REQUIREMENT
Input voltage	2.1 V, $\pm 3\%$, provided by the dc/dc converter switching at 500 kHz
Bias voltage	5.0 V
Output voltage	1.8 V, $\pm 1\%$
Output current	1.0 A (maximum), 10 mA (minimum)
RMS noise, 10 Hz to 100 kHz	$< 10 \mu\text{V}_{\text{RMS}}$
PSRR at 500 kHz	$> 40 \text{ dB}$
Start-up time	$< 25 \text{ ms}$

8.2.2 Detailed Design Procedure

At 1.0 A and 1.8 V_{OUT} , the dropout of the TPS748A-Q1 has a 105-mV maximum dropout over temperature; thus, a 300-mV headroom is sufficient for operation over both input and output voltage accuracy. At full load and high temperature on some devices, the TPS748A can enter dropout if both the input and output supply are beyond the edges of the respective accuracy specification.

To satisfy the required start-up time and still maintain low noise performance, a 10-nF C_{SS} is selected. [Equation 8](#) calculates this value.

$$t_{\text{SS}} = (V_{\text{SS}} \times C_{\text{SS}}) / I_{\text{SS}} \quad (8)$$

At the 1.0-A maximum load, the internal power dissipation is 0.3 W and corresponds to a 13.3°C junction temperature rise for the DRC package on a standard JEDEC board. With an 55°C maximum ambient temperature, the junction temperature is at 68.3°C.

8.2.3 Application Curve

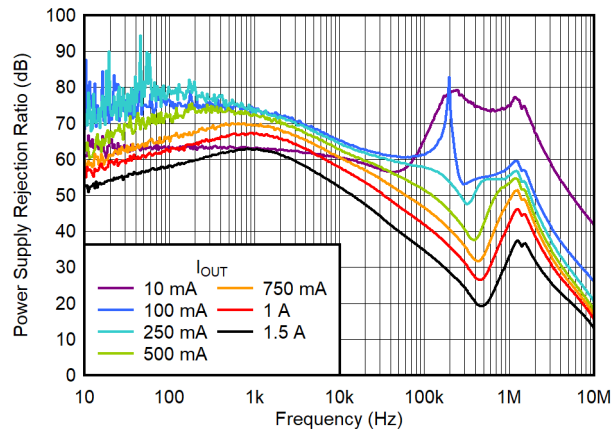

**Figure 8-3. PSRR vs Frequency for
 $V_{OUT} = 1.8\text{ V}$**

8.3 Power Supply Recommendations

The TPS748A-Q1 is designed to operate from an input voltage up to 6.0 V, provided the bias rail is at least 1.3 V higher than the input supply and dropout requirements are met. The bias rail and the input supply must both provide adequate headroom and current for the device to operate normally. Connect a low output impedance power supply directly to the IN pin. This supply must have at least 1 μF of capacitance near the IN pin for optimal performance. A supply with similar requirements must also be connected directly to the BIAS rail with a separate 0.1 μF or larger capacitor. If the IN pin is tied to the BIAS pin, a minimum 4.7- μF capacitor is required for performance. To increase the overall PSRR of the solution at higher frequencies, use a pi-filter or ferrite bead before the input capacitor.

8.4 Layout

8.4.1 Layout Guidelines

An optimal layout can greatly improve transient performance, PSRR, and noise. To minimize the voltage drop on the input of the device during load transients, the capacitance on IN and BIAS must be connected as close as possible to the device. This capacitance also minimizes the effects of parasitic inductance and resistance of the input source and can, therefore, improve stability. To achieve optimal transient performance and accuracy, the top side of R_1 in [Figure 8-2](#) must be connected as close as possible to the load. If BIAS is connected to IN, connect BIAS as close to the sense point of the input supply as possible. This connection minimizes the voltage drop on BIAS during transient conditions and can improve the turn-on response.

Knowing the device power dissipation and proper sizing of the thermal plane that is connected to the thermal pad is critical to avoiding thermal shutdown and ensuring reliable operation. Power dissipation of the device can be calculated using [Equation 9](#) and depends on input voltage and load conditions.

$$P_D = (V_{IN} - V_{OUT}) \times I_{OUT} \tag{9}$$

Power dissipation can be minimized and greater efficiency can be achieved by using the lowest possible input voltage necessary to achieve the required output voltage regulation.

On the VSON (DRC) package, the primary conduction path for heat is through the exposed pad to the printed circuit board (PCB). The pad can be connected to ground or left floating; however, the thermal pad must be attached to an appropriate amount of copper PCB area to ensure the device does not overheat. The maximum junction-to-ambient thermal resistance can be calculated using [Equation 10](#) and depends on the maximum ambient temperature, maximum device junction temperature, and power dissipation of the device.

$$R_{\theta JA} = \frac{(+125^{\circ}\text{C} - T_A)}{P_D} \quad (10)$$

The minimum amount of PCB copper area needed for appropriate heat sinking (which can be estimated using [Figure 8-4](#)) is determined by knowing the maximum $R_{\theta JA}$.

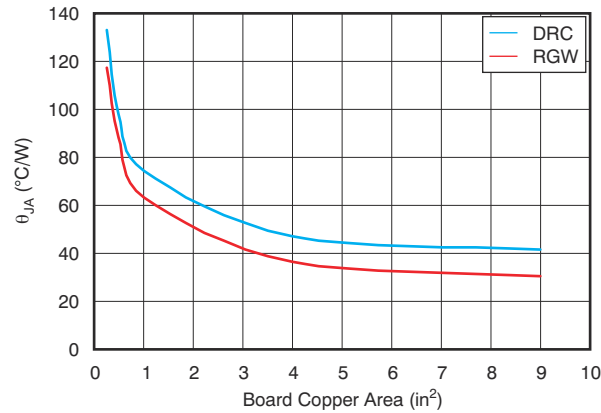

The $R_{\theta JA}$ value at board size of 9 in² (that is, 3 in × 3 in) is a JEDEC standard.

Figure 8-4. $R_{\theta JA}$ vs Board Size

[Figure 8-4](#) shows the variation of $R_{\theta JA}$ as a function of ground plane copper area in the board. This figure is intended only as a guideline to demonstrate the effects of heat spreading in the ground plane and is not intended to be used to estimate actual thermal performance in real application environments.

Note

When the device is mounted on an application PCB, use Ψ_{JT} and Ψ_{JB} , as explained in the [Estimating Junction Temperature](#) section.

8.4.2 Layout Example

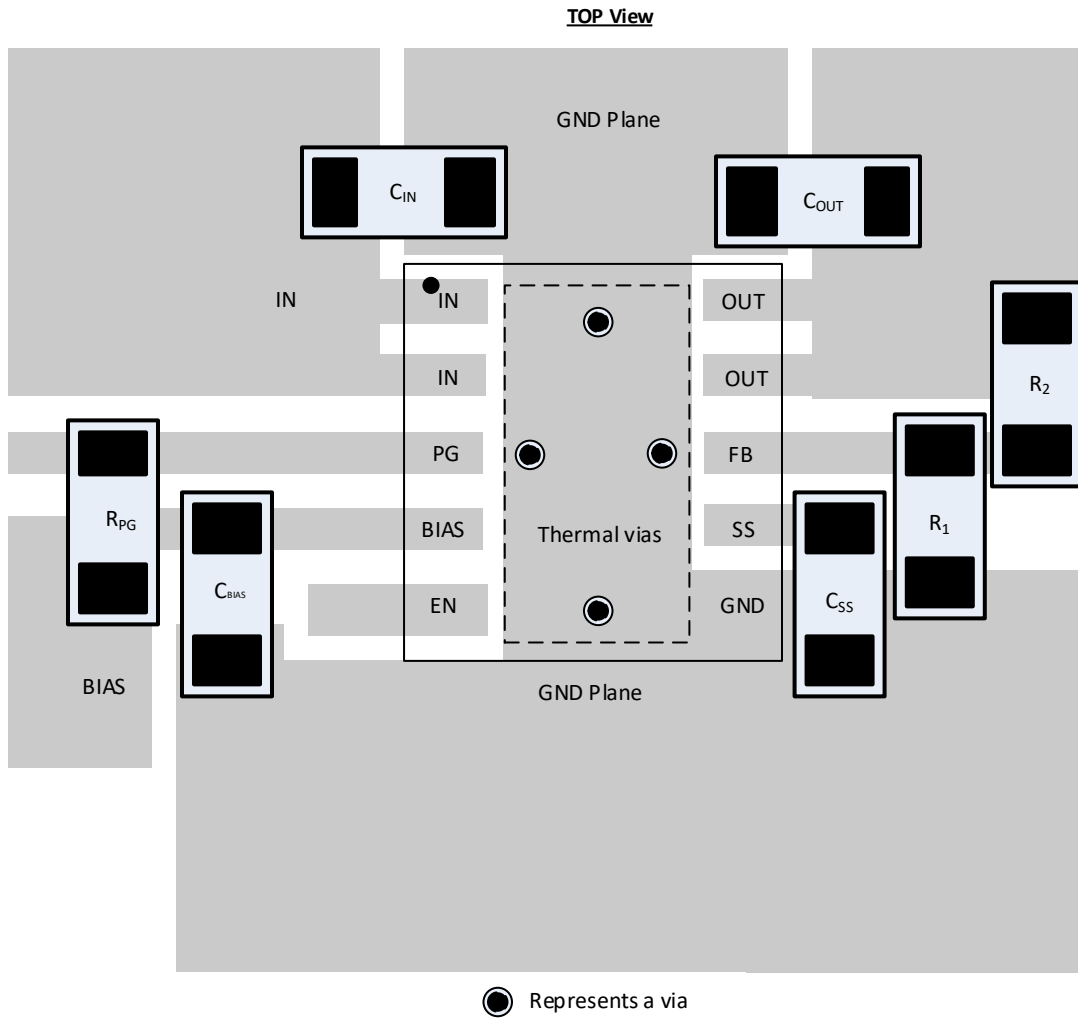

Figure 8-5. Example Layout

9 Device and Documentation Support

9.1 Receiving Notification of Documentation Updates

To receive notification of documentation updates, navigate to the device product folder on [ti.com](https://www.ti.com). Click on *Subscribe to updates* to register and receive a weekly digest of any product information that has changed. For change details, review the revision history included in any revised document.

9.2 Support Resources

TI E2E™ [support forums](#) are an engineer's go-to source for fast, verified answers and design help — straight from the experts. Search existing answers or ask your own question to get the quick design help you need.

Linked content is provided "AS IS" by the respective contributors. They do not constitute TI specifications and do not necessarily reflect TI's views; see TI's [Terms of Use](#).

9.3 Trademarks

TI E2E™ is a trademark of Texas Instruments.

All trademarks are the property of their respective owners.

9.4 Electrostatic Discharge Caution



This integrated circuit can be damaged by ESD. Texas Instruments recommends that all integrated circuits be handled with appropriate precautions. Failure to observe proper handling and installation procedures can cause damage.

ESD damage can range from subtle performance degradation to complete device failure. Precision integrated circuits may be more susceptible to damage because very small parametric changes could cause the device not to meet its published specifications.

9.5 Glossary

[TI Glossary](#) This glossary lists and explains terms, acronyms, and definitions.

10 Mechanical, Packaging, and Orderable Information

The following pages include mechanical, packaging, and orderable information. This information is the most current data available for the designated devices. This data is subject to change without notice and revision of this document. For browser-based versions of this data sheet, refer to the left-hand navigation.

PACKAGING INFORMATION

Orderable Device	Status (1)	Package Type	Package Drawing	Pins	Package Qty	Eco Plan (2)	Lead finish/ Ball material (6)	MSL Peak Temp (3)	Op Temp (°C)	Device Marking (4/5)	Samples
TPS74801AQWDRCRQ1	ACTIVE	VSON	DRC	10	3000	RoHS & Green	NIPDAU	Level-2-260C-1 YEAR	-40 to 150	74801A	Samples

(1) The marketing status values are defined as follows:

ACTIVE: Product device recommended for new designs.

LIFEBUY: TI has announced that the device will be discontinued, and a lifetime-buy period is in effect.

NRND: Not recommended for new designs. Device is in production to support existing customers, but TI does not recommend using this part in a new design.

PREVIEW: Device has been announced but is not in production. Samples may or may not be available.

OBSELETE: TI has discontinued the production of the device.

(2) **RoHS:** TI defines "RoHS" to mean semiconductor products that are compliant with the current EU RoHS requirements for all 10 RoHS substances, including the requirement that RoHS substance do not exceed 0.1% by weight in homogeneous materials. Where designed to be soldered at high temperatures, "RoHS" products are suitable for use in specified lead-free processes. TI may reference these types of products as "Pb-Free".

RoHS Exempt: TI defines "RoHS Exempt" to mean products that contain lead but are compliant with EU RoHS pursuant to a specific EU RoHS exemption.

Green: TI defines "Green" to mean the content of Chlorine (Cl) and Bromine (Br) based flame retardants meet JS709B low halogen requirements of <=1000ppm threshold. Antimony trioxide based flame retardants must also meet the <=1000ppm threshold requirement.

(3) MSL, Peak Temp. - The Moisture Sensitivity Level rating according to the JEDEC industry standard classifications, and peak solder temperature.

(4) There may be additional marking, which relates to the logo, the lot trace code information, or the environmental category on the device.

(5) Multiple Device Markings will be inside parentheses. Only one Device Marking contained in parentheses and separated by a "-" will appear on a device. If a line is indented then it is a continuation of the previous line and the two combined represent the entire Device Marking for that device.

(6) Lead finish/Ball material - Orderable Devices may have multiple material finish options. Finish options are separated by a vertical ruled line. Lead finish/Ball material values may wrap to two lines if the finish value exceeds the maximum column width.

Important Information and Disclaimer:The information provided on this page represents TI's knowledge and belief as of the date that it is provided. TI bases its knowledge and belief on information provided by third parties, and makes no representation or warranty as to the accuracy of such information. Efforts are underway to better integrate information from third parties. TI has taken and continues to take reasonable steps to provide representative and accurate information but may not have conducted destructive testing or chemical analysis on incoming materials and chemicals. TI and TI suppliers consider certain information to be proprietary, and thus CAS numbers and other limited information may not be available for release.

In no event shall TI's liability arising out of such information exceed the total purchase price of the TI part(s) at issue in this document sold by TI to Customer on an annual basis.

OTHER QUALIFIED VERSIONS OF TPS748A-Q1 :

- Catalog : [TPS748A](#)

NOTE: Qualified Version Definitions:

- Catalog - TI's standard catalog product

TAPE AND REEL INFORMATION

QUADRANT ASSIGNMENTS FOR PIN 1 ORIENTATION IN TAPE

*All dimensions are nominal

Device	Package Type	Package Drawing	Pins	SPQ	Reel Diameter (mm)	Reel Width W1 (mm)	A0 (mm)	B0 (mm)	K0 (mm)	P1 (mm)	W (mm)	Pin1 Quadrant
TPS74801AQWDRCRQ1	VSON	DRC	10	3000	330.0	12.4	3.3	3.3	1.1	8.0	12.0	Q2

TAPE AND REEL BOX DIMENSIONS

*All dimensions are nominal

Device	Package Type	Package Drawing	Pins	SPQ	Length (mm)	Width (mm)	Height (mm)
TPS74801AQWDRCRQ1	VSON	DRC	10	3000	360.0	360.0	36.0

GENERIC PACKAGE VIEW

DRC 10

VSON - 1 mm max height

3 x 3, 0.5 mm pitch

PLASTIC SMALL OUTLINE - NO LEAD

This image is a representation of the package family, actual package may vary.
Refer to the product data sheet for package details.

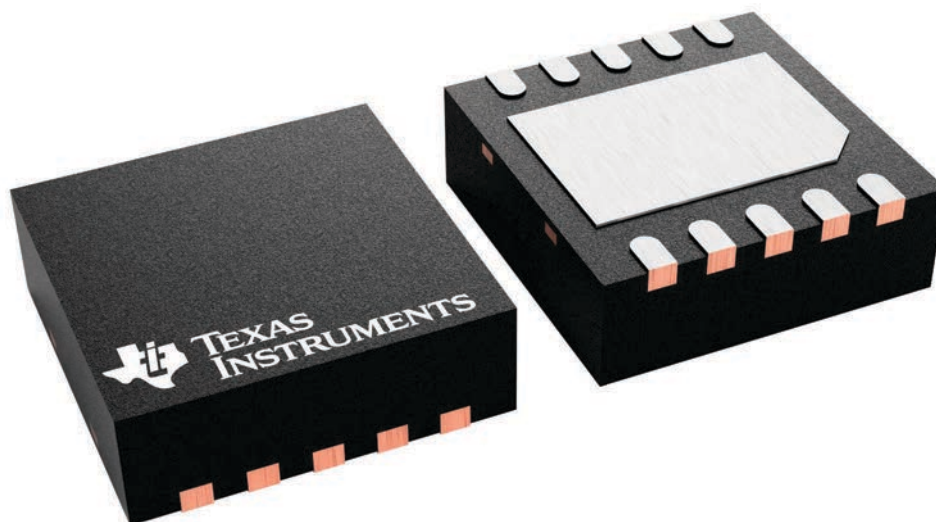

4226193/A

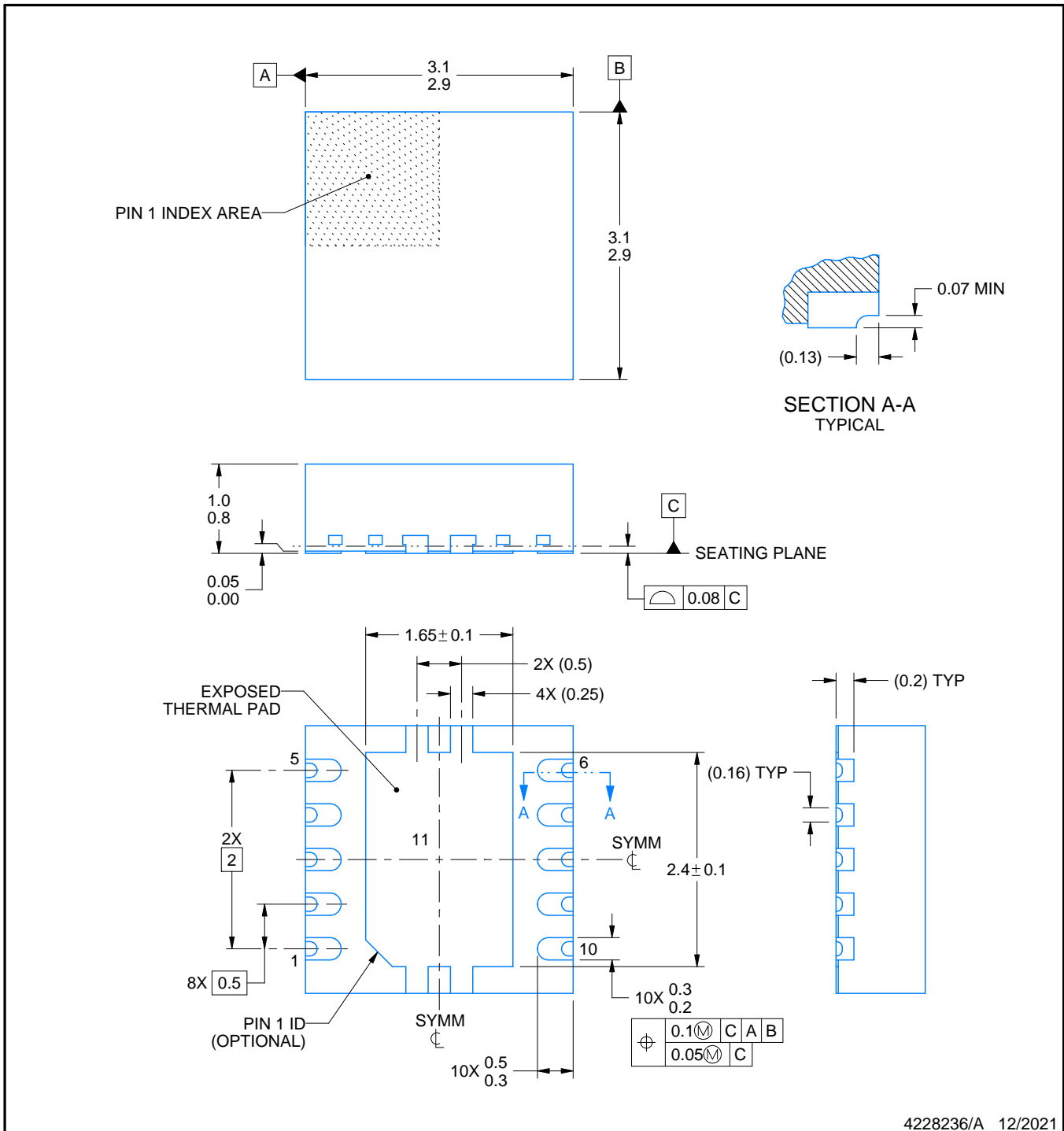
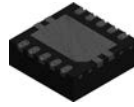

4228236/A 12/2021

NOTES:

1. All linear dimensions are in millimeters. Any dimensions in parenthesis are for reference only. Dimensioning and tolerancing per ASME Y14.5M.
2. This drawing is subject to change without notice.
3. The package thermal pad must be soldered to the printed circuit board for optimal thermal and mechanical performance.

EXAMPLE BOARD LAYOUT

DRC0010W

VSON - 1 mm max height

PLASTIC SMALL OUTLINE - NO LEAD

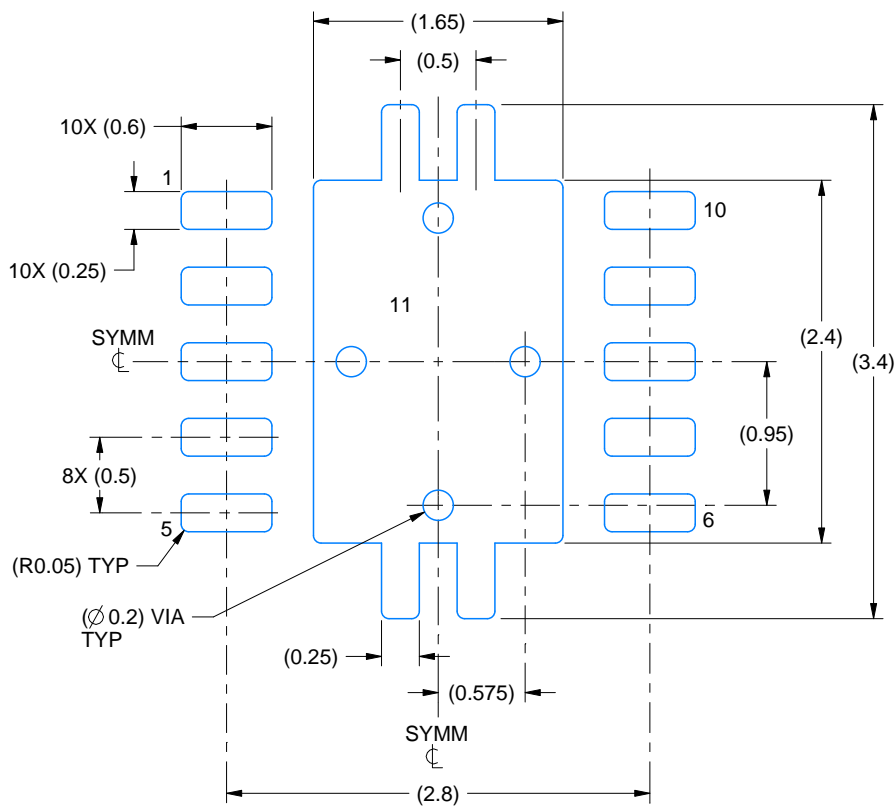

LAND PATTERN EXAMPLE
EXPOSED METAL SHOWN
SCALE:20X

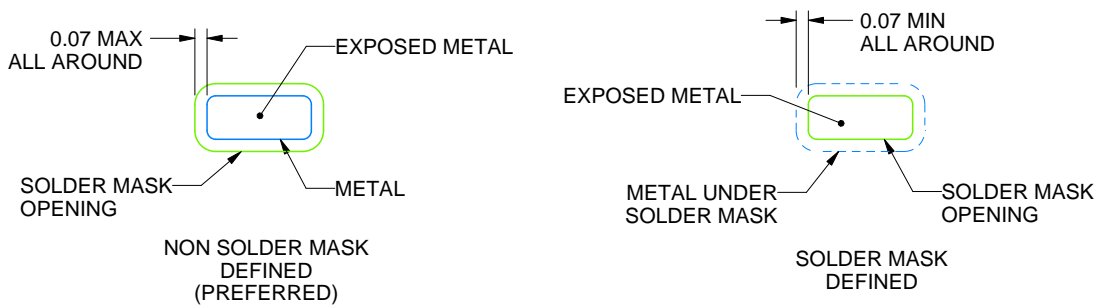

SOLDER MASK DETAILS

4228236/A 12/2021

NOTES: (continued)

4. This package is designed to be soldered to a thermal pad on the board. For more information, see Texas Instruments literature number SLUA271 (www.ti.com/lit/sluea271).
5. Vias are optional depending on application, refer to device data sheet. If any vias are implemented, refer to their locations shown on this view. It is recommended that vias under paste be filled, plugged or tented.

EXAMPLE STENCIL DESIGN

DRC0010W

VSON - 1 mm max height

PLASTIC SMALL OUTLINE - NO LEAD

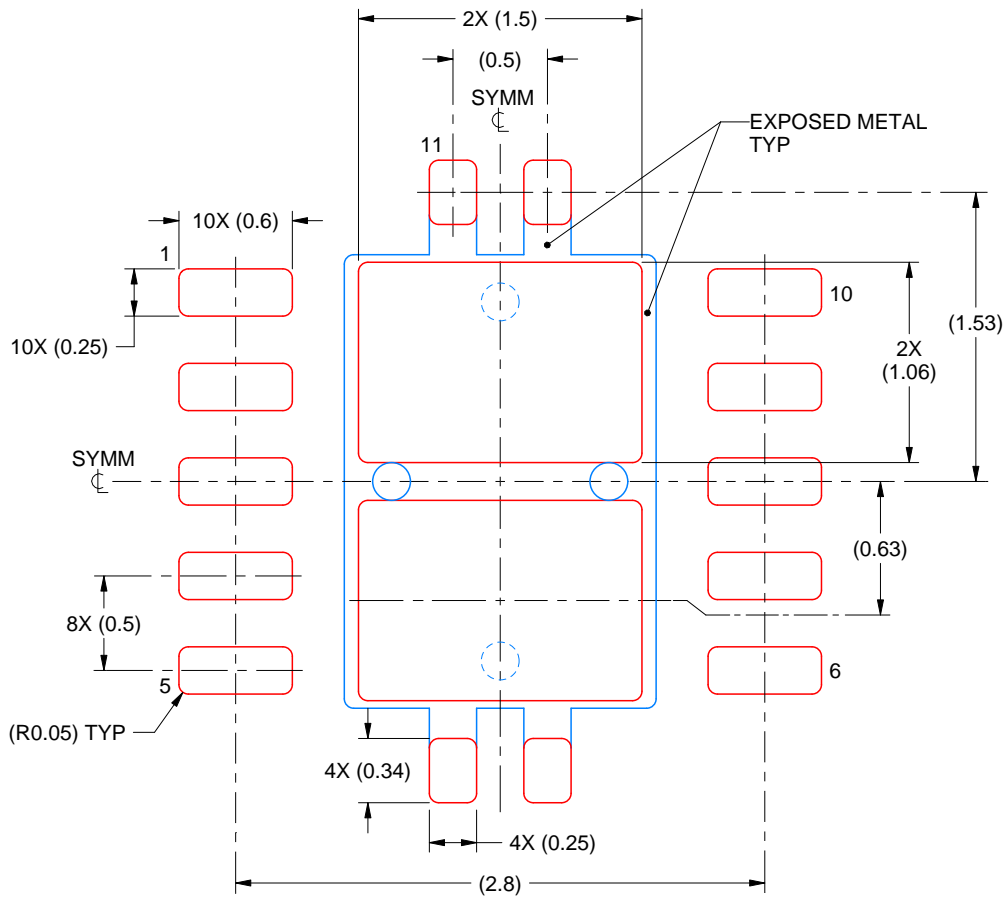

SOLDER PASTE EXAMPLE
BASED ON 0.125 mm THICK STENCIL

EXPOSED PAD 11:
80% PRINTED SOLDER COVERAGE BY AREA
SCALE:25X

4228236/A 12/2021

NOTES: (continued)

6. Laser cutting apertures with trapezoidal walls and rounded corners may offer better paste release. IPC-7525 may have alternate design recommendations.

IMPORTANT NOTICE AND DISCLAIMER

TI PROVIDES TECHNICAL AND RELIABILITY DATA (INCLUDING DATA SHEETS), DESIGN RESOURCES (INCLUDING REFERENCE DESIGNS), APPLICATION OR OTHER DESIGN ADVICE, WEB TOOLS, SAFETY INFORMATION, AND OTHER RESOURCES "AS IS" AND WITH ALL FAULTS, AND DISCLAIMS ALL WARRANTIES, EXPRESS AND IMPLIED, INCLUDING WITHOUT LIMITATION ANY IMPLIED WARRANTIES OF MERCHANTABILITY, FITNESS FOR A PARTICULAR PURPOSE OR NON-INFRINGEMENT OF THIRD PARTY INTELLECTUAL PROPERTY RIGHTS.

These resources are intended for skilled developers designing with TI products. You are solely responsible for (1) selecting the appropriate TI products for your application, (2) designing, validating and testing your application, and (3) ensuring your application meets applicable standards, and any other safety, security, regulatory or other requirements.

These resources are subject to change without notice. TI grants you permission to use these resources only for development of an application that uses the TI products described in the resource. Other reproduction and display of these resources is prohibited. No license is granted to any other TI intellectual property right or to any third party intellectual property right. TI disclaims responsibility for, and you will fully indemnify TI and its representatives against, any claims, damages, costs, losses, and liabilities arising out of your use of these resources.

TI's products are provided subject to [TI's Terms of Sale](#) or other applicable terms available either on [ti.com](https://www.ti.com) or provided in conjunction with such TI products. TI's provision of these resources does not expand or otherwise alter TI's applicable warranties or warranty disclaimers for TI products.

TI objects to and rejects any additional or different terms you may have proposed.

Mailing Address: Texas Instruments, Post Office Box 655303, Dallas, Texas 75265
Copyright © 2024, Texas Instruments Incorporated