

# TPS62830x, 2.25V to 5.5V Input, 1, 2, 3, 4A Step-Down Converter With 1% Output Accuracy in Small WQFN and SOT583 Packages

## 1 Features

- 2.25V to 5.5V input voltage range
- 0.5V to 4.5V adjustable output voltage
- 1% FB voltage accuracy ( $-40^{\circ}\text{C}$  to  $125^{\circ}\text{C}$   $T_J$ )
- Optimized EMI performance
- Facilitates CISPR 11/32 compliance
  - Integrated on-chip noise-filtering capacitors
  - Measurements according to CISPR available
- Excellent transient response
- 7 $\mu\text{A}$  operating quiescent current
- 2.0MHz switching frequency
- 35m $\Omega$  and 18m $\Omega$  internal power MOSFETs
- DCS-Control topology
- MODE pin for conduction mode selection
- Supports 1.2V GPIO
- 100% duty cycle for lowest dropout
- Active output discharge
- Power-good output
- Thermal shutdown protection
- Hiccup or latch-off OCP/OVP
- SIMPLIS model available
- Create a custom design using the TPS62830x with [WEBENCH® Power Designer](#)

## 2 Applications

- [Solid state drive](#)
- [Portable electronics](#)
- [Analog security](#) and [IP network](#) cameras
- [Industrial PC](#)
- [Factory automation and control](#)
- ASIC, SoC, and MCU supply
- Generic point of load

## 3 Description

The TPS62830x is an easy-to-use, synchronous, step-down, DC/DC converters family with low quiescent current. Based on the DCS-Control topology, TPS62830x provides a fast transient response with small output capacitance. The internal reference allows to regulate the output voltage down to 0.5V with a high feedback voltage accuracy of 1% over the junction temperature range of  $-40^{\circ}\text{C}$  to  $125^{\circ}\text{C}$ . The family is available in two packages and each package devices are pin-to-pin compatible.

The TPS62830x has a MODE pin to control the device mode of operation. Power save mode maintains high efficiency down to very light loads for extending the system battery run-time. Forced-PWM mode maintains a continuous conduction mode to

make sure the least ripple in the output voltage and a quasi-fixed switching frequency. The device features a Power-Good signal and a well-controlled internal soft-start circuit. TPS62830x is able to operate in 100% mode. For fault protection, TPS62830x incorporates a HICCUP short-circuit protection as well as a thermal shutdown. One device option has a latch-off protection for short circuit as well as overvoltage incidents. The family is available in two packages: an 8-pin 1.0mm  $\times$  2.0mm QFN package, offering the highest power density design, and an 8-pin 1.6mm  $\times$  2.1mm SOT583 package, offering an easy-to-assemble designs.

### Package Information

PART NUMBER	PACKAGE <sup>(1)</sup>	PACKAGE SIZE <sup>(2)</sup>
TPS62830x	RZE (WQFN, 8)	1mm $\times$ 2mm
	DRL (SOT583, 8)	2.1mm $\times$ 1.6mm

(1) For more information, see [Section 11](#).

(2) The package size (length  $\times$  width) is a nominal value and includes pins, where applicable

### Device Information

PART NUMBER <sup>(1)</sup>	OUTPUT CURRENT	OCP MODE	SOFT-START TIME
TPS62830xA	1A, 2A, 3A, 4A	Hiccup	300 $\mu\text{s}$
TPS62830xB	3A	Latch-off	300 $\mu\text{s}$
TPS62830xK	1A, 2A, 3A, 4A	Hiccup	880 $\mu\text{s}$

(1) See the [Device Options](#) table.

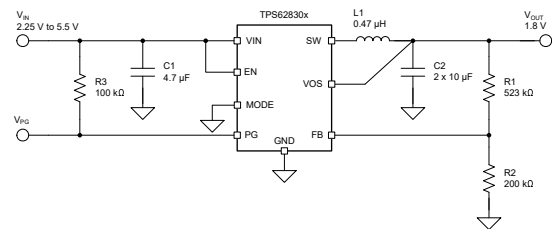

Typical Application Schematic

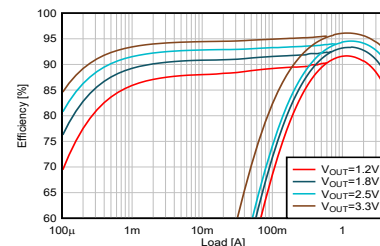

Efficiency at  $V_{IN} = 5\text{V}$



## Table of Contents

<b>1 Features</b> .....	1	7.4 Device Functional Modes.....	12
<b>2 Applications</b> .....	1	<b>8 Application and Implementation</b> .....	14
<b>3 Description</b> .....	1	8.1 Application Information.....	14
<b>4 Device Options</b> .....	3	8.2 Typical Application.....	14
<b>5 Pin Configuration and Functions</b> .....	4	8.3 Power Supply Recommendations.....	26
<b>6 Specifications</b> .....	5	8.4 Layout.....	26
6.1 Absolute Maximum Ratings.....	5	<b>9 Device and Documentation Support</b> .....	28
6.2 ESD Ratings.....	5	9.1 Device Support.....	28
6.3 Recommended Operating Conditions.....	5	9.2 Documentation Support.....	28
6.4 Thermal Information Discrete.....	5	9.3 Support Resources.....	28
6.5 Electrical Characteristics.....	6	9.4 Trademarks.....	28
6.6 Typical Characteristics.....	7	9.5 Electrostatic Discharge Caution.....	28
<b>7 Detailed Description</b> .....	8	9.6 Glossary.....	28
7.1 Overview.....	8	<b>10 Revision History</b> .....	29
7.2 Functional Block Diagram.....	8	<b>11 Mechanical, Packaging, and Orderable Information</b> .....	29
7.3 Feature Description.....	8		

## 4 Device Options

PART NUMBER	OUTPUT CURRENT	SOFT START, $t_{ss}$	OCP MODE	PACKAGE	OUTPUT VOLTAGE
TPS628301ARZER	1A	300 $\mu$ s	Hiccup	WQFN-HR	Adjustable <sup>(2)</sup>
TPS628302ARZER	2A				
TPS628303ARZER	3A				
TPS628304ARZER	4A				
TPS628301KRZER	1A	880 $\mu$ s			
TPS628302KRZER	2A				
TPS628303KRZER	3A				
TPS628304KRZER	4A				
TPS628301ADRLR	1A	300 $\mu$ s	OCP/OVP Latch-off <sup>(1)</sup>	SOT583	
TPS628302ADRLR	2A				
TPS628303ADRLR	3A				
TPS628304ADRLR	4A				
TPS628303BDRLR	3A				

(1) For other output current versions with OCP/OVP Latch-off, please contact Marketing for availability.

(2) For fixed output voltage versions, please contact Marketing for availability.

## 5 Pin Configuration and Functions

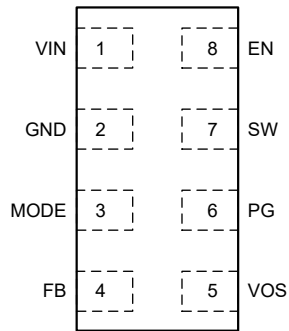

Figure 5-1. RZE Package 8-Pin WQFN Top View

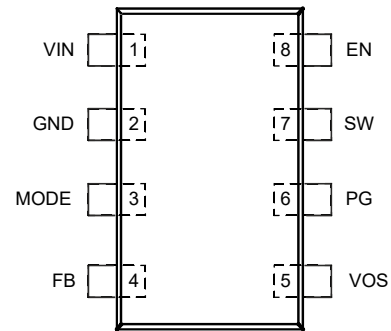

Figure 5-2. DRL Package 8-Pin SOT Top View

Table 5-1. Pin Functions

PIN		TYPE <sup>(1)</sup>	DESCRIPTION
NAME	NO.		
VIN	1	PWR	Input voltage pin. Connect the input capacitor as close as possible between $V_{IN}$ and GND.
GND	2		Ground pin.
MODE	3	I	The device runs in PSM/PWM mode when this pin is pulled low and in forced-PWM mode when pulled high. This event can also be done when the device is in-operation. Do not leave this pin floating.
FB	4	I	Feedback pin. Connect the resistive output voltage divider to this pin.
VOS	5	I	Output voltage sense pin. This pin must be connected directly after the inductor.
PG	6	O	Power good open-drain output pin. The pullup resistor can be connected to voltages up to 5.5 V. If unused, leave this pin floating.
SW	7	PWR	Switch pin of the power stage
EN	8	I	Device enable pin. To enable the device, this pin must be pulled high. Pulling this pin low disables the device. Do not leave this pin unconnected.

(1) I = input, O = output, PWR = power

## 6 Specifications

### 6.1 Absolute Maximum Ratings

Over operating junction temperature range (unless otherwise noted) <sup>(1)</sup>

		MIN	MAX	UNIT
Voltage <sup>(2)</sup>	V <sub>IN</sub> , EN, MODE, FB, PG	-0.3	6	V
Voltage <sup>(2)</sup>	SW (DC)	-0.3	V <sub>IN</sub> + 0.3	V
Voltage <sup>(2)</sup>	SW (AC, < 10 ns) <sup>(3)</sup>	-2.5	10	V
T <sub>J</sub>	Operating junction temperature	-40	150	°C
T <sub>stg</sub>	Storage temperature	-65	150	°C

- (1) Operation outside the Absolute Maximum Ratings may cause permanent device damage. Absolute Maximum Ratings do not imply functional operation of the device at these or any other conditions beyond those listed under Recommended Operating Conditions. If used outside the Recommended Operating Conditions but within the Absolute Maximum Ratings, the device may not be fully functional, and this may affect device reliability, functionality, performance, and shorten the device lifetime.
- (2) All voltage values are with respect to the network ground terminal.
- (3) While switching

### 6.2 ESD Ratings

			VALUE	UNIT
V <sub>(ESD)</sub>	Electrostatic discharge	Human-body model (HBM), per ANSI/ESDA/JEDEC JS-001 <sup>(1)</sup>	± 2000	V
		Charged-device model (CDM), per ANSI/ESDA/JEDEC JS-002 <sup>(2)</sup>	± 500	

- (1) JEDEC document JEP155 states that 500-V HBM allows safe manufacturing with a standard ESD control process.
- (2) JEDEC document JEP157 states that 250-V CDM allows safe manufacturing with a standard ESD control process.

### 6.3 Recommended Operating Conditions

Over operating junction temperature range (unless otherwise noted)

		MIN	NOM	MAX	UNIT
V <sub>IN</sub>	Input voltage range	2.25		5.5	V
V <sub>OUT</sub>	Output voltage range	0.5		4.5	V
C <sub>IN</sub>	Effective input capacitance <sup>(1)</sup>	3			µF
L	Nominal output inductor	0.24	0.47	1.0	µH
C <sub>OUT</sub>	Effective output capacitance <sup>(1)</sup>	12		200	µF
I <sub>OUT</sub>	Output current range; TPS628301			1	A
I <sub>OUT</sub>	Output current range; TPS628302			2	A
I <sub>OUT</sub>	Output current range; TPS628303			3	A
I <sub>OUT</sub>	Output current range; TPS628304 <sup>(2)</sup>			4	A
I <sub>PG</sub>	Power-good input current capability			1	mA
T <sub>J</sub>	Operating junction temperature	-40		125	°C

- (1) The values given for all the capacitors in the table are effective capacitance, which includes the DC bias effect. Due to the DC bias effect of ceramic capacitors, the effective capacitance is lower than the nominal value when a voltage is applied. Please check the manufacturer's DC bias curves for the effective capacitance vs DC voltage applied.
- (2) Lifetime is reduced when operating continuously at I<sub>OUT</sub> = 4 A and the junction temperature > 105°C.

### 6.4 Thermal Information Discrete

THERMAL METRIC <sup>(1)</sup>		TPS62830xRZE		TPS62830xDRL		UNIT
		8 pin-WQFN		8 pin-SOT583		
		JEDEC	EVM	JEDEC	EVM	
R <sub>θJA</sub>	Junction-to-ambient thermal resistance	105.7	77.6	110.9	80	°C/W
R <sub>θJC(top)</sub>	Junction-to-case (top) thermal resistance	90.9	n/a <sup>(2)</sup>	41.4	n/a <sup>(2)</sup>	°C/W
R <sub>θJB</sub>	Junction-to-board thermal resistance	30.7	n/a <sup>(2)</sup>	22.2	n/a <sup>(2)</sup>	°C/W
ψ <sub>JT</sub>	Junction-to-top characterization parameter	2.7	2.8	0.8	1.3	°C/W

## 6.4 Thermal Information Discrete (continued)

THERMAL METRIC <sup>(1)</sup>		TPS62830xRZE		TPS62830xDRL		UNIT
		8 pin-WQFN		8 pin-SOT583		
		JEDEC	EVM	JEDEC	EVM	
$\Psi_{JB}$	Junction-to-board characterization parameter	30.7	44.7	22.1	28.2	°C/W

- (1) For more information about traditional and new thermal metrics, see the [Semiconductor and IC Package Thermal Metrics](#) report.  
 (2) Not applicable to an EVM.

## 6.5 Electrical Characteristics

$T_J = -40^{\circ}\text{C}$  to  $+125^{\circ}\text{C}$ ,  $V_{IN} = 2.25\text{ V}$  to  $5.5\text{ V}$ . Typical values are at  $T_J = 25^{\circ}\text{C}$  and  $V_{IN} = 5\text{ V}$  (unless otherwise noted)

PARAMETER		TEST CONDITIONS	MIN	TYP	MAX	UNIT
<b>SUPPLY</b>						
$I_Q$	Operating quiescent current	$EN = V_{IN}$ , $I_{OUT} = 0\text{ mA}$ , $V_{OUT} = 1.8\text{ V}$ , $MODE = \text{GND}$ , device not switching		7	17	$\mu\text{A}$
$I_{SD}$	$V_{IN}$ shutdown supply current	$EN = \text{low}$ , $T_J = -40^{\circ}\text{C}$ to $85^{\circ}\text{C}$		100	700	nA
$V_{UVLO(+)}$	Rising UVLO threshold voltage ( $V_{IN}$ )		2.05	2.15	2.25	V
$V_{UVLO(hys)}$	UVLO hysteresis ( $V_{IN}$ )		90	120		mV
<b>THERMAL SHUTDOWN</b>						
$T_{J(SD)}$	Thermal shutdown threshold	$T_J$ rising		150		°C
$T_{J(HYS)}$	Thermal shutdown hysteresis			20		°C
<b>LOGIC PINS</b>						
$V_{EN(+)}$	High-level input voltage (EN)		0.8			V
$V_{EN(-)}$	Low-level input voltage (EN)				0.35	V
$V_{MODE(+)}$	High-level input voltage (MODE)		0.8			V
$V_{MODE(-)}$	Low-level input voltage (MODE)				0.35	V
$I_{EN(LKG)}$	EN Input leakage current	$V_{EN} = \text{HIGH}$		10	100	nA
$I_{MODE(LKG)}$	MODE Input leakage current	$V_{MODE} = \text{HIGH}$		10	100	nA
<b>STARTUP</b>						
$t_{SS}$	Internal fixed soft-start time	From $V_{OUT} = 0$ to $V_{OUT} = 95\%$	180	300	440	$\mu\text{s}$
$t_{SS}$	Internal fixed soft-start time	From $V_{OUT} = 0$ to $V_{OUT} = 95\%$ ; only TPS62830xK versions	530	880	1300	$\mu\text{s}$
$t_{d(EN)}$	Enable delay time	From EN HIGH to device starts switching		120	220	$\mu\text{s}$
<b>REFERENCE VOLTAGE</b>						
$V_{FB}$	Feedback voltage accuracy	PWM mode	495	500	505	mV
$V_{FB}$	Feedback voltage accuracy	PWM mode	-1		+1	%
$V_{FB}$	Feedback voltage accuracy	PFM mode, $C_{OUT,eff} \geq 15\text{ }\mu\text{F}$ , $L = 0.47\text{ }\mu\text{H}$	-1		+2	%
$I_{FB(LKG)}$	FB input leakage current, adjustable version	$V_{FB} = 0.5\text{ V}$		10	70	nA
$I_{VOS(LKG)}$	VOS input leakage current	$V_{EN} = \text{low}$		100	500	nA
<b>POWER GOOD</b>						
$V_{PG,UV(+)}$	Rising power-good threshold voltage (output undervoltage)	Power Good low, $V_{FB}$ rising	94	96	98	%
$V_{PG,UV(-)}$	Falling power-good threshold voltage (output undervoltage)	Power Good high, $V_{FB}$ falling	90	92	94	%
$V_{PG,OV(+)}$	Rising power-good threshold voltage (output overvoltage)	Power Good high, $V_{FB}$ rising	108	110	112	%
$V_{PG,OV(-)}$	Falling power-good threshold voltage (output overvoltage)	Power Good low, $V_{FB}$ falling	102.5	105	107	%
$t_{d(PG)}$	Power good delay at start-up	Low-to-high transition on the PG pin at start up		128		$\mu\text{s}$
$t_{d(PG)}$	Power good deglitch delay during operation	High-to-low or low-to-high transition on the PG pin	30	45	60	$\mu\text{s}$
$I_{PG(LKG)}$	PG pin Leakage current when open drain output is high	$V_{PG} = 5.0\text{ V}$		10	100	nA
$V_{PG,OL}$	PG pin low-level output voltage	$I_{PG} = 1\text{ mA}$			0.4	V

### 6.5 Electrical Characteristics (continued)

$T_J = -40^{\circ}\text{C}$  to  $+125^{\circ}\text{C}$ ,  $V_{IN} = 2.25\text{ V}$  to  $5.5\text{ V}$ . Typical values are at  $T_J = 25^{\circ}\text{C}$  and  $V_{IN} = 5\text{ V}$  (unless otherwise noted)

PARAMETER	TEST CONDITIONS	MIN	TYP	MAX	UNIT	
<b>POWER STAGE</b>						
$R_{DS(on)}$	High-side MOSFET on-resistance	$V_{IN} \geq 5\text{ V}$	35	57	m $\Omega$	
$R_{DS(on)}$	Low-side MOSFET on-resistance	$V_{IN} \geq 5\text{ V}$	18	29	m $\Omega$	
$f_{sw}$	Switching frequency, PWM mode	$I_{OUT} = 1\text{ A}$ , $V_{OUT} = 1.8\text{ V}$	2.0		MHz	
<b>OVERCURRENT PROTECTION</b>						
$I_{HS(OC)}$	High-side peak current limit	TPS628301	1.8	2.1	2.6	A
$I_{HS(OC)}$	High-side peak current limit	TPS628302	2.7	3.3	3.9	A
$I_{HS(OC)}$	High-side peak current limit	TPS628303	4.0	4.6	5.4	A
$I_{HS(OC)}$	High-side peak current limit	TPS628304	5.0	5.9	7.0	A
$I_{LS(NOC)}$	Low-side negative current limit	Sinking current limit on LS FET		-1.8		A
<b>OUTPUT DISCHARGE</b>						
$I_{DIS}$	Output discharge current on SW pin	$V_{IN} > 2\text{ V}$ , $V_{SW} = 0.4\text{ V}$ , $EN = \text{LOW}$	75	400		mA
<b>OUTPUT OVP</b>						
$V_{OVP}$	Overvoltage-protection (OVP) threshold voltage	$V_{FB}$ rising; devices with OVP feature only	108	110	112	%
$t_{d(OVP)}$	OVP delay	Devices with OVP feature only		35		$\mu\text{s}$

### 6.6 Typical Characteristics

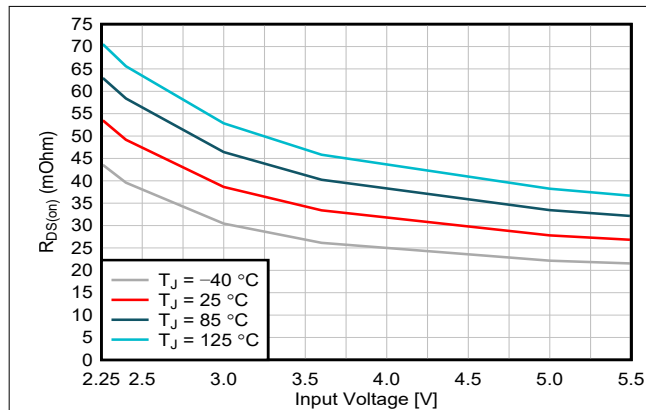

**Figure 6-1. High-Side FET On-Resistance**

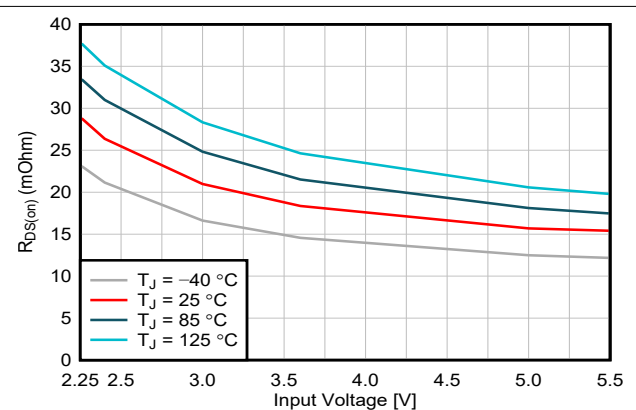

**Figure 6-2. Low-Side FET On-Resistance**

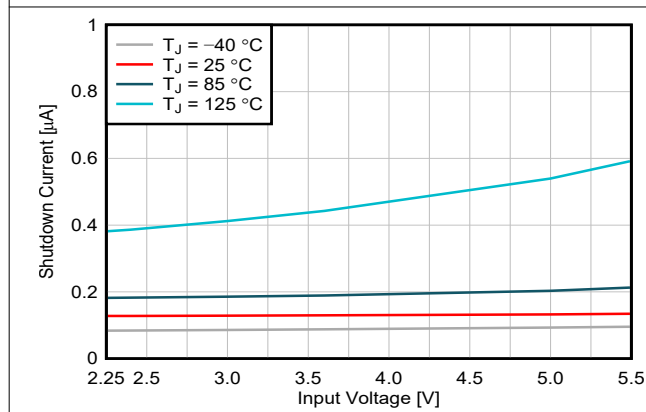

**Figure 6-3. Shutdown Current**

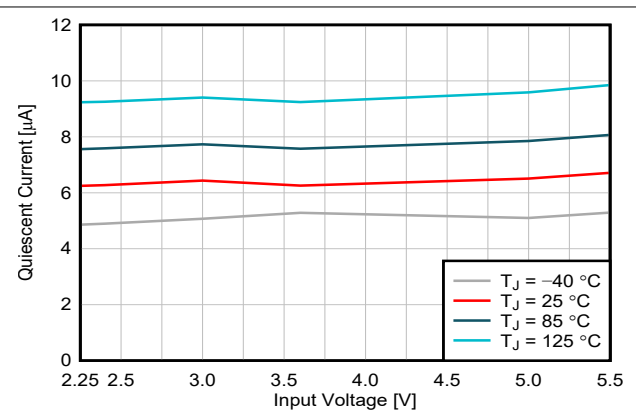

**Figure 6-4. Quiescent Current**

## 7 Detailed Description

### 7.1 Overview

The TPS62830x is a family of low-voltage step-down converters available in 1-, 2-, 3- and 4-A versions. These devices use a DCS-Control scheme which transitions seamlessly from pulse-width modulation (PWM) at medium and high output currents to pulsed-frequency modulation (PFM) at low output currents. During PWM operation, the devices switch at 2 MHz; during PFM operation, the switching frequency varies with the load current and reduces as the load current decreases. For applications that require the lowest possible output voltage ripple or a constant switching frequency, a high logic level on the MODE pin forces the devices to use PWM under all load conditions (at the expense of lower efficiency at low output currents). An external resistor-divider sets the output voltage anywhere from 0.5 V to 4.5 V and the nominal switching frequency is 2 MHz with a controlled variation over the input voltage range.

Device variants are available that support both hiccup and latch-off protection behavior.

The TPS62830x devices offer two significant advantages compared to previous devices in this series: Transient performance has improved significantly by usage of a fast comparator in both PFM and PWM modes, and EMI is reduced by an on-chip decoupling capacitor and an optimized gate driver.

### 7.2 Functional Block Diagram

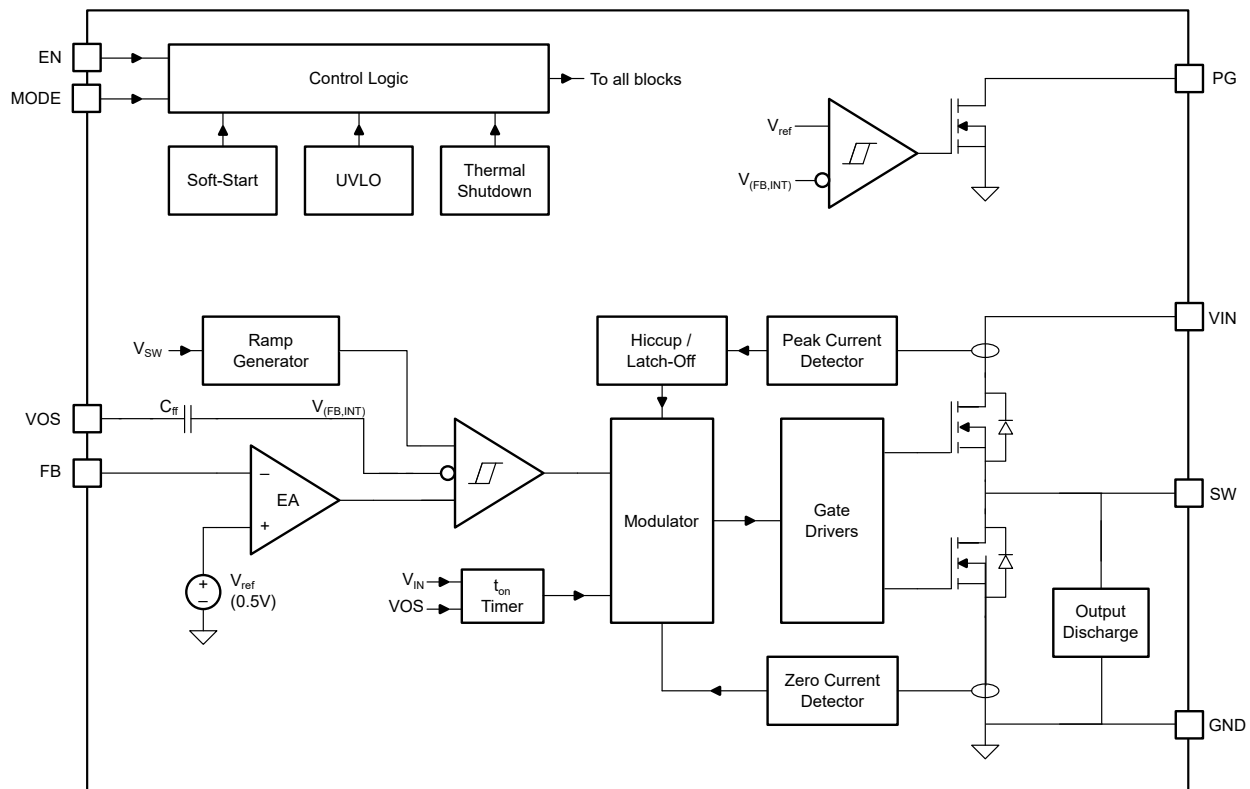

### 7.3 Feature Description

#### 7.3.1 Pulse Width Modulation (PWM) Operation

If the MODE pin is LOW and at load currents larger than half the inductor ripple current, the device operates in pulse width modulation in continuous conduction mode (CCM) as shown in Figure 7-1. The PWM operation is based on an adaptive constant on-time control with stabilized switching frequency. To achieve a stable switching frequency in a steady state condition, the on-time is calculated as:

$$T_{ON} = \frac{V_{OUT}}{V_{IN}} \times 500ns \quad (1)$$



If the MODE pin is HIGH, the converter maintains a forced-PWM operation for all load currents.

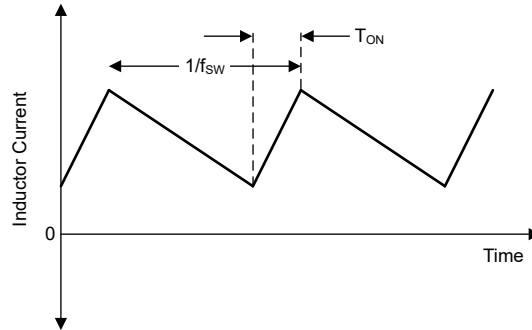
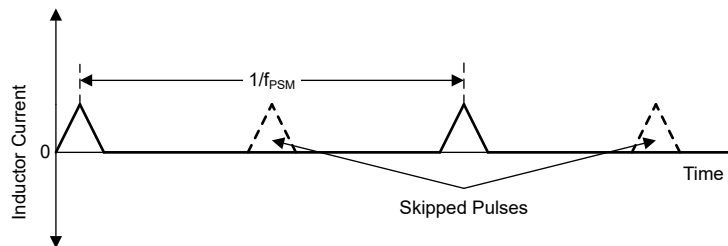

**Figure 7-1. Continuous Conduction Mode (PWM-CCM) Current Waveform**

### 7.3.2 Power Save Mode (PSM) Operation

To maintain high efficiency at light loads, the device enters power save mode (PSM) at the boundary to discontinuous conduction mode (DCM). This event happens when the output current becomes smaller than half of the ripple current of the inductor. The device operates with a fixed on-time, and the switching frequency decreases proportional to the load current as shown in [Figure 7-2](#). Calculate as:

$$f_{PSM} = \frac{2 \times I_{OUT}}{T_{ON}^2 \times \frac{V_{IN}}{V_{OUT}} \left[ \frac{V_{IN} - V_{OUT}}{L} \right]} \quad (2)$$

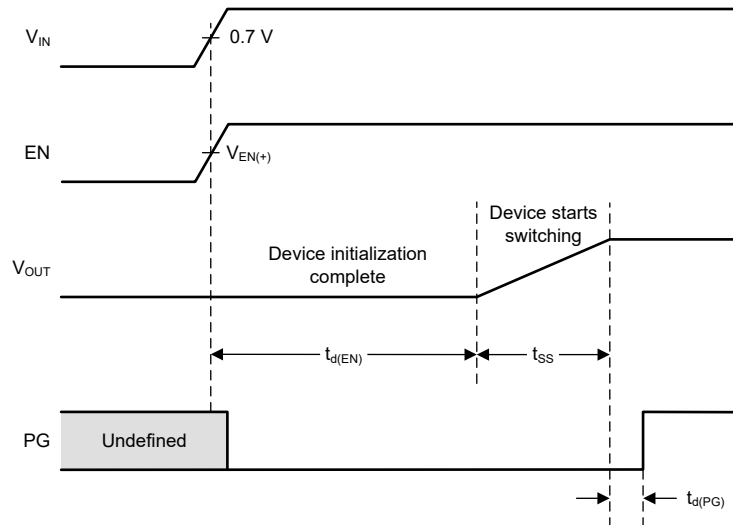

**Figure 7-2. Discontinuous Conduction Mode (PSM-DCM) Current Waveform**

In PSM, the output voltage rises slightly above the nominal target, which can be minimized using larger output capacitance. At duty cycles larger than 90%, the device does not enter PSM and maintains output regulation in PWM mode.

### 7.3.3 Start-Up and Soft Start

When the EN voltage goes High, the device starts loading the default values into the device registers. This action typically is done within 120 μs. After that, the internal soft-start circuitry controls the output voltage during start-up. This control avoids excessive inrush current and makes sure of a controlled output voltage ramp. This control also prevents unwanted voltage drops from high-impedance power sources or batteries. Finally, the PG signal has a delay up to 180 μs at start-up. [Figure 7-3](#) shows a start-up sequence, where the EN pin is pulled up to VIN.



**Figure 7-3. Start-Up Timing When EN is Pulled Up to VIN**

Figure 7-4 shows a start-up sequence, where an external signal is connected to the EN pin.

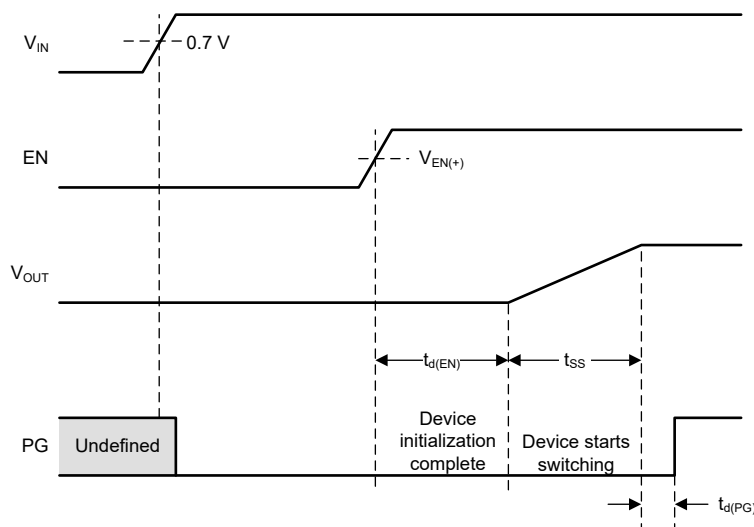

**Figure 7-4. Start-Up Timing When an External Signal is Connected to the EN Pin**

The TPS62830x can start into a prebiased output if enabled for the first time. For a new prebiased operation, a power cycle is needed to disable the active output discharge. Figure 7-5 shows a start-up into a prebiased output voltage.

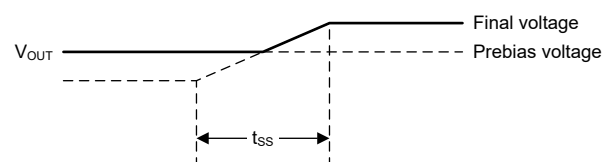

**Figure 7-5. Start-Up into a Prebiased Output**

### 7.3.4 Switch Cycle-by-Cycle Current Limit

All the devices in the family have a cycle-by-cycle current limit function. When the device detects that the current in the high-side FET exceeds the high-side current limit, either due to a heavy load or a short-circuit condition,

the device immediately turns off the high-side FET and turns on the low-side FET. The high-side FET turns on again at the start of the next switching cycle. Note that because of the propagation delay in the current limit comparator (typically 60 ns), the current flowing in the high-side FET when the device detects a current limit condition can be slightly higher than the current limit specified in the device Electrical Characteristics.

Devices with an 'A' and 'K' suffix in their part number respond to repeated current limit events with hiccup behavior (see *Device Options*).

Devices with a 'B' suffix in their part number respond to repeated current limit events with latch-up behavior (see *Device Options*).

### 7.3.5 Short-Circuit Protection

In devices with hiccup protection, when a current limit event occurs for 32 consecutive switching cycles (about 16  $\mu$ s), the device turns off the high-side FET for about 9.6 ms, during which time the inductor current decays through the low-side FET body diode. After 9.6 ms has expired, the device automatically starts switching again, beginning with a soft-start condition. The device alternates between bursts of switching cycles and 9.6-ms pauses for as long as the overload condition on the output exists.

In devices with latch-off protection, When a current limit event occurs for 32 consecutive switching cycles (about 16  $\mu$ s), the device stops switching and latches off the high-side and low-side FETs. To recover normal operation after a latched short-circuit event, you must cycle  $V_{IN}$  or EN.

In devices with latch-off protection, there is also an OVP protection circuit that uses the PG window comparator. An OVP event is detected when the FB voltage is approximately  $110\% \times (0.5V)$  for a period longer than the deglitch time of 35  $\mu$ s. In this case, the converter de-asserts the PG signal and performs the overvoltage protection function. The converter latches off both high-side and low-side FET and remains in this state. To recover normal operation after a latched short-circuit event, you must cycle  $V_{IN}$  or EN.

### 7.3.6 Undervoltage Lockout

The undervoltage lockout (UVLO) function prevents misoperation of the device if the input voltage drops below the UVLO threshold.

### 7.3.7 Thermal Shutdown

The junction temperature ( $T_J$ ) of the device is monitored by an internal temperature sensor. If  $T_J$  exceeds 150°C (typical), the device goes in thermal shutdown with a hysteresis of typically 20°C. After  $T_J$  has decreased enough, the device resumes normal operation.

### 7.3.8 Optimized EMI Performance

TPS62830x devices incorporate advanced techniques to minimize Electromagnetic Interference (EMI) and makes complying with stringent EMI standards simple. By integrating capacitors directly onto the silicon, parasitic elements are reduced and loop area is minimized, effectively reducing high-frequency noise emissions primarily above 450 MHz. The on-chip capacitors ensure low-inductance paths for high-frequency AC switching current and damping voltage ringing.

Additionally to the on-chip capacitors, the gate driver has been improved with advanced slew rate control mechanisms and by smoothing the supply voltage. The switch node voltage is controlled in a way to reduce sharp edges and minimize voltage overshoot, consequently diminishing EMI.

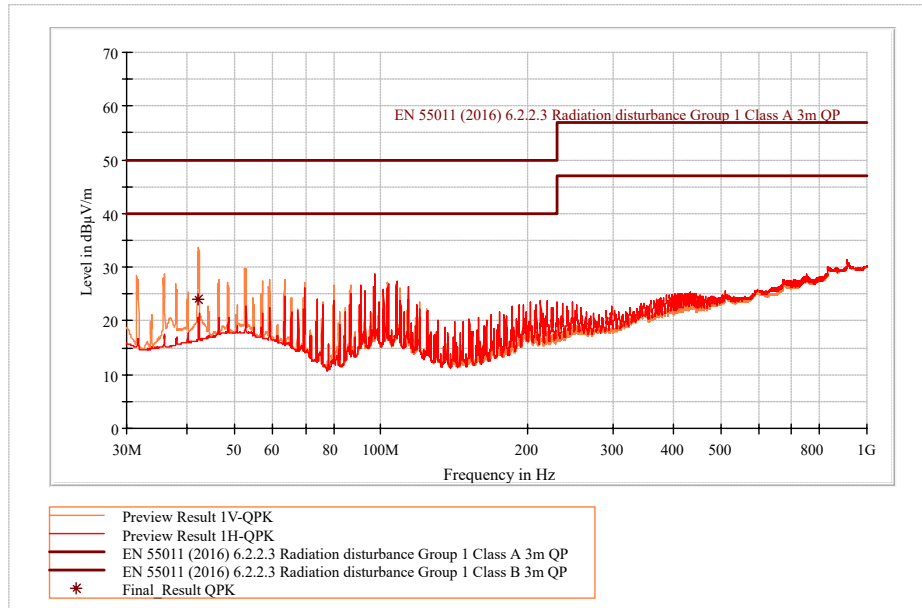

The above plot is measured on the EVM with the TPS628304ARZER and standard BOM. There is no notable difference on EMI performance between available packages.

$$I_{OUT} = 4 \text{ A}$$

$$V_{IN} = 5.5 \text{ V}$$

$$V_{OUT} = 1.8 \text{ V}$$

**Figure 7-6. Radiated EMI Performance (CISPR11 Radiated Emission Test with Class A and Class B Limits)**

## 7.4 Device Functional Modes

### 7.4.1 Enable, Disable, and Output Discharge

The device starts operation when Enable (EN) is set High. The input threshold levels are typically 0.8 V for rising and 0.35 V for falling signals. Do not leave EN floating. Shutdown is forced if EN is pulled Low with a shutdown current of typically 100 nA. During shutdown, the internal power MOSFETs as well as the entire control circuitry are turned off and the output voltage is actively discharged through the SW pin by a current sink. Therefore  $V_{IN}$  must remain present for the discharge to function.

### 7.4.2 Minimum Duty Cycle and 100% Mode Operation

There is no limitation for small duty cycles because, even at very low duty cycles, the switching frequency is reduced as needed to always make sure of a proper regulation.

If the output voltage ( $V_{OUT}$ ) comes close to the input voltage ( $V_{IN}$ ), the device enters 100% mode. While the high-side switch is constantly turned on, the low-side switch is switched off. This action is particularly useful in battery-powered applications to achieve longest operation time by taking full advantage of the whole battery voltage range. The difference between  $V_{IN}$  and  $V_{OUT}$  is determined by the voltage drop across the high-side FET and the DC resistance of the inductor. The minimum  $V_{IN}$  that is needed to maintain a specific  $V_{OUT}$  value is estimated as:

$$V_{IN,min} = V_{OUT} + I_{OUT,MAX} \times (R_{DS(on)} + R_L) \quad (3)$$

where

- $V_{IN,min}$  = Minimum input voltage to maintain an output voltage
- $I_{OUT,MAX}$  = Maximum output current
- $R_{DS(on)}$  = High-side FET ON-resistance
- $R_L$  = Inductor ohmic resistance (DCR)

### 7.4.3 Power Good

The TPS62830x has a built-in power-good (PG) function. The PG pin goes high impedance when the output voltage has reached the nominal value. Otherwise, including when disabled, in UVLO or in thermal shutdown, PG is Low (see Table 7-1). The PG function is formed with a window comparator, which has an upper and lower voltage threshold. The PG pin is an open-drain output and is specified to sink up to 1 mA. The power-good output requires a pullup resistor connecting to any voltage rail less than 5.5 V.

**Table 7-1. PG Pin Logic**

DEVICE CONDITIONS		LOGIC STATUS	
		HIGH Z	LOW
Enable	EN = High, $V_{FB} \geq 0.48$ V	√	
	EN = High, $V_{FB} \leq 0.56$ V		√
	EN = High, $V_{FB} \leq 0.525$ V	√	
	EN = High, $V_{FB} \geq 0.55$ V		√
Shutdown	EN = Low		√
Thermal shutdown	$T_J > T_{JSD}$		√
UVLO	$0.7$ V < $V_{IN}$ < $V_{UVLO}$		√
Power supply removal	$V_{IN} < 0.7$ V	√	

The PG signal can be used for sequencing of multiple rails by connecting the PG signal to the EN pin of other converters. Leave the PG pin unconnected when not used. The PG rising edge and falling edge has a 40 μs blanking time, as shown in Figure 7-7. At start-up, the delay of PG signal is typically 125 μs after soft start is finished.

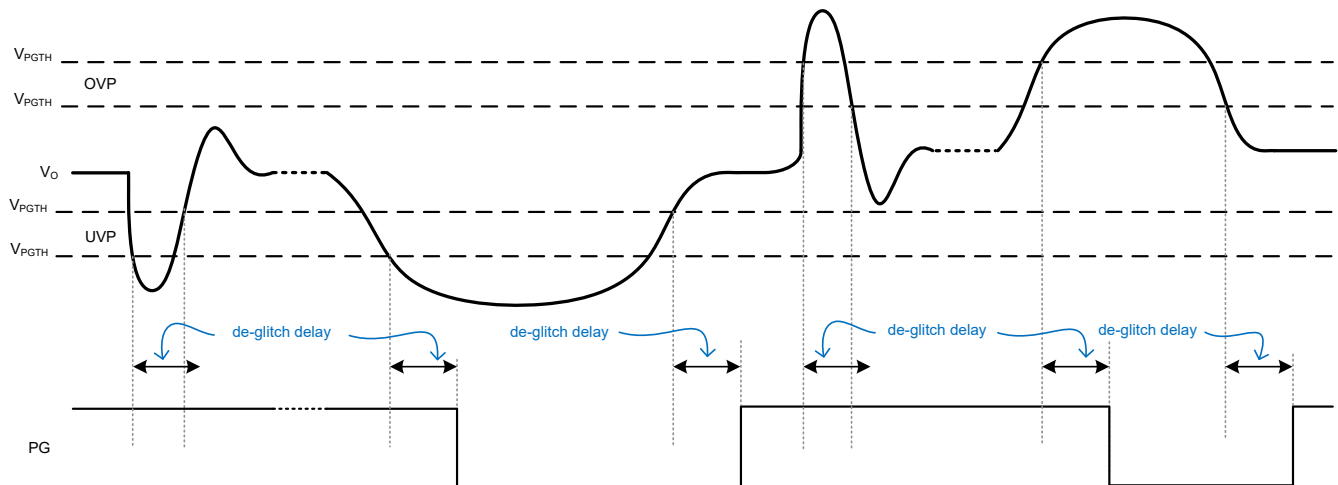

**Figure 7-7. Power-Good Behavior**

## 8 Application and Implementation

### Note

Information in the following applications sections is not part of the TI component specification, and TI does not warrant its accuracy or completeness. TI's customers are responsible for determining suitability of components for their purposes, as well as validating and testing their design implementation to confirm system functionality.

### 8.1 Application Information

The following section discusses the design of the external components to complete the power supply design for several input and output voltage options by using typical applications as a reference.

### 8.2 Typical Application

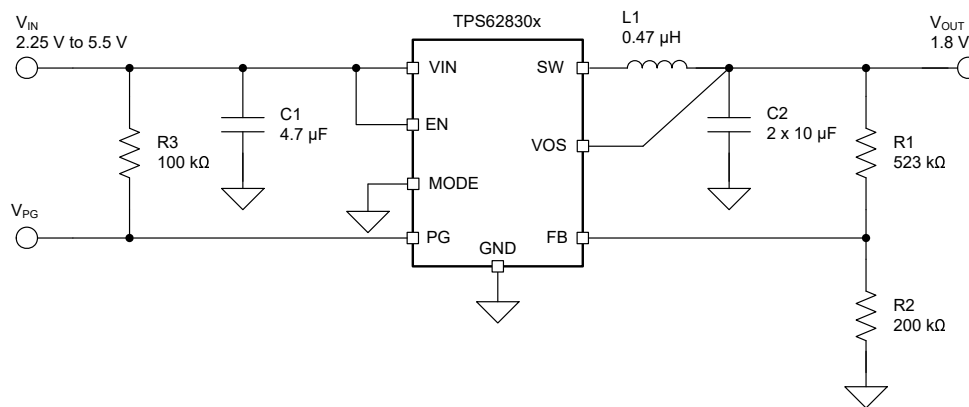

Figure 8-1. Typical Application of TPS62830x (Optimized for Design Size)

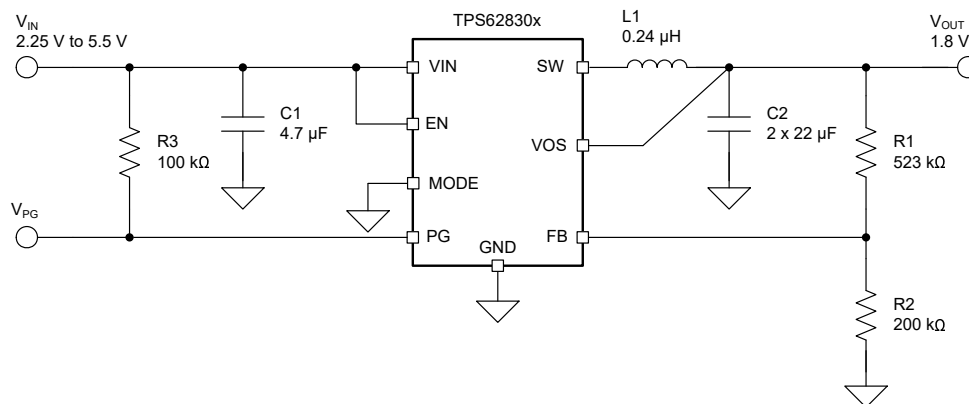

Figure 8-2. Typical Application of TPS62830x (Optimized for Transient Response)

#### 8.2.1 Design Requirements

For this design example, use the parameters listed in [Table 8-1](#) as the input parameters.

Table 8-1. Design Parameters

DESIGN PARAMETER	EXAMPLE VALUE
Input voltage	2.25 V to 5.5 V
Output voltage	1.8 V
Output ripple voltage	< 15 mV

Table 8-2 lists the components used for the example.

**Table 8-2. List of Components**

REFERENCE	DESCRIPTION	MANUFACTURER
C1	4.7 $\mu$ F, Ceramic capacitor, 6.3 V, X7R, size 0603, JMK107BB7475KA-T	Taiyo Yuden
C2	2 $\times$ 10 $\mu$ F, Ceramic capacitor, 10 V, X7R, size 0603, GRM188Z71A106KA73D	Murata
L1	0.47 $\mu$ H, Power inductor, XGL4015-471ME	Coilcraft
R1	Depending on the output voltage, 1%, size 0402	Std
R2	200 k $\Omega$ , Chip resistor, 1/16 W, 1%, size 0402	Std
R3	100 k $\Omega$ , Chip resistor, 1/16 W, 1%, size 0402	Std

## 8.2.2 Detailed Design Procedure

### 8.2.2.1 Custom Design With WEBENCH® Tools

[Click here](#) to create a custom design using the TPS62830x device with the WEBENCH® Power Designer.

1. Start by entering the input voltage ( $V_{IN}$ ), output voltage ( $V_{OUT}$ ), and output current ( $I_{OUT}$ ) requirements.
2. Optimize the design for key parameters such as efficiency, footprint, and cost using the optimizer dial.
3. Compare the generated design with other possible solutions from Texas Instruments.

The WEBENCH Power Designer provides a customized schematic along with a list of materials with real-time pricing and component availability.

In most cases, these actions are available:

- Run electrical simulations to see important waveforms and circuit performance
- Run thermal simulations to understand board thermal performance
- Export customized schematic and layout into popular CAD formats
- Print PDF reports for the design, and share the design with colleagues

Get more information about WEBENCH tools at [www.ti.com/WEBENCH](http://www.ti.com/WEBENCH).

### 8.2.2.2 Setting The Output Voltage

The output voltage is set by an external resistor divider according to [Equation 4](#):

$$R1 = R2 \times \left( \frac{V_{OUT}}{V_{FB}} - 1 \right) = R2 \times \left( \frac{V_{OUT}}{0.5V} - 1 \right) \quad (4)$$

R2 can be any value between 200 kΩ and 600 kΩ to achieve high efficiency at light load while providing acceptable noise sensitivity.

### 8.2.2.3 Inductor Selection

The main parameter for the inductor selection is the inductor value and then the saturation current of the inductor. To calculate the maximum inductor current under static load conditions, [Equation 5](#) and [Equation 6](#) are given.

$$I_{L,MAX} = I_{OUT,MAX} + \frac{\Delta I_L}{2} \quad (5)$$

$$\Delta I_L = V_{OUT} \times \frac{1 - \frac{V_{OUT}}{V_{IN}}}{L \times f_{SW}} \quad (6)$$

where:

- $I_{OUT,MAX}$  = Maximum output current
- $\Delta I_L$  = Inductor current ripple
- $f_{SW}$  = Switching frequency
- L = Inductor value

TI recommends to choose a saturation current for the inductor that is approximately 20% to 30% higher than  $I_{L,MAX}$ . In addition, DC resistance and size must also be taken into account when selecting an appropriate inductor. Finally, for better transient response performance, TI recommends a smaller inductance value. [Table 8-3](#) lists recommended inductors.



**Table 8-3. List of Recommended Inductors**

INDUCTANCE [μH]	CURRENT RATING [A]	DIMENSIONS [mm]	MAX. DC RESISTANCE [mΩ]	MFR PART NUMBER <sup>(1)</sup>
0.47	4.4	4.0 × 4.0 × 1.6	7.5	XGL4015-471ME, Coilcraft
	4.8	2.0 × 1.6 × 1.0	22	HTEN20161T-R47MDR, Cyntec
	4.8	2.0 × 1.6 × 1.0	22	CIGT201610EHR47MNE, Samsung
	5.1	2.0 × 1.6 × 1.0	34	TFM201610ALM-R47MTAA, TDK
0.24	4.8	2.0 × 1.25 × 0.8	17	LSCNE2012HKTR24MD, Taiyo Yuden
	4.7	2.0 × 1.6 × 1.0	19	CIGT201610LHR24MNE, Samsung
	4.7	2.0 × 1.6 × 1.0	20	DFE201610E-R24M, MuRata
	3.6	2.0 × 1.6 × 0.8	23	CIGT201608LMR24MNE, Samsung

(1) See the [Third-party Products Disclaimer](#).

### 8.2.2.4 Output Capacitor Selection

The inductor and the output capacitor together provide a low-pass filter. To simplify this process, [Table 8-5](#) outlines possible inductor and capacitor value combinations for most applications. Cells with the (✓) mark represent combinations that are proven for stability by simulation and lab test. additionally, cells with the (+) mark represent combinations that are proven for stability by simulation only. Check further combinations for each individual application.

The DCS-Control scheme of the TPS62830x allows the use of tiny ceramic capacitors. Ceramic capacitors with low ESR values have the lowest output voltage ripple and are recommended. To keep low resistance up to high frequencies and to get narrow capacitance variation with temperature, TI recommends using X7R or X5R dielectrics. At light load currents, the converter operates in Power Save Mode and the output voltage ripple is dependent on the output capacitor value. A larger output capacitors can be used reducing the output voltage ripple. Considering the DC-bias derating the capacitance, the recommended minimum effective output capacitance is 12 μF when using a 0.47-μH or larger inductor. When using a 0.24-μH or lower inductor, the recommended minimum effective output capacitance is 22 μF. [Table 8-6](#) lists recommended capacitors.

**Table 8-4. Matrix of Output Capacitor and Inductor Combinations (TPS628301 and TPS628302)**

V <sub>OUT</sub> [V]	NOMINAL L [μH] <sup>(2)</sup>	NOMINAL C <sub>OUT</sub> [μF] <sup>(3)</sup>		
		2 × 10 or 22	2 × 22 or 47	100
0.5 ≤ V <sub>OUT</sub> ≤ 1.8	0.47	✓ <sup>(1)</sup>	✓	+
	1.0	+	+	
1.8 < V <sub>OUT</sub>	0.47		✓ <sup>(1)</sup>	+
	1.0	+	+	

**Table 8-5. Matrix of Output Capacitor and Inductor Combinations (TPS628303 and TPS628304)**

V <sub>OUT</sub> [V]	NOMINAL L [μH] <sup>(2)</sup>	NOMINAL C <sub>OUT</sub> [μF] <sup>(3)</sup>		
		2 × 10 or 22	2 × 22 or 47	100
0.5 ≤ V <sub>OUT</sub> ≤ 1.8	0.47	✓ <sup>(1)</sup>	✓	+
	0.24	+	✓	+
1.8 < V <sub>OUT</sub>	0.47		✓ <sup>(1)</sup>	+
	0.24		✓	+

(1) This LC combination is the standard value and recommended for most applications.

(2) Inductor tolerance and current derating is anticipated. The effective inductance can vary by 20% and –30%.

(3) Capacitance tolerance and bias voltage derating is anticipated. The effective capacitance can vary by 20% and –50%.

**Table 8-6. List of Recommended Capacitors**

NOMINAL CAPACITANCE [μF]	VOLTAGE RATING [V]	DIMENSIONS [mm]	MFR PART NUMBER <sup>(1)</sup>
10	6.3	2.0 × 1.5 × 1.25	MSASJ21GAB7106MTNA01, Taiyo Yuden
10	10	2.0 × 1.25 × 1.25	C2012X7R1A106K125AC, TDK
10	10	1.6 × 0.8 × 0.8	GRM188Z71A106KA73#, MuRata
10	10	1.6 × 0.8 × 0.8	C1608X5R1A106K080AC, TDK
22	10	2.0 × 1.25 × 1.25	GRM21BZ71A226ME15#, MuRata
22	10	1.6 × 0.8 × 0.8	C1608X5R1A226M080AC, TDK

### 8.2.2.5 Input Capacitor Selection

The input capacitor is the low-impedance energy source for the converter, which helps provide stable operation. Because the buck converter has a pulsating input current, a low ESR ceramic input capacitor is required for best input voltage filtering to minimize input voltage spikes. Place the capacitor between VIN and GND pins and as close as possible to those pins.

For most applications, a minimum effective input capacitance of 3 μF is sufficient, though a larger value reduces input current ripple and is recommended. When operating from a high impedance source, TI recommends a larger input buffer capacitor ≥10 μF to avoid voltage drops during start-up and load transients. Additionally, small de-coupling capacitors can also be used in case of noise at the input if the device. The input capacitor can be increased without any limit for better input voltage filtering.

Table 8-7 shows a list of recommended capacitors.

**Table 8-7. List of Recommended Capacitors**

NOMINAL CAPACITANCE [μF]	VOLTAGE RATING [V]	DIMENSIONS [mm]	MFR PART NUMBER <sup>(1)</sup>
4.7	6.3	1.6 × 0.8 × 0.8	MSASJ168BB7475MTNA01, Taiyo Yuden
4.7	10	2.0 × 1.25 × 1.25	C2012X7R1A475K125AC, TDK
10	10	1.6 × 0.8 × 0.8	GRM188Z71A106KA73#, MuRata

(1) See the [Third-party Products Disclaimer](#)

### 8.2.3 Application Curves

$T_A = 25^\circ\text{C}$ ,  $V_{IN} = 5\text{ V}$ ,  $V_{OUT} = 1.8\text{ V}$ , BOM = [Table 8-2](#) unless otherwise noted.

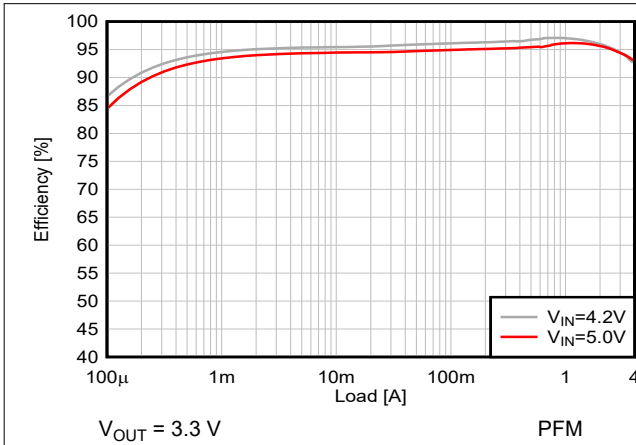

**Figure 8-3. Efficiency versus Output Current**

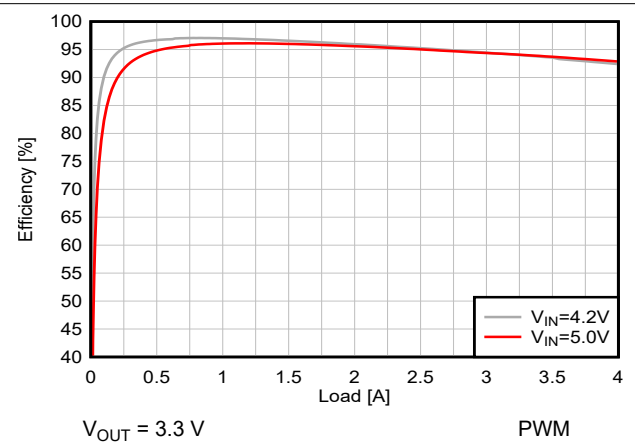

**Figure 8-4. Efficiency versus Output Current**

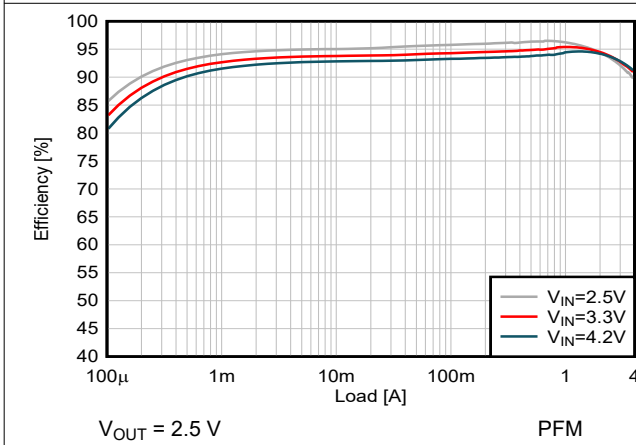

**Figure 8-5. Efficiency versus Output Current**

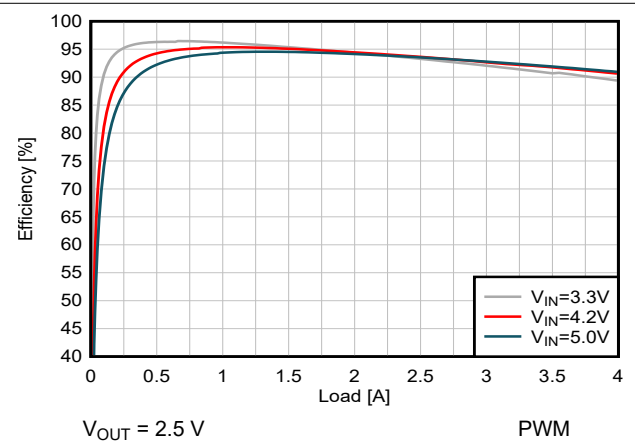

**Figure 8-6. Efficiency versus Output Current**

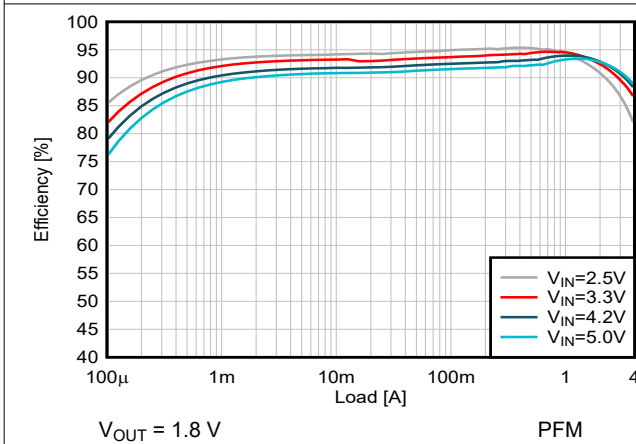

**Figure 8-7. Efficiency versus Output Current**

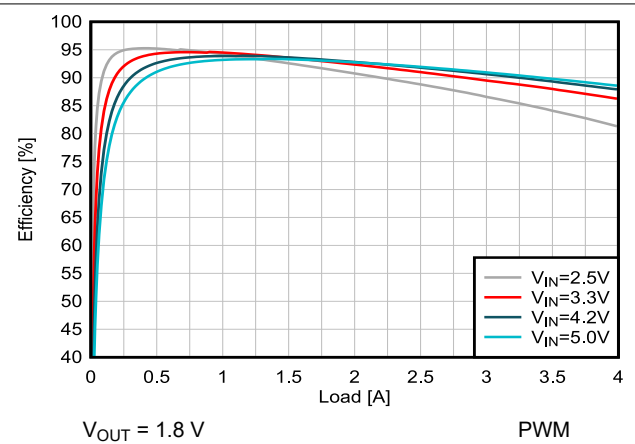

**Figure 8-8. Efficiency versus Output Current**

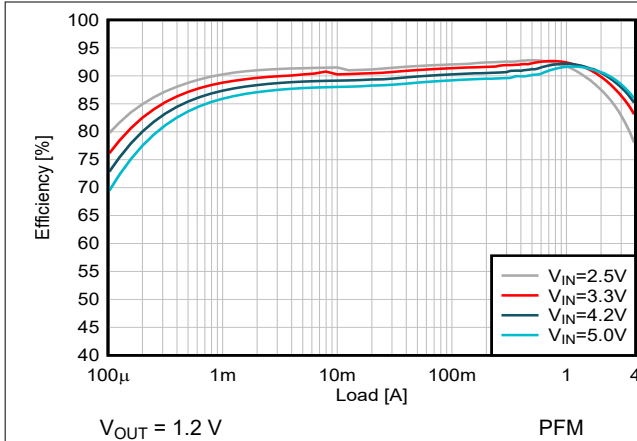

**Figure 8-9. Efficiency versus Output Current**

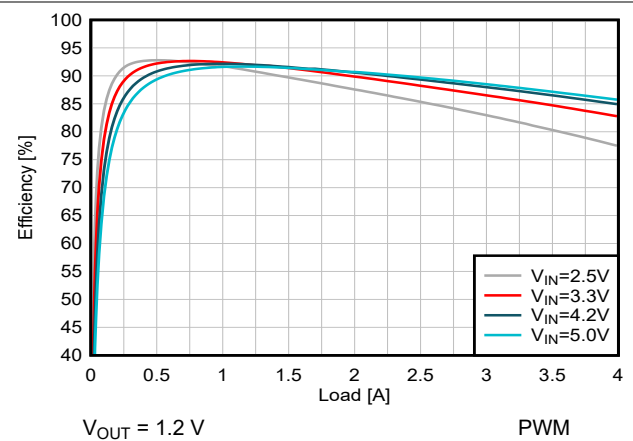

**Figure 8-10. Efficiency versus Output Current**

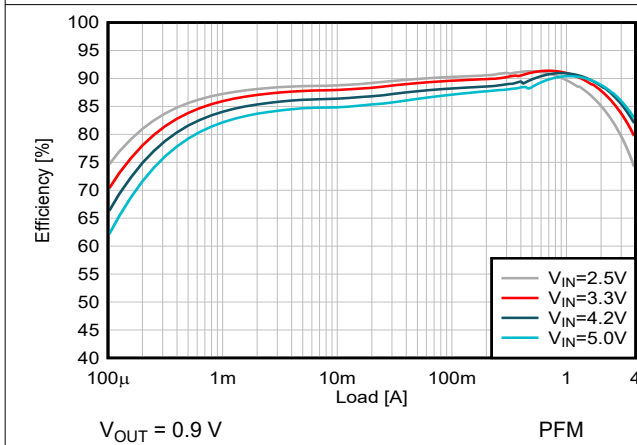

**Figure 8-11. Efficiency versus Output Current**

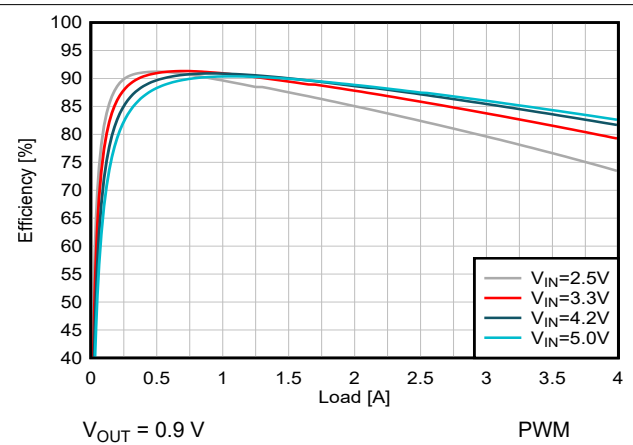

**Figure 8-12. Efficiency versus Output Current**

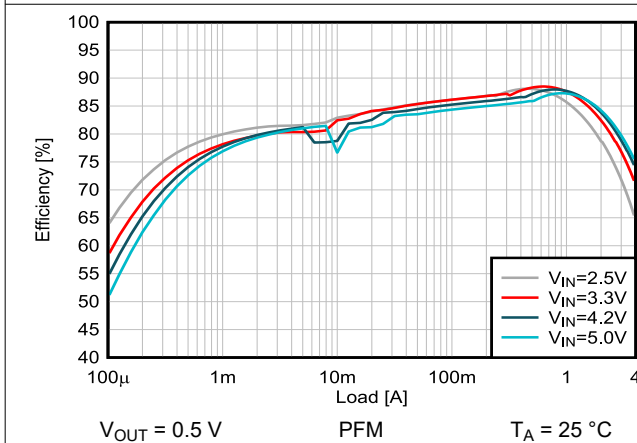

**Figure 8-13. Efficiency versus Output Current**

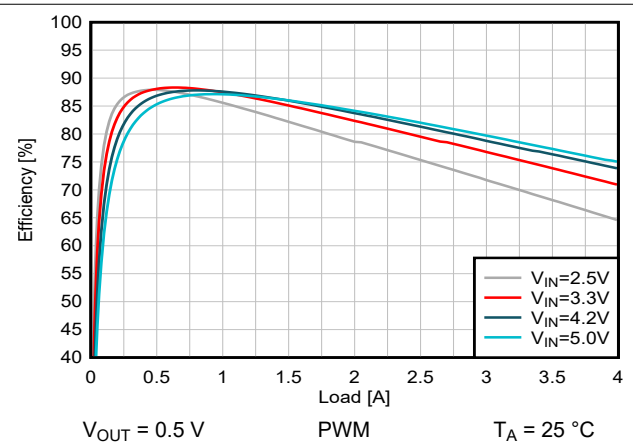

**Figure 8-14. Efficiency versus Output Current**

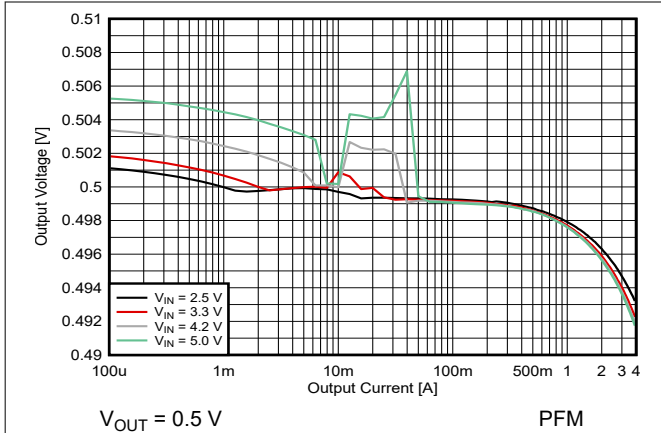

**Figure 8-15. Output Voltage versus Output Current**

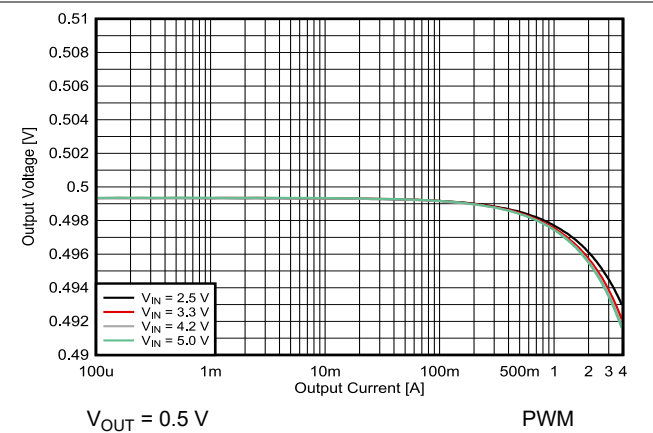

**Figure 8-16. Output Voltage versus Output Current**

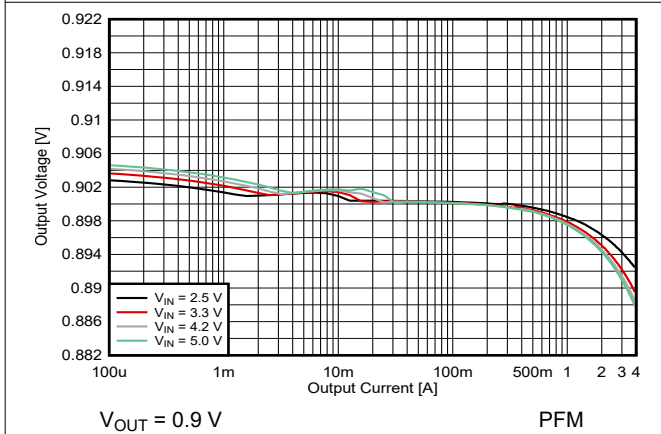

**Figure 8-17. Output Voltage versus Output Current**

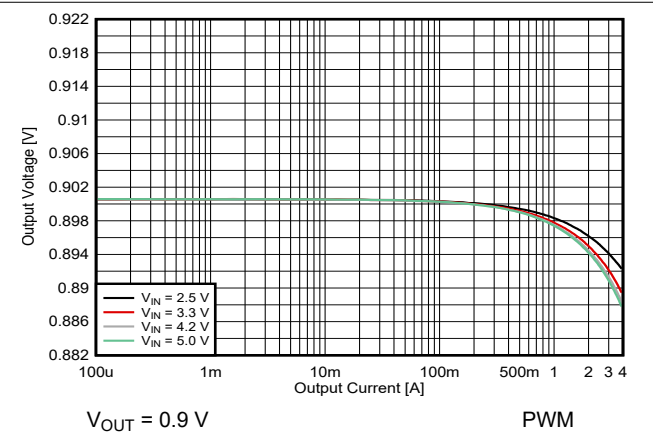

**Figure 8-18. Output Voltage versus Output Current**

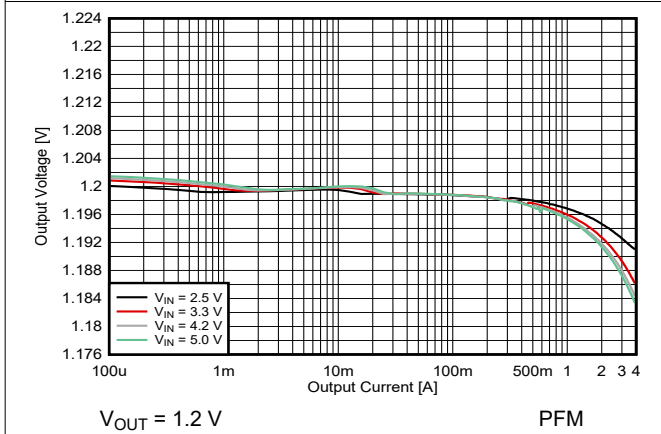

**Figure 8-19. Output Voltage versus Output Current**

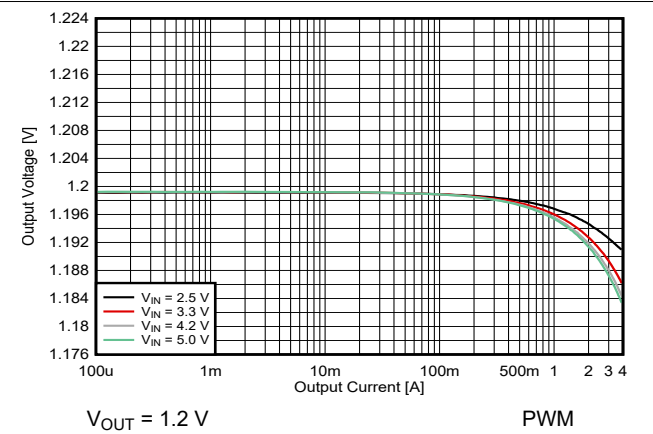

**Figure 8-20. Output Voltage versus Output Current**

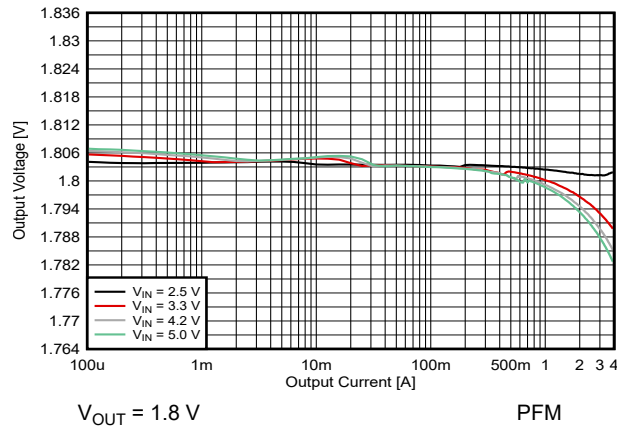

**Figure 8-21. Output Voltage versus Output Current**

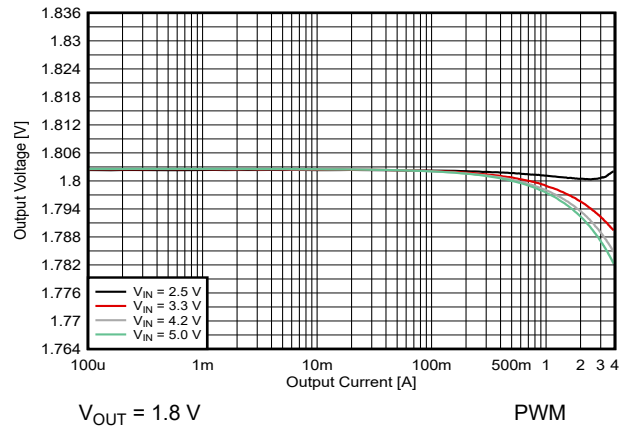

**Figure 8-22. Output Voltage versus Output Current**

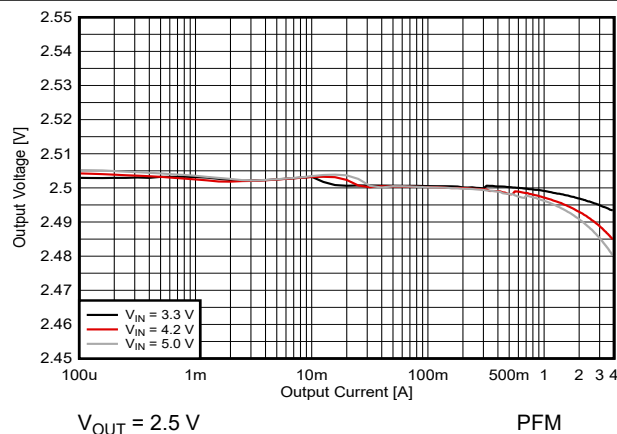

**Figure 8-23. Output Voltage versus Output Current**

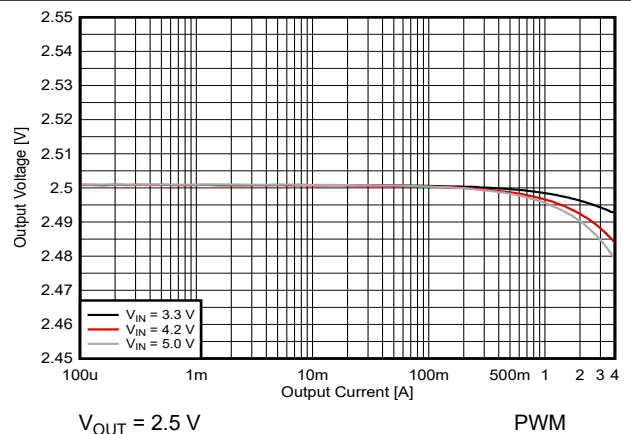

**Figure 8-24. Output Voltage versus Output Current**

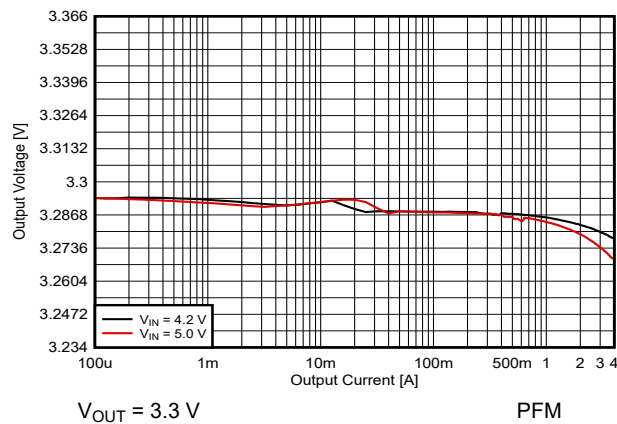

**Figure 8-25. Output Voltage versus Output Current**

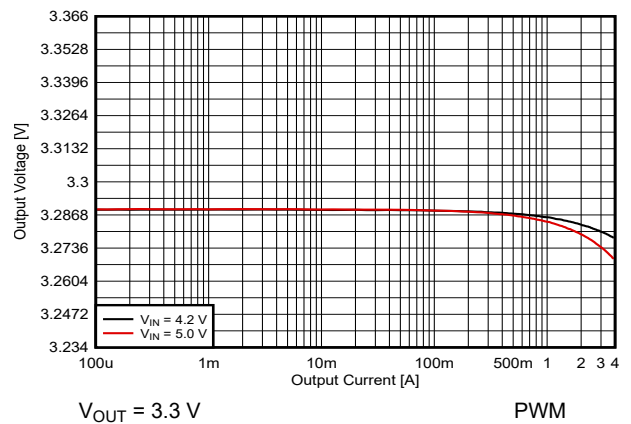

**Figure 8-26. Output Voltage versus Output Current**

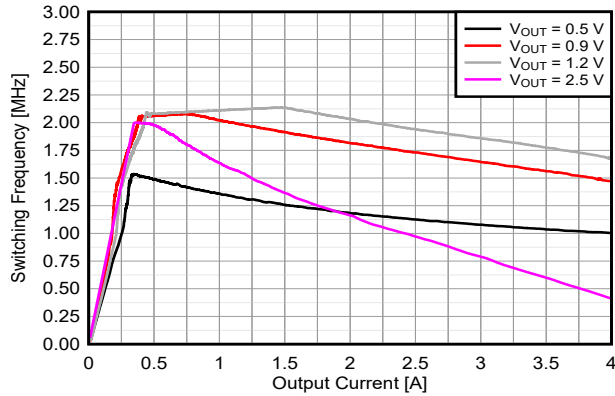

$V_{IN} = 3.3\text{ V}$  PFM  
**Figure 8-27. Switching Frequency versus Output Current**

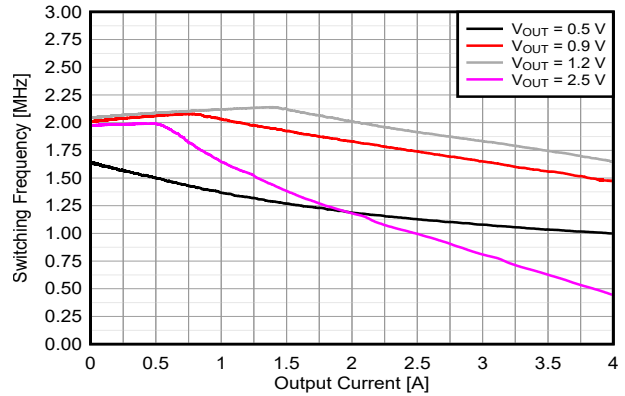

$V_{IN} = 3.3\text{ V}$  PWM  
**Figure 8-28. Switching Frequency versus Output Current**

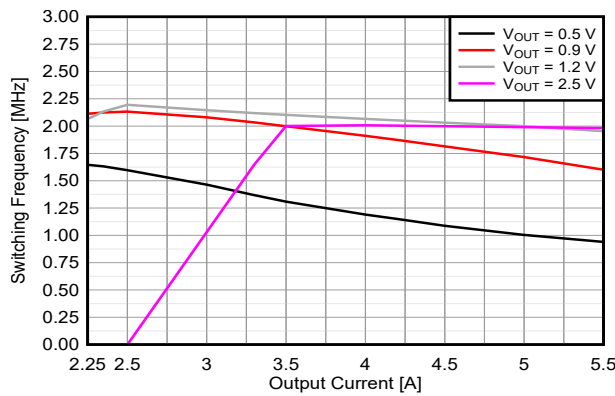

$I_{OUT} = 1\text{ A}$   
**Figure 8-29. Switching Frequency versus Input Voltage**

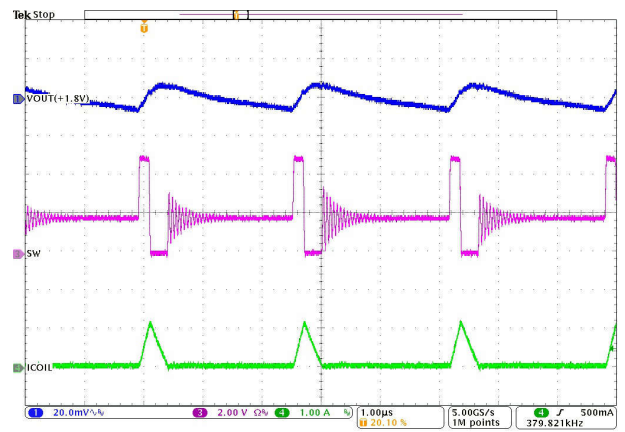

$I_{OUT} = 100\text{ mA}$  PFM  
**Figure 8-30. Output Voltage Ripple**

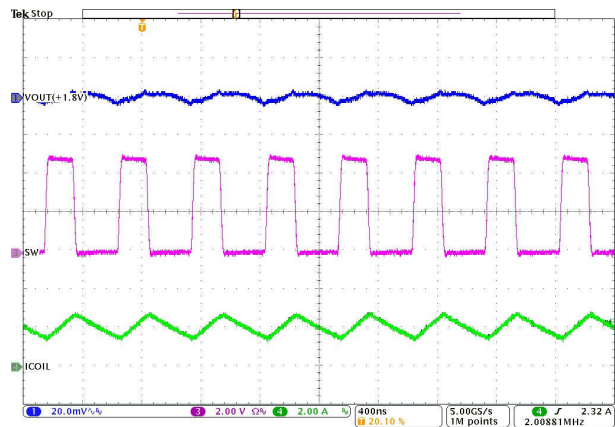

$I_{OUT} = 2.0\text{ A}$  PFM or PWM  
**Figure 8-31. Output Voltage Ripple**

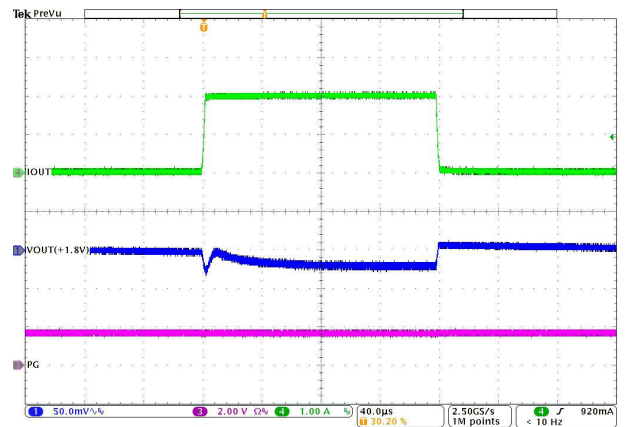

$I_{OUT} = 1\text{ mA to }2\text{ A}$  PFM Slew rate =  $1\text{ A}/\mu\text{s}$   
**Figure 8-32. Load Transient**

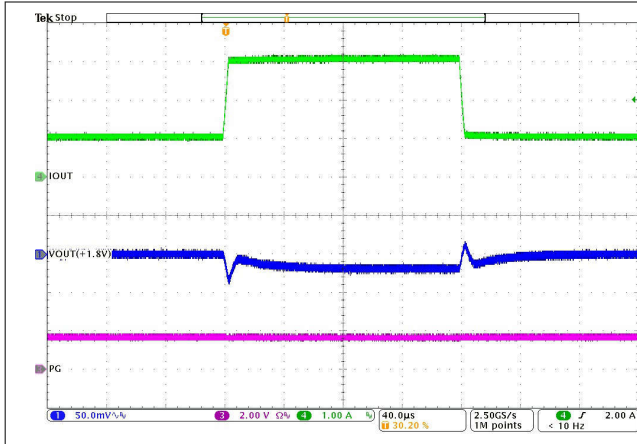

$I_{OUT} = 1\text{ A to }3\text{ A}$       PWM      Slew rate =  $1\text{ A}/\mu\text{s}$

**Figure 8-33. Load Transient**

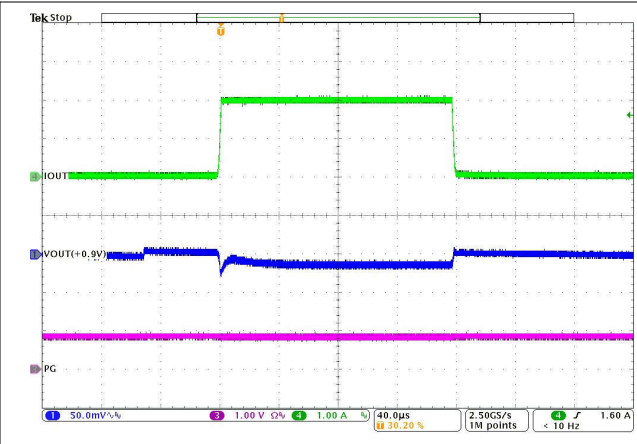

$V_{IN} = 3.3\text{ V}$       PFM       $I_{OUT} = 1\text{ mA to }2\text{ A}$   
 $V_{OUT} = 0.9\text{ V}$       Transient BoM      Slew rate =  $1\text{ A}/\mu\text{s}$

**Figure 8-34. Load Transient**

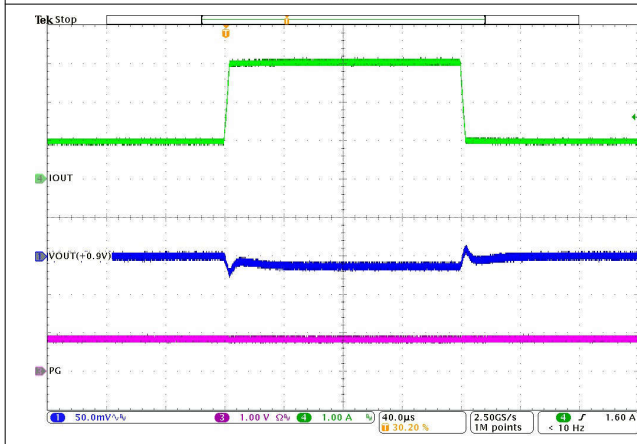

$V_{IN} = 3.3\text{ V}$       PWM       $I_{OUT} = 1\text{ A to }3\text{ A}$   
 $V_{OUT} = 0.9\text{ V}$       Transient BoM      Slew rate =  $1\text{ A}/\mu\text{s}$

**Figure 8-35. Load Transient**

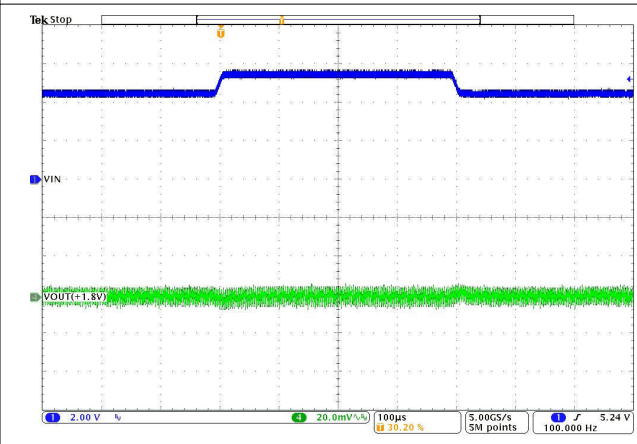

$V_{IN} = 4.5\text{ V to }5.5\text{ V}$       PFM       $I_{OUT} = 100\text{ mA}$

**Figure 8-36. Line Transient**

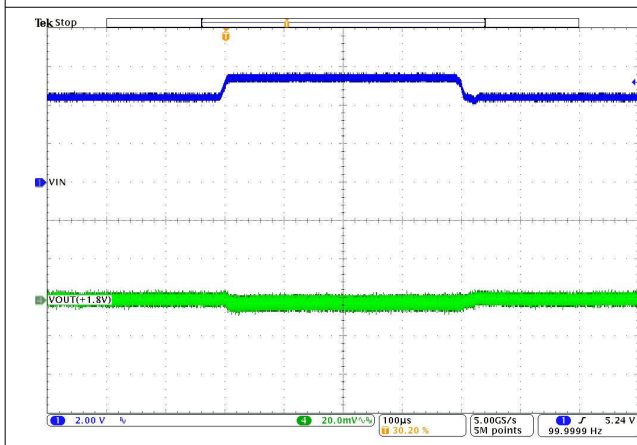

$V_{IN} = 4.5\text{ V to }5.5\text{ V}$       PWM       $I_{OUT} = 2.0\text{ A}$

**Figure 8-37. Line Transient**

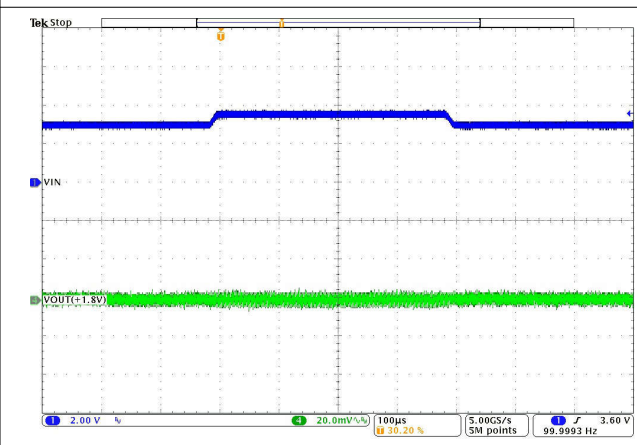

$V_{IN} = 3.0\text{ V to }3.6\text{ V}$       PFM       $I_{OUT} = 100\text{ mA}$

**Figure 8-38. Line Transient**



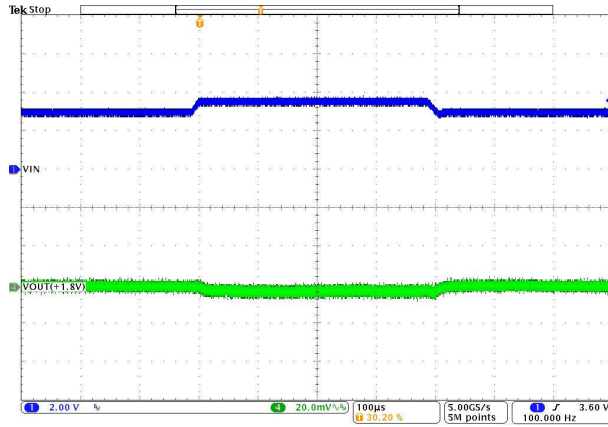

$V_{IN} = 3.0\text{ V to } 3.6\text{ V}$       PWM       $I_{OUT} = 2.0\text{ A}$

**Figure 8-39. Line Transient**

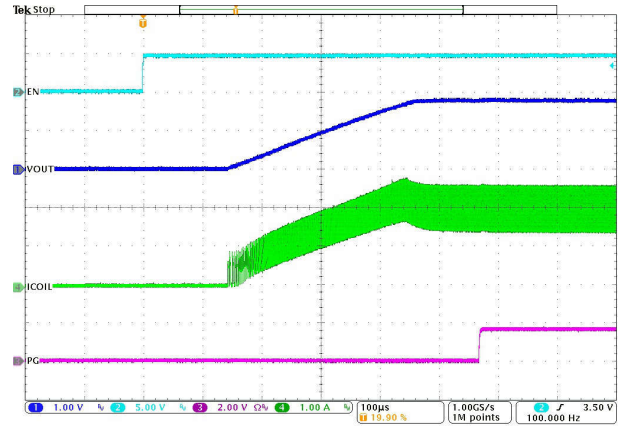

$I_{OUT} = 2.0\text{ A}$       PFM or PWM       $T_A = 25\text{ }^\circ\text{C}$

'A' and 'B' versions

**Figure 8-40. Start-Up With Load**

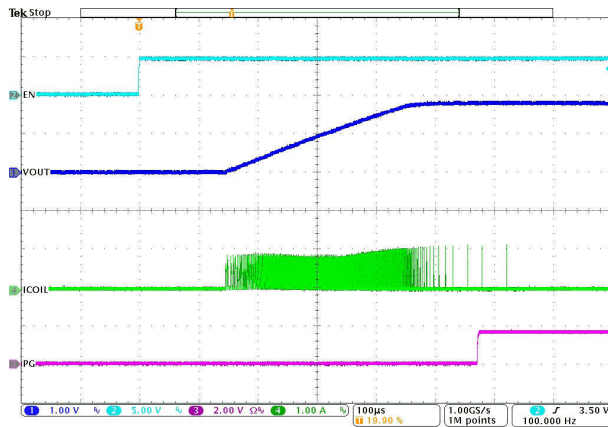

$I_{OUT} = 0\text{ mA}$       PFM or PWM       $T_A = 25\text{ }^\circ\text{C}$

'A' and 'B' versions

**Figure 8-41. Start-Up With No Load**

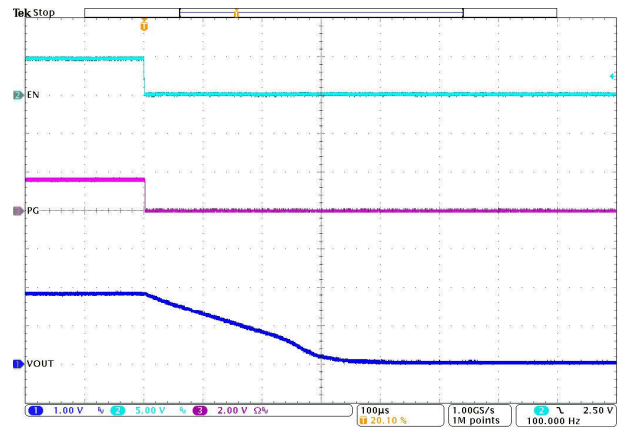

$I_{OUT} = 0\text{ mA}$       PFM       $T_A = 25\text{ }^\circ\text{C}$

**Figure 8-42. Disable, Active Output Discharge at No Load**

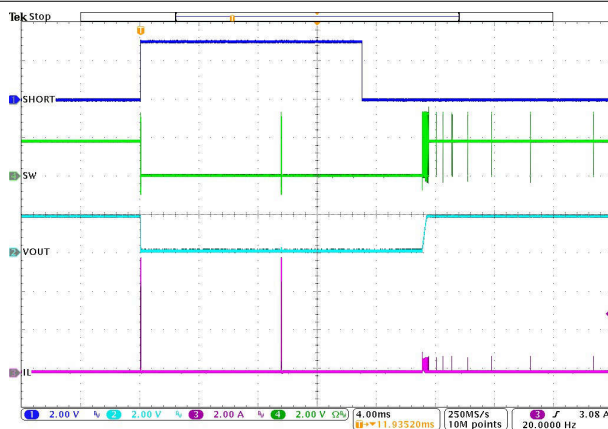

PFM or PWM       $T_A = 25\text{ }^\circ\text{C}$

**Figure 8-43. HICCUP Short-Circuit Protection**

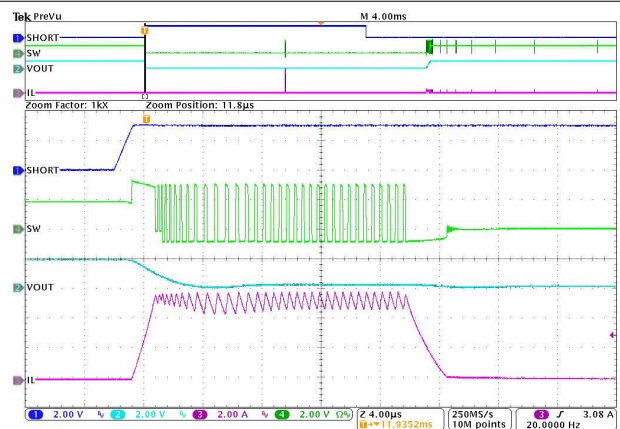

PFM or PWM

$T_A = 25\text{ }^\circ\text{C}$

**Figure 8-44. HICCUP Short-Circuit Protection (Zoom In)**

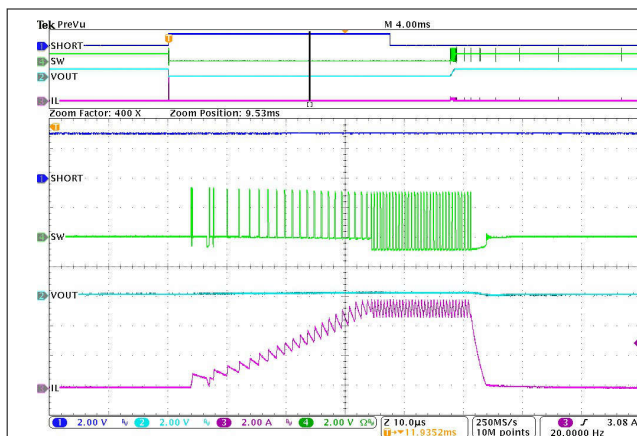
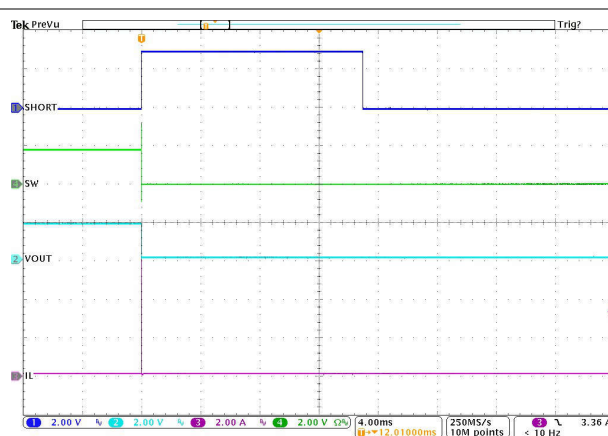
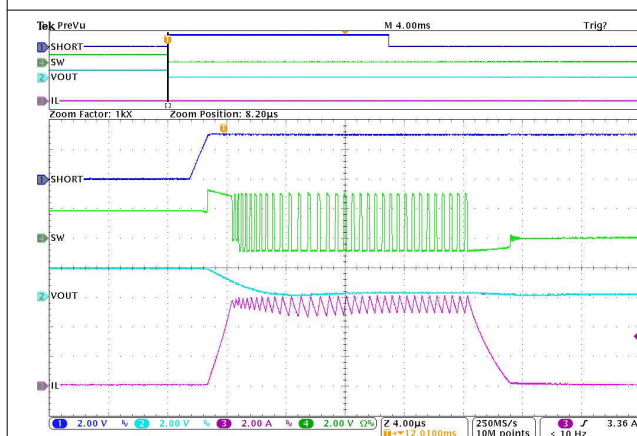
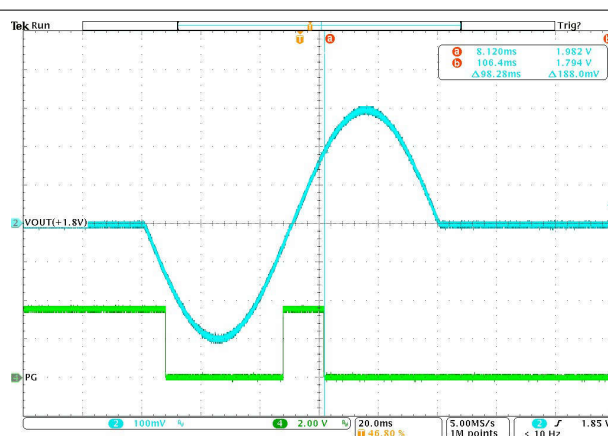
 PFM or PWM  $T_A = 25\text{ }^\circ\text{C}$ 
**Figure 8-45. HICCUP Short-Circuit Protection (Zoom In - Second Hiccup)**

 PFM or PWM  $T_A = 25\text{ }^\circ\text{C}$ 
**Figure 8-46. Latch-off Short-Circuit Protection**

 PFM or PWM  $T_A = 25\text{ }^\circ\text{C}$ 
**Figure 8-47. Latch-off Short-Circuit Protection (Zoom In)**

 PFM or PWM  $T_A = 25\text{ }^\circ\text{C}$ 
**Figure 8-48. Latch-off Overvoltage Protection**

## 8.3 Power Supply Recommendations

The TPS62830x family does not have special requirements for the input power supply and is designed to operate from an input voltage supply range from 2.25 V to 5.5 V. The output current of the input power supply must be rated according to the supply voltage, output voltage, and output current of the device.

## 8.4 Layout

### 8.4.1 Layout Guidelines

The printed-circuit-board (PCB) layout is an important step to maintain the high performance of the device. See [Layout Example](#) for the recommended low EMI PCB layout.

- Place the input and output capacitors and the inductor as close as possible to the IC. This action keeps the power traces short. Routing these power traces direct and wide results in low trace resistance and low parasitic inductance.
- Connect the low side of the input and output capacitors properly to the GND pin to avoid a ground potential shift.

- Take special care to avoid noise being induced. The sense traces connected to FB is a signal trace. Keep these traces away from SW nodes. The connection of the output voltage trace for the FB resistors must be made at the output capacitor.
- Refer to [Layout Example](#) for an example of component placement, routing, and thermal design with good EMI performance.

### 8.4.2 Layout Example

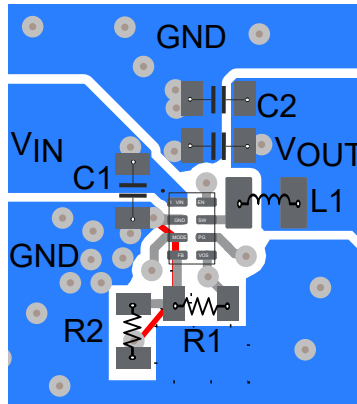

Figure 8-49. PCB Layout Recommendation (RZE Package)

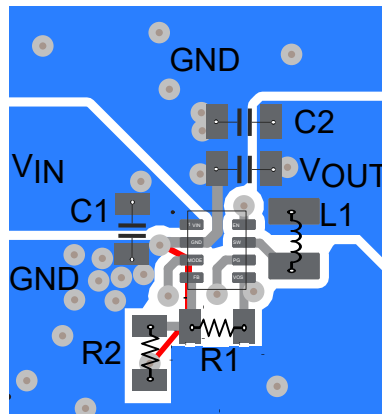

Figure 8-50. PCB Layout Recommendation (DRL Package)

#### 8.4.2.1 Thermal Considerations

Implementation of integrated circuits in low-profile and fine-pitch surface-mount packages typically requires special attention to power dissipation. Many system-dependent issues such as thermal coupling, airflow, added heat sinks and convection surfaces, and the presence of other heat-generating components affect the power dissipation limits of a given component.

Two basic approaches for enhancing thermal performance are:

- Improving the power dissipation capability of the PCB design
- Introducing airflow in the system

The Thermal Data section in [Thermal Information](#) provides the thermal metric of the device on the EVM after considering the PCB design of real applications. The big copper planes connecting to the pads of the IC on the PCB improve the thermal performance of the device. For more details on how to use the thermal parameters, see the Thermal Characteristics application notes, [Thermal Characteristics of Linear and Logic Packages Using JEDEC PCB Designs](#) and [Semiconductor and IC Package Thermal Metrics](#).

## 9 Device and Documentation Support

### 9.1 Device Support

#### 9.1.1 Third-Party Products Disclaimer

TI'S PUBLICATION OF INFORMATION REGARDING THIRD-PARTY PRODUCTS OR SERVICES DOES NOT CONSTITUTE AN ENDORSEMENT REGARDING THE SUITABILITY OF SUCH PRODUCTS OR SERVICES OR A WARRANTY, REPRESENTATION OR ENDORSEMENT OF SUCH PRODUCTS OR SERVICES, EITHER ALONE OR IN COMBINATION WITH ANY TI PRODUCT OR SERVICE.

#### 9.1.2 Development Support

##### 9.1.2.1 Custom Design With WEBENCH® Tools

[Click here](#) to create a custom design using the TPS62830x device with the WEBENCH® Power Designer.

1. Start by entering the input voltage ( $V_{IN}$ ), output voltage ( $V_{OUT}$ ), and output current ( $I_{OUT}$ ) requirements.
2. Optimize the design for key parameters such as efficiency, footprint, and cost using the optimizer dial.
3. Compare the generated design with other possible solutions from Texas Instruments.

The WEBENCH Power Designer provides a customized schematic along with a list of materials with real-time pricing and component availability.

In most cases, these actions are available:

- Run electrical simulations to see important waveforms and circuit performance
- Run thermal simulations to understand board thermal performance
- Export customized schematic and layout into popular CAD formats
- Print PDF reports for the design, and share the design with colleagues

Get more information about WEBENCH tools at [www.ti.com/WEBENCH](http://www.ti.com/WEBENCH).

### 9.2 Documentation Support

#### 9.2.1 Related Documentation

For related documentation, see the following:

- Texas Instruments, [Thermal Characteristics of Linear and Logic Packages Using JEDEC PCB Designs](#) application note
- Texas Instruments, [Semiconductor and IC Package Thermal Metrics](#) application note

### 9.3 Support Resources

[TI E2E™ support forums](#) are an engineer's go-to source for fast, verified answers and design help — straight from the experts. Search existing answers or ask your own question to get the quick design help you need.

Linked content is provided "AS IS" by the respective contributors. They do not constitute TI specifications and do not necessarily reflect TI's views; see TI's [Terms of Use](#).

### 9.4 Trademarks

TI E2E™ is a trademark of Texas Instruments.

All trademarks are the property of their respective owners.

### 9.5 Electrostatic Discharge Caution



This integrated circuit can be damaged by ESD. Texas Instruments recommends that all integrated circuits be handled with appropriate precautions. Failure to observe proper handling and installation procedures can cause damage.

ESD damage can range from subtle performance degradation to complete device failure. Precision integrated circuits may be more susceptible to damage because very small parametric changes could cause the device not to meet its published specifications.

### 9.6 Glossary

[TI Glossary](#) This glossary lists and explains terms, acronyms, and definitions.

## 10 Revision History

<b>Changes from Revision A (October 2023) to Revision B (March 2024)</b>	<b>Page</b>
--	-------------

- Added new orderable part number information throughout the data sheet..... **1**
- 

<b>Changes from Revision * (February 2023) to Revision A (October 2023)</b>	<b>Page</b>
---	-------------

- Changed document status from Advance Information to Production Data..... **1**
- 

## 11 Mechanical, Packaging, and Orderable Information

The following pages include mechanical, packaging, and orderable information. This information is the most current data available for the designated devices. This data is subject to change without notice and revision of this document. For browser-based versions of this data sheet, refer to the left-hand navigation.

**PACKAGING INFORMATION**

Orderable Device	Status (1)	Package Type	Package Drawing	Pins	Package Qty	Eco Plan (2)	Lead finish/ Ball material (6)	MSL Peak Temp (3)	Op Temp (°C)	Device Marking (4/5)	Samples
TPS628301ADRLR	ACTIVE	SOT-5X3	DRL	8	4000	RoHS & Green	Call TI   SN	Level-1-260C-UNLIM	-40 to 125	01A	<a href="#">Samples</a>
TPS628301ARZER	ACTIVE	WQFN-HR	RZE	8	3000	RoHS & Green	SN	Level-2-260C-1 YEAR	-40 to 125	01A	<a href="#">Samples</a>
TPS628301KRZER	ACTIVE	WQFN-HR	RZE	8	3000	RoHS & Green	SN	Level-1-260C-UNLIM	-40 to 125	01K	<a href="#">Samples</a>
TPS628302ADRLR	ACTIVE	SOT-5X3	DRL	8	4000	RoHS & Green	Call TI   SN	Level-1-260C-UNLIM	-40 to 125	02A	<a href="#">Samples</a>
TPS628302ARZER	ACTIVE	WQFN-HR	RZE	8	3000	RoHS & Green	SN	Level-2-260C-1 YEAR	-40 to 125	02A	<a href="#">Samples</a>
TPS628302KRZER	ACTIVE	WQFN-HR	RZE	8	3000	RoHS & Green	SN	Level-1-260C-UNLIM	-40 to 125	02K	<a href="#">Samples</a>
TPS628303ADRLR	ACTIVE	SOT-5X3	DRL	8	4000	RoHS & Green	Call TI   SN	Level-1-260C-UNLIM	-40 to 125	03A	<a href="#">Samples</a>
TPS628303ARZER	ACTIVE	WQFN-HR	RZE	8	3000	RoHS & Green	SN	Level-2-260C-1 YEAR	-40 to 125	03A	<a href="#">Samples</a>
TPS628303BDRLR	ACTIVE	SOT-5X3	DRL	8	4000	RoHS & Green	Call TI   SN	Level-1-260C-UNLIM	-40 to 125	03B	<a href="#">Samples</a>
TPS628303KRZER	ACTIVE	WQFN-HR	RZE	8	3000	RoHS & Green	SN	Level-1-260C-UNLIM	-40 to 125	03K	<a href="#">Samples</a>
TPS628304ADRLR	ACTIVE	SOT-5X3	DRL	8	4000	RoHS & Green	Call TI   SN	Level-1-260C-UNLIM	-40 to 125	04A	<a href="#">Samples</a>
TPS628304ARZER	ACTIVE	WQFN-HR	RZE	8	3000	RoHS & Green	SN	Level-2-260C-1 YEAR	-40 to 125	04A	<a href="#">Samples</a>
TPS628304KRZER	ACTIVE	WQFN-HR	RZE	8	3000	RoHS & Green	SN	Level-1-260C-UNLIM		04K	<a href="#">Samples</a>

(1) The marketing status values are defined as follows:

**ACTIVE:** Product device recommended for new designs.

**LIFEBUY:** TI has announced that the device will be discontinued, and a lifetime-buy period is in effect.

**NRND:** Not recommended for new designs. Device is in production to support existing customers, but TI does not recommend using this part in a new design.

**PREVIEW:** Device has been announced but is not in production. Samples may or may not be available.

**OBSELETE:** TI has discontinued the production of the device.

(2) **RoHS:** TI defines "RoHS" to mean semiconductor products that are compliant with the current EU RoHS requirements for all 10 RoHS substances, including the requirement that RoHS substance do not exceed 0.1% by weight in homogeneous materials. Where designed to be soldered at high temperatures, "RoHS" products are suitable for use in specified lead-free processes. TI may reference these types of products as "Pb-Free".

**RoHS Exempt:** TI defines "RoHS Exempt" to mean products that contain lead but are compliant with EU RoHS pursuant to a specific EU RoHS exemption.

**Green:** TI defines "Green" to mean the content of Chlorine (Cl) and Bromine (Br) based flame retardants meet JS709B low halogen requirements of <=1000ppm threshold. Antimony trioxide based flame retardants must also meet the <=1000ppm threshold requirement.

- (3) MSL, Peak Temp. - The Moisture Sensitivity Level rating according to the JEDEC industry standard classifications, and peak solder temperature.
- (4) There may be additional marking, which relates to the logo, the lot trace code information, or the environmental category on the device.
- (5) Multiple Device Markings will be inside parentheses. Only one Device Marking contained in parentheses and separated by a "~" will appear on a device. If a line is indented then it is a continuation of the previous line and the two combined represent the entire Device Marking for that device.
- (6) Lead finish/Ball material - Orderable Devices may have multiple material finish options. Finish options are separated by a vertical ruled line. Lead finish/Ball material values may wrap to two lines if the finish value exceeds the maximum column width.

**Important Information and Disclaimer:**The information provided on this page represents TI's knowledge and belief as of the date that it is provided. TI bases its knowledge and belief on information provided by third parties, and makes no representation or warranty as to the accuracy of such information. Efforts are underway to better integrate information from third parties. TI has taken and continues to take reasonable steps to provide representative and accurate information but may not have conducted destructive testing or chemical analysis on incoming materials and chemicals. TI and TI suppliers consider certain information to be proprietary, and thus CAS numbers and other limited information may not be available for release.

In no event shall TI's liability arising out of such information exceed the total purchase price of the TI part(s) at issue in this document sold by TI to Customer on an annual basis.



**TAPE AND REEL INFORMATION**

**QUADRANT ASSIGNMENTS FOR PIN 1 ORIENTATION IN TAPE**

\*All dimensions are nominal

Device	Package Type	Package Drawing	Pins	SPQ	Reel Diameter (mm)	Reel Width W1 (mm)	A0 (mm)	B0 (mm)	K0 (mm)	P1 (mm)	W (mm)	Pin1 Quadrant
TPS628301ADRLR	SOT-5X3	DRL	8	4000	180.0	8.4	2.75	1.9	0.8	4.0	8.0	Q3
TPS628301ARZER	WQFN-HR	RZE	8	3000	180.0	8.4	1.3	2.3	0.9	4.0	8.0	Q1
TPS628301KRZER	WQFN-HR	RZE	8	3000	180.0	8.4	1.3	2.3	0.9	4.0	8.0	Q1
TPS628302ADRLR	SOT-5X3	DRL	8	4000	180.0	8.4	2.75	1.9	0.8	4.0	8.0	Q3
TPS628302ARZER	WQFN-HR	RZE	8	3000	180.0	8.4	1.3	2.3	0.9	4.0	8.0	Q1
TPS628302KRZER	WQFN-HR	RZE	8	3000	180.0	8.4	1.3	2.3	0.9	4.0	8.0	Q1
TPS628303ADRLR	SOT-5X3	DRL	8	4000	180.0	8.4	2.75	1.9	0.8	4.0	8.0	Q3
TPS628303ARZER	WQFN-HR	RZE	8	3000	180.0	8.4	1.3	2.3	0.9	4.0	8.0	Q1
TPS628303BDRLR	SOT-5X3	DRL	8	4000	180.0	8.4	2.75	1.9	0.8	4.0	8.0	Q3
TPS628303KRZER	WQFN-HR	RZE	8	3000	180.0	8.4	1.3	2.3	0.9	4.0	8.0	Q1
TPS628304ADRLR	SOT-5X3	DRL	8	4000	180.0	8.4	2.75	1.9	0.8	4.0	8.0	Q3



Device	Package Type	Package Drawing	Pins	SPQ	Reel Diameter (mm)	Reel Width W1 (mm)	A0 (mm)	B0 (mm)	K0 (mm)	P1 (mm)	W (mm)	Pin1 Quadrant
TPS628304ARZER	WQFN-HR	RZE	8	3000	180.0	8.4	1.3	2.3	0.9	4.0	8.0	Q1
TPS628304KRZER	WQFN-HR	RZE	8	3000	180.0	8.4	1.3	2.3	0.9	4.0	8.0	Q1

## TAPE AND REEL BOX DIMENSIONS



\*All dimensions are nominal

Device	Package Type	Package Drawing	Pins	SPQ	Length (mm)	Width (mm)	Height (mm)
TPS628301ADRLR	SOT-5X3	DRL	8	4000	210.0	185.0	35.0
TPS628301ARZER	WQFN-HR	RZE	8	3000	210.0	185.0	35.0
TPS628301KRZER	WQFN-HR	RZE	8	3000	210.0	185.0	35.0
TPS628302ADRLR	SOT-5X3	DRL	8	4000	210.0	185.0	35.0
TPS628302ARZER	WQFN-HR	RZE	8	3000	210.0	185.0	35.0
TPS628302KRZER	WQFN-HR	RZE	8	3000	210.0	185.0	35.0
TPS628303ADRLR	SOT-5X3	DRL	8	4000	210.0	185.0	35.0
TPS628303ARZER	WQFN-HR	RZE	8	3000	210.0	185.0	35.0
TPS628303BDRLR	SOT-5X3	DRL	8	4000	210.0	185.0	35.0
TPS628303KRZER	WQFN-HR	RZE	8	3000	210.0	185.0	35.0
TPS628304ADRLR	SOT-5X3	DRL	8	4000	210.0	185.0	35.0
TPS628304ARZER	WQFN-HR	RZE	8	3000	210.0	185.0	35.0
TPS628304KRZER	WQFN-HR	RZE	8	3000	210.0	185.0	35.0

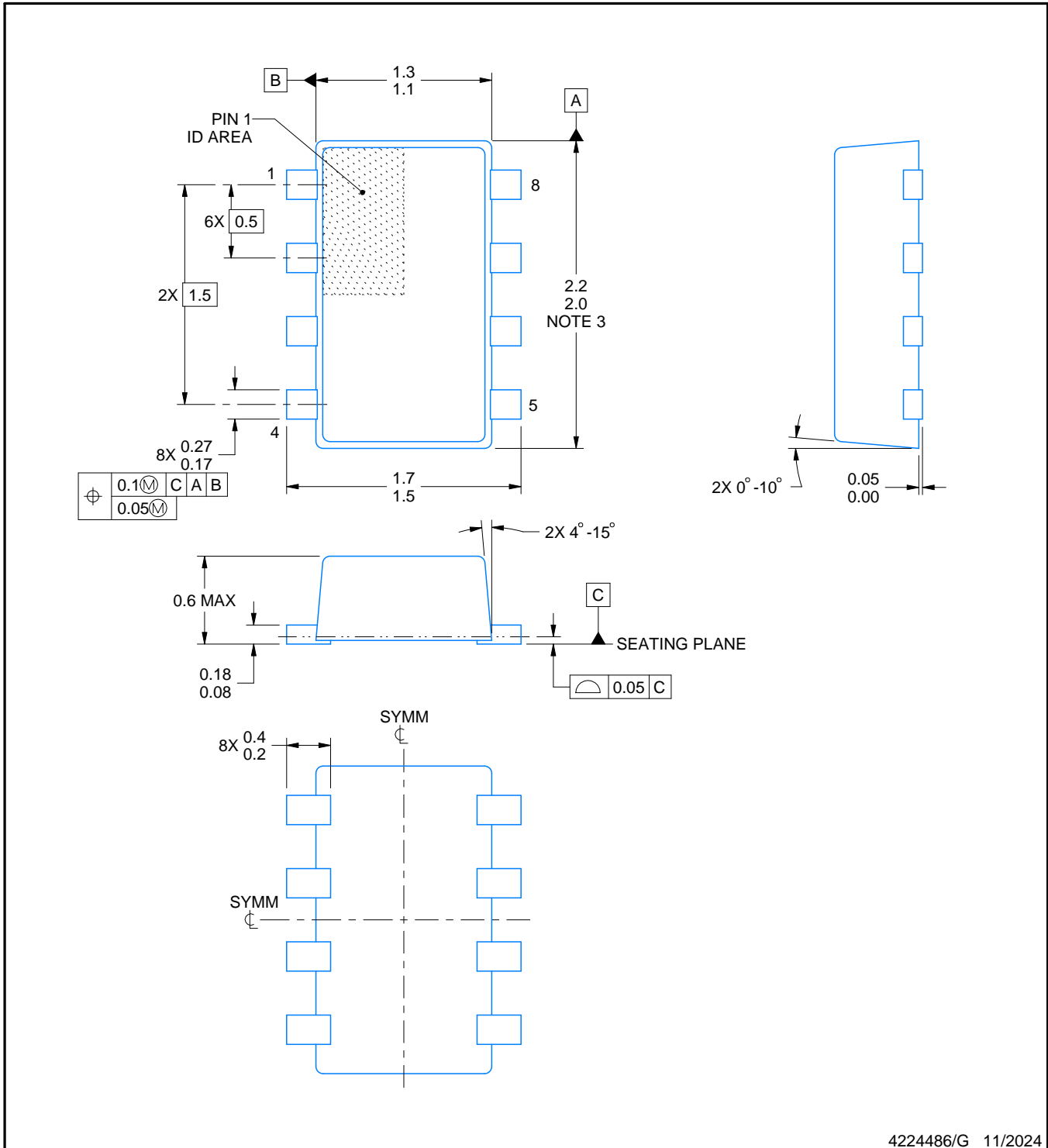

4224486/G 11/2024

NOTES:

1. All linear dimensions are in millimeters. Any dimensions in parenthesis are for reference only. Dimensioning and tolerancing per ASME Y14.5M.
2. This drawing is subject to change without notice.
3. This dimension does not include mold flash, protrusions, or gate burrs. Mold flash, interlead flash, protrusions, or gate burrs shall not exceed 0.15 mm per side.
4. Reference JEDEC Registration MO-293, Variation UDAD

# EXAMPLE BOARD LAYOUT

DRL0008A

SOT-5X3 - 0.6 mm max height

PLASTIC SMALL OUTLINE

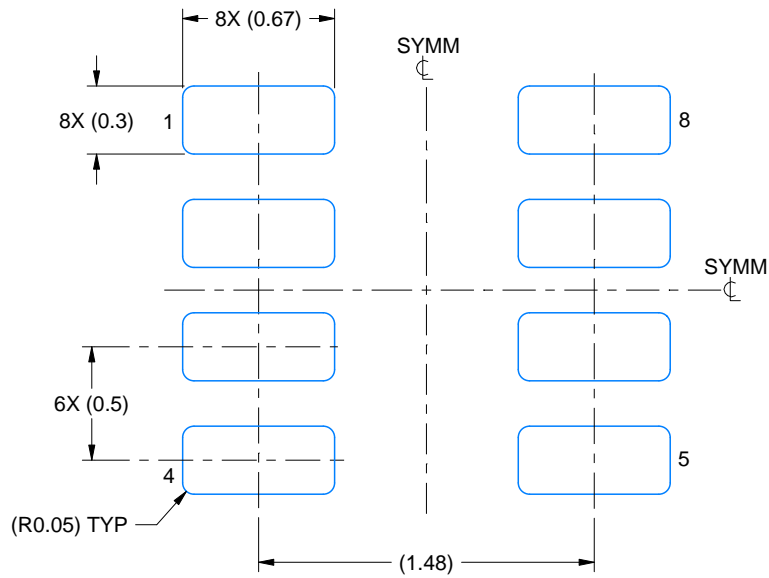

LAND PATTERN EXAMPLE  
EXPOSED METAL SHOWN  
SCALE:30X

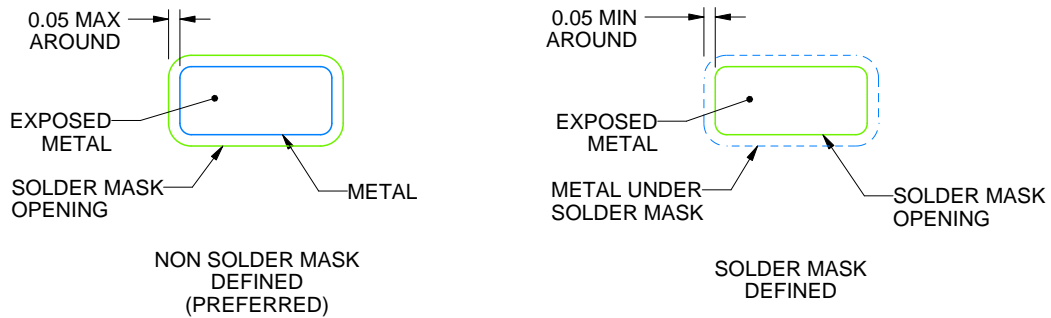

SOLDERMASK DETAILS

4224486/G 11/2024

NOTES: (continued)

5. Publication IPC-7351 may have alternate designs.
6. Solder mask tolerances between and around signal pads can vary based on board fabrication site.
7. Land pattern design aligns to IPC-610, Bottom Termination Component (BTC) solder joint inspection criteria.

# EXAMPLE STENCIL DESIGN

DRL0008A

SOT-5X3 - 0.6 mm max height

PLASTIC SMALL OUTLINE

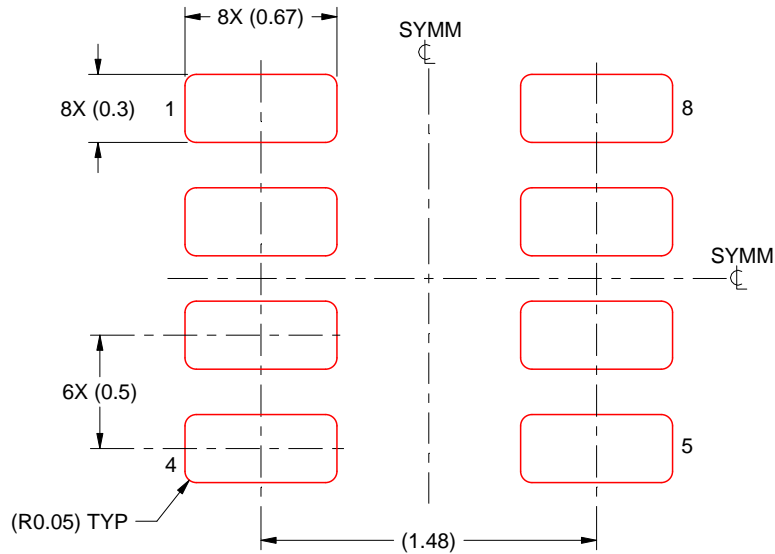

SOLDER PASTE EXAMPLE  
BASED ON 0.1 mm THICK STENCIL  
SCALE:30X

4224486/G 11/2024

NOTES: (continued)

- 8. Laser cutting apertures with trapezoidal walls and rounded corners may offer better paste release. IPC-7525 may have alternate design recommendations.
- 9. Board assembly site may have different recommendations for stencil design.

# RZE0008A

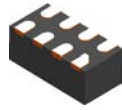

## PACKAGE OUTLINE

### WQFN-HR - 0.8mm max height

QFN (PLASTIC QUAD FLATPACK - NO LEAD)

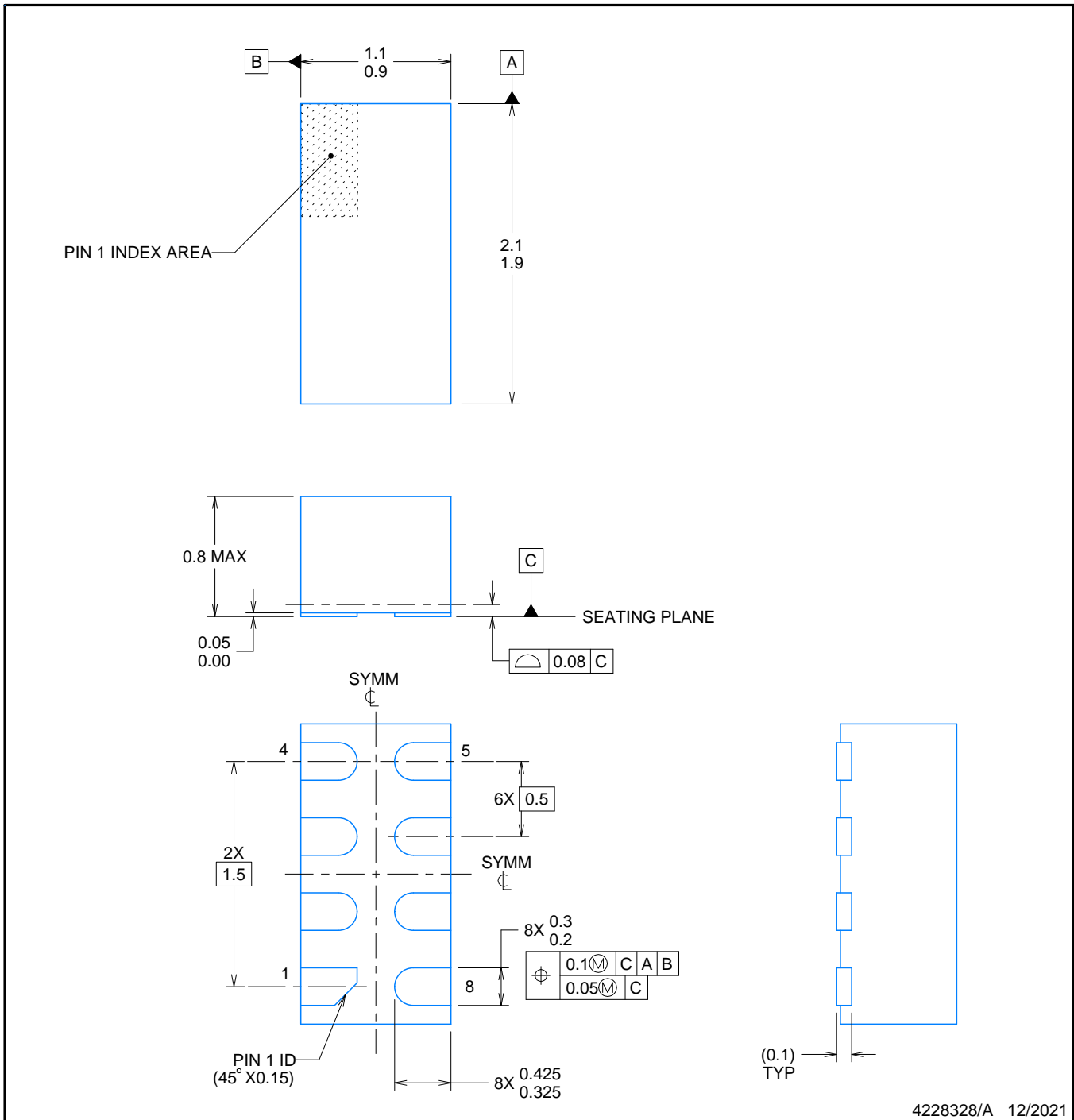

#### NOTES:

1. All linear dimensions are in millimeters. Dimensions in parenthesis are for reference only. Dimensioning and tolerancing per ASME Y14.5M.
2. This drawing is subject to change without notice.

# EXAMPLE BOARD LAYOUT

RZE0008A

WQFN-HR - 0.8mm max height

QFN (PLASTIC QUAD FLATPACK - NO LEAD)

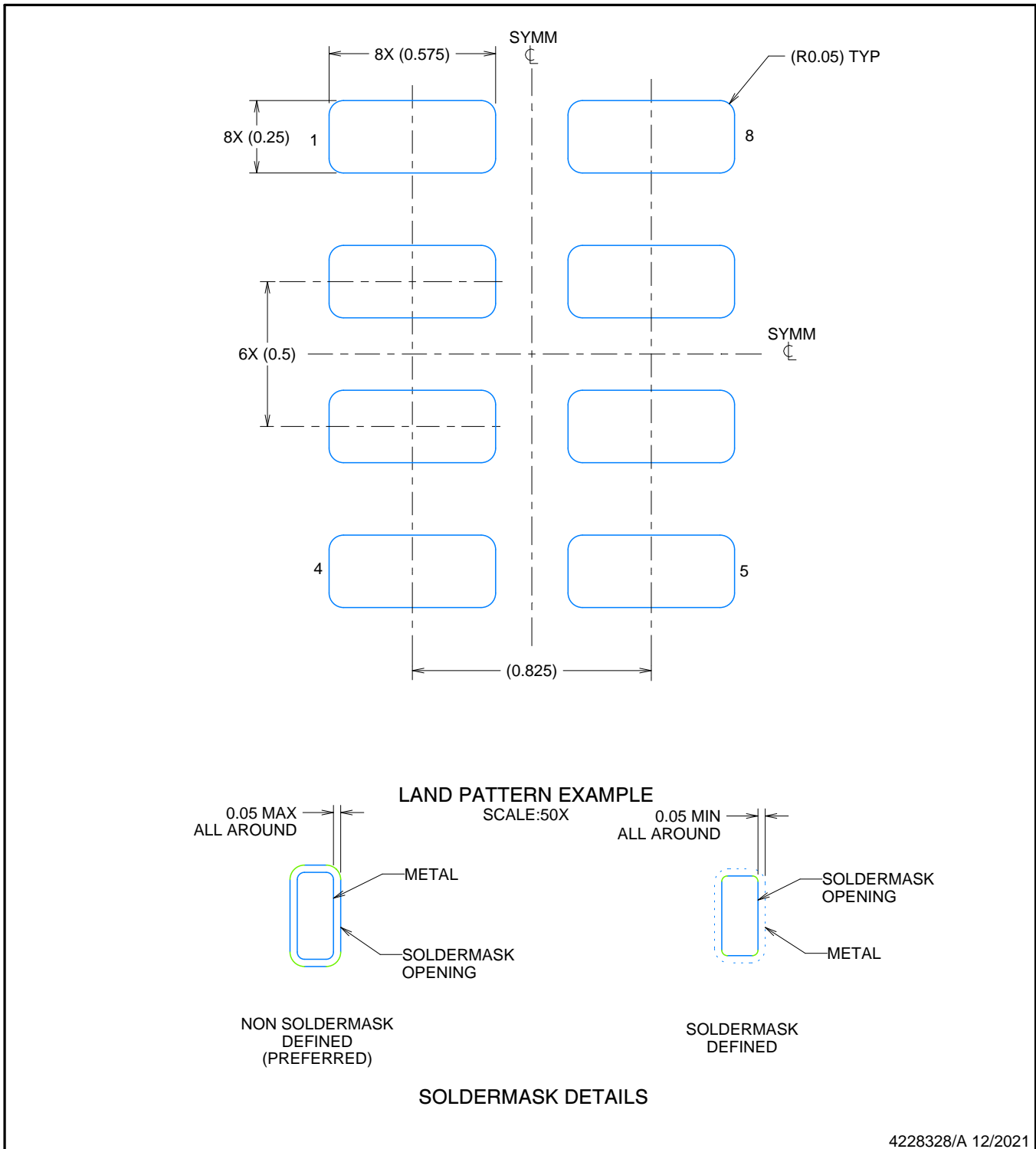

NOTES: (continued)

3. For more information, refer to QFN/SON PCB application note in literature No. SLUA271 ([www.ti.com/lit/slua271](http://www.ti.com/lit/slua271)).

# EXAMPLE STENCIL DESIGN

RZE0008A

WQFN-HR - 0.8mm max height

QFN (PLASTIC QUAD FLATPACK - NO LEAD)

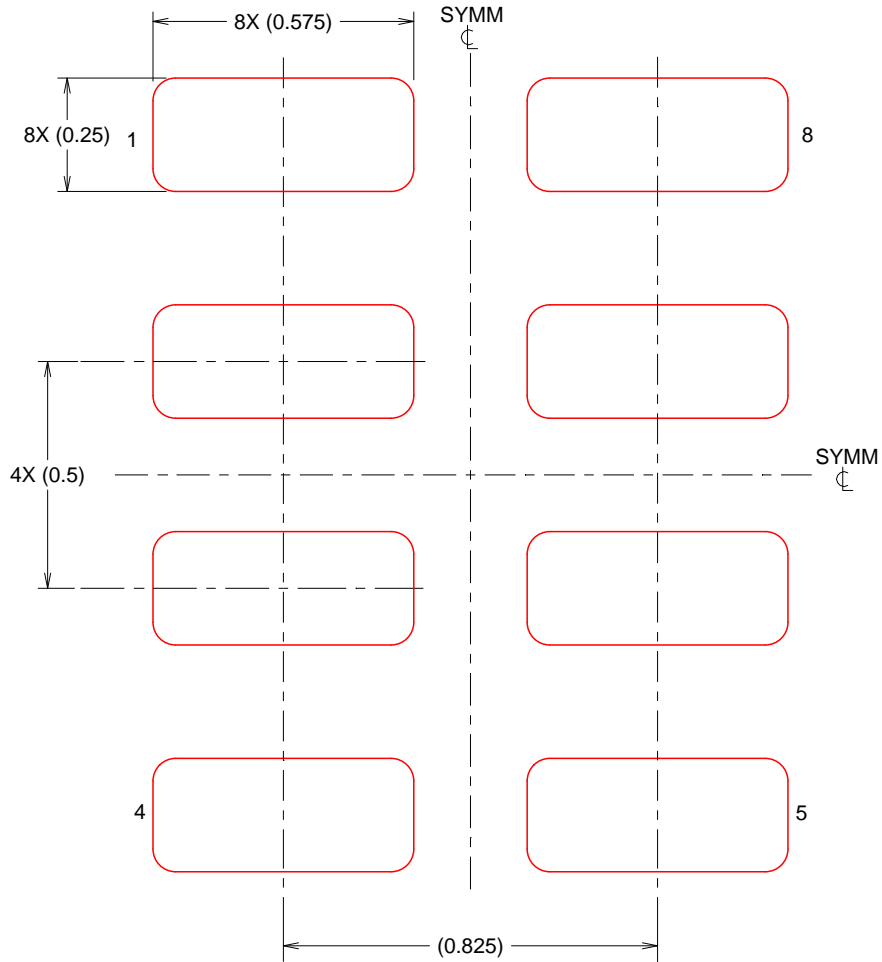

SOLDERPASTE EXAMPLE  
BASED ON 0.1mm THICK STENCIL

SCALE:60X

4228328/A 12/2021

NOTES: (continued)

4. Laser cutting apertures with trapezoidal walls and rounded corners may offer better paste release. IPC-7525 may have alternate design recommendations.



## IMPORTANT NOTICE AND DISCLAIMER

TI PROVIDES TECHNICAL AND RELIABILITY DATA (INCLUDING DATA SHEETS), DESIGN RESOURCES (INCLUDING REFERENCE DESIGNS), APPLICATION OR OTHER DESIGN ADVICE, WEB TOOLS, SAFETY INFORMATION, AND OTHER RESOURCES "AS IS" AND WITH ALL FAULTS, AND DISCLAIMS ALL WARRANTIES, EXPRESS AND IMPLIED, INCLUDING WITHOUT LIMITATION ANY IMPLIED WARRANTIES OF MERCHANTABILITY, FITNESS FOR A PARTICULAR PURPOSE OR NON-INFRINGEMENT OF THIRD PARTY INTELLECTUAL PROPERTY RIGHTS.

These resources are intended for skilled developers designing with TI products. You are solely responsible for (1) selecting the appropriate TI products for your application, (2) designing, validating and testing your application, and (3) ensuring your application meets applicable standards, and any other safety, security, regulatory or other requirements.

These resources are subject to change without notice. TI grants you permission to use these resources only for development of an application that uses the TI products described in the resource. Other reproduction and display of these resources is prohibited. No license is granted to any other TI intellectual property right or to any third party intellectual property right. TI disclaims responsibility for, and you will fully indemnify TI and its representatives against, any claims, damages, costs, losses, and liabilities arising out of your use of these resources.

TI's products are provided subject to [TI's Terms of Sale](#) or other applicable terms available either on [ti.com](https://www.ti.com) or provided in conjunction with such TI products. TI's provision of these resources does not expand or otherwise alter TI's applicable warranties or warranty disclaimers for TI products.

TI objects to and rejects any additional or different terms you may have proposed.

Mailing Address: Texas Instruments, Post Office Box 655303, Dallas, Texas 75265  
Copyright © 2025, Texas Instruments Incorporated