

TPS6213x 3-V to 17-V, 3-A Step-Down Converter In 3-mm × 3-mm QFN Package

1 Features

- DCS-Control™ topology
- Input voltage range: 3 V to 17 V
- Up to 3-A output current
- Adjustable output voltage from 0.9 V to 6 V
- Pin-selectable output voltage (nominal, + 5%)
- Programmable soft start and tracking
- Seamless power save mode transition
- Quiescent current of 17 μ A (typical)
- Selectable operating frequency
- Power-good output
- 100% duty cycle mode
- Short circuit protection
- Overtemperature protection
- Pin-to-pin compatible with the [TPS62140](#) and [TPS62150](#)
- Available in a 3-mm × 3-mm, QFN-16 package
- Use the [TPS82130](#) for faster designs

2 Applications

- Standard 12-V rail supplies
- POL supply from single or multiple Li-ion battery
- [Solid-state drives](#)
- Embedded systems
- LDO replacement
- [Mobile PCs, tablets, modems, cameras](#)
- [Server, microserver](#)
- [Data terminal, point of sales \(ePOS\)](#)

3 Description

The TPS6213x family are easy-to-use synchronous step down DC-DC converters optimized for applications with high power density. A high switching frequency of typically 2.5 MHz allows the use of small inductors and provides fast transient response as well as high output voltage accuracy by use of the DCS-Control topology.

With their wide operating input voltage range of 3 V to 17 V, the devices are ideally suited for systems powered from either a Li-Ion or other batteries as well as from 12-V intermediate power rails. They support up to 3-A continuous output current at output voltages between 0.9 V and 6 V (with 100% duty cycle mode). The output voltage start-up ramp is controlled by the soft-start pin, which allows operation as either a stand-alone power supply or in tracking configurations. Power sequencing is also possible by configuring the Enable and open-drain Power Good pins.

In power save mode, the devices draw quiescent current of approximately 17 μ A from V_{IN} . Power save mode, entered automatically and seamlessly if the load is small, maintains high efficiency over the entire load range. In shutdown mode, the device is turned off and shutdown current consumption is less than 2 μ A.

The device, available in adjustable and fixed output voltage versions, is packaged in a 16-pin VQFN package measuring 3 mm × 3 mm (RGT).

Device Information

PART NUMBER	PACKAGE ⁽¹⁾	BODY SIZE (NOM)
TPS6213x	VQFN (16)	3.00 mm × 3.00 mm

- (1) For all available packages, see the orderable addendum at the end of the data sheet.

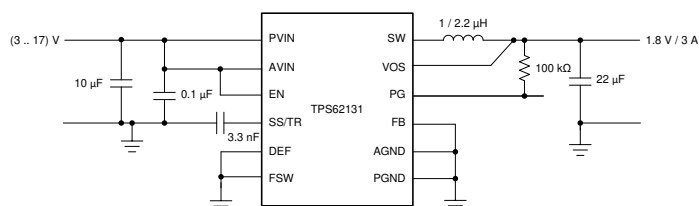

Typical Application Schematic

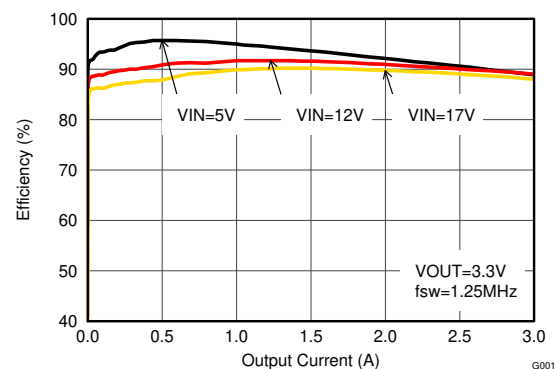

Efficiency vs Output Current



Table of Contents

1 Features	1	9.1 Application Information.....	13
2 Applications	1	9.2 Typical Application.....	13
3 Description	1	9.3 System Examples.....	25
4 Revision History	2	10 Power Supply Recommendations	28
5 Device Comparison Table	3	11 Layout	28
6 Pin Configuration and Functions	3	11.1 Layout Guidelines.....	28
7 Specifications	4	11.2 Layout Example.....	29
7.1 Absolute Maximum Ratings ⁽¹⁾	4	11.3 Thermal Information.....	29
7.2 ESD Ratings.....	4	12 Device and Documentation Support	30
7.3 Recommended Operating Conditions.....	4	12.1 Device Support.....	30
7.4 Thermal Information.....	4	12.2 Documentation Support.....	30
7.5 Electrical Characteristics.....	5	12.3 Receiving Notification of Documentation Updates.....	30
7.6 Typical Characteristics.....	6	12.4 Support Resources.....	30
8 Detailed Description	7	12.5 Trademarks.....	30
8.1 Overview.....	7	12.6 Electrostatic Discharge Caution.....	30
8.2 Functional Block Diagram.....	8	12.7 Glossary.....	30
8.3 Feature Description.....	9	13 Mechanical, Packaging, and Orderable Information	31
8.4 Device Functional Modes.....	11		
9 Application and Implementation	13		

4 Revision History

NOTE: Page numbers for previous revisions may differ from page numbers in the current version.

Changes from Revision E (August 2016) to Revision F (November 2021)	Page
• Added link to the TPS82130 product page	1
• Updated the numbering format for tables, figures, and cross-references throughout the document.	1
• Edited data sheet for grammar.....	1

Changes from Revision D (June 2016) to Revision E (August 2016)	Page
• Changed the T_J MAX value From: 125°C To: 150°C in the <i>Absolute Maximum Ratings</i>	4
• Changed ($T_J = -40^\circ\text{C}$ to 85°C) To: ($T_J = -40^\circ\text{C}$ to 125°C) in the <i>Section 7.5</i> conditions.....	5
• Added a test condition for I_Q at $T_A = -40^\circ\text{C}$ to $+85^\circ\text{C}$ in the <i>Section 7.5</i>	5
• Added Table 8-1 and Table 8-2	10

5 Device Comparison Table

PART NUMBER	OUTPUT VOLTAGE	POWER GOOD LOGIC LEVEL (EN = LOW)
TPS62130	adjustable	High Impedance
TPS62130A	adjustable	Low
TPS62131	1.8 V	High Impedance
TPS62132	3.3 V	High Impedance
TPS62133	5.0 V	High Impedance

6 Pin Configuration and Functions

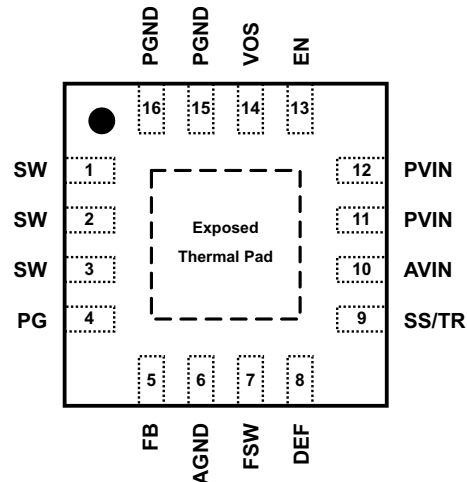

Figure 6-1. 16-Pin VQFN With Exposed Thermal Pad (RGT) Top View

Table 6-1. Pin Functions

PIN ⁽¹⁾		I/O	DESCRIPTION
NO.	NAME		
1,2,3	SW	O	Switch node, which is connected to the internal MOSFET switches. Connect an inductor between SW and the output capacitor.
4	PG	O	Output power good (High = V_{OUT} ready, Low = V_{OUT} below nominal regulation); open drain (requires pullup resistor)
5	FB	I	Voltage feedback of adjustable version. Connect a resistive voltage divider to this pin. It is recommended to connect FB to AGND on fixed output voltage versions for improved thermal performance.
6	AGND		Analog Ground. Must be connected directly to the Exposed Thermal Pad and common ground plane.
7	FSW	I	Switching Frequency Select (Low \approx 2.5 MHz, High \approx 1.25 MHz ⁽²⁾ for typical operation) ⁽³⁾
8	DEF	I	Output voltage scaling (Low = nominal, High = nominal + 5%) ⁽³⁾
9	SS/TR	I	Soft-Start/Tracking Pin. An external capacitor connected to this pin sets the internal voltage reference rise time. It can be used for tracking and sequencing.
10	AVIN	I	Supply voltage for control circuitry. Connect to the same source as PVIN.
11,12	PVIN	I	Supply voltage for power stage. Connect to the same source as AVIN.
13	EN	I	Enable input (High = enabled, Low = disabled) ⁽³⁾
14	VOS	I	Output voltage sense pin and connection for the control loop circuitry
15,16	PGND		Power Ground. Must be connected directly to the Exposed Thermal Pad and common ground plane.
	Exposed Thermal Pad		Must be connected to AGND (pin 6), PGND (pin 15,16), and common ground plane. See the Layout Example . Must be soldered to achieve appropriate power dissipation and mechanical reliability.

- (1) For more information about connecting pins, see the [Detailed Description](#) and [Application and Implementation](#) sections.
(2) Connect FSW to V_{OUT} or PG in this case.
(3) An internal pulldown resistor keeps logic level low if pin is floating.

7 Specifications

7.1 Absolute Maximum Ratings⁽¹⁾

over operating junction temperature range (unless otherwise noted)

		MIN	MAX	UNIT
Pin voltage range ⁽²⁾	AVIN, PVIN	-0.3	20	V
	EN, SS/TR	-0.3	V _{IN} +0.3	
	SW	-0.3	V _{IN} +0.3	V
	DEF, FSW, FB, PG, VOS	-0.3	7	V
Power Good sink current	PG		10	mA
Operating junction temperature, T _J		-40	150	°C
Storage temperature, T _{stg}		-65	150	°C

- (1) Stresses beyond those listed under *absolute maximum ratings* may cause permanent damage to the device. These are stress ratings only, and functional operation of the device at these or any other conditions beyond those indicated under *recommended operating conditions* is not implied. Exposure to absolute-maximum-rated conditions for extended periods may affect device reliability.
- (2) All voltages are with respect to network ground terminal.

7.2 ESD Ratings

		VALUE	UNIT
V _(ESD) Electrostatic discharge ⁽¹⁾	Human-body model (HBM), per ANSI/ESDA/JEDEC JS-001 ⁽²⁾	±2000	V
	Charged-device model (CDM), per JEDEC specification JESD22-C101 ⁽³⁾	±500	

- (1) ESD testing is performed according to the respective JESD22 JEDEC standard.
- (2) JEDEC document JEP155 states that 500-V HBM allows safe manufacturing with a standard ESD control process.
- (3) JEDEC document JEP157 states that 250-V CDM allows safe manufacturing with a standard ESD control process.

7.3 Recommended Operating Conditions

over operating junction temperature range (unless otherwise noted)

	MIN	MAX	UNIT
Supply Voltage, V _{IN} (at AVIN and PVIN)	3	17	V
Operating junction temperature, T _J	-40	125	°C

7.4 Thermal Information

THERMAL METRIC ⁽¹⁾		TPS6213X	UNITS
		RGT 16 PINS	
R _{θJA}	Junction-to-ambient thermal resistance	45	°C/W
R _{θJctop}	Junction-to-case(top) thermal resistance	53.6	
R _{θJB}	Junction-to-board thermal resistance	17.4	
ψ _{JT}	Junction-to-top characterization parameter	1.1	
ψ _{JB}	Junction-to-board characterization parameter	17.4	
R _{θJcbot}	Junction-to-case(bottom) thermal resistance	4.5	

- (1) For more information about traditional and new thermal metrics, see the [Semiconductor and IC Package Thermal Metrics](#) application report.

7.5 Electrical Characteristics

over operating junction temperature ($T_J = -40^{\circ}\text{C}$ to 125°C), typical values at $V_{IN} = 12\text{ V}$ and $T_A = 25^{\circ}\text{C}$ (unless otherwise noted)

PARAMETER		TEST CONDITIONS	MIN	TYP	MAX	UNIT
SUPPLY						
V_{IN}	Input voltage range ⁽¹⁾		3		17	V
I_Q	Operating quiescent current	EN=High, $I_{OUT} = 0\text{ mA}$, device not switching		17	30	μA
		$T_A = -40^{\circ}\text{C}$ to $+85^{\circ}\text{C}$		17	25	
I_{SD}	Shutdown current ⁽²⁾	EN=Low		1.5	25	μA
		$T_A = -40^{\circ}\text{C}$ to $+85^{\circ}\text{C}$		1.5	4	
V_{UVLO}	Undervoltage lockout threshold	Falling Input Voltage (PWM mode operation)	2.6	2.7	2.8	V
		Hysteresis		200		mV
T_{SD}	Thermal shutdown temperature			160		$^{\circ}\text{C}$
	Thermal shutdown hysteresis			20		
CONTROL (EN, DEF, FSW, SS/TR, PG)						
V_H	High level input threshold voltage (EN, DEF, FSW)		0.9	0.65		V
V_L	Low level input threshold voltage (EN, DEF, FSW)			0.45	0.3	V
I_{LKG}	Input leakage current (EN, DEF, FSW)	EN= V_{IN} or GND; DEF, FSW= V_{OUT} or GND		0.01	1	μA
V_{TH_PG}	Power good threshold voltage	Rising (% V_{OUT})	92%	95%	98%	
		Falling (% V_{OUT})	87%	90%	94%	
V_{OL_PG}	Power good output low	$I_{PG} = -2\text{ mA}$		0.07	0.3	V
I_{LKG_PG}	Input leakage current (PG)	$V_{PG} = 1.8\text{ V}$		1	400	nA
$I_{SS/TR}$	SS/TR pin source current		2.3	2.5	2.7	μA
POWER SWITCH						
$R_{DS(ON)}$	High-side MOSFET ON-resistance	$V_{IN} \geq 6\text{ V}$		90	170	$\text{m}\Omega$
		$V_{IN} = 3\text{ V}$		120		
	Low-side MOSFET ON-resistance	$V_{IN} \geq 6\text{ V}$		40	70	$\text{m}\Omega$
		$V_{IN} = 3\text{ V}$		50		
I_{LIMF}	High-side MOSFET forward current limit ⁽³⁾	$V_{IN} = 12\text{ V}$, $T_A = 25^{\circ}\text{C}$	3.6	4.2	4.9	A
OUTPUT						
I_{LKG_FB}	Input leakage current (FB)	TPS62130, $V_{FB} = 0.8\text{ V}$		1	100	nA
V_{OUT}	Output voltage range (TPS62130)	$V_{IN} \geq V_{OUT}$	0.9		6.0	V
	DEF (Output voltage programming)	DEF=0 (GND)		V_{OUT}		
		DEF=1 (V_{OUT})		$V_{OUT} + 5\%$		
	Initial output voltage accuracy ⁽⁴⁾	PWM mode operation, $V_{IN} \geq V_{OUT} + 1\text{ V}$	785.6	800	814.4	mV
		PWM mode operation, $V_{IN} \geq V_{OUT} + 1\text{ V}$, $T_A = -10^{\circ}\text{C}$ to 85°C	788.0	800	812.8	
		Power Save Mode operation, $C_{OUT} = 22\mu\text{F}$	781.6	800	822.4	
	Tracking Feedback Voltage (TPS62130)	$V_{SS/TR} = 350\text{ mV}$	212.6	225	237.4	mV
Load regulation ⁽⁵⁾	$V_{IN} = 12\text{ V}$, $V_{OUT} = 3.3\text{ V}$, PWM mode operation		0.05		%/A	
Line regulation ⁽⁵⁾	$3\text{ V} \leq V_{IN} \leq 17\text{ V}$, $V_{OUT} = 3.3\text{ V}$, $I_{OUT} = 1\text{ A}$, PWM mode operation		0.02		%/V	

(1) The device is still functional down to Under Voltage Lockout (see parameter V_{UVLO}).

(2) Current into AVIN+PVIN pin.

(3) This is the static current limit. It can be temporarily higher in applications due to internal propagation delay (see Section 8.4.4 section).

(4) This is the accuracy provided at the FB pin for the adjustable V_{OUT} version (line and load regulation effects are not included). For the fixed output voltage versions the (internal) resistive divider is included.

(5) Line and load regulation depend on external component selection and layout (see Figure 9-16 and Figure 9-17).

7.6 Typical Characteristics

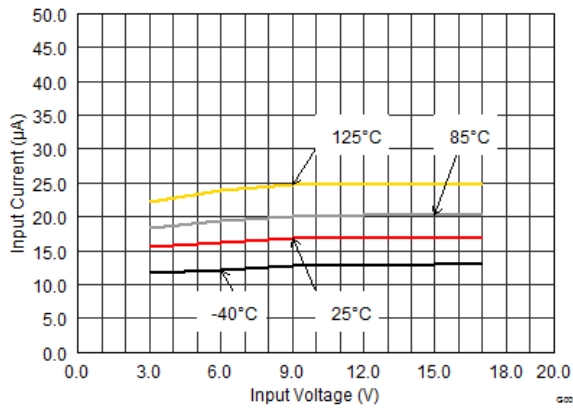

Figure 7-1. Quiescent Current

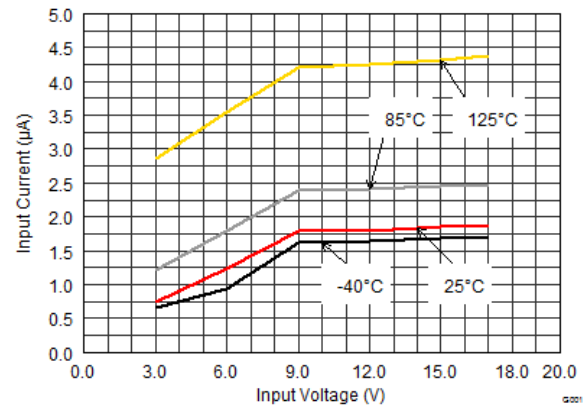

Figure 7-2. Shutdown Current

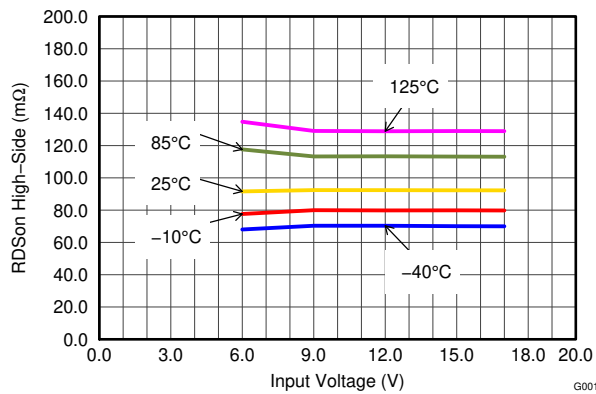

Figure 7-3. High-Side Switch Resistance

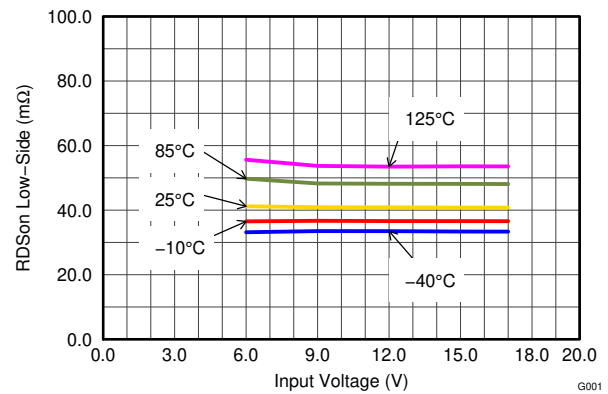

Figure 7-4. Low-Side Switch Resistance

8 Detailed Description

8.1 Overview

The TPS6213x synchronous switched mode power converters are based on DCS-Control (**D**irect **C**ontrol with **S**eamless **T**ransition into power save mode), an advanced regulation topology that combines the advantages of hysteretic, voltage mode, and current mode control including an AC loop directly associated to the output voltage. This control loop takes information about output voltage changes and feeds it directly to a fast comparator stage. It sets the switching frequency, which is constant for steady state operating conditions, and provides immediate response to dynamic load changes. To get accurate DC load regulation, a voltage feedback loop is used. The internally compensated regulation network achieves fast and stable operation with small external components and low-ESR capacitors.

The DCS-Control topology supports PWM (Pulse Width Modulation) mode for medium and heavy load conditions and a power save mode at light loads. During PWM, the device operates at its nominal switching frequency in continuous conduction mode. This frequency is typically approximately 2.5 MHz or 1.25 MHz with a controlled frequency variation depending on the input voltage. If the load current decreases, the converter enters power save mode to sustain high efficiency down to very light loads. In power save mode, the switching frequency decreases linearly with the load current. Since DCS-Control supports both operation modes within one single building block, the transition from PWM to power save mode is seamless without effects on the output voltage.

Fixed output voltage versions provide the smallest solution size and lowest current consumption, requiring only four external components. An internal current limit supports nominal output currents of up to 3 A.

The TPS6213x family offers both excellent DC voltage and superior load transient regulation, combined with very low output voltage ripple, minimizing interference with RF circuits.

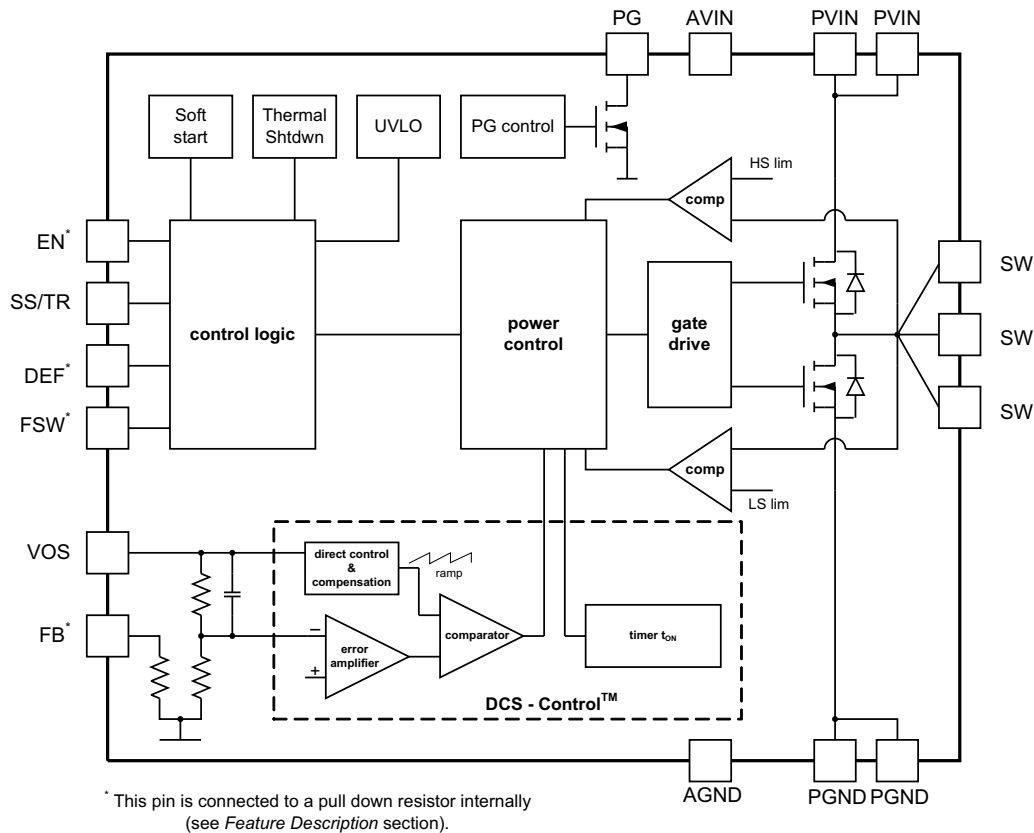

Figure 8-2. TPS62131/2/3 (Fixed Output Voltage)

8.3 Feature Description

8.3.1 Enable / Shutdown (EN)

When Enable (EN) is set High, the device starts operation. Shutdown is forced if EN is pulled Low with a shutdown current of typically 1.5 μ A. During shutdown, the internal power MOSFETs as well as the entire control circuitry are turned off. The internal resistive divider pulls down the output voltage smoothly. The EN signal must be set externally to High or Low. An internal pulldown resistor of approximately 400 k Ω is connected and keeps EN logic low, if Low is set initially and then the pin gets floating. It is disconnected if the pin is set High.

Connecting the EN pin to an appropriate output signal of another power rail provides sequencing of multiple power rails.

8.3.2 Soft Start / Tracking (SS/TR)

The internal soft start circuitry controls the output voltage slope during start-up. This avoids excessive inrush current and ensures a controlled output voltage rise time. It also prevents unwanted voltage drops from high-impedance power sources or batteries. When EN is set to start device operation, the device starts switching after a delay of approximately 50 μ s and V_{OUT} rises with a slope controlled by an external capacitor connected to the SS/TR pin. See Figure 9-34 and Figure 9-35 for typical start-up operation.

Using a very small capacitor (or leaving SS/TR pin un-connected) provides fastest start-up behavior. There is no theoretical limit for the longest start-up time. The TPS6213x can start into a pre-biased output. During monotonic pre-biased start-up, both the power MOSFETs are not allowed to turn on until the internal ramp of the device sets an output voltage above the pre-bias voltage. As long as the output is below approximately 0.5 V, a reduced current limit of typically 1.6 A is set internally. If the device is set to shutdown (EN = GND), undervoltage lockout, or thermal shutdown, an internal resistor pulls the SS/TR pin down to ensure a proper low level. Returning from those states causes a new start-up sequence as set by the SS/TR connection.

A voltage supplied to SS/TR can be used for tracking a primary voltage. The output voltage will follow this voltage in both directions up and down (see [Section 9](#)).

8.3.3 Power Good (PG)

The TPS6213x has a built-in power good (PG) function to indicate whether the output voltage has reached its appropriate level or not. The PG signal can be used for start-up sequencing of multiple rails. The PG pin is an open-drain output that requires a pullup resistor (to any voltage below 7 V). It can sink 2 mA of current and maintain its specified logic low level. With TPS62130, it is high impedance when the device is turned off due to EN, UVLO, or thermal shutdown. The TPS62130A features PG = Low in this case and can be used to actively discharge V_{OUT} (see [Figure 9-41](#)). V_{IN} must remain present for the PG pin to stay Low. See the [TPS62130A Differences to TPS62130 Application Report](#) for application details. If not used, the PG pin should be connected to GND but may be left floating.

Table 8-1. Power Good Pin Logic Table (TPS62130)

DEVICE STATE		PG LOGIC STATUS	
		HIGH IMPEDANCE	LOW
Enable (EN = High)	$V_{FB} \geq V_{TH_PG}$	√	
	$V_{FB} \leq V_{TH_PG}$		√
Shutdown (EN = Low)		√	
UVLO	$0.7\text{ V} < V_{IN} < V_{UVLO}$	√	
Thermal Shutdown	$T_J > T_{SD}$	√	
Power Supply Removal	$V_{IN} < 0.7\text{ V}$	√	

Table 8-2. Power Good Pin Logic Table (TPS62130A)

DEVICE STATE		PG LOGIC STATUS	
		HIGH IMPEDANCE	LOW
Enable (EN = High)	$V_{FB} \geq V_{TH_PG}$	√	
	$V_{FB} \leq V_{TH_PG}$		√
Shutdown (EN = Low)			√
UVLO	$0.7\text{ V} < V_{IN} < V_{UVLO}$		√
Thermal Shutdown	$T_J > T_{SD}$		√
Power Supply Removal	$V_{IN} < 0.7\text{ V}$	√	

8.3.4 Pin-Selectable Output Voltage (DEF)

The output voltage of the TPS6213x devices can be increased by 5% above the nominal voltage by setting the DEF pin to High.¹ When DEF is Low, the device regulates to the nominal output voltage. Increasing the nominal voltage allows the user to adapt the power supply voltage to the variations of the application hardware. More detailed information on voltage margining using TPS6213x can be found in [Voltage Margining Using the TPS62130 Application Report](#). A pulldown resistor of approximately 400 kΩ is internally connected to the pin to ensure a proper logic level if the pin is high impedance or floating after initially set to Low. The resistor is disconnected if the pin is set High.

8.3.5 Frequency Selection (FSW)

To get high power density with a very small solution size, a high switching frequency allows the use of small external components for the output filter. However, switching losses increase with the switching frequency. If efficiency is the key parameter, more than solution size, the switching frequency can be set to half (1.25 MHz

¹ Maximum allowed voltage is 7 V. Therefore, it is recommended to connect it to V_{OUT} or PG, not V_{IN} .

typical) by pulling FSW to High. It is mandatory to start with FSW = Low to limit inrush current, which can be done by connecting the pin to V_{OUT} or PG. Running with lower frequency, a higher efficiency, but also a higher output voltage ripple, is achieved. Pull FSW to Low for high frequency operation (2.5 MHz typical). To get low ripple and full output current at the lower switching frequency, it is recommended to use an inductor of at least 2.2 µH. The switching frequency can be changed during operation, if needed. A pulldown resistor of about 400 kΩ is internally connected to the pin, acting the same way as at the DEF pin (see above).

8.3.6 Undervoltage Lockout (UVLO)

If the input voltage drops, the undervoltage lockout prevents misoperation of the device by switching off both the power FETs. The undervoltage lockout threshold is set typically to 2.7 V. The device is fully operational for voltages above the UVLO threshold and turns off if the input voltage trips the threshold. The converter starts operation again once the input voltage exceeds the threshold by a hysteresis of typically 200 mV.

8.3.7 Thermal Shutdown

The junction temperature (T_J) of the device is monitored by an internal temperature sensor. If T_J exceeds 160°C (typical), the device goes into thermal shutdown. Both the high-side and low-side power FETs are turned off and PG goes high impedance. When T_J decreases below the hysteresis amount, the converter resumes normal operation, beginning with soft start. To avoid unstable conditions, a hysteresis of typically 20°C is implemented on the thermal shutdown temperature.

8.4 Device Functional Modes

8.4.1 Pulse Width Modulation (PWM) Operation

The TPS6213x operates with pulse width modulation in continuous conduction mode (CCM) with a nominal switching frequency of 2.5 MHz or 1.25 MHz, selectable with the FSW pin. The frequency variation in PWM is controlled and depends on V_{IN}, V_{OUT}, and the inductance. The device operates in PWM mode as long the output current is higher than half the ripple current of the inductor. To maintain high efficiency at light loads, the device enters power save mode at the boundary to discontinuous conduction mode (DCM). This happens if the output current becomes smaller than half the ripple current of the inductor.

8.4.2 Power Save Mode Operation

The TPS6213x enters its built-in power save mode seamlessly if the load current decreases. This secures a high efficiency in light-load operation. The device remains in power save mode as long as the inductor current is discontinuous.

In power save mode, the switching frequency decreases linearly with the load current maintaining high efficiency. The transition into and out of power save mode happens within the entire regulation scheme and is seamless in both directions.

The TPS6213x includes a fixed on-time circuitry. An estimate for this on time in steady-state operation with FSW = Low is:

$$t_{ON} = \frac{V_{OUT}}{V_{IN}} \cdot 400ns \quad (1)$$

For very small output voltages, an absolute minimum on time of approximately 80 ns is kept to limit switching losses. The operating frequency is thereby reduced from its nominal value, which keeps efficiency high. Also, the off time can reach its minimum value at high duty cycles. The output voltage remains regulated in such case. Using t_{ON}, the typical peak inductor current in power save mode can be approximated by:

$$I_{LPSM(peak)} = \frac{(V_{IN} - V_{OUT})}{L} \cdot t_{ON} \quad (2)$$

When V_{IN} decreases to typically 15% above V_{OUT}, the TPS6213x does not enter power save mode, regardless of the load current. The device maintains output regulation in PWM mode.

8.4.3 100% Duty-Cycle Operation

The duty cycle of the buck converter is given by $D = V_{OUT} / V_{IN}$ and increases as the input voltage comes close to the output voltage. In this case, the device starts 100% duty cycle operation turning on the high-side switch 100% of the time. The high-side switch stays turned on as long as the output voltage is below the internal set point. This allows the conversion of small input to output voltage differences (for example, for the longest operation time of battery-powered applications). In 100% duty cycle mode, the low-side FET is switched off.

The minimum input voltage to maintain output voltage regulation, depending on the load current and the output voltage level, can be calculated as:

$$V_{IN(min)} = V_{OUT(min)} + I_{OUT} (R_{DS(on)} + R_L) \quad (3)$$

where

- I_{OUT} is the output current.
- $R_{DS(on)}$ is the $R_{DS(on)}$ of the high-side FET.
- R_L is the DC resistance of the inductor used.

8.4.4 Current Limit And Short Circuit Protection

The TPS6213x devices have protection against heavy load and short circuit events. If a short circuit is detected (V_{OUT} drops below 0.5 V), the current limit is reduced to 1.6 A typically. If the output voltage rises above 0.5 V, the device runs in normal operation again. At heavy loads, the current limit determines the maximum output current. If the current limit is reached, the high-side FET is turned off. Avoiding shoot-through current, then the low-side FET switches on to allow the inductor current to decrease. The low-side current limit is typically 3.5 A. The high-side FET turns on again only if the current in the low-side FET has decreased below the low-side current limit threshold.

The output current of the device is limited by the current limit. Due to internal propagation delay, the actual current can exceed the static current limit during that time. The dynamic current limit can be calculated as follows:

$$I_{peak(typ)} = I_{LIMF} + \frac{V_L}{L} \cdot t_{PD} \quad (4)$$

where

- I_{LIMF} is the static current limit, specified in the [Electrical Characteristics](#).
- L is the inductor value.
- V_L is the voltage across the inductor ($V_{IN} - V_{OUT}$).
- t_{PD} is the internal propagation delay.

The current limit can exceed static values, especially if the input voltage is high and very small inductances are used. The dynamic high-side switch peak current can be calculated as follows:

$$I_{peak(typ)} = I_{LIMF} + \frac{(V_{IN} - V_{OUT})}{L} \cdot 30ns \quad (5)$$

9 Application and Implementation

Note

Information in the following applications sections is not part of the TI component specification, and TI does not warrant its accuracy or completeness. TI's customers are responsible for determining suitability of components for their purposes, as well as validating and testing their design implementation to confirm system functionality.

9.1 Application Information

The TPS6213x is a switched mode step-down converter that is able to convert a 3V- to 17-V input voltage into a 0.9-V to 6-V output voltage, providing up to 3 A. The device needs a minimum amount of external components. Apart from the LC output filter and the input capacitors, only the TPS62130 (TPS62130A) with adjustable output voltage needs an additional resistive divider to set the output voltage level.

9.2 Typical Application

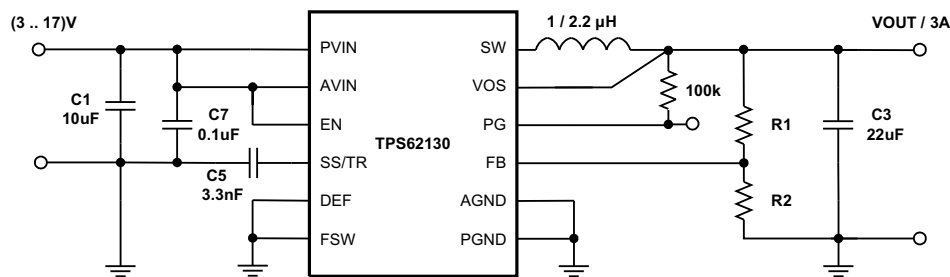

Figure 9-1. 3-A Step-Down Converter for Point-Of-Load Power Supply Using the TPS62130

9.2.1 Design Requirements

The following design guideline provides a component selection to operate the device within the recommended operating conditions. Using the FSW pin, the design can be optimized for highest efficiency or smallest solution size and lowest output voltage ripple. For highest efficiency set FSW = High and the device operates at the lower switching frequency. For the smallest solution size and lowest output voltage ripple, set FSW = Low and the device operates with higher switching frequency. The typical values for all measurements are $V_{IN} = 12\text{ V}$, $V_{OUT} = 3.3\text{ V}$ and $T = 25^\circ\text{C}$, using the external components of [Table 9-1](#).

The component selection used for measurements is given as follows:

Table 9-1. List Of Components

REFERENCE	DESCRIPTION	MANUFACTURER ⁽¹⁾
IC	17-V, 3-A Step-Down Converter, QFN	TPS62130RGT, Texas Instruments
L1	2.2 μH , 0.165 inch x 0.165 inch	XFL4020-222MEB, Coilcraft
C1	10 μF , 25 V, Ceramic, 1210	Standard
C3	22 μF , 6.3 V, Ceramic, 0805	Standard
C5	3300 pF, 25 V, Ceramic, 0603	Standard
C7	0.1 μF , 25 V, Ceramic, 0603	Standard
R1	depending on V_{OUT}	
R2	depending on V_{OUT}	
R3	100 k Ω , Chip, 0603, 1/16W, 1%	Standard

(1) See the [Third-Party Products Disclaimer](#).

9.2.2 Detailed Design Procedure

9.2.2.1 Programming The Output Voltage

While the output voltage of the TPS62130 (TPS62130A) is adjustable, the TPS62131, TPS62132, and TPS62133 are programmed to fixed output voltages. For fixed output voltage versions, the FB pin is pulled down internally and can be left floating. It is recommended to connect to AGND to improve thermal resistance. The adjustable version can be programmed for output voltages from 0.9 V to 6 V by using a resistive divider from V_{OUT} to AGND. The voltage at the FB pin is regulated to 800 mV. The value of the output voltage is set by the selection of the resistive divider from Equation 6. It is recommended to choose resistor values that allow a current of at least 2 μA, meaning the value of R₂ should not exceed 400 kΩ. Lower resistor values are recommended for the highest accuracy and most robust design. For applications requiring lowest current consumption, the use of fixed output voltage versions is recommended.

$$R_1 = R_2 \left(\frac{V_{OUT}}{0.8V} - 1 \right) \quad (6)$$

In case the FB pin gets opened, the device clamps the output voltage at the VOS pin internally to approximately 7.4 V.

9.2.2.2 External Component Selection

The external components have to fulfill the needs of the application, but also the stability criteria of the devices control loop. The TPS6213x is optimized to work within a range of external components. The inductance of the LC output filter and capacitance have to be considered together, creating a double pole, responsible for the corner frequency of the converter (see Section 9.2.2.4). Table 9-2 can be used to simplify the output filter component selection. Checked cells represent combinations that are proven for stability by simulation and lab test. Further combinations should be checked for each individual application. See [Optimizing the TPS62130/40/50/60 Output Filter Application Report](#) for details.

Table 9-2. Recommended LC Output Filter Combinations

	4.7 μF	10 μF	22 μF	47 μF	100 μF	200 μF	400 μF
0.47 μH ⁽¹⁾							
1 μH ⁽¹⁾			√	√	√	√	
2.2 μH ⁽¹⁾		√	√ ⁽²⁾	√	√	√	
3.3 μH ⁽¹⁾		√	√	√	√		
4.7 μH ⁽¹⁾							

(1) The values in the table are nominal values. The effective capacitance was considered to vary by +20% and -50%.

(2) This LC combination is the standard value and recommended for most applications.

The TPS6213x can be run with an inductor as low as 1 μH. FSW should be set Low in this case. However, for applications running with the low frequency setting (FSW = High) or with low input voltages, 2.2 μH is recommended.

9.2.2.2.1 Inductor Selection

The inductor selection is affected by several effects like inductor ripple current, output ripple voltage, PWM-to-PSM transition point, and efficiency. In addition, the inductor selected has to be rated for appropriate saturation current and DC resistance (DCR). Equation 7 and Equation 8 calculate the maximum inductor current under static load conditions.

$$I_{L(max)} = I_{OUT(max)} + \frac{\Delta I_{L(max)}}{2} \quad (7)$$

$$\Delta I_{L(\max)} = V_{OUT} \cdot \left(\frac{1 - \frac{V_{OUT}}{V_{IN(\max)}}}{L_{(\min)} \cdot f_{SW}} \right) \quad (8)$$

where

- $I_{L(\max)}$ is the maximum inductor current.
- ΔI_L is the peak-to-peak inductor ripple current.
- $L_{(\min)}$ is the minimum effective inductor value.
- f_{SW} is the actual PWM switching frequency.

Calculating the maximum inductor current using the actual operating conditions gives the required minimum saturation current of the inductor. It is recommended to add a margin of approximately 20%. A larger inductor value is also useful to get lower ripple current, but increases the transient response time and size as well. The following inductors have been used with the TPS6213x and are recommended for use:

Table 9-3. List Of Inductors

TYPE	INDUCTANCE [μ H]	CURRENT [A] ⁽¹⁾	DIMENSIONS [L × B × H] mm	MANUFACTURER ⁽²⁾
XFL4020-102ME_	1.0 μ H, \pm 20%	4.7	4 × 4 × 2.1	Coilcraft
XFL4020-152ME_	1.5 μ H, \pm 20%	4.2	4 × 4 × 2.1	Coilcraft
XFL4020-222ME_	2.2 μ H, \pm 20%	3.8	4 × 4 × 2.1	Coilcraft
IHLP1212BZ-11	1.0 μ H, \pm 20%	4.5	3 × 3.6 × 2	Vishay
IHLP1212BZ-11	2.2 μ H, \pm 20%	3.0	3 × 3.6 × 2	Vishay
SRP4020-3R3M	3.3 μ H, \pm 20%	3.3	4.8 × 4 × 2	Bourns
VLC5045T-3R3N	3.3 μ H, \pm 30%	4.0	5 × 5 × 4.5	TDK

(1) Lower of I_{RMS} at 40°C rise or I_{SAT} at 30% drop.

(2) See the [Third-Party Products Disclaimer](#).

The inductor value also determines the load current at which power save mode is entered:

$$I_{load(PSM)} = \frac{1}{2} \Delta I_L \quad (9)$$

Using [Equation 9](#), this current level can be adjusted by changing the inductor value.

9.2.2.2.2 Capacitor Selection

9.2.2.2.2.1 Output Capacitor

The recommended value for the output capacitor is 22 μ F. The architecture of the TPS6213x allows the use of tiny ceramic output capacitors with low-equivalent series resistance (ESR). These capacitors provide low output voltage ripple and are recommended. To keep its low resistance up to high frequencies and to get narrow capacitance variation with temperature, it is recommended to use X7R or X5R dielectric. Using a higher value can have some advantages like smaller voltage ripple and a tighter DC output accuracy in power save mode (see [Optimizing the TPS62130/40/50/60 Output Filter Application Report](#)).

Note

In power save mode, the output voltage ripple depends on the output capacitance, its ESR, and the peak inductor current. Using ceramic capacitors provides small ESR and low ripple.

9.2.2.2.2.2 Input Capacitor

For most applications, 10 μ F will be sufficient and is recommended, though a larger value reduces input current ripple further. The input capacitor buffers the input voltage for transient events and also decouples the converter

from the supply. A low-ESR multilayer ceramic capacitor is recommended for best filtering and should be placed between PVIN and PGND as close as possible to those pins. Even though AVIN and PVIN must be supplied from the same input source, it is required to place a capacitance of 0.1 μF from AVIN to AGND, to avoid potential noise coupling. An RC, low-pass filter from PVIN to AVIN can be used but is not required.

9.2.2.2.3 Soft-Start Capacitor

A capacitance connected between the SS/TR pin and AGND allows a user-programmable start-up slope of the output voltage. A constant current source supports 2.5 μA to charge the external capacitance. The capacitor required for a given soft-start ramp time for the output voltage is given by:

$$C_{SS} = t_{SS} \cdot \frac{2.5\mu\text{A}}{1.25\text{V}} \quad [\text{F}] \quad (10)$$

where

- C_{SS} is the capacitance (F) required at the SS/TR pin.
- t_{SS} is the desired soft-start ramp time (s).

Note

DC Bias effect: High capacitance ceramic capacitors have a DC Bias effect, which will have a strong influence on the final effective capacitance. Therefore the right capacitor value has to be chosen carefully. Package size and voltage rating in combination with dielectric material are responsible for differences between the rated capacitor value and the effective capacitance.

9.2.2.3 Tracking Function

If a tracking function is desired, the SS/TR pin can be used for this purpose by connecting it to an external tracking voltage. The output voltage tracks that voltage. If the tracking voltage is between 50 mV and 1.2 V, the FB pin will track the SS/TR pin voltage as described in Equation 11 and shown in Figure 9-2.

$$V_{FB} \approx 0.64 \cdot V_{SS/TR} \quad (11)$$

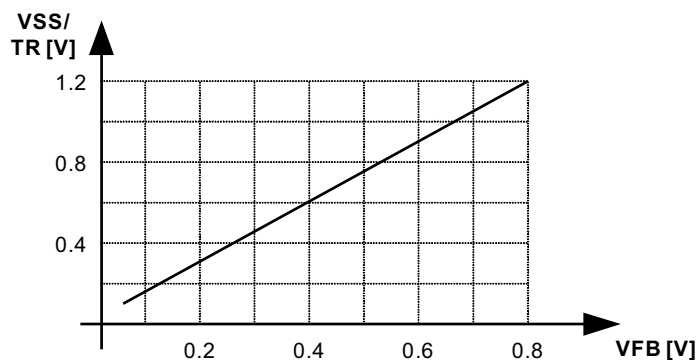
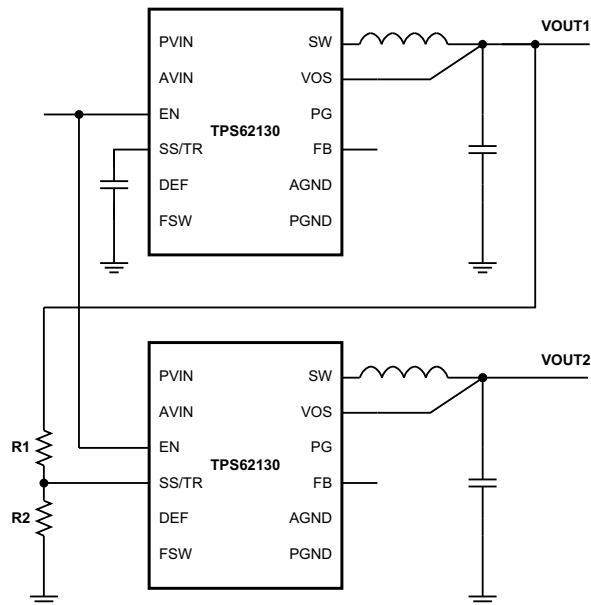

Figure 9-2. Voltage Tracking Relationship

Once the SS/TR pin voltage reaches approximately 1.2 V, the internal voltage is clamped to the internal feedback voltage and device goes to normal regulation. This works for rising and falling tracking voltages with the same behavior, as long as the input voltage is inside the recommended operating conditions. For decreasing SS/TR pin voltage, the device does not sink current from the output. So, the resulting decrease of the output voltage can be slower than the SS/TR pin voltage if the load is light. When driving the SS/TR pin with an external voltage, do not exceed the voltage rating of the SS/TR pin which is $V_{IN} + 0.3\text{ V}$.

If the input voltage drops into undervoltage lockout or even down to zero, the output voltage will go to zero, independent of the tracking voltage. Figure 9-3 shows how to connect devices to get ratiometric and simultaneous sequencing by using the tracking function.



Copyright © 2016, Texas Instruments Incorporated

Figure 9-3. Sequence For Ratiometric And Simultaneous Start-Up

The resistive divider of R1 and R2 can be used to change the ramp rate of V_{OUT2} faster, slower, or the same as V_{OUT1} .

A sequential start-up is achieved by connecting the PG pin of V_{OUT1} to the EN pin of V_{OUT2} . A ratiometric start-up sequence happens if both supplies are sharing the same soft-start capacitor. Equation 10 calculates the soft-start time, though the SS/TR current has to be doubled. Details about these and other tracking and sequencing circuits are found in [Sequencing and Tracking With the TPS621-Family and TPS821-Family Application Report](#).

Note

If the voltage at the FB pin is below its typical value of 0.8 V, the output voltage accuracy may have a wider tolerance than specified.

9.2.2.4 Output Filter And Loop Stability

The devices of the TPS6213x family are internally compensated to be stable with L-C filter combinations corresponding to a corner frequency to be calculated with Equation 12:

$$f_{LC} = \frac{1}{2\pi \sqrt{L \cdot C}} \tag{12}$$

Proven nominal values for inductance and ceramic capacitance are given in Table 9-2 and are recommended for use. Different values can work, but care has to be taken on the loop stability which will be affected. More information including a detailed LC stability matrix can be found in [Optimizing the TPS62130/40/50/60 Output Filter Application Report](#).

The TPS6213x devices, both fixed and adjustable output voltage versions, include an internal 25-pF feedforward capacitor, connected between the VOS and FB pins. This capacitor impacts the frequency behavior and sets a pole and zero in the control loop with the resistors of the feedback divider, per Equation 13 and Equation 14:

$$f_{zero} = \frac{1}{2\pi \cdot R_1 \cdot 25 pF} \tag{13}$$

$$f_{pole} = \frac{1}{2\pi \cdot 25 pF} \cdot \left(\frac{1}{R_1} + \frac{1}{R_2} \right) \quad (14)$$

Though the TPS6213x devices are stable without the pole and zero being in a particular location, adjusting their location to the specific needs of the application can provide better performance in power save mode, improved transient response, or both. An external feedforward capacitor can also be added. A more detailed discussion on the optimization for stability versus transient response can be found in [Optimizing Transient Response of Internally Compensated DC-DC Converters Application Report](#) and [Feedforward Capacitor to Improve Stability and Bandwidth of TPS621/821-Family Application Report](#).

9.2.3 Application Curves

$V_{IN} = 12\text{ V}$, $V_{OUT} = 3.3\text{ V}$, $T_A = 25^\circ\text{C}$, (unless otherwise noted)

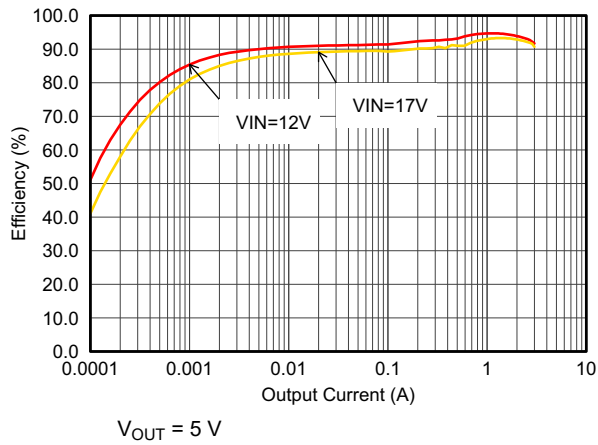

Figure 9-4. Efficiency with 1.25 MHz

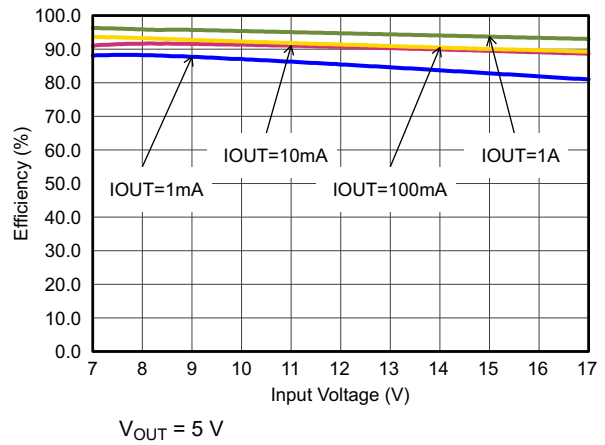

Figure 9-5. Efficiency with 1.25 MHz

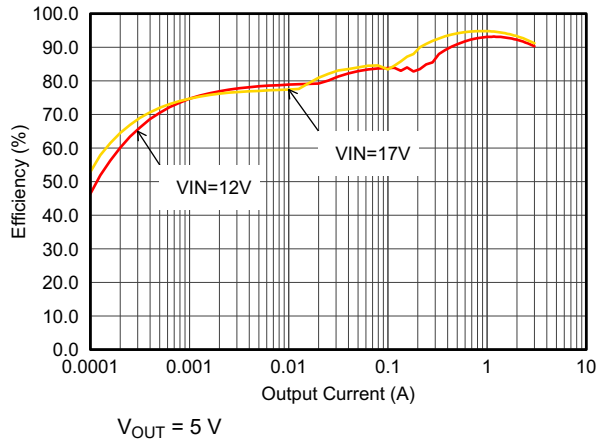

Figure 9-6. Efficiency with 2.5 MHz

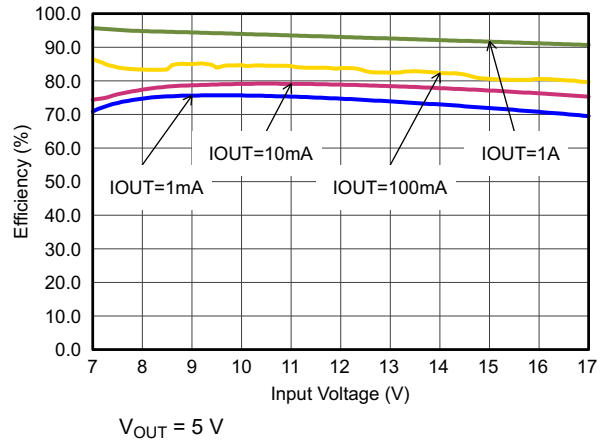

Figure 9-7. Efficiency with 2.5 MHz

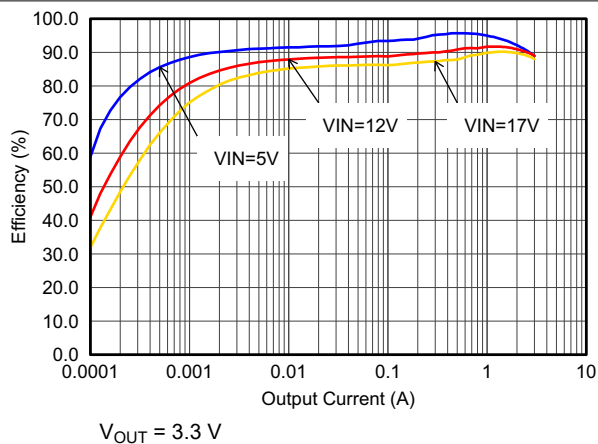

Figure 9-8. Efficiency with 1.25 MHz

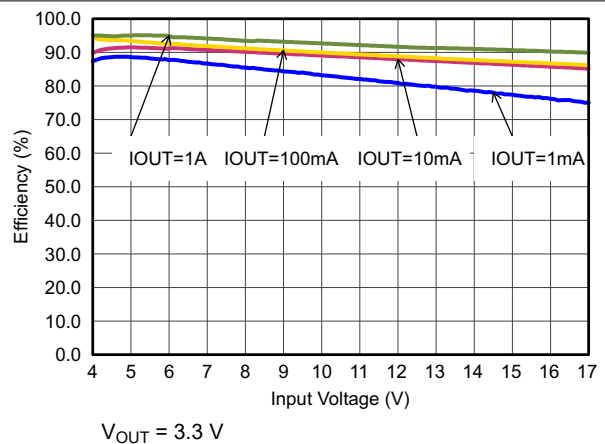
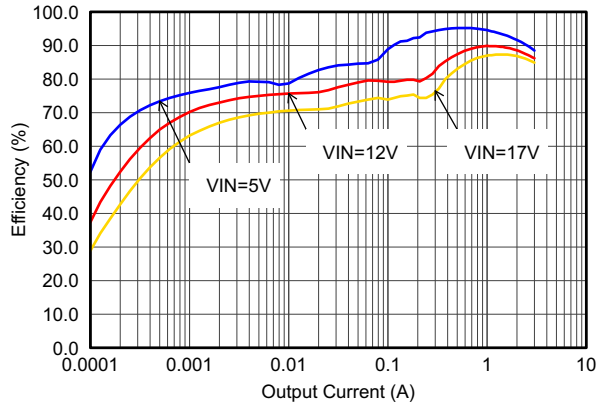
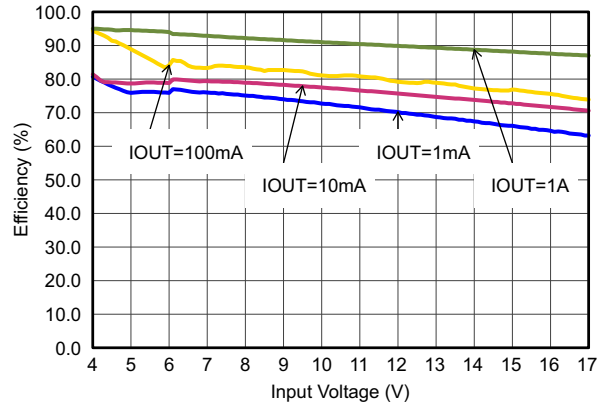

Figure 9-9. Efficiency with 1.25 MHz



$V_{OUT} = 3.3\text{ V}$

Figure 9-10. Efficiency with 2.5 MHz



$V_{OUT} = 3.3\text{ V}$

Figure 9-11. Efficiency with 2.5 MHz

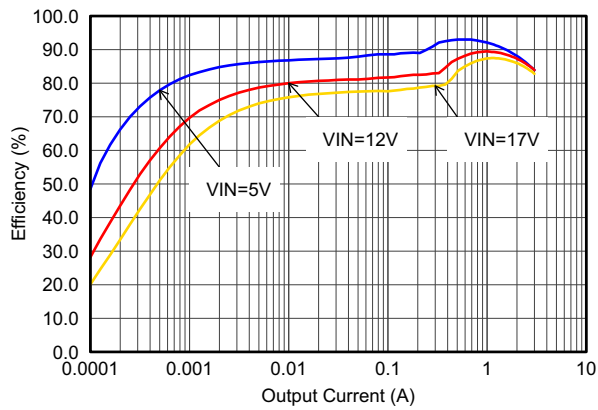

$V_{OUT} = 1.8\text{ V}$

Figure 9-12. Efficiency with 1.25 MHz

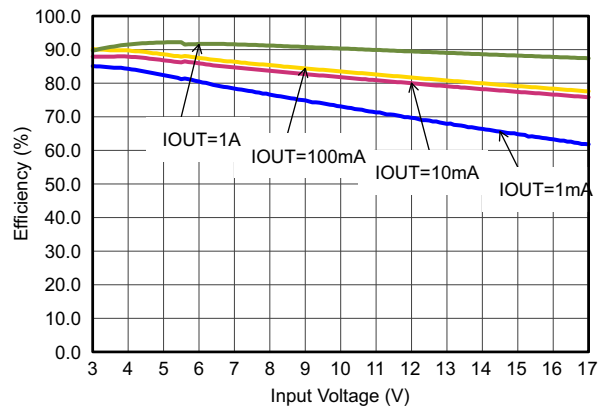

$V_{OUT} = 1.8\text{ V}$

Figure 9-13. Efficiency with 1.25 MHz

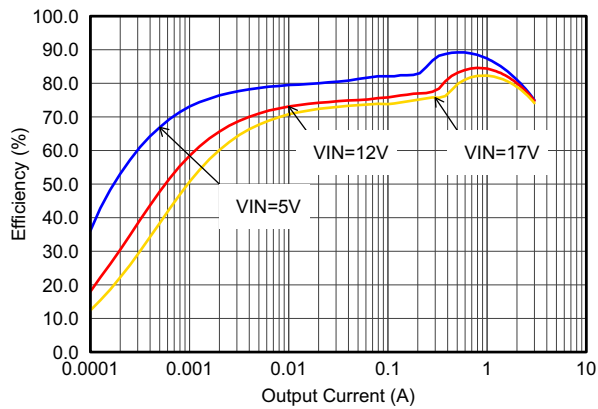

$V_{OUT} = 0.9\text{ V}$

Figure 9-14. Efficiency with 1.25 MHz

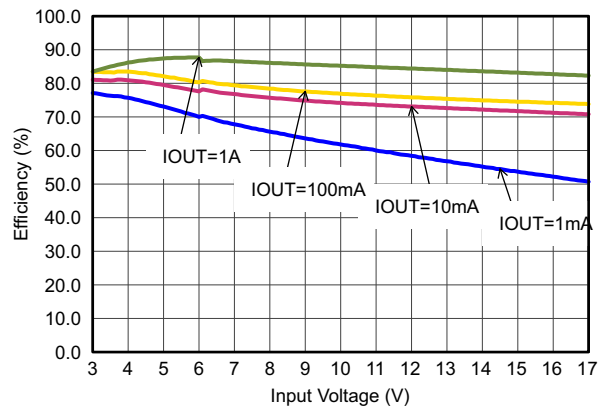

$V_{OUT} = 0.9\text{ V}$

Figure 9-15. Efficiency with 1.25 MHz

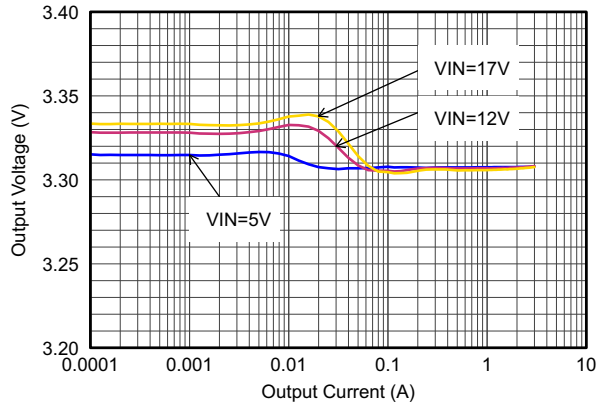

Figure 9-16. Output Voltage Accuracy (Load Regulation)

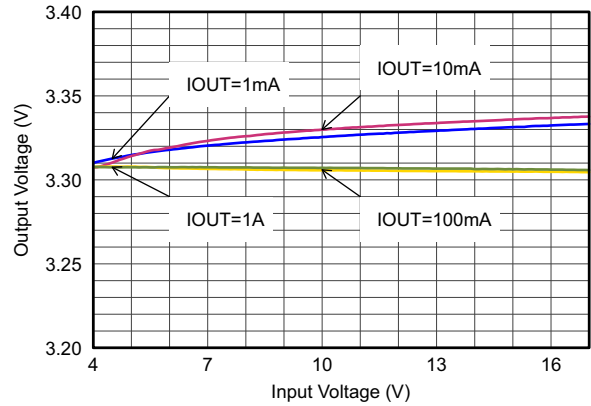

Figure 9-17. Output Voltage Accuracy (Line Regulation)

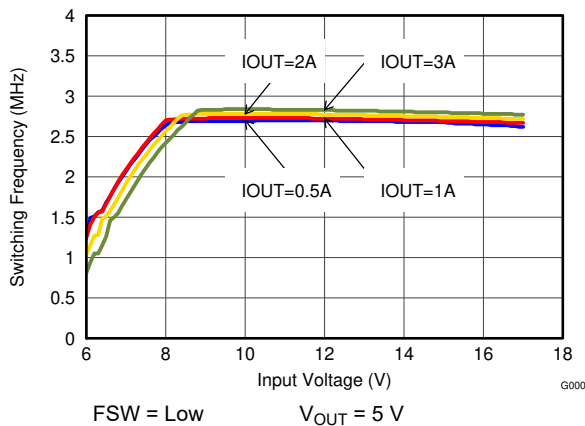

Figure 9-18. Switching Frequency vs Input Voltage

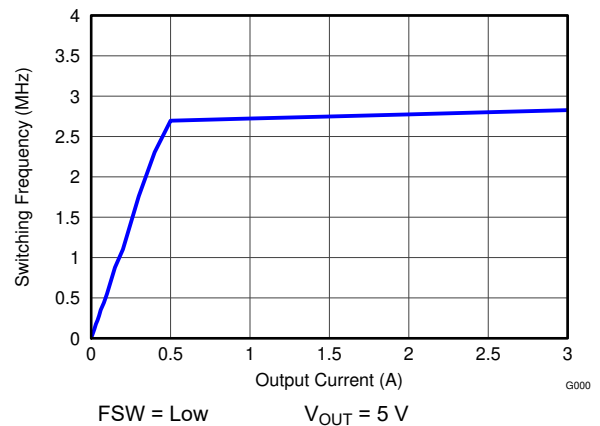

Figure 9-19. Switching Frequency vs Output Current

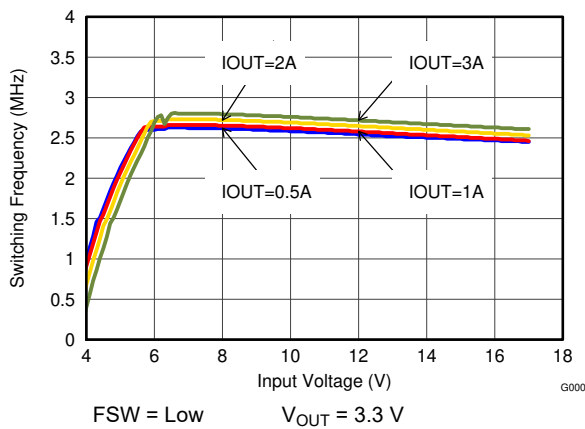

Figure 9-20. Switching Frequency vs Input Voltage

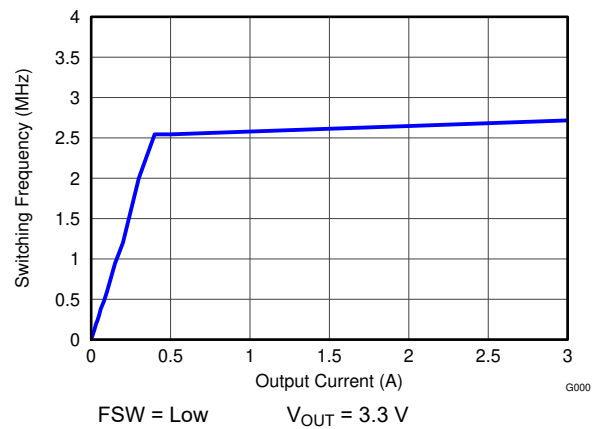

Figure 9-21. Switching Frequency vs Output Current,

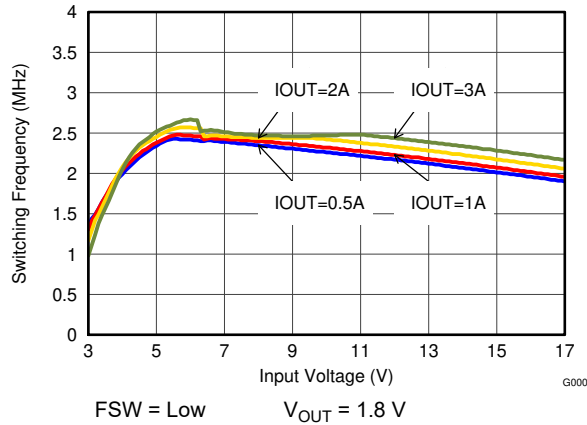

Figure 9-22. Switching Frequency vs Input Voltage

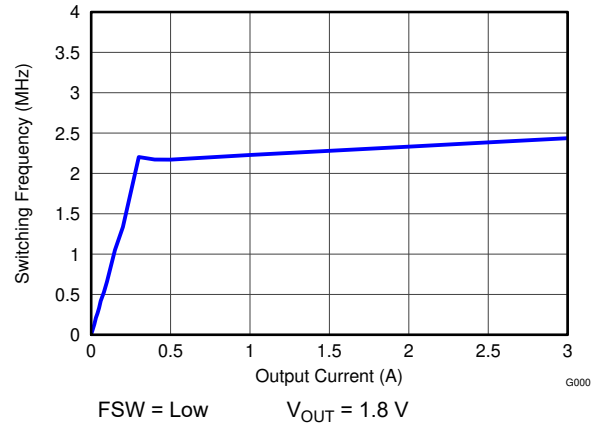

Figure 9-23. Switching Frequency vs Output Current

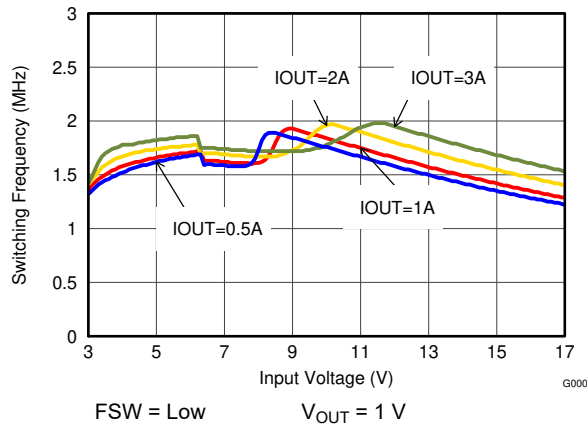

Figure 9-24. Switching Frequency vs Input Voltage

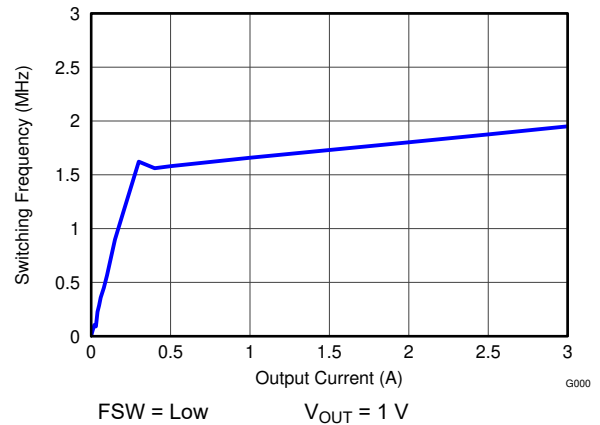

Figure 9-25. Switching Frequency vs Output Current

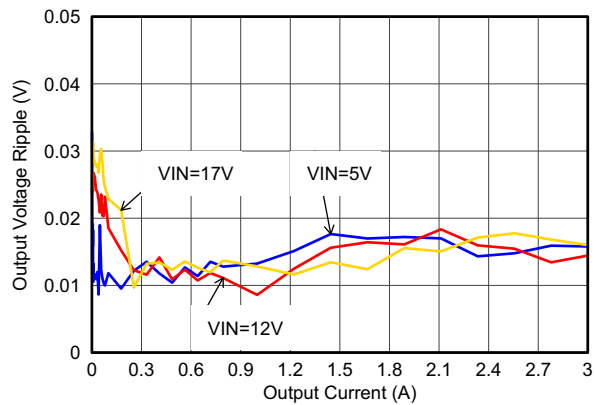

Figure 9-26. Output Voltage Ripple

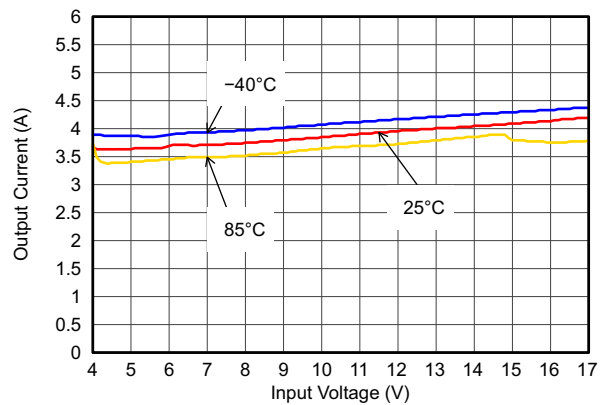

Figure 9-27. Maximum Output Current

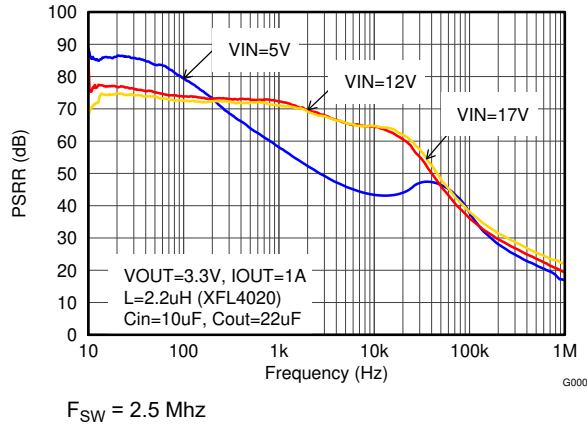

Figure 9-28. Power Supply Rejection Ratio

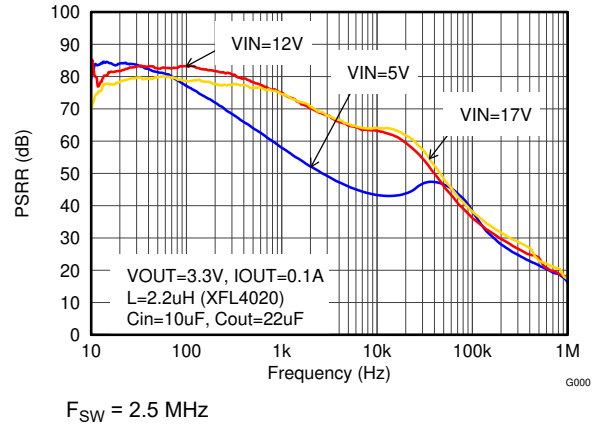

Figure 9-29. Power Supply Rejection Ratio

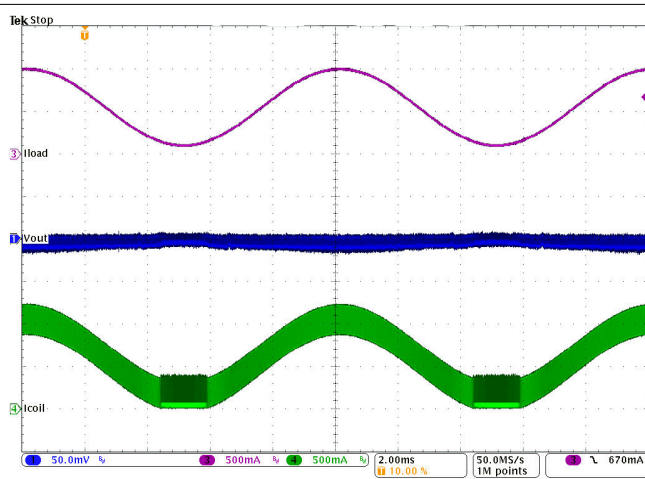

Figure 9-30. PWM-PSM-Transition

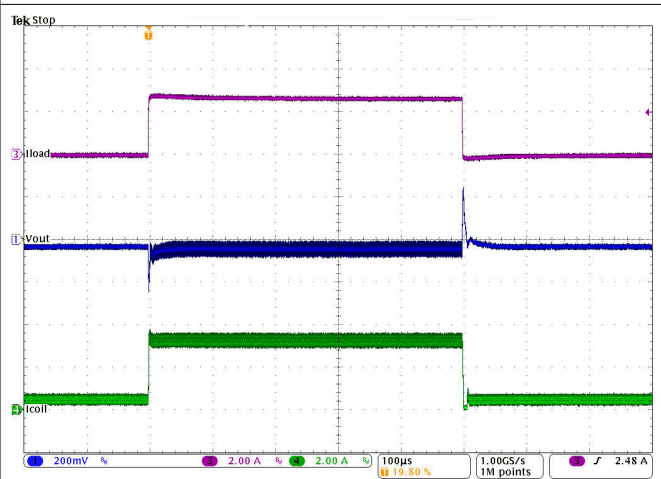

Figure 9-31. Load Transient Response

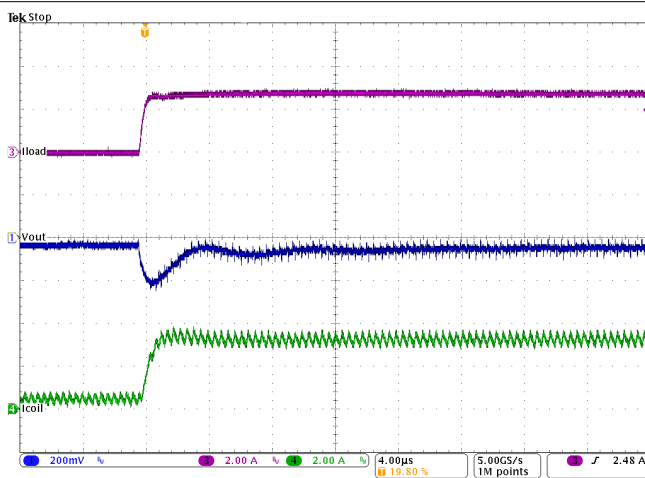

Figure 9-32. Load Transient Response of Figure 9-31, Rising Edge

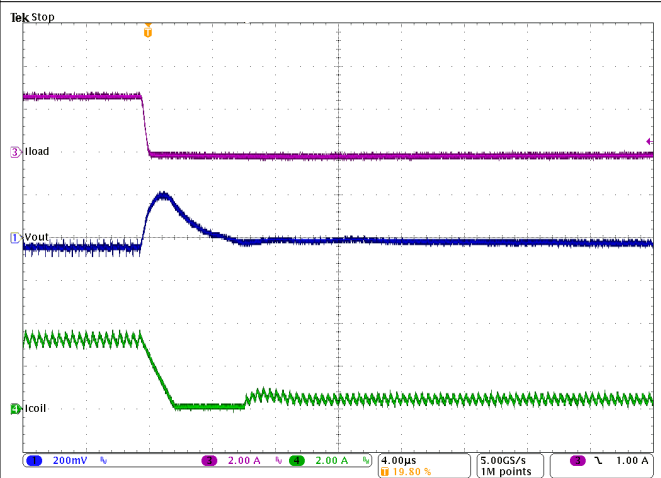

Figure 9-33. Load Transient Response of Figure 9-31, Falling Edge

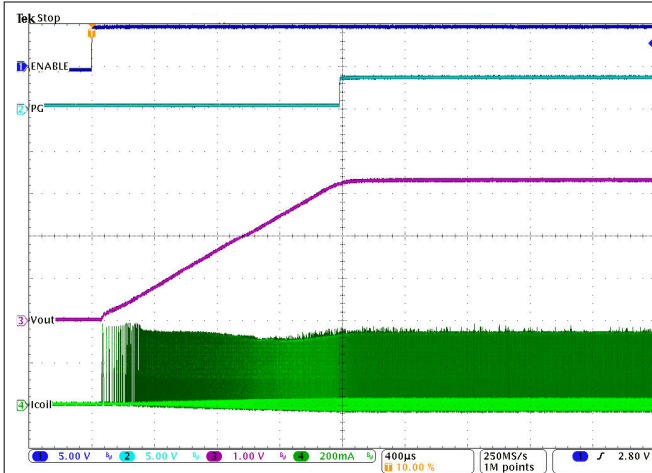

Figure 9-34. Start-Up Into 100 mA

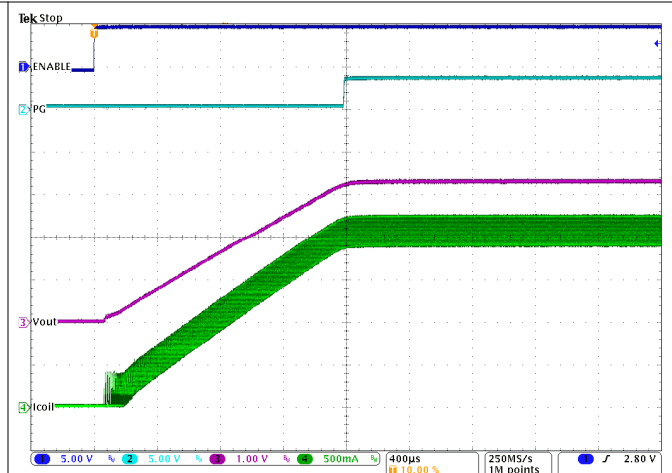
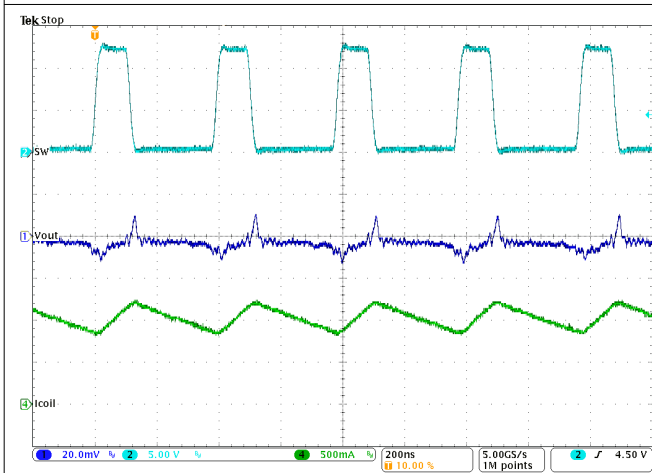
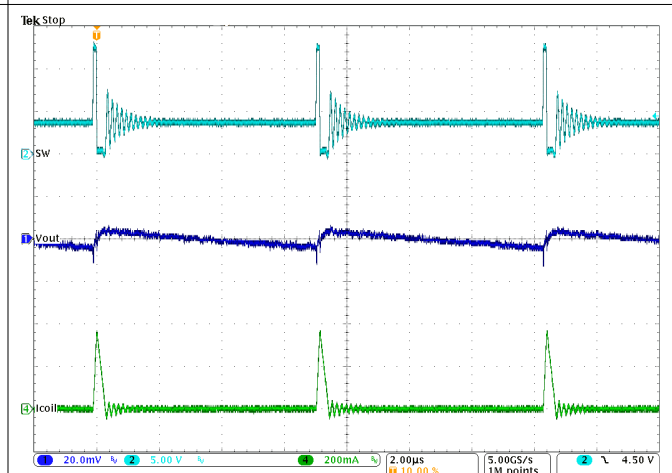

Figure 9-35. Start-Up Into 3 A



$I_{OUT} = 1\text{ A}$

Figure 9-36. Typical Operation In PWM Mode



$I_{OUT} = 10\text{ mA}$

Figure 9-37. Typical Operation In Power Save Mode

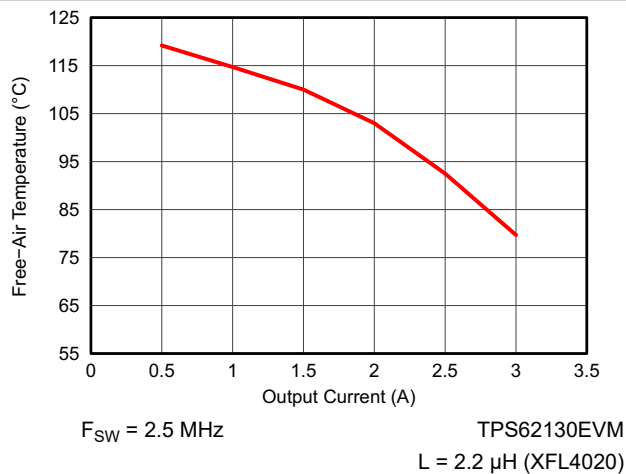

Figure 9-38. Maximum Ambient Temperature

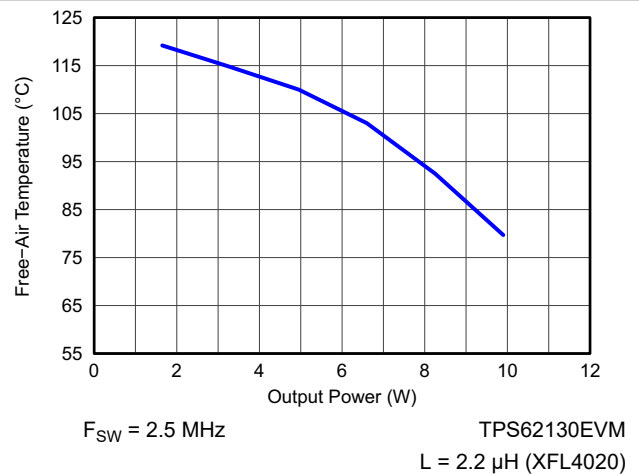

Figure 9-39. Maximum Ambient Temperature

9.3 System Examples

9.3.1 LED Power Supply

The TPS62130 can be used as a power supply for power LEDs. The FB pin can be easily set down to lower values than nominal by using the SS/TR pin. With that, the voltage drop on the sense resistor is low to avoid excessive power loss. Since this pin provides 2.5 μA , the feedback pin voltage can be adjusted by an external resistor per Equation 15. This drop, proportional to the LED current, is used to regulate the output voltage (anode voltage) to a proper level to drive the LED. Both analog and PWM dimming are supported with the TPS62130. Figure 9-40 shows an application circuit, tested with analog dimming:

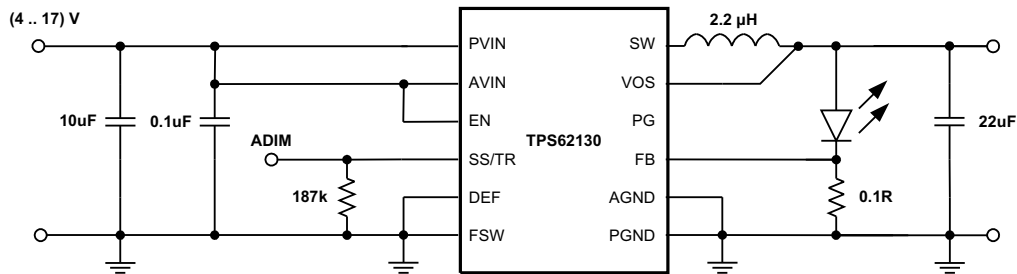

Figure 9-40. Single Power LED Supply

The resistor at SS/TR sets the FB voltage to a level of approximately 300 mV and is calculated from Equation 15.

$$V_{FB} = 0.64 \cdot 2.5\mu\text{A} \cdot R_{SS/TR} \quad (15)$$

The device now supplies a constant current, set by the resistor at the FB pin, by regulating the output voltage accordingly. The minimum input voltage has to be rated according the forward voltage needed by the LED used. More information is available in the [Step-Down LED Driver With Dimming With the TPS621-Family and TPS821-Family Application Report](#).

9.3.2 Active Output Discharge

The TPS62130A pulls the PG pin Low when the device is shut down by EN, UVLO, or thermal shutdown. Connecting PG to V_{OUT} through a resistor can be used to discharge V_{OUT} in those cases (see Figure 9-41). The discharge rate can be adjusted by R3, which is also used to pull up the PG pin in normal operation. For reliability, keep the maximum current into the PG pin less than 10 mA.

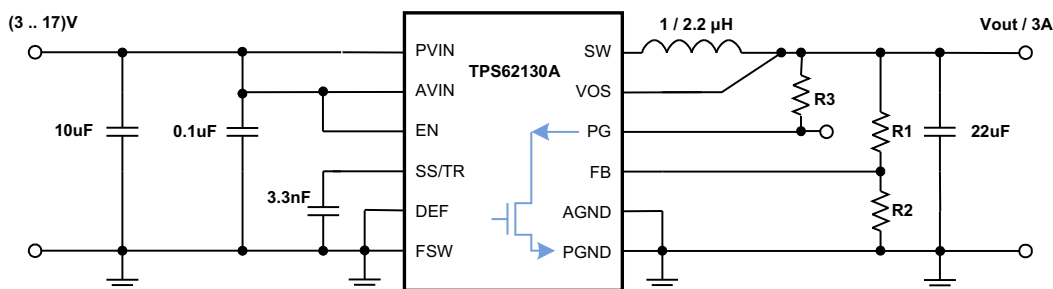

Figure 9-41. Discharge V_{OUT} Through PG Pin with TPS62130A

9.3.3 –3.3-V Inverting Power Supply

The TPS62130 can be used as an inverting power supply by rearranging external circuitry as shown in Figure 9-42. As the former GND node now represents a voltage level below system ground, the voltage difference between V_{IN} and V_{OUT} has to be limited for operation to the maximum supply voltage of 17 V (see Equation 16).

$$V_{IN} + |V_{OUT}| \leq V_{INmax} \quad (16)$$

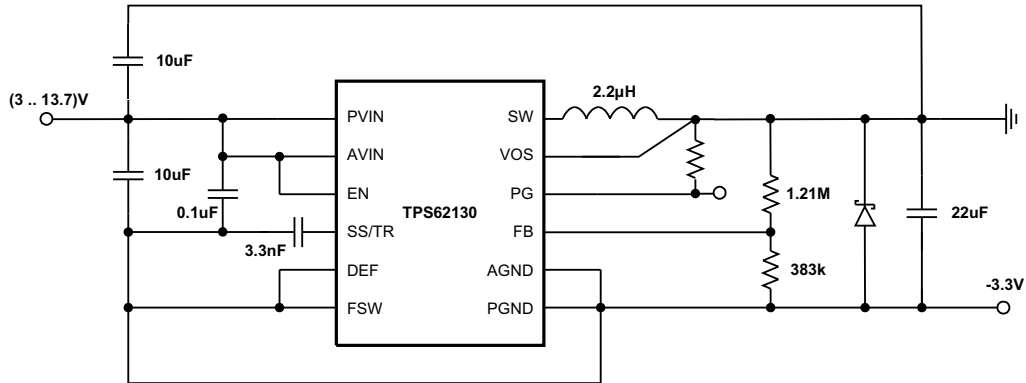

Figure 9-42. -3.3-V Inverting Power Supply

The transfer function of the inverting power supply configuration differs from the buck mode transfer function, incorporating a right half plane zero additionally. The loop stability has to be adapted and an output capacitance of at least 22 µF is recommended. A detailed design example is given in [Using the TPS6215x in an Inverting Buck-Boost Topology Application Report](#).

9.3.4 Various Output Voltages

The following example circuits show how to use the various devices and configure the external circuitry to furnish different output voltages at 3 A.

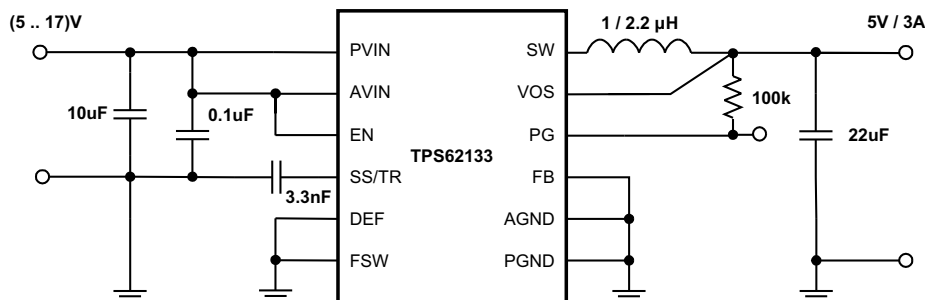

Figure 9-43. 5-V/3-A Power Supply

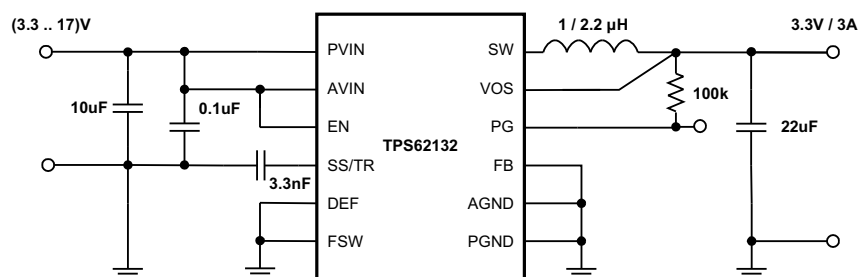

Figure 9-44. 3.3-V/3-A Power Supply

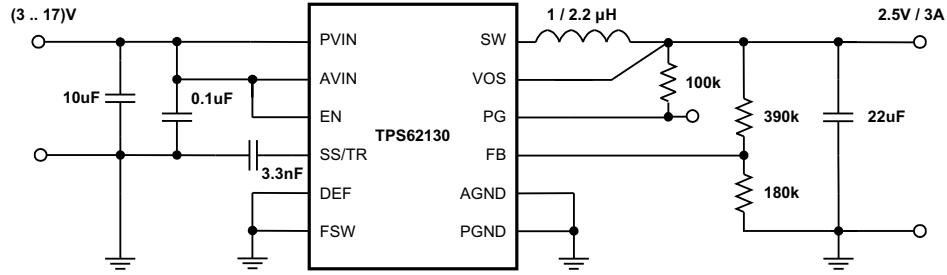

Figure 9-45. 2.5-V/3-A Power Supply

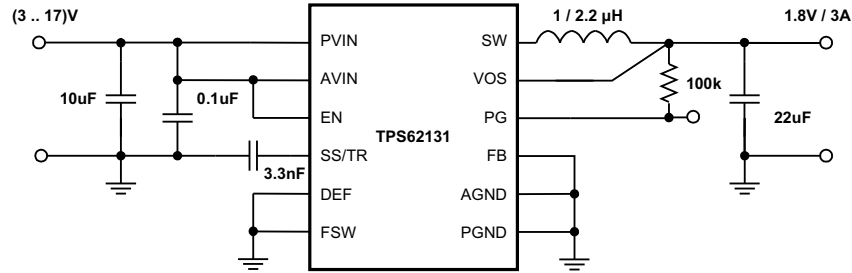

Figure 9-46. 1.8-V/3-A Power Supply

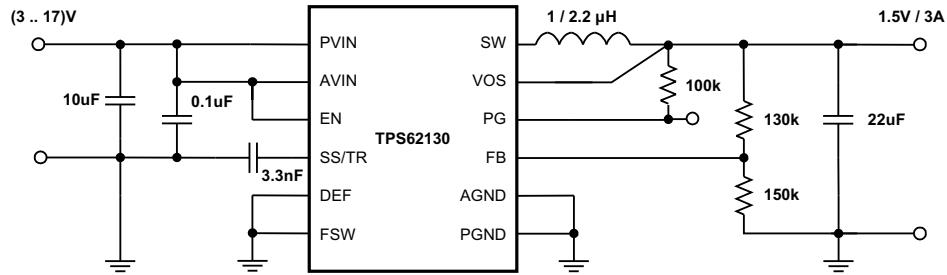

Figure 9-47. 1.5-V/3-A Power Supply

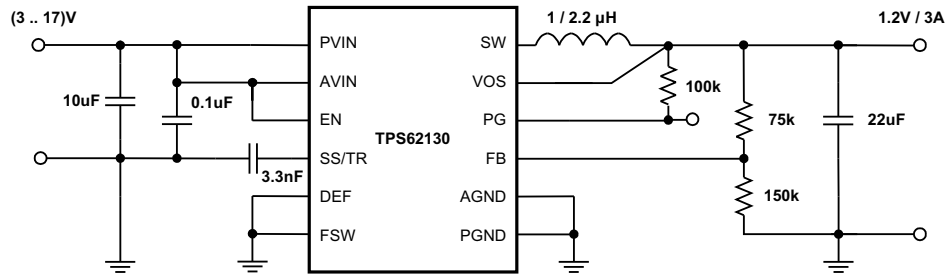

Figure 9-48. 1.2-V/3-A Power Supply

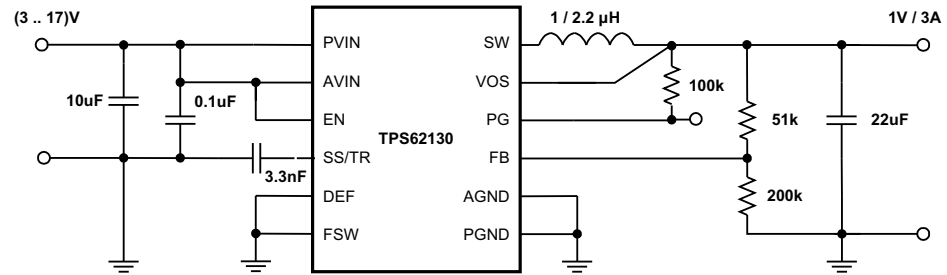

Figure 9-49. 1-V/3-A Power Supply

10 Power Supply Recommendations

The TPS6213x are designed to operate from a 3-V to 17-V input voltage supply. The output current of the input power supply needs to be rated according to the output voltage and the output current of the power rail application.

11 Layout

11.1 Layout Guidelines

A proper layout is critical for the operation of a switched mode power supply, even more at high switching frequencies. Therefore, the PCB layout of the TPS6213x demands careful attention to ensure operation and to get the performance specified. A poor layout can lead to issues like the following:

- Poor regulation (both line and load)
- Stability and accuracy weaknesses
- Increased EMI radiation
- Noise sensitivity

See [Figure 11-1](#) for the recommended layout of the TPS6213x, which is designed for common external ground connections. Therefore, both AGND and PGND pins are directly connected to the exposed thermal pad. On the PCB, the direct common ground connection of AGND and PGND to the exposed thermal pad and the system ground (ground plane) is mandatory. Also connect the VOS pin in the shortest way to V_{OUT} at the output capacitor. To avoid noise coupling into the VOS line, this connection should be separated from the V_{OUT} power line/plane as shown in [Section 11.2](#).

Provide low inductive and resistive paths for loops with high di/dt . Therefore, paths conducting the switched load current should be as short and wide as possible. Provide low capacitive paths (with respect to all other nodes) for wires with high dv/dt . Therefore, the input and output capacitance should be placed as close as possible to the IC pins and parallel wiring over long distances as well as narrow traces should be avoided. Loops which conduct an alternating current should outline an area as small as possible, as this area is proportional to the energy radiated.

Sensitive nodes like FB and VOS need to be connected with short wires and not nearby high dv/dt signals (for example, SW). As they carry information about the output voltage, they should be connected as close as possible to the actual output voltage (at the output capacitor). The capacitor on the SS/TR pin and on AVIN as well as the FB resistors, R1 and R2, should be kept close to the IC and connect directly to those pins and the system ground plane.

The exposed thermal pad must be soldered to the circuit board for mechanical reliability and to achieve appropriate power dissipation.

The recommended layout is implemented on the EVM and shown in the [TPS6213x Buck Converter Evaluation Module User's Guide](#). Additionally, the [Gebers for HPA505 EVM](#) are available for download.

12 Device and Documentation Support

12.1 Device Support

12.1.1 Third-Party Products Disclaimer

TI'S PUBLICATION OF INFORMATION REGARDING THIRD-PARTY PRODUCTS OR SERVICES DOES NOT CONSTITUTE AN ENDORSEMENT REGARDING THE SUITABILITY OF SUCH PRODUCTS OR SERVICES OR A WARRANTY, REPRESENTATION OR ENDORSEMENT OF SUCH PRODUCTS OR SERVICES, EITHER ALONE OR IN COMBINATION WITH ANY TI PRODUCT OR SERVICE.

12.2 Documentation Support

12.2.1 Related Documentation

- Texas Instruments, [Voltage Margining Using the TPS62130 Application Report](#)
- Texas Instruments, [Using the TPS62150 as Step-Down LED Driver With Dimming Application Report](#)
- Texas Instruments, [Using the TPS6215x in an Inverting Buck-Boost Topology Application Report](#)
- Texas Instruments, [Optimizing the TPS62130/40/50/60/70 Output Filter Application Report](#)
- Texas Instruments, [TPS62130/40/50 Sequencing and Tracking Application Report](#)
- Texas Instruments, [Optimizing Transient Response of Internally Compensated dc-dc Converters With Feedforward Capacitor Application Report](#)
- Texas Instruments, [Using a Feedforward Capacitor to Improve Stability and Bandwidth of TPS62130/40/50/60/70 Application Report](#)
- Texas Instruments, [Thermal Characteristics of Linear and Logic Packages Using JEDEC PCB Designs Application Report](#)
- Texas Instruments, [Semiconductor and IC Package Thermal Metrics Application Report](#)
- Texas Instruments, [TPS62130EVM-505, TPS62140EVM-505, and TPS62150EVM-505 Evaluation Modules User's Guide](#)
- Texas Instruments, [EVM Gerber Data](#)

12.3 Receiving Notification of Documentation Updates

To receive notification of documentation updates, navigate to the device product folder on ti.com. Click on *Subscribe to updates* to register and receive a weekly digest of any product information that has changed. For change details, review the revision history included in any revised document.

12.4 Support Resources

TI E2E™ [support forums](#) are an engineer's go-to source for fast, verified answers and design help — straight from the experts. Search existing answers or ask your own question to get the quick design help you need.

Linked content is provided "AS IS" by the respective contributors. They do not constitute TI specifications and do not necessarily reflect TI's views; see TI's [Terms of Use](#).

12.5 Trademarks

DCS-Control™ and TI E2E™ are trademarks of Texas Instruments.
All trademarks are the property of their respective owners.

12.6 Electrostatic Discharge Caution



This integrated circuit can be damaged by ESD. Texas Instruments recommends that all integrated circuits be handled with appropriate precautions. Failure to observe proper handling and installation procedures can cause damage.

ESD damage can range from subtle performance degradation to complete device failure. Precision integrated circuits may be more susceptible to damage because very small parametric changes could cause the device not to meet its published specifications.

12.7 Glossary

[TI Glossary](#) This glossary lists and explains terms, acronyms, and definitions.

13 Mechanical, Packaging, and Orderable Information

The following pages include mechanical, packaging, and orderable information. This information is the most current data available for the designated devices. This data is subject to change without notice and revision of this document. For browser-based versions of this data sheet, refer to the left-hand navigation.

PACKAGING INFORMATION

Orderable Device	Status (1)	Package Type	Package Drawing	Pins	Package Qty	Eco Plan (2)	Lead finish/ Ball material (6)	MSL Peak Temp (3)	Op Temp (°C)	Device Marking (4/5)	Samples
TPS62130ARGTR	ACTIVE	VQFN	RGT	16	3000	RoHS & Green	NIPDAU	Level-2-260C-1 YEAR	-40 to 125	PA6I	Samples
TPS62130ARGTT	ACTIVE	VQFN	RGT	16	250	RoHS & Green	NIPDAU	Level-2-260C-1 YEAR	-40 to 125	PA6I	Samples
TPS62130RGTR	ACTIVE	VQFN	RGT	16	3000	RoHS & Green	NIPDAU	Level-2-260C-1 YEAR	-40 to 125	PTSI	Samples
TPS62130RGTT	ACTIVE	VQFN	RGT	16	250	RoHS & Green	NIPDAU	Level-2-260C-1 YEAR	-40 to 125	PTSI	Samples
TPS62131RGTR	ACTIVE	VQFN	RGT	16	3000	RoHS & Green	NIPDAU	Level-2-260C-1 YEAR	-40 to 125	QVX	Samples
TPS62131RGTT	ACTIVE	VQFN	RGT	16	250	RoHS & Green	NIPDAU	Level-2-260C-1 YEAR	-40 to 125	QVX	Samples
TPS62132RGTR	ACTIVE	VQFN	RGT	16	3000	RoHS & Green	NIPDAU	Level-2-260C-1 YEAR	-40 to 125	QVY	Samples
TPS62132RGTT	ACTIVE	VQFN	RGT	16	250	RoHS & Green	NIPDAU	Level-2-260C-1 YEAR	-40 to 125	QVY	Samples
TPS62133RGTR	ACTIVE	VQFN	RGT	16	3000	RoHS & Green	NIPDAU	Level-2-260C-1 YEAR	-40 to 125	QVZ	Samples
TPS62133RGTT	ACTIVE	VQFN	RGT	16	250	RoHS & Green	NIPDAU	Level-2-260C-1 YEAR	-40 to 125	QVZ	Samples

(1) The marketing status values are defined as follows:

ACTIVE: Product device recommended for new designs.

LIFEBUY: TI has announced that the device will be discontinued, and a lifetime-buy period is in effect.

NRND: Not recommended for new designs. Device is in production to support existing customers, but TI does not recommend using this part in a new design.

PREVIEW: Device has been announced but is not in production. Samples may or may not be available.

OBSOLETE: TI has discontinued the production of the device.

(2) **RoHS:** TI defines "RoHS" to mean semiconductor products that are compliant with the current EU RoHS requirements for all 10 RoHS substances, including the requirement that RoHS substance do not exceed 0.1% by weight in homogeneous materials. Where designed to be soldered at high temperatures, "RoHS" products are suitable for use in specified lead-free processes. TI may reference these types of products as "Pb-Free".

RoHS Exempt: TI defines "RoHS Exempt" to mean products that contain lead but are compliant with EU RoHS pursuant to a specific EU RoHS exemption.

Green: TI defines "Green" to mean the content of Chlorine (Cl) and Bromine (Br) based flame retardants meet JS709B low halogen requirements of <=1000ppm threshold. Antimony trioxide based flame retardants must also meet the <=1000ppm threshold requirement.

(3) MSL, Peak Temp. - The Moisture Sensitivity Level rating according to the JEDEC industry standard classifications, and peak solder temperature.

(4) There may be additional marking, which relates to the logo, the lot trace code information, or the environmental category on the device.

⁽⁵⁾ Multiple Device Markings will be inside parentheses. Only one Device Marking contained in parentheses and separated by a "~" will appear on a device. If a line is indented then it is a continuation of the previous line and the two combined represent the entire Device Marking for that device.

⁽⁶⁾ Lead finish/Ball material - Orderable Devices may have multiple material finish options. Finish options are separated by a vertical ruled line. Lead finish/Ball material values may wrap to two lines if the finish value exceeds the maximum column width.

Important Information and Disclaimer:The information provided on this page represents TI's knowledge and belief as of the date that it is provided. TI bases its knowledge and belief on information provided by third parties, and makes no representation or warranty as to the accuracy of such information. Efforts are underway to better integrate information from third parties. TI has taken and continues to take reasonable steps to provide representative and accurate information but may not have conducted destructive testing or chemical analysis on incoming materials and chemicals. TI and TI suppliers consider certain information to be proprietary, and thus CAS numbers and other limited information may not be available for release.

In no event shall TI's liability arising out of such information exceed the total purchase price of the TI part(s) at issue in this document sold by TI to Customer on an annual basis.

OTHER QUALIFIED VERSIONS OF TPS62130A :

- Automotive : [TPS62130A-Q1](#)

NOTE: Qualified Version Definitions:

- Automotive - Q100 devices qualified for high-reliability automotive applications targeting zero defects

TAPE AND REEL INFORMATION

QUADRANT ASSIGNMENTS FOR PIN 1 ORIENTATION IN TAPE

*All dimensions are nominal

Device	Package Type	Package Drawing	Pins	SPQ	Reel Diameter (mm)	Reel Width W1 (mm)	A0 (mm)	B0 (mm)	K0 (mm)	P1 (mm)	W (mm)	Pin1 Quadrant
TPS62130ARGTR	VQFN	RGT	16	3000	330.0	12.4	3.3	3.3	1.1	8.0	12.0	Q2
TPS62130ARGTT	VQFN	RGT	16	250	180.0	12.4	3.3	3.3	1.1	8.0	12.0	Q2
TPS62130RGTR	VQFN	RGT	16	3000	330.0	12.4	3.3	3.3	1.1	8.0	12.0	Q2
TPS62130RGTT	VQFN	RGT	16	250	180.0	12.4	3.3	3.3	1.1	8.0	12.0	Q2
TPS62131RGTR	VQFN	RGT	16	3000	330.0	12.4	3.3	3.3	1.1	8.0	12.0	Q2
TPS62131RGTT	VQFN	RGT	16	250	180.0	12.4	3.3	3.3	1.1	8.0	12.0	Q2
TPS62131RGTT	VQFN	RGT	16	250	180.0	12.4	3.3	3.3	1.1	8.0	12.0	Q2
TPS62132RGTR	VQFN	RGT	16	3000	330.0	12.4	3.3	3.3	1.1	8.0	12.0	Q2
TPS62132RGTR	VQFN	RGT	16	3000	330.0	12.4	3.3	3.3	1.1	8.0	12.0	Q2
TPS62132RGTT	VQFN	RGT	16	250	180.0	12.4	3.3	3.3	1.1	8.0	12.0	Q2
TPS62132RGTT	VQFN	RGT	16	250	180.0	12.4	3.3	3.3	1.1	8.0	12.0	Q2
TPS62133RGTR	VQFN	RGT	16	3000	330.0	12.4	3.3	3.3	1.1	8.0	12.0	Q2
TPS62133RGTT	VQFN	RGT	16	250	180.0	12.4	3.3	3.3	1.1	8.0	12.0	Q2
TPS62133RGTT	VQFN	RGT	16	250	180.0	12.4	3.3	3.3	1.1	8.0	12.0	Q2

TAPE AND REEL BOX DIMENSIONS



*All dimensions are nominal

Device	Package Type	Package Drawing	Pins	SPQ	Length (mm)	Width (mm)	Height (mm)
TPS62130ARGTR	VQFN	RGT	16	3000	552.0	346.0	36.0
TPS62130ARGTT	VQFN	RGT	16	250	552.0	185.0	36.0
TPS62130RGTR	VQFN	RGT	16	3000	552.0	346.0	36.0
TPS62130RGTT	VQFN	RGT	16	250	552.0	185.0	36.0
TPS62131RGTR	VQFN	RGT	16	3000	552.0	346.0	36.0
TPS62131RGTT	VQFN	RGT	16	250	552.0	185.0	36.0
TPS62131RGTT	VQFN	RGT	16	250	210.0	185.0	35.0
TPS62132RGTR	VQFN	RGT	16	3000	552.0	346.0	36.0
TPS62132RGTR	VQFN	RGT	16	3000	367.0	367.0	35.0
TPS62132RGTT	VQFN	RGT	16	250	210.0	185.0	35.0
TPS62132RGTT	VQFN	RGT	16	250	552.0	185.0	36.0
TPS62133RGTR	VQFN	RGT	16	3000	552.0	346.0	36.0
TPS62133RGTT	VQFN	RGT	16	250	210.0	185.0	35.0
TPS62133RGTT	VQFN	RGT	16	250	552.0	185.0	36.0

TUBE

*All dimensions are nominal

Device	Package Name	Package Type	Pins	SPQ	L (mm)	W (mm)	T (μm)	B (mm)
TPS62130ARGTR	RGT	VQFN	16	3000	381	4.83	2286	0
TPS62130ARGTT	RGT	VQFN	16	250	381	4.83	2286	0
TPS62130RGTR	RGT	VQFN	16	3000	381	4.83	2286	0
TPS62130RGTT	RGT	VQFN	16	250	381	4.83	2286	0
TPS62131RGTR	RGT	VQFN	16	3000	381	4.83	2286	0
TPS62131RGTT	RGT	VQFN	16	250	381	4.83	2286	0
TPS62132RGTR	RGT	VQFN	16	3000	381	4.83	2286	0
TPS62132RGTT	RGT	VQFN	16	250	381	4.83	2286	0
TPS62133RGTR	RGT	VQFN	16	3000	381	4.83	2286	0
TPS62133RGTT	RGT	VQFN	16	250	381	4.83	2286	0

RGT 16

GENERIC PACKAGE VIEW

VQFN - 1 mm max height

PLASTIC QUAD FLATPACK - NO LEAD

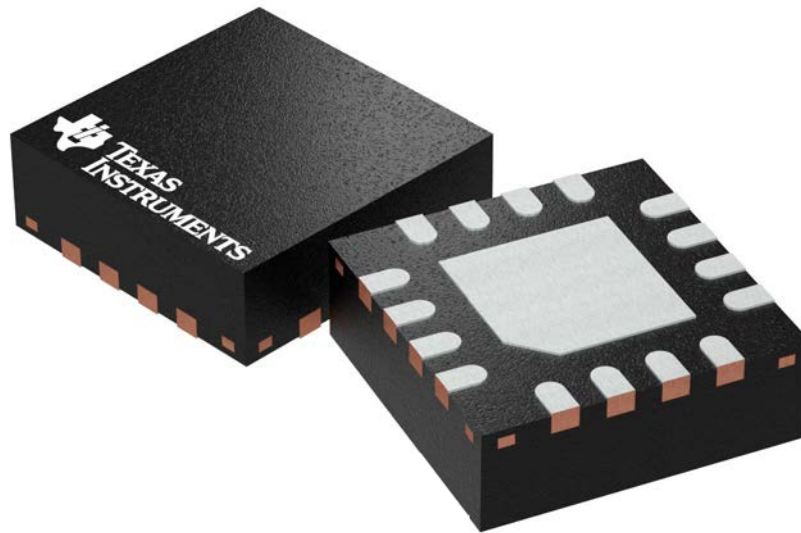

Images above are just a representation of the package family, actual package may vary.
Refer to the product data sheet for package details.

4203495/1

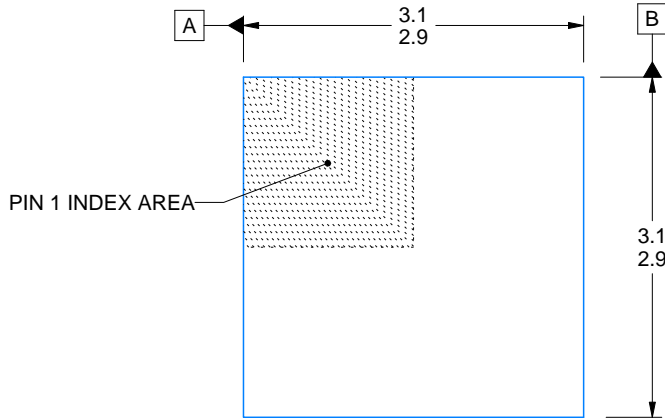
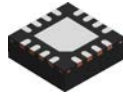

SIDE WALL METAL THICKNESS DIM A	
OPTION 1	OPTION 2
0.1	0.2

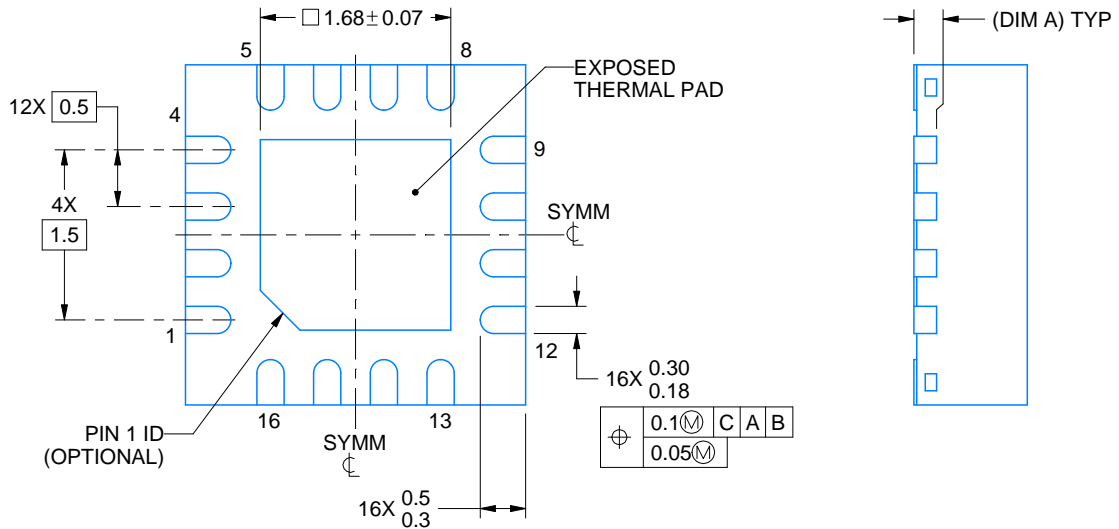
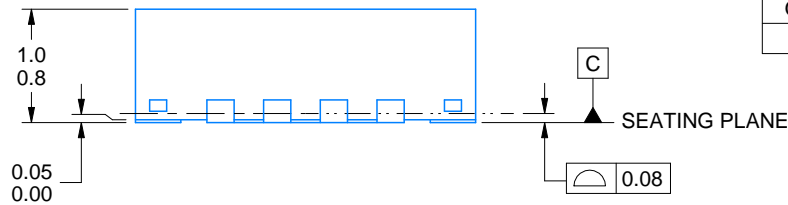

4222419/D 04/2022

NOTES:

1. All linear dimensions are in millimeters. Any dimensions in parenthesis are for reference only. Dimensioning and tolerancing per ASME Y14.5M.
2. This drawing is subject to change without notice.
3. The package thermal pad must be soldered to the printed circuit board for thermal and mechanical performance.

EXAMPLE STENCIL DESIGN

RGT0016C

VQFN - 1 mm max height

PLASTIC QUAD FLATPACK - NO LEAD

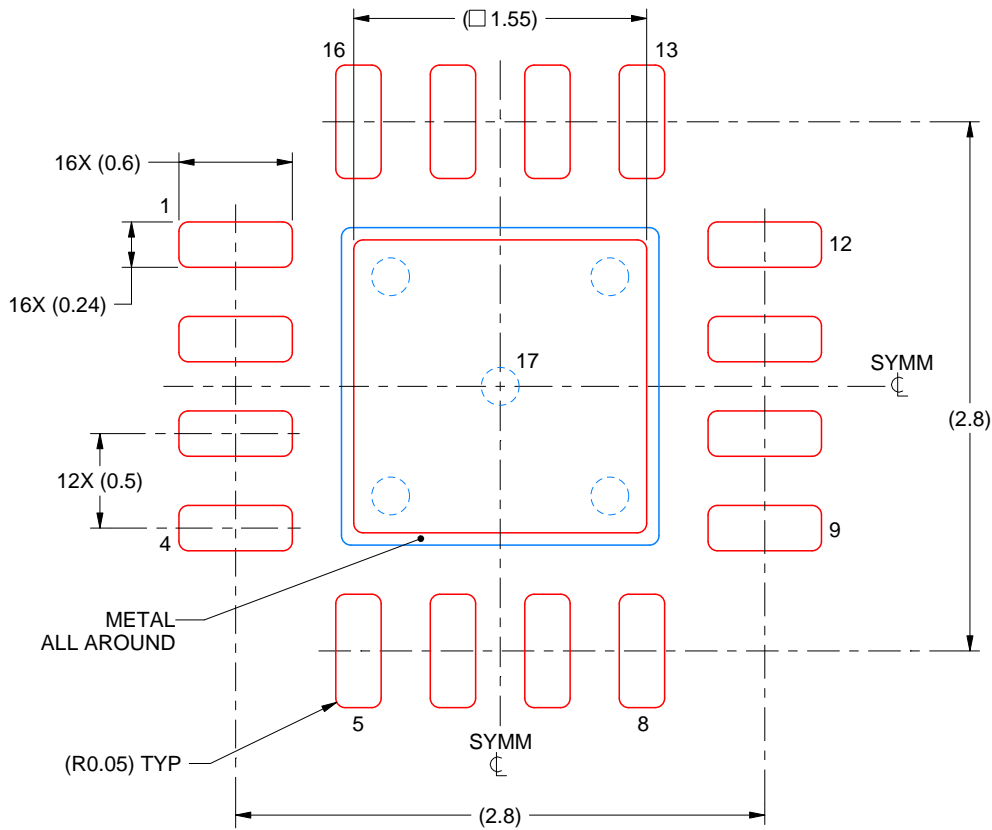

SOLDER PASTE EXAMPLE
BASED ON 0.125 mm THICK STENCIL

EXPOSED PAD 17:
85% PRINTED SOLDER COVERAGE BY AREA UNDER PACKAGE
SCALE:25X

4222419/D 04/2022

NOTES: (continued)

6. Laser cutting apertures with trapezoidal walls and rounded corners may offer better paste release. IPC-7525 may have alternate design recommendations.

IMPORTANT NOTICE AND DISCLAIMER

TI PROVIDES TECHNICAL AND RELIABILITY DATA (INCLUDING DATA SHEETS), DESIGN RESOURCES (INCLUDING REFERENCE DESIGNS), APPLICATION OR OTHER DESIGN ADVICE, WEB TOOLS, SAFETY INFORMATION, AND OTHER RESOURCES "AS IS" AND WITH ALL FAULTS, AND DISCLAIMS ALL WARRANTIES, EXPRESS AND IMPLIED, INCLUDING WITHOUT LIMITATION ANY IMPLIED WARRANTIES OF MERCHANTABILITY, FITNESS FOR A PARTICULAR PURPOSE OR NON-INFRINGEMENT OF THIRD PARTY INTELLECTUAL PROPERTY RIGHTS.

These resources are intended for skilled developers designing with TI products. You are solely responsible for (1) selecting the appropriate TI products for your application, (2) designing, validating and testing your application, and (3) ensuring your application meets applicable standards, and any other safety, security, regulatory or other requirements.

These resources are subject to change without notice. TI grants you permission to use these resources only for development of an application that uses the TI products described in the resource. Other reproduction and display of these resources is prohibited. No license is granted to any other TI intellectual property right or to any third party intellectual property right. TI disclaims responsibility for, and you will fully indemnify TI and its representatives against, any claims, damages, costs, losses, and liabilities arising out of your use of these resources.

TI's products are provided subject to [TI's Terms of Sale](#) or other applicable terms available either on [ti.com](https://www.ti.com) or provided in conjunction with such TI products. TI's provision of these resources does not expand or otherwise alter TI's applicable warranties or warranty disclaimers for TI products.

TI objects to and rejects any additional or different terms you may have proposed.

Mailing Address: Texas Instruments, Post Office Box 655303, Dallas, Texas 75265
Copyright © 2024, Texas Instruments Incorporated