

TPS61379-Q1 25- μ A Quiescent Current Synchronous Boost Converter with Load Disconnect

1 Features

- AEC-Q100 qualified for automotive applications
 - Device temperature grade 1: -40°C to 125°C ambient operating temperature range
- [Function Safety-Capable](#)
 - [Documentation available to aid functional safety system design](#)
- Flexible input and output operation range
 - Input voltage range: 2.3 V to 14 V
 - Programmable output voltage range: 4.0 V to 18.5 V
 - [5-V, 5.25-V, 5.5-V fixed output options](#)
 - Fixed 2-A peak current limit
- Avoid AM band interference and crosstalk
 - Dynamically programmable switching frequency: 200 kHz to 2.2 MHz
 - Spread spectrum frequency modulation
 - Optional clock synchronization
- Minimize solution size for space constraint applications
 - Integrated LS/HS/ISO FET: $R_{DS(ON)}$ 50 m Ω /50 m Ω /100 m Ω
 - Support up to 2.2 MHz with small L-C
- Minimized light load and idle state current consumption
 - 25- μ A quiescent current into VIN pin
 - 0.5- μ A shutdown current into VIN pin
 - Selectable auto PFM and forced PWM mode
 - True load disconnect during shutdown or fault conditions
- Integrated protection features
 - Support VIN close to VOUT operation
 - Input undervoltage lockout and output overvoltage protection
 - Hiccup output short circuit protection
 - Power good indicator
 - Thermal shutdown protection at 165°C
- Higher than 90% efficiency under 0.25-A load from 3.3-V to 9-V conversion

2 Applications

- [Advanced driver-assistance system \(ADAS\)](#)
- [Automotive infotainment and cluster](#)
- [Body electronics and lighting](#)
- [Emergency call \(eCall\)](#)

3 Description

The TPS61379-Q1 is a fully integrated synchronous boost converter with load disconnect function integrated. The input voltage covers 2.3 V to 14 V, while the maximal output voltage is up to 18.5 V. The switching current limit is 2 A typical. It consumes 25- μ A quiescent current from V_{IN} .

The TPS61379-Q1 employs the peak current mode control with the switching frequency programmable from 200 kHz to 2.2 MHz. The device works in fixed frequency PWM operation in medium to heavy load. There are two optional modes in light load by configuring the MODE pin: auto PFM mode and forced PWM to balance the efficiency and noise immunity in light load. The switching frequency can be synchronized to an external clock. The TPS61379-Q1 uses the spread spectrum of the internal clock to be more EMI friendly at FPWM mode. In addition, there is an internal soft-start time to limit the inrush current.

The TPS61379-Q1 has various fixed output voltage versions to save the external feedback resistor. It supports the external loop compensation so that the stability and transient response can be optimized at wider V_{OUT}/V_{IN} ranges. It also integrates robust protection features including the output short protection, output overvoltage protection, and thermal shutdown protection. The TPS61379-Q1 is available in a 3-mm \times 3-mm 16-pin QFN package with wettable flank.

Device Information

PART NUMBER	PACKAGE ⁽¹⁾	BODY SIZE (NOM)
TPS61379-Q1	VQFN-16	3.0-mm \times 3.0-mm

(1) For all available packages, see the orderable addendum at the end of the data sheet.

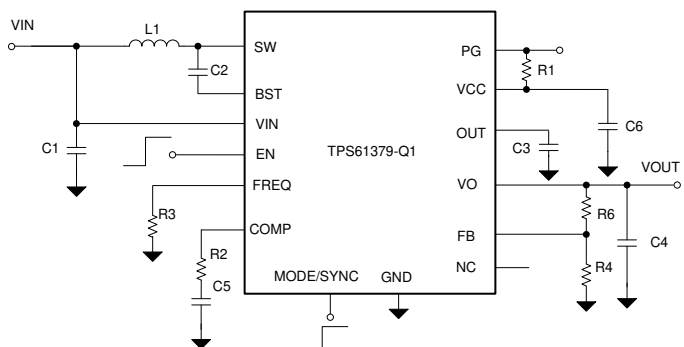

Typical Application



Table of Contents

1 Features	1	8.4 Device Functional Modes.....	13
2 Applications	1	9 Application and Implementation	15
3 Description	1	9.1 Application Information.....	15
4 Revision History	2	9.2 Typical Application.....	15
5 Device Comparison Table	3	10 Power Supply Recommendations	24
6 Pin Configuration and Functions	4	11 Layout	25
7 Specifications	5	11.1 Layout Guidelines.....	25
7.1 Absolute Maximum Ratings	5	11.2 Layout Example.....	25
7.2 ESD Ratings	5	12 Device and Documentation Support	26
7.3 Recommended Operating Conditions	5	12.1 Device Support.....	26
7.4 Thermal Information	5	12.2 Receiving Notification of Documentation Updates.....	26
7.5 Electrical Characteristics	6	12.3 Support Resources.....	26
7.6 Typical Characteristics.....	8	12.4 Trademarks.....	26
8 Detailed Description	10	12.5 Glossary.....	26
8.1 Overview.....	10	12.6 Electrostatic Discharge Caution.....	26
8.2 Functional Block Diagrams.....	11	13 Mechanical, Packaging, and Orderable Information	26
8.3 Feature Description.....	11		

4 Revision History

Changes from Revision A (June 2021) to Revision B (October 2021)	Page
• Replaced the operating ambient temperature with the operating junction temperature and added table note in Section 7.3	5
• Updated Section 8.3.12	13
• Updated Figure 9-2	19

Changes from Revision * (March 2021) to Revision A (June 2021)	Page
• Updated resistor from FB to GND values.....	3
• Updated voltage reference specifications.....	6
• Updated Section 9.2.2.1	15

5 Device Comparison Table

PART NUMBER	OUTPUT VOLTAGE (V)	RESISTOR FROM FB TO GND (R_{FB_LOW})	SPREAD SPECTRUM
TPS61379-Q1	5	$0\Omega \leq R_{FB_LOW} \leq 2.4\text{ k}\Omega$	Enable
	5.25	$3.6\text{ k}\Omega \leq R_{FB_LOW} \leq 4.8\text{ k}\Omega$	
	5.5	$7.2\text{ k}\Omega \leq R_{FB_LOW} \leq 9.6\text{ k}\Omega$	
	Adjustable	$14.4\text{ k}\Omega \leq R_{FB_LOW} \leq 100\text{ k}\Omega$	

6 Pin Configuration and Functions

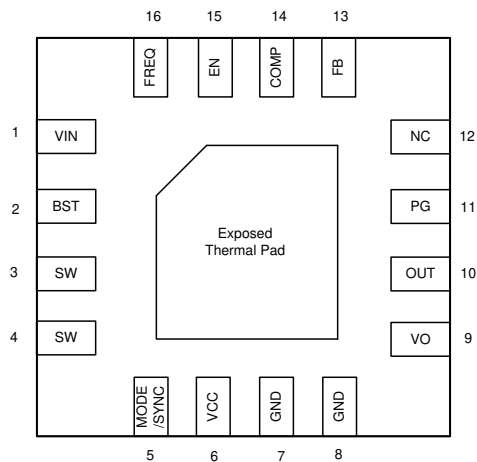

Figure 6-1. 16-Pin WQFN RTE Package (Transparent Top View)

Table 6-1. Pin Functions

PIN		I/O	DESCRIPTION
NAME	NO.		
VIN	1	I	IC power supply input
BST	2	I	Power supply for high-side N-MOSFET gate drivers. A capacitor must be connected between this pin and SW pin.
SW	3, 4	PWR	The switching node pin of the converter. It is connected to the drain of the internal low-side FET and the source of the high-side FET.
MODE/SYNC	5	I	Mode selection pin. MODE = high, forced PWM mode. MODE = low or floating, auto PFM mode. This pin can also be used to synchronize the external clock. Refer to Table 8-1 for details.
VCC	6	O	Output of internal regulator. A ceramic capacitor with more than 1 μ F must be connected between this pin and GND.
GND	7, 8	PWR	Power ground of the IC. It is connected to the source of the low-side FET.
VO	9	PWR	Output of the isolation FET. Connect load to this pin to achieve input/output isolation.
OUT	10	PWR	Output of the drain of the HS FET. Connect this pin as the output can disable the load disconnect/short protection feature (or short this pin with VO pin).
PG	11	O	Power good indicator, open-drain output
NC	12	I	No connection pin
FB	13	I	Feedback pin. Use a resistor divider to set the desired output voltage. Refer to Section 9.2.2.1 for details.
COMP	14	I	Output of the internal transconductance error amplifier. An external RC network is connected to this pin to optimize the loop stability and response time.
EN	15	I	Enable logic input
FREQ	16	I	Frequency setting pin. Connect a resistor between this pin and GND pin to set the desired frequency.
Thermal Pad	-	-	The thermal pad must be connected to power ground plane for good power dissipation.

7 Specifications

7.1 Absolute Maximum Ratings

over operating free-air temperature range (unless otherwise noted)⁽¹⁾

		MIN	MAX	UNIT
Voltage range at terminals ⁽²⁾	VIN	-0.3	16	V
Voltage range at terminals ⁽²⁾	VO, SW, OUT	-0.3	23	V
	BST	-0.3	SW + 6	V
	MODE/SYNC, FB, FREQ, ILIM, VCC, COMP, EN	-0.3	6	V
	PG	-0.3	20	V
T _J ⁽³⁾	Operating junction temperature	-40	150	°C
T _{stg}	Storage temperature	-65	150	°C

- (1) Operation outside the *Absolute Maximum Ratings* may cause permanent device damage. *Absolute Maximum Ratings* do not imply functional operation of the device at these or any other conditions beyond those listed under *Recommended Operating Conditions*. If used outside the *Recommended Operating Conditions* but within the *Absolute Maximum Ratings*, the device may not be fully functional, and this may affect device reliability, functionality, performance, and shorten the device lifetime.
- (2) All voltage values are with respect to network ground terminal.
- (3) High junction temperatures degrade operating lifetime. Operating lifetime is de-rated for junction temperatures greater than 125°C

7.2 ESD Ratings

			VALUE	UNIT	
V _(ESD) ⁽¹⁾	Electrostatic discharge	Human-body model (HBM), per AEC Q100-002 ⁽²⁾	±2000	V	
		Charged-device model (CDM), per AEC Q100-011 ⁽³⁾	All pins		±500
			Corner pins (1, 4, 5, 8, 9, 12, 13, and 16)		±750

- (1) Electrostatic discharge (ESD) to measure device sensitivity and immunity to damage caused by assembly line electrostatic discharges in to the device.
- (2) Level listed above is the passing level per ANSI, ESDA, and JEDEC JS-001. JEDEC document JEP155 states that 500-V HBM allows safe manufacturing with a standard ESD control process. Manufacturing with less than 500-V HBM is possible with the necessary precautions.
- (3) Level listed above is the passing level per EIA-JEDEC JESD22-C101. JEDEC document JEP157 states that 250-V CDM allows safe manufacturing with a standard ESD control process. Manufacturing with less than 250-V CDM is possible with the necessary precautions.

7.3 Recommended Operating Conditions

over operating free-air temperature range (unless otherwise noted)

		MIN	NOM	MAX	UNIT
V _{IN}	Input voltage	2.3		14	V
V _{OUT}	Output voltage	4		18.5	V
T _J	Operating junction temperature ⁽¹⁾	-40		150	°C

- (1) High junction temperatures degrade operating lifetimes. Operating lifetime is de-rated for junction temperatures greater than 125°C.

7.4 Thermal Information

THERMAL METRIC ⁽¹⁾		TPS61379-Q1	UNIT
		RTE	
		16 PINS	
R _{θJA}	Junction-to-ambient thermal resistance	46.2	°C/W
R _{θJC(top)}	Junction-to-case (top) thermal resistance	43.5	°C/W
R _{θJB}	Junction-to-board thermal resistance	18.5	°C/W
ψ _{JT}	Junction-to-top characterization parameter	1.1	°C/W
ψ _{JB}	Junction-to-board characterization parameter	18.5	°C/W

7.4 Thermal Information (continued)

THERMAL METRIC ⁽¹⁾		TPS61379-Q1		UNIT
		RTE		
		16 PINS		
R _{θJC(bot)}	Junction-to-case (bottom) thermal resistance	8.8		°C/W

(1) For more information about traditional and new thermal metrics, see the *Semiconductor and IC Package Thermal Metrics* application report, [SPRA953](#).

7.5 Electrical Characteristics

T_J = -40 to 125°C, L = 1 μH, V_{IN} = 3.3 V and V_{OUT} = 9 V (VO pin). Typical values are at T_J = 25°C, (unless otherwise noted)

PARAMETER		TEST CONDITIONS	MIN	TYP	MAX	UNIT
POWER SUPPLY						
V _{IN}	Input voltage range		2.3		14	V
V _{IN_UVLO}	VIN under voltage lockout threshold	V _{IN} rising		2.2	2.3	V
		V _{IN} falling		2.04	2.2	V
V _{IN_HYS}	VIN UVLO hysteresis			160		mV
V _{CC_UVLO}	VCC UVLO threshold	V _{CC} rising		2.2		V
V _{CC_HYS}	VCC UVLO hysteresis	V _{CC} hysteresis		150		mV
V _{CC}	VCC regulation	I _{VCC} = 6 mA, V _{OUT} = 9V		4.8		V
I _Q	Quiescent current into V _{IN} pin	IC enabled, no load, V _{IN} = 3.3 V, V _{OUT} = 18.5 V, V _{FB} = V _{REF} + 0.1 V		25	35	μA
I _Q	Quiescent current into OUT pin	IC enabled, no load, V _{IN} = 3.3 V, V _{OUT} = 18.5 V, V _{FB} = V _{REF} + 0.1 V		10	20	μA
I _{SD}	Shutdown current into VIN pin	IC disabled, V _{IN} = 14 V, EN = GND		0.6	5	μA
I _{SW_LKG}	Leakage current into SW	IC disabled, V _{IN} = OUT = SW = 14 V			5	μA
I _{VO_LKG}	Reverse leakage current into VO	IC disabled, OUT = VO = 5 V, SW = 0			5	μA
OUTPUT VOLTAGE						
V _{OVP}	Output over-voltage protection threshold	V _{IN} = 3.3 V, V _{OUT} rising	19.3	20	20.5	V
V _{OVP_HYS}	Output over-voltage protection hysteresis	V _{IN} = 3.3 V, OVP threshold		0.5		V
VOLTAGE REFERENCE						
V _{REF}	Reference Voltage at FB pin	T _J = -40 to 125°C, R _{FB} = 16.0 kΩ	0.788	0.800	0.812	V
V _{OUT_5V}		T _J = -40 to 125°C, R _{FB} = 2.0 kΩ	4.85	5.00	5.15	V
V _{OUT_5.25V}		T _J = -40 to 125°C, R _{FB} = 4.0 kΩ	5.10	5.25	5.35	V
V _{OUT_5.5V}		T _J = -40 to 125°C, R _{FB} = 8.0 kΩ	5.35	5.50	5.65	V
I _{FB_LKG}	Leakage current into FB pin				50	nA
POWER SWITCH						
R _{DS(on)}	Low-side MOSFET on resistance	V _{CC} = 4.85 V		50		mΩ
R _{DS(on)}	High-side MOSFET on resistance	V _{CC} = 4.85 V		50		mΩ
R _{DS(on)}	Isolation MOSFET on resistance	V _{CC} = 4.85 V		100		mΩ
CURRENT LIMIT						
I _{LIM_SW}	Peak switching current limit Auto PFM	Duty cycle = 65%	1.58	2	2.25	A
I _{LIM_SW}	Peak switching current limit FPWM	Duty cycle = 65%	1.58	2	2.25	A
SWITCHING FREQUENCY						
F _{sw}	Switching frequency	R _{FREQ} = 18 kΩ	2050	2200	2400	kHz
F _{sw}	Switching frequency	R _{FREQ} = 218 kΩ	180	200	230	kHz
D _{max}	Maximum Duty Cycle	R _{FREQ} = 18 kΩ	78			%
t _{ON_min}	Minimal on time			70		ns
F _{DITHER}				10%		F _{sw}
F _{pattern}				0.4%		F _{sw}
ERROR AMPLIFIER						

7.5 Electrical Characteristics (continued)

$T_J = -40$ to 125°C , $L = 1\ \mu\text{H}$, $V_{\text{IN}} = 3.3\ \text{V}$ and $V_{\text{OUT}} = 9\ \text{V}$ (VO pin). Typical values are at $T_J = 25^\circ\text{C}$, (unless otherwise noted)

PARAMETER		TEST CONDITIONS	MIN	TYP	MAX	UNIT
I_{SINK}	COMP pin sink current	$V_{\text{FB}} = V_{\text{REF}} + 0.2\text{V}$		6		μA
I_{SOURCE}	COMP pin source current	$V_{\text{FB}} = V_{\text{REF}} - 0.2\text{V}$		6		μA
V_{CCLPH}	COMP pin high clamp voltage	$V_{\text{FB}} = V_{\text{REF}} - 0.2\ \text{V}$, $I_{\text{LIM}} = 2\ \text{A}$		1		V
V_{CCLPL}	COMP pin low clamp voltage	$V_{\text{FB}} = V_{\text{REF}} + 0.2\ \text{V}$,		0.6		V
G_{mEA}	Error amplifier trans conductance	$V_{\text{COMP}} = 1.0\ \text{V}$		70		μS
POWER GOOD						
$V_{\text{PG_TH}}$	PG threshold for rising FB voltage	Reference to V_{REF}		90%		
$V_{\text{PG_HYS}}$	PG hysteresis	Reference to V_{REF}		5%		
$I_{\text{PG_SINK}}$	PG pin sink current capability	$V_{\text{PG}} = 0.4\ \text{V}$		20		mA
$t_{\text{PG_DELAY}}$	PG delay time		2.5	3.4	4.3	ms
DOWN MODE						
$t_{\text{EN_DELAY}}$	Delay time between EN high and device working			0.4		ms
t_{SS}	Softstart time			2.5		ms
$t_{\text{HCP_ON}}$	Hiccup on time			1.8		ms
$t_{\text{HCP_OFF}}$	Hiccup off time			67		ms
SYNC TIMING						
$f_{\text{SYNC_MIN}}$				200		kHz
$f_{\text{SYNC_MAX}}$				2200		kHz
EN/SYNC LOGIC						
V_{IH}	EN, MODE/SYNC pins Logic high threshold				1.2	V
V_{IL}	EN, MODE/SYNC pins Logic Low threshold		0.4			V
R_{DOWN}	EN, MODE/SYNC pins internal pull down resistor			800		k Ω
THERMAL SHUTDOWN						
$t_{\text{SD_R}}$	Thermal shutdown rising threshold	T_J rising		165		$^\circ\text{C}$
$t_{\text{SD_F}}$	Thermal shutdown falling threshold	T_J falling		145		$^\circ\text{C}$

7.6 Typical Characteristics

$V_{IN} = 3.3\text{ V}$, $V_{OUT} = 9\text{ V}$ (VO pin), $T_A = 25^\circ\text{C}$, $F_{sw} = 2.2\text{ MHz}$, unless otherwise noted.

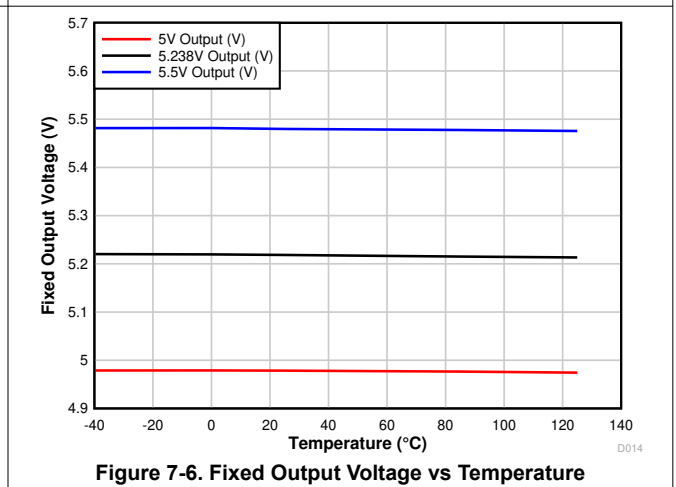
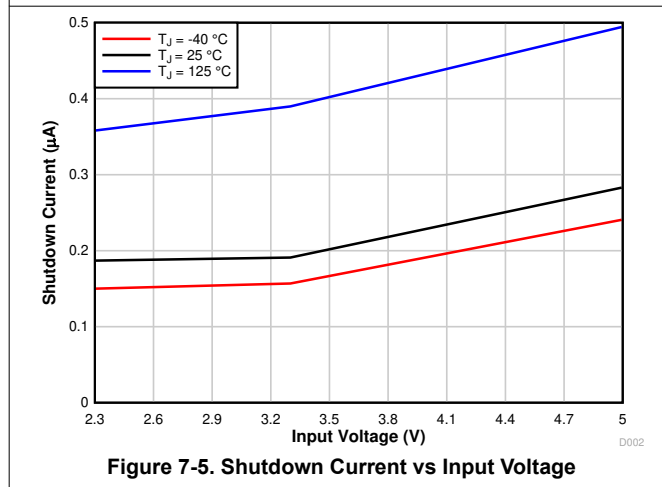
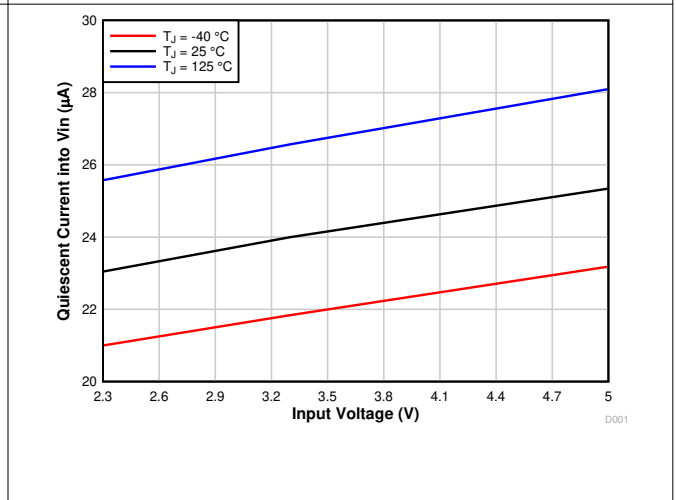
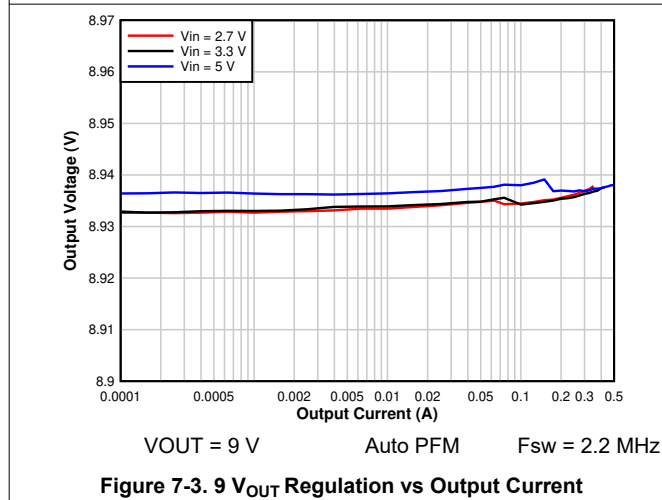
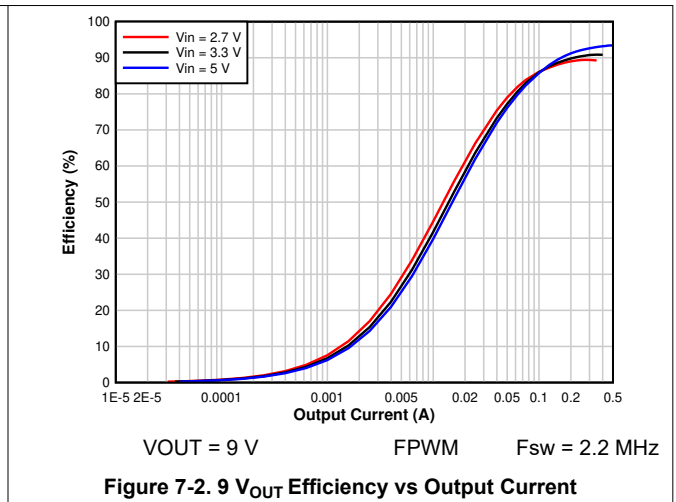
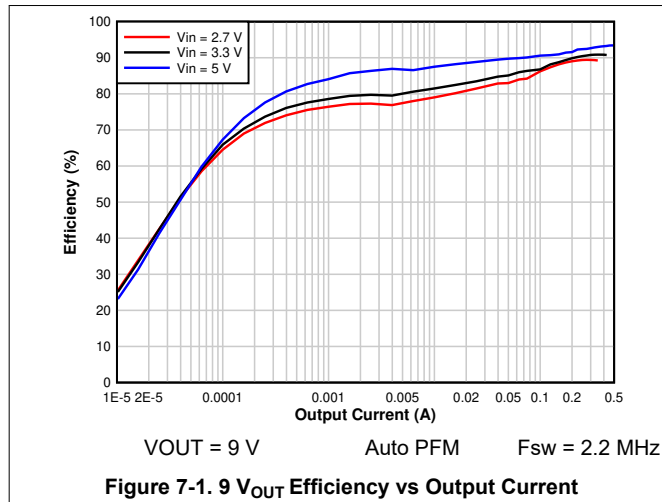

7.6 Typical Characteristics (continued)

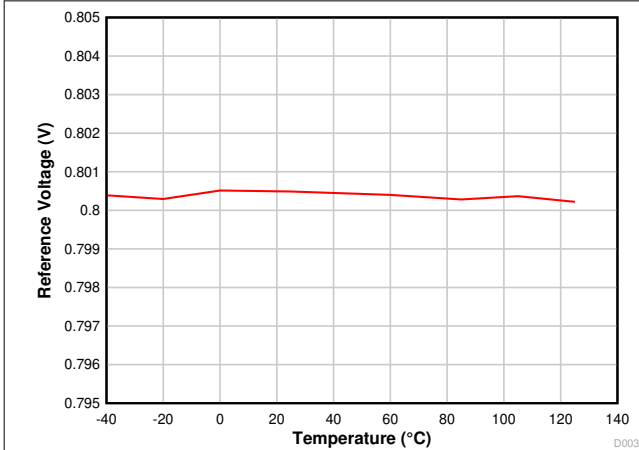

Figure 7-7. Reference Voltage vs Temperature

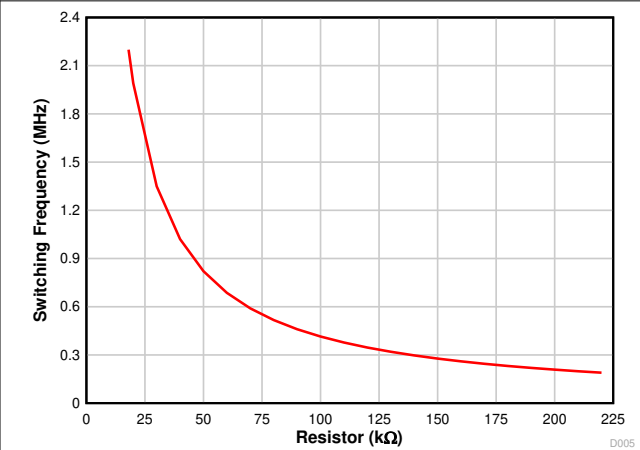

Figure 7-8. Switching Frequency vs Setting Resistance

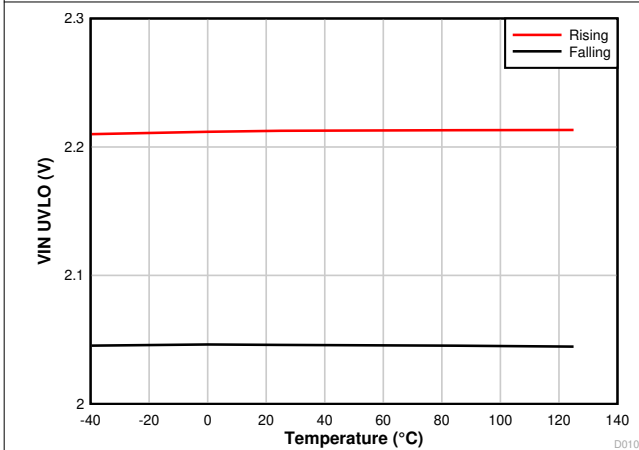

Figure 7-9. V_{IN} UVLO Threshold Voltage vs Temperature

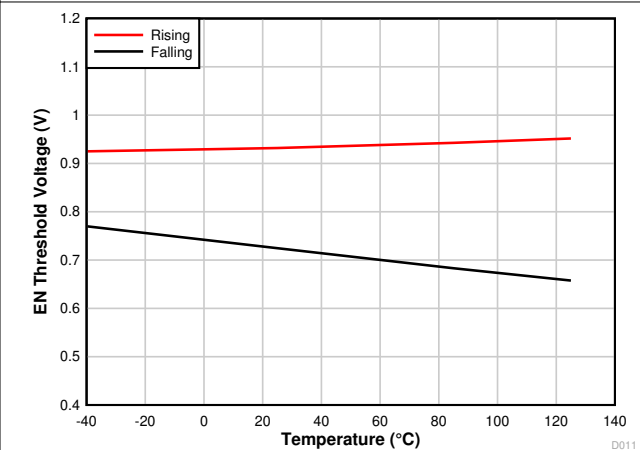

Figure 7-10. EN Threshold Voltage vs Temperature

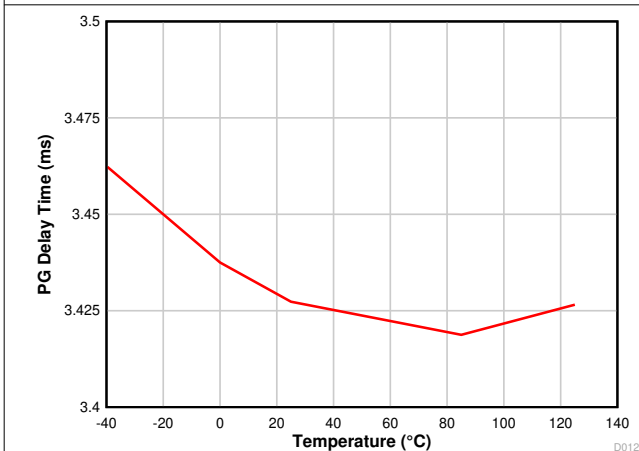

Figure 7-11. PG Delay Time vs Temperature

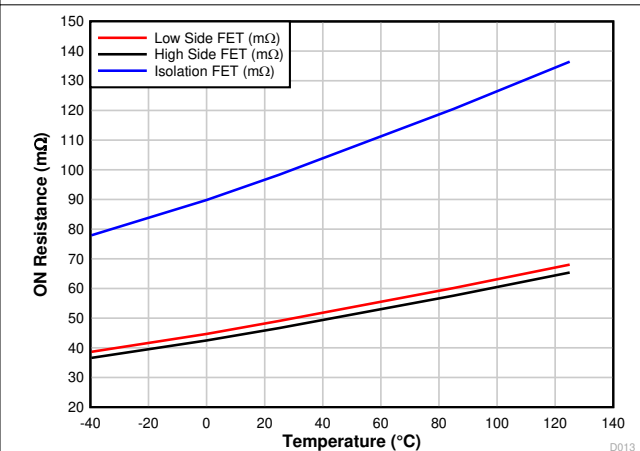

Figure 7-12. $R_{DS(on)}$ vs Temperature

8 Detailed Description

8.1 Overview

The TPS61379-Q1 is a fully integrated synchronous boost converter with load disconnect function. It supports output voltage up to 18.5 V with a maximum 2-A fixed switching peak current limit. The input voltage ranges from 2.3 V to 14 V while consuming 25- μ A quiescent current.

The device utilizes the fixed frequency peak current control scheme, which has an internal oscillator and supports adjustable switching frequency from 200 kHz to 2.2 MHz.

The device operates with fixed frequency pulse width modulation (PWM) from medium to heavy load. At the beginning of each switching cycle, the low-side N-MOSFET switch is turned on, and the inductor current ramps up to a peak current that is determined by the output of the internal error amplifier (EA). Once the switching peak current triggers the output of the EA, the low-side N-MOSFET is turned off and the high-side N-MOSFET is turned on after a short dead time. The high-side N-MOSFET switch is not turned off until the next cycle as determined by the internal oscillator. The low-side switch turns on again after a short dead time and the switching cycle is repeated.

The TPS61379-Q1 provides either Auto PFM or Forced PWM option for light load operation by configuring the MODE/SYNC pin. In Forced PWM mode, the switching frequency remains constant across the entire load range, which helps avoid the frequency variation with load. The internal oscillator can be synchronized to an external clock applied on the MODE / SYNC pin. Spread spectrum modulation of the frequency in Forced PWM mode helps optimize the EMI performance for automotive applications. In Auto PFM mode, the switching frequency can decrease, resulting in higher efficiency.

The device implements a cycle-by-cycle current limit to protect the device from overload during the boost operation phase. If the output current further increases and triggers the output voltage to fall below the input voltage, the TPS61379-Q1 enters into hiccup mode short protection.

There is a built-in soft-start time that prevents the inrush current during the start-up. The TPS61379-Q1 also provides a power good (PG) indicator to enable the power sequence control for start-up.

The TPS61379-Q1 also has a number of protection features including output short protection, output overvoltage protection (OVP), and thermal shutdown protection (OTP).

8.2 Functional Block Diagrams

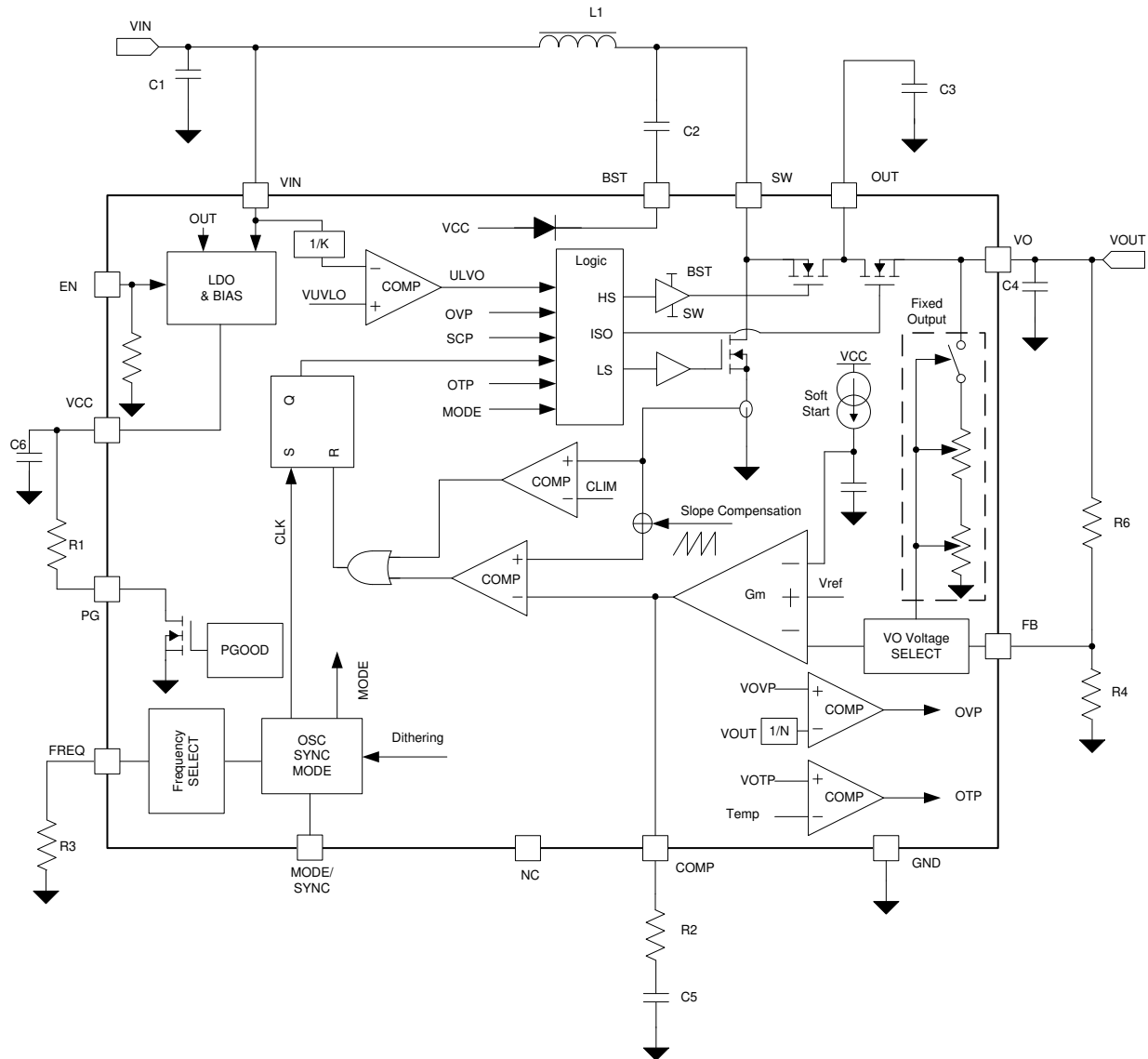

8.3 Feature Description

8.3.1 VCC Power Supply

The internal LDO in the TPS61379-Q1 outputs a regulated voltage of 4.8 V with 10-mA output current capability. A ceramic capacitor is connected between the VCC pin and GND pin to stabilize the VCC voltage and also decouple the noise on the VCC pin. The value of this ceramic capacitor must be above 1 μ F. A ceramic capacitor with an X7R or X5R grade dielectric with a voltage rating higher than 10 V is recommended.

8.3.2 Input Undervoltage Lockout (UVLO)

An undervoltage lockout (UVLO) circuit stops the operation of the converter when the input voltage drops below the UVLO threshold of 2.04 V (typical). A hysteresis of 160 mV (typical) is added so that the device cannot be enabled again until the input voltage exceeds 2.2 V (typical). This function is implemented to prevent malfunctioning of the device when the input voltage is between 2.04 V and 2.2 V.

8.3.3 Enable and Soft Start

When the input voltage is above the UVLO threshold and the EN pin is pulled above 1.2 V, the TPS61379-Q1 is enabled. The TPS61379-Q1 starts to monitor the FB pin. With a typical 400- μ s delay time after EN is pulled high,

the TPS61379-Q1 starts switching. There is an internal built-in start-up time, which is typically 2.5 ms, to limit the inrush current during start-up.

8.3.4 Shut Down

When the input voltage is below the UVLO threshold or the EN pin is pulled low, the TPS61379-Q1 is in shutdown mode and all the functions are disabled. The input voltage is isolated from the output to minimize the leakage currents.

8.3.5 Switching Frequency Setting

The TPS61379-Q1 uses a fixed frequency control scheme. The switching frequency can be programmed between 200 kHz and 2.2 MHz using a resistor from the FREQ pin to GND. The resistor must be connected when the oscillator is synchronized by an external clock. The resistance is defined by [Equation 1](#).

$$F_{SW}(\text{MHz}) = \frac{41.9}{R_{FREQ}(\text{k}\Omega) + 1.05} \quad (1)$$

where

- R_{FREQ} is the resistance between the FREQ pin and the GND pin

For instance, the switching frequency is 2.2 MHz if the resistance between the FREQ pin and GND is 18 k Ω . This pin cannot be left floating or tied to VCC.

8.3.6 Spread Spectrum Frequency Modulation

The TPS61379-Q1 uses a triangle waveform to spread the switching frequency with $\pm 10\%$ of normal frequency. The frequency of the triangle waveform is typically 0.4% of the switching frequency. For example, if the normal switching frequency of TPS61379-Q1 is programmed to 2.2 MHz, the spread spectrum function modulates the switching frequency in the range of 1.98 MHz to 2.42 MHz in a triangle behavior with 8.8 kHz rate.

The spread spectrum is only available while the clock of the TPS61379-Q1 is free running at its natural frequency. Any of the following conditions overrides spread spectrum, turning it off:

- An external clock is applied to the MODE/SYNC pin.
- The device works in the PFM operation at light load.

8.3.7 Bootstrap

The TPS61379-Q1 has an integrated bootstrap regulator circuit. A small ceramic capacitor is needed between the BST pin and SW pin to provide the gate drive supply voltage for the high-side switches. The bootstrap capacitor is charged during the time when the low-side switch is in the ON state. The value of this ceramic capacitor must be above 0.1 μF . A ceramic capacitor with an X7R or X5R grade dielectric with a voltage rating higher than 6.3 V is recommended.

8.3.8 Load Disconnect

The TPS61379-Q1 integrates a load disconnect function when the input source is DC, which completely cuts off the path between the input side and the output side during shutdown.

The output disconnect function also allows the output short protection and minimize the inrush current at start-up.

8.3.9 MODE/SYNC Configuration

[Table 8-1](#) summarizes the MODE/SYNC function and the entry condition.

Table 8-1. MODE/SYNC Configuration

MODE/SYNC PIN CONFIGURATION	MODE
Logic Low or Floating	Auto PFM Mode
Logic High	Forced PWM Mode
External Synchronization	Forced PWM Mode

The TPS61379-Q1 can be synchronized to an external clock applied to the MODE / SYNC pin.

8.3.10 Overvoltage Protection (OVP)

If the output voltage exceeds the OVP threshold (typical 20 V), the TPS61379-Q1 stops switching immediately until the output voltage drops below the recovery threshold (typical 19.5 V). This function protects the device against excessive voltage.

8.3.11 Output Short Protection/Hiccup

In addition to the cycle-by-cycle current limit function, the TPS61379-Q1 also has output short protection. If the output current causes low-side FET to reach current limit and pull the output voltage below the input voltage, the device enters into short circuit protection mode which triggers the hiccup timer. When the hiccup timer is triggered, the device limits the current to a relative lower level for 1.8 ms, and then shuts down. After 67 ms, it restarts. If the short condition disappears, the device automatically restarts.

When FB voltage is below ≤ 0.1 V during fault condition, the current limit threshold is reduced to 1/5 of the programmed current limit, and frequency is clamped to 1.1 MHz if the FREQ pin setting is greater than 1.1 MHz and VIN and VO voltage delta is greater than 6 V.

8.3.12 Power-Good Indicator

The TPS61379-Q1 integrates a power-good function. The power-good output consists of an open-drain NMOS, requiring an external pullup resistor connect to a suitable voltage supply like VCC. The PG pin goes high with a typical 3.4-ms delay time after VOUT reaches 90% of the target output voltage. When the output voltage drops below 85% of the target output voltage, the PG pin immediately goes low without delay.

8.3.13 Thermal Shutdown

A thermal shutdown is implemented to prevent damage due to the excessive heat and power dissipation. Typically, the thermal shutdown occurs at the junction temperature exceeding 165°C. When the thermal shutdown is triggered, the device stops switching and recovers when the junction temperature falls below 145°C (typical).

8.4 Device Functional Modes

8.4.1 Forced PWM Mode

The TPS61379-Q1 enters forced PWM mode by pulling the MODE/SYNC pin to logic high for more than five switching cycles. In forced PWM mode, the TPS61379-Q1 keeps the switching frequency constant at light load condition. When the load current decreases, the output of the internal error amplifier also decreases to keep the inductor peak current down. When the output current decreases further, the high-side switch is not turned off even if the current of the high-side switch goes negative to keep the frequency constant.

8.4.2 Auto PFM Mode

The TPS61379-Q1 enters auto PFM mode by pulling the MODE/SYNC pin to logic low for more than five switching cycles or leave the pin floating. The TPS61379-Q1 improves the efficiency at light load when operating in PFM mode. When the output current decreases to a certain level, the output voltage of the error amplifier is clamped by the internal circuit. If the output current reduces further, the inductor current through the high-side switch is clamped but not further lowered. Pulses are skipped to improve the efficiency at light load.

8.4.3 External Clock Synchronization

The TPS61379-Q1 supports external clock synchronization with a range of 200 kHz to 2.2 MHz. The TPS61379-Q1 remains in the forced PWM mode and operates in CCM across the entire load range if the oscillator is synchronized by an external clock. Spread spectrum feature is disabled when external synchronization is used.

8.4.4 Down Mode

The TPS61379-Q1 features Down mode operation when input voltage is close to or higher than output voltage. In Down mode, output voltage is regulated at target value even when $V_{IN} > V_O$. The high-side and low-side FETs of the TPS61379-Q1 are switching devices that always work in boost operation, where the isolation FET always works as a linear device.

For boost circuits, on time or duty cycle is reduced as input voltage approaches output voltage. The TPS61379-Q1 enters Down mode when V_{IN} reaches 85% (typical) of V_O voltage at 2.2 MHz; while exiting Down mode requires V_{IN} to be reduced below 85% (typical) of V_O voltage at 2.2 MHz.

In normal operation, isolation FET is fully on.

When Down mode is triggered and V_{IN} is less than V_O pin voltage, the OUT pin has a fixed 2 V (typical) above V_O pin voltage. Isolation FET works in LDO mode to regulate V_O pin voltage with a 2-V constant voltage drop.

When Down mode is triggered and V_{IN} is 100 mV (typical) higher than V_O pin voltage, the OUT pin has an approximated 3 V (typical) above V_{IN} pin voltage, as V_{IN} keeps rising, the OUT pin continues to raise with 3 V on top of V_{IN} , isolation FET works in LDO mode to regulate V_O pin voltage with a voltage differential of OUT pin and V_O pin.

Refer to [Figure 8-1](#).

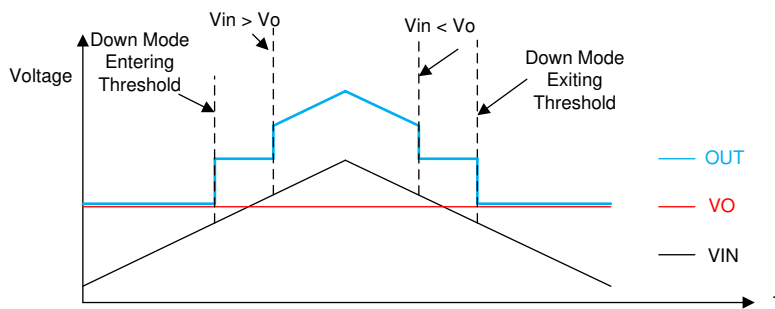

Figure 8-1. Down Mode

Care should be taken during short-to-ground condition when operation V_{IN} is above 6 V. During hiccup on, the device operates in Down mode and isolation FET voltage drop is $V_{IN} + 3$ V (OUT pin to V_O pin).

9 Application and Implementation

Note

Information in the following applications sections is not part of the TI component specification, and TI does not warrant its accuracy or completeness. TI's customers are responsible for determining suitability of components for their purposes, as well as validating and testing their design implementation to confirm system functionality.

9.1 Application Information

The TPS61379-Q1 is a 25- μ A quiescent current boost converter that supports 2.3-V to 14-V input voltage range. It also supports load disconnect to minimize the leakage current. The following design procedure can be used to select component values for the TPS61379-Q1.

9.2 Typical Application

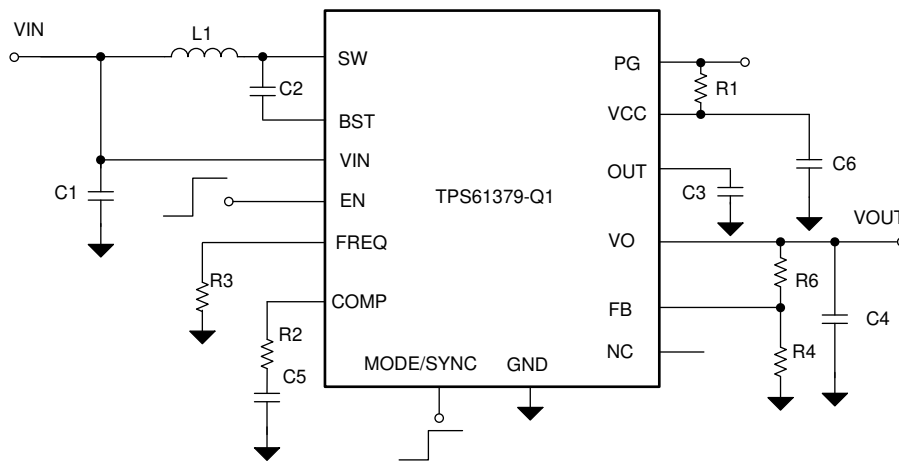

Figure 9-1. Typical Application

9.2.1 Design Requirements

A typical application example is dual cameras powered through a coax cable, which normally requires 9.0-V output as its bias voltage and consumes less than 200-mA current per camera. 250-mA load current is designed to provide margin. The following design procedure can be used to select external component values for the TPS61379-Q1.

Table 9-1. Design Requirements

PARAMETERS	VALUES
Input voltage	3.3 V to 6.4 V
Output voltage	9.0 V
Switching frequency	2.2 MHz
Output current	250 mA
Output voltage ripple	± 25 mV

9.2.2 Detailed Design Procedure

9.2.2.1 Programming the Output Voltage

There are two ways to set the output voltage of the TPS61379-Q1: adjustable or fixed. If the resistance between FB and GND is higher than 14.4k Ω and less than 100k Ω during start-up, the TPS61379-Q1 works as an adjustable output version. The FB pin is connected to the negative input of the internal error amplifier directly. The output voltage can be programmed by adjusting the external resistor divider R_{Upper} and R_{Lower} according to [Equation 2](#). When the output voltage is in well regulation, the typical voltage at the FB pin is V_{REF} of 0.8 V.

$$V_{OUT} = V_{REF} \times \frac{(R_{Upper} + R_{Lower})}{R_{Lower}} \quad (2)$$

For some applications where the resistor needs to be as low as possible, the low-side divider can be 20 kΩ. The reference voltage is 0.8 V, the high-side divider is 205 kΩ for 9-V output voltage.

For other applications without specific requirements on divider resistance, the user can choose R_{Lower} to be approximately 80.6 kΩ. Slightly increasing or decreasing R_{Lower} can result in closer output voltage matching when using standard values resistors.

For the best accuracy, R_{Lower} is recommended to be smaller than 100 kΩ to ensure that the current following through R_{Lower} is at least 100 times larger than FB pin leakage current. Changing R_{Lower} towards the lower value increases the robustness against noise injection. Changing the R_{Lower} to higher values reduces the quiescent current for achieving higher efficiency at light load.

If the resistance between FB and GND is less than 9.6kΩ during start-up, the TPS61379-Q1 works as a fixed output voltage version. The TPS61379-Q1 uses the internal resistor divider.

For 5-V fixed output voltage, R_{Lower} is between 0Ω and 2.4kΩ and R_{Upper} should be removed.

For 5.25-V fixed output voltage, R_{Lower} is between 3.6kΩ and 4.8 kΩ and R_{Upper} should be removed.

For 5.5-V fixed output voltage, R_{Lower} is between 7.2kΩ and 9.6kΩ and R_{Upper} should be removed.

9.2.2.2 Setting the Switching Frequency

The switching frequency of the TPS61379-Q1 is set at 2.2 MHz. Use [Equation 1](#) to calculate the required resistor value. The calculated value is 18 kΩ to get the frequency of 2.2 MHz.

9.2.2.3 Selecting the Inductor

A boost converter normally requires two main passive components for storing the energy during the power conversion: an inductor and an output capacitor. The inductor affects the steady state efficiency (including the ripple and efficiency) as well as the transient behavior and loop stability, which makes the inductor the most critical component in application.

When selecting the inductor, as well as the inductance, the other important parameters are:

- The maximum current rating (RMS and peak current must be considered)
- The series resistance
- Operating temperature

The TPS61379-Q1 has built-in slope compensation to avoid subharmonic oscillation associated with the current mode control. If the inductor value is too low and makes the inductor peak-to-peak ripple higher than 2 A, the slope compensation may not be adequate, and the loop can be unstable. Therefore, it is recommended to make the peak-to-peak current ripple between 800 mA to 2 A when selecting the inductor.

The inductance can be calculated by [Equation 3](#), [Equation 4](#), and [Equation 5](#):

$$\Delta I_L = \frac{V_{IN} \times D}{L \times f_{SW}} \quad (3)$$

$$\Delta I_{L_R} = \text{Ripple\%} \times \frac{V_{OUT} \times I_{OUT}}{\eta \times V_{IN}} \quad (4)$$

$$L = \frac{1}{\text{Ripple \%}} \times \frac{\eta \times V_{IN}}{V_{OUT} \times I_{OUT}} \times \frac{V_{IN} \times D}{f_{SW}} \quad (5)$$

where

- ΔI_L is the peak-peak inductor current ripple
- V_{IN} is the input voltage

- D is the duty cycle
- L is the inductor
- f_{SW} is the switching frequency
- Ripple % is the ripple ration versus the DC current
- V_{OUT} is the output voltage
- I_{OUT} is the output current
- η is the efficiency

The current flowing through the inductor is the inductor ripple current plus the average input current. During power up, load faults, or transient load conditions, the inductor current can increase above the peak inductor current calculated.

Inductor values can have $\pm 20\%$ or even $\pm 30\%$ tolerance with no current bias. When the inductor current approaches the saturation level, its inductance can decrease 20% to 35% from the value at 0-A bias current depending on how the inductor vendor defines saturation. When selecting an inductor, make sure its rated current, especially the saturation current, is larger than its peak current during the operation.

The inductor peak current varies as a function of the load, the switching frequency, the input and output voltages and it can be calculated by [Equation 6](#) and [Equation 7](#).

$$I_{PEAK} = I_{IN} + \frac{1}{2} \times \Delta I_L \quad (6)$$

where

- I_{PEAK} is the peak current of the inductor
- I_{IN} is the input average current
- ΔI_L is the ripple current of the inductor

The input DC current is determined by the output voltage, the output current can be calculated by:

$$I_{IN} = \frac{V_{OUT} \times I_{OUT}}{V_{IN} \times \eta} \quad (7)$$

where

- I_{IN} is the input current of the inductor
- V_{OUT} is the output voltage
- V_{IN} is the input voltage
- η is the efficiency

While the inductor ripple current depends on the inductance, the frequency, the input voltage, and duty cycle are calculated by [Equation 3](#). Replace [Equation 3](#) and [Equation 7](#) into [Equation 6](#) and get the inductor peak current:

$$I_{PEAK} = \frac{I_{OUT}}{(1-D) \times \eta} + \frac{1}{2} \times \frac{V_{IN} \times D}{L \times f_{SW}} \quad (8)$$

where

- I_{PEAK} is the peak current of the inductor
- I_{OUT} is the output current
- D is the duty cycle
- η is the efficiency
- V_{IN} is the input voltage
- L is the inductor
- f_{SW} is the switching frequency

The heat rating current (RMS) is as below:

$$I_{L_RMS} = \sqrt{I_{IN}^2 + \frac{1}{12}(\Delta I_L)^2} \quad (9)$$

where

- I_{L_RMS} is the RMS current of the inductor
- I_{IN} is the input current of the inductor
- ΔI_L is the ripple current of the inductor

It is important that the peak current does not exceed the inductor saturation current and the RMS current is not over the temperature related rating current of the inductors.

For a given physical inductor size, increasing inductance usually results in an inductor with lower saturation current. The total losses of the coil consists of the DC resistance (DCR) loss and the following frequency dependent loss:

- The losses in the core material (magnetic hysteresis loss, especially at high switching frequencies)
- Additional losses in the conductor from the skin effect (current displacement at high frequencies)
- Magnetic field losses of the neighboring windings (proximity effect)

For a certain inductor, the larger current ripple (smaller inductor) generates the higher DC and also the frequency-dependent loss. An inductor with lower DCR is basically recommended for higher efficiency. However, it is usually a tradeoff between the loss and foot print. [Table 9-2](#) lists some recommended inductors.

Table 9-2. Recommended Inductors

PART NUMBER	L (μH)	DCR TYP (mΩ) MAX	SATURATION CURRENT (A)	SIZE (L × W × H mm)	VENDOR ⁽¹⁾
XGL3515-451ME	0.45	8.2	3.2	3.5 × 3.2 × 1.5	Coilcraft
XGL3515-102ME	1	18.5	2.2	3.5 × 3.2 × 1.5	Coilcraft
TFM252012ALMAR47MTAA	0.47	19	4.9	3.2 × 2.5 × 1.2	TDK
TFM252012ALMA1R0MTAA	1	35	4.7	3.2 × 2.5 × 1.2	TDK

(1) See [Third-party Products Disclaimer](#)

9.2.2.4 Selecting the Output Capacitors

The output capacitor is mainly selected to meet the requirements at load transient or steady state. Then the loop is compensated for the output capacitor selected. The output ripple voltage is related to the equivalent series resistance (ESR) of the capacitor and its capacitance. Assuming a capacitor with zero ESR, the minimum capacitance needed for a given ripple can be calculated by [Equation 10](#):

$$C_{OUT} = \frac{I_{OUT} \times (V_{OUT} - V_{IN})}{f_{SW} \times \Delta V \times V_{OUT}} \quad (10)$$

where

- C_{OUT} is the output capacitor
- I_{OUT} is the output current
- V_{OUT} is the output voltage
- V_{IN} is the input voltage
- ΔV is the output voltage ripple required
- f_{SW} is the switching frequency

The additional output ripple component caused by ESR is calculated by [Equation 11](#):

$$\Delta V_{ESR} = I_{OUT} \times R_{ESR} \quad (11)$$

where

- ΔV_{ESR} is the output voltage ripple caused by ESR

- R_{ESR} is the resistor in series with the output capacitor

For the ceramic capacitor, the ESR ripple can be neglected. However, for tantalum or electrolytic capacitors, it must be considered if used.

The minimum ceramic output capacitance needed to meet a load transient requirement can be estimated using [Equation 12](#):

$$C_{OUT} = \frac{\Delta I_{STEP}}{2\pi \times f_{BW} \times \Delta V_{TRAN}} \quad (12)$$

where

- ΔI_{STEP} is the transient load current step
- ΔV_{TRAN} is the allowed voltage dip for the load current step
- f_{BW} is the control loop bandwidth (that is, the frequency where the control loop gain crosses zero)

For the output capacitor on the OUT pin, the effective capacitance is recommended between 0.22 μ F to 1 μ F.

Care must be taken when evaluating the derating of a ceramic capacitor under the DC bias. Ceramic capacitors can derate by as much as 70% of its capacitance at its rated voltage. Therefore, enough margins on the voltage rating must be considered to ensure adequate capacitance at the required output voltage.

9.2.2.5 Selecting the Input Capacitors

Multilayer ceramic capacitors are an excellent choice for the input decoupling of the step-up converter as they have extremely low ESR and are available in small footprints. Input capacitors must be located as close as possible to the device. While a 22- μ F input capacitor or equivalent is sufficient for the most applications, larger values can be used to reduce input current ripple.

Take care when using only ceramic input capacitors. When a ceramic capacitor is used at the input and the power is being supplied through long wires, such as from a wall adapter, a load step at the output can induce ringing at the V_{IN} pin. This ringing can couple to the output and be mistaken as loop instability or could even damage the part. Additional "bulk" capacitance (electrolytic or tantalum) in this circumstance, must be placed between C_{IN} and the power source lead to reduce ringing that can occur between the inductance of the power source leads and C_{IN} .

9.2.2.6 Loop Stability and Compensation

9.2.2.6.1 Small Signal Model

The TPS61379-Q1 uses the fixed frequency peak current mode control. There is an internal adaptive slope compensation to avoid the subharmonic oscillation. With the inductor current information sensed, the small-signal model of the power stage reduces from a two-pole system, created by L and C_{OUT} , to a single-pole system, created by R_{OUT} and C_{OUT} . The single-pole system is easily used with the loop compensation. [Figure 9-2](#) shows the equivalent small signal elements of a boost converter.

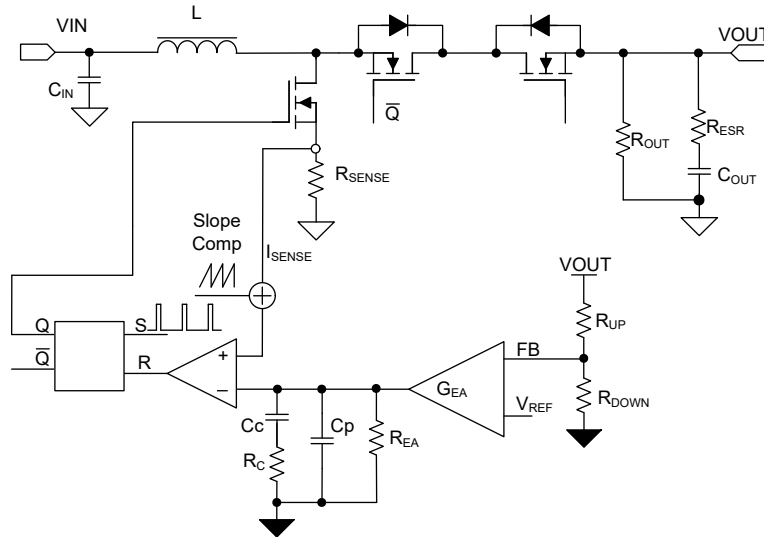

Figure 9-2. TPS61379-Q1 Control Equivalent Circuitry Model

The small signal of power stage is:

$$K_{PS}(S) = \frac{R_{OUT} \times (1 - D)}{2 \times R_{SENSE}} \times \frac{\left(1 + \frac{S}{2\pi \times f_{ESR}}\right) \left(1 - \frac{S}{2\pi \times f_{RHP}}\right)}{\left(1 + \frac{S}{2\pi \times f_p}\right)} \quad (13)$$

where

- D is the duty cycle
- R_{OUT} is the output load resistor
- R_{SENSE} is the equivalent internal current sense resistor, which is typically 118 mΩ

The single pole of the power stage is:

$$f_p = \frac{2}{2\pi \times R_{OUT} \times C_{OUT}} \quad (14)$$

where

- C_{OUT} is the output capacitance. For a boost converter having multiple, identical output capacitors in parallel, simply combine the capacitors with the equivalent capacitance

The zero created by the ESR of the output capacitor is:

$$f_{ESR} = \frac{1}{2\pi \times R_{ESR} \times C_{OUT}} \quad (15)$$

where

- R_{ESR} is the equivalent resistance in series of the output capacitor

The right-hand plane zero is:

$$f_{RHP} = \frac{R_{OUT} \times (1 - D)^2}{2\pi \times L} \quad (16)$$

where

- D is the duty cycle
- R_{OUT} is the output load resistor
- L is the inductance

Equation 17 shows the equation for feedback resistor network and the error amplifier.

$$H_{EA}(S) = G_{EA} \times R_{EA} \times \frac{R_{DOWN}}{R_{UP} + R_{DOWN}} \times \frac{1 + \frac{S}{2 \times \pi \times f_Z}}{\left(1 + \frac{S}{2 \times \pi \times f_{P1}}\right) \times \left(1 + \frac{S}{2 \times \pi \times f_{P2}}\right)} \quad (17)$$

where

- R_{EA} is the output impedance of the error amplifier and typical R_{EA} = 500 MΩ.
- f_{P1}, f_{P2} is the pole's frequency of the compensation, f_Z is the zero's frequency of the compensation network

$$f_{P1} = \frac{1}{2\pi \times R_{EA} \times C_C} \quad (18)$$

where

- C_C is the zero capacitor compensation

$$f_{P2} = \frac{1}{2\pi \times R_C \times C_P} \quad (19)$$

where

- C_P is the pole capacitor compensation
- R_C is the resistor of the compensation network

$$f_Z = \frac{1}{2\pi \times R_C \times C_C} \quad (20)$$

9.2.2.6.2 Loop Compensation Design Steps

With the small signal models coming out, the next step is to calculate the compensation network parameters with the given inductor and output capacitance.

1. Set the Cross Over Frequency, f_C.

The first step is to set the loop crossover frequency, f_C. The higher crossover frequency, the faster the loop response is. It is generally accepted that the loop gain cross over no higher than the lower of either 1/10 of the switching frequency, f_{SW}, or 1/5 of the RHPZ frequency, f_{RHPZ}. Then calculate the loop compensation network values of R_C, C_C, and C_P by the following equations.

2. Set the Compensation Resistor, R_C.

By placing f_Z below f_C, for frequencies above f_C, R_C || R_{EA} ~ = R_C and so R_C × G_{EA} sets the compensation gain. Setting the compensation gain, K_{COMP-dB}, at f_Z, results in the total loop gain, T_(s) = K_{PS(s)} × H_{EA(s)} being zero at f_C.

Therefore, to approximate a single-pole roll-off up to f_{P2}, rearrange Equation 17 to solve for R_C so that the compensation gain, K_{EA}, at f_C is the negative of the gain, K_{PS}, read at frequency f_C for the power stage bode plot or more simply:

$$K_{EA}(f_C) = 20 \times \log\left(G_{EA} \times R_C \times \frac{R_{DOWN}}{R_{UP} + R_{DOWN}}\right) = -K_{PS}(f_C) \quad (21)$$

where

- K_{EA} is gain of the error amplifier network
- K_{PS} is the gain of the power stage
- G_{EA} is the transconductance of the amplifier, the typical value of $G_{EA} = 70 \mu A / V$

3. Set the Compensation Zero capacitor, C_C .

Place the compensation zero at the power stage R_{OUT} , C_{OUT} pole's position to get:

$$f_Z = \frac{1}{2\pi \times R_C \times C_C} \quad (22)$$

Set $f_Z = f_P$, and get

$$C_C = \frac{R_{OUT} \times C_{OUT}}{2R_C} \quad (23)$$

4. Set the Compensation Pole Capacitor, C_P .

Place the compensation pole at the zero produced by the R_{ESR} and the C_{OUT} . It is useful for canceling unhelpful effects of the ESR zero.

$$f_{P2} = \frac{1}{2\pi \times R_C \times C_P} \quad (24)$$

$$f_{ESR} = \frac{1}{2\pi \times R_{ESR} \times C_{OUT}} \quad (25)$$

Set $f_{P2} = f_{ESR}$, and get

$$C_P = \frac{R_{ESR} \times C_{OUT}}{R_C} \quad (26)$$

9.2.2.6.3 Selecting the Bootstrap Capacitor

The bootstrap capacitor between the BST and SW pin supplies the gate current to charge the high-side FET device gate during turn-on of each cycle and also supplies charge for the bootstrap capacitor. The recommended value of the bootstrap capacitor is 0.1 μF to 1 μF . C_{BST} must be a good quality, low-ESR, ceramic capacitor located at the pins of the device to minimize potentially damaging voltage transients caused by trace inductance. A value of 0.1 μF was selected for this design example.

9.2.2.6.4 V_{CC} Capacitor

The primary purpose of the V_{CC} capacitor is to supply the peak transient currents of the driver and bootstrap capacitor as well as provide stability for the V_{CC} regulator. The value of C_{VCC} must be at least 10 times greater than the value of C_{BST} , and must be a good quality, low-ESR, ceramic capacitor. C_{VCC} must be placed close to the pins of the IC to minimize potentially damaging voltage transients caused by the trace inductance. A value of 2.2 μF was selected for this design example.

9.2.3 Application Curves

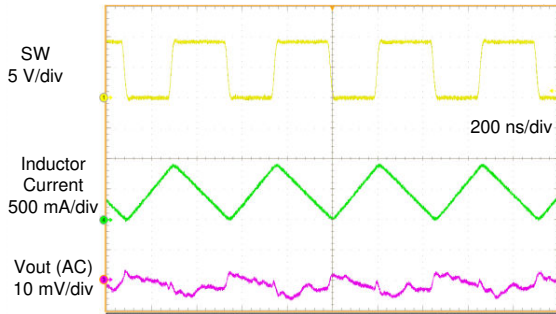

Figure 9-3. Switching Waveform $V_{IN} = 5\text{ V}$, $V_{OUT} = 9\text{ V}$, $I_{OUT} = 250\text{ mA}$, FPWM

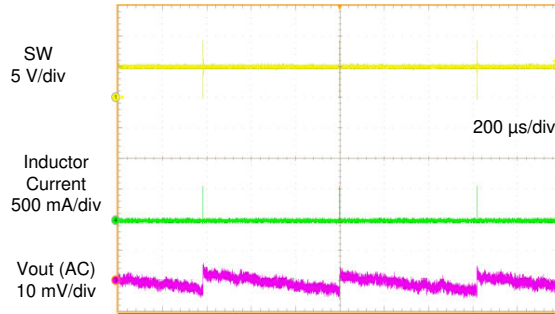

Figure 9-4. Switching Waveform $V_{IN} = 5\text{ V}$, $V_{OUT} = 9\text{ V}$, $I_{OUT} = 0\text{ mA}$, Auto PFM

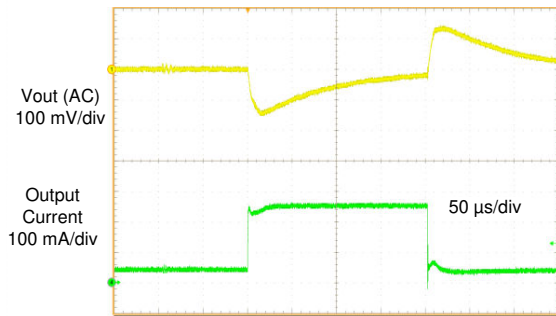

Figure 9-5. Load Transient $V_{IN} = 5\text{ V}$, $V_{OUT} = 9\text{ V}$, $I_{OUT} = 50\text{ mA}$ to 250 mA , FPWM

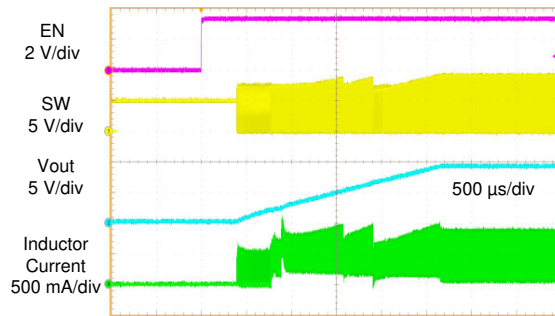

Figure 9-6. Start-up from EN Waveform $V_{IN} = 5\text{ V}$, $V_{OUT} = 9\text{ V}$, $I_{OUT} = 250\text{ mA}$, FPWM

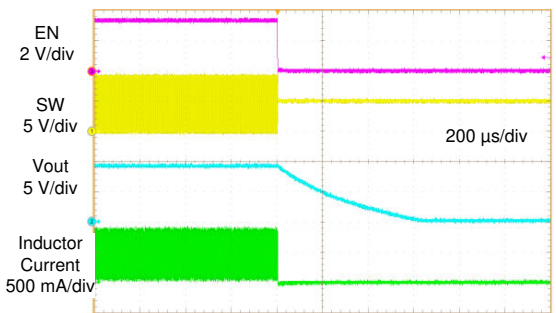

Figure 9-7. Shutdown from EN Waveforms $V_{IN} = 5\text{ V}$, $V_{OUT} = 9\text{ V}$, $I_{OUT} = 250\text{ mA}$, FPWM

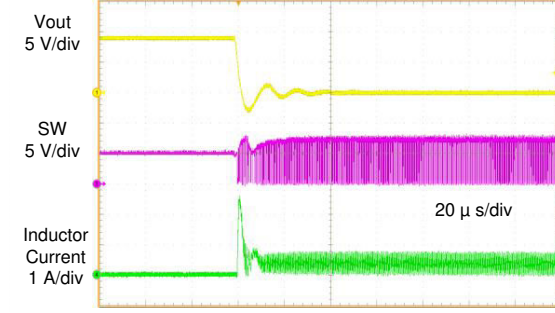

Figure 9-8. Short Circuit Protection $V_{IN} = 5\text{ V}$, $V_{OUT} = 9\text{ V}$, FPWM

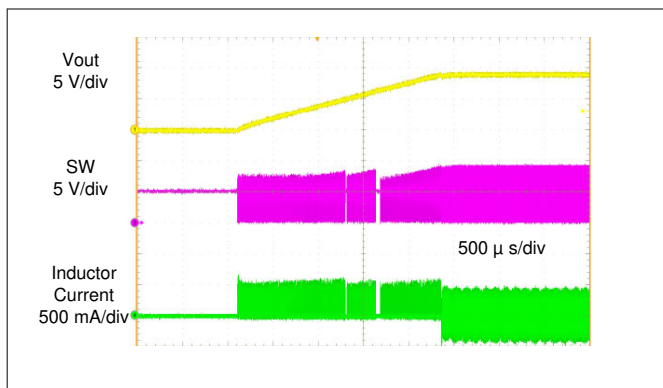

Figure 9-9. Short Circuit Recovery $V_{IN} = 5\text{ V}$, $V_{OUT} = 9\text{ V}$, $I_{OUT} = 0\text{ mA}$, FPWM

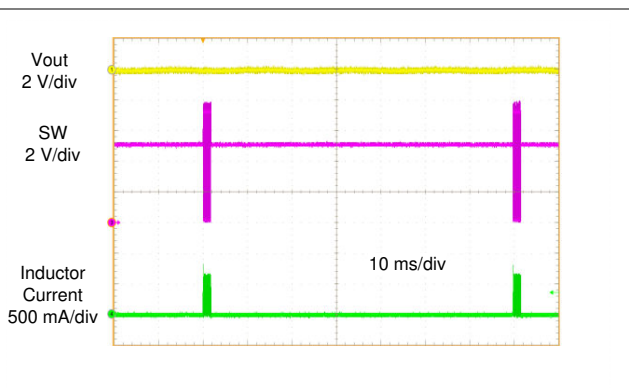

Figure 9-10. Hiccup Short Circuit Protection $V_{IN} = 5\text{ V}$, $V_{OUT} = 9\text{ V}$, FPWM

10 Power Supply Recommendations

The TPS61379-Q1 is designed to operate from an input voltage supply range between 2.3 V to 14 V. This input supply must be well regulated. If the input supply is located more than a few inches from the device, the bulk capacitance can be required in addition to the ceramic bypass capacitors. An electrolytic capacitor with a value of 47 μF is a typical choice.

11 Layout

11.1 Layout Guidelines

As for all switching power supplies, the layout is an important step in the design, especially at high peak currents and high switching frequencies. If the layout is not carefully done, the regulator can show stability problems as well as EMI problems. Therefore, use wide and short traces for the main current path and for the power ground paths. The input and output capacitor, as well as the inductor must be placed as close as possible to the IC.

11.2 Layout Example

The bottom layer is a large GND plane connected by vias.

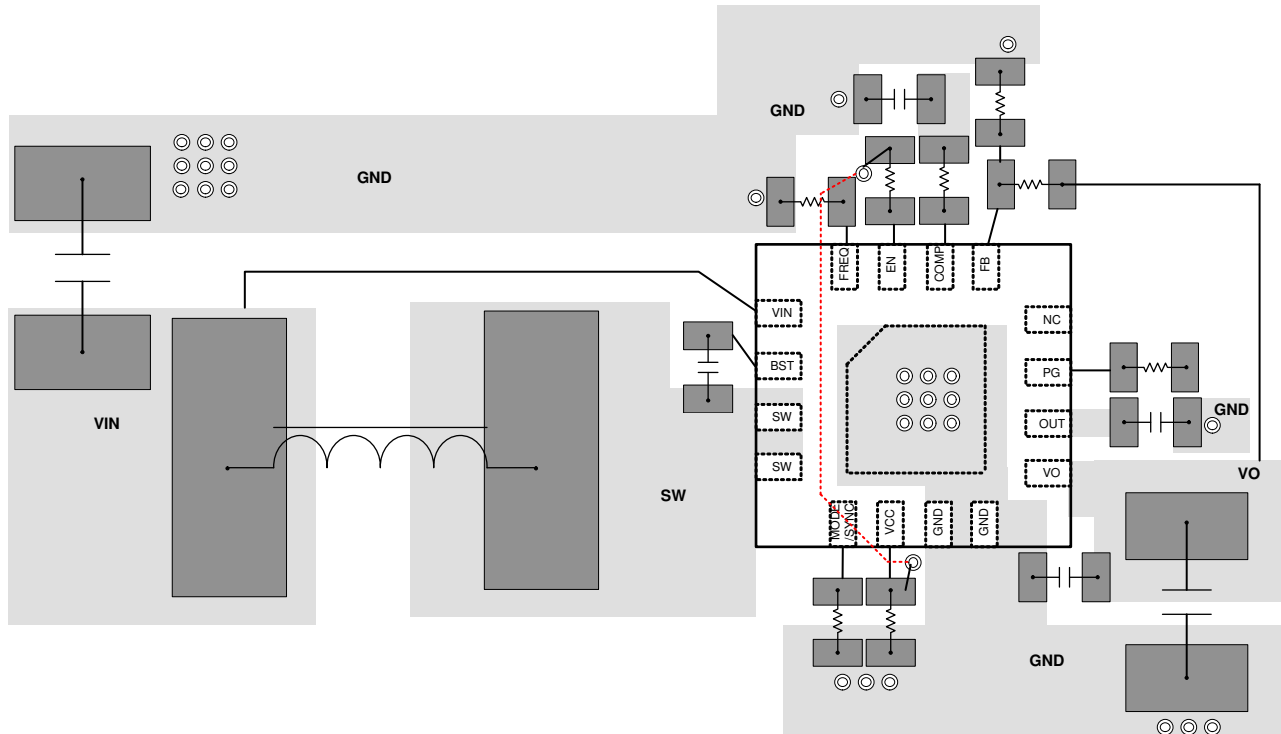

Figure 11-1. Recommended Layout

12 Device and Documentation Support

12.1 Device Support

12.1.1 Third-Party Products Disclaimer

TI'S PUBLICATION OF INFORMATION REGARDING THIRD-PARTY PRODUCTS OR SERVICES DOES NOT CONSTITUTE AN ENDORSEMENT REGARDING THE SUITABILITY OF SUCH PRODUCTS OR SERVICES OR A WARRANTY, REPRESENTATION OR ENDORSEMENT OF SUCH PRODUCTS OR SERVICES, EITHER ALONE OR IN COMBINATION WITH ANY TI PRODUCT OR SERVICE.

12.2 Receiving Notification of Documentation Updates

To receive notification of documentation updates, navigate to the device product folder on ti.com. Click on *Subscribe to updates* to register and receive a weekly digest of any product information that has changed. For change details, review the revision history included in any revised document.

12.3 Support Resources

[TI E2E™ support forums](#) are an engineer's go-to source for fast, verified answers and design help — straight from the experts. Search existing answers or ask your own question to get the quick design help you need.

Linked content is provided "AS IS" by the respective contributors. They do not constitute TI specifications and do not necessarily reflect TI's views; see TI's [Terms of Use](#).

12.4 Trademarks

TI E2E™ is a trademark of Texas Instruments.

All trademarks are the property of their respective owners.

12.5 Glossary

[TI Glossary](#) This glossary lists and explains terms, acronyms, and definitions.

12.6 Electrostatic Discharge Caution



This integrated circuit can be damaged by ESD. Texas Instruments recommends that all integrated circuits be handled with appropriate precautions. Failure to observe proper handling and installation procedures can cause damage.

ESD damage can range from subtle performance degradation to complete device failure. Precision integrated circuits may be more susceptible to damage because very small parametric changes could cause the device not to meet its published specifications.

13 Mechanical, Packaging, and Orderable Information

The following pages include mechanical, packaging, and orderable information. This information is the most current data available for the designated devices. This data is subject to change without notice and revision of this document. For browser-based versions of this data sheet, refer to the left-hand navigation.

PACKAGING INFORMATION

Orderable Device	Status (1)	Package Type	Package Drawing	Pins	Package Qty	Eco Plan (2)	Lead finish/ Ball material (6)	MSL Peak Temp (3)	Op Temp (°C)	Device Marking (4/5)	Samples
TPS61379QWRTERQ1	ACTIVE	WQFN	RTE	16	3000	RoHS & Green	NIPDAU	Level-2-260C-1 YEAR	-40 to 125	2H1H	Samples

(1) The marketing status values are defined as follows:

ACTIVE: Product device recommended for new designs.

LIFEBUY: TI has announced that the device will be discontinued, and a lifetime-buy period is in effect.

NRND: Not recommended for new designs. Device is in production to support existing customers, but TI does not recommend using this part in a new design.

PREVIEW: Device has been announced but is not in production. Samples may or may not be available.

OBSOLETE: TI has discontinued the production of the device.

(2) **RoHS:** TI defines "RoHS" to mean semiconductor products that are compliant with the current EU RoHS requirements for all 10 RoHS substances, including the requirement that RoHS substance do not exceed 0.1% by weight in homogeneous materials. Where designed to be soldered at high temperatures, "RoHS" products are suitable for use in specified lead-free processes. TI may reference these types of products as "Pb-Free".

RoHS Exempt: TI defines "RoHS Exempt" to mean products that contain lead but are compliant with EU RoHS pursuant to a specific EU RoHS exemption.

Green: TI defines "Green" to mean the content of Chlorine (Cl) and Bromine (Br) based flame retardants meet JS709B low halogen requirements of <=1000ppm threshold. Antimony trioxide based flame retardants must also meet the <=1000ppm threshold requirement.

(3) MSL, Peak Temp. - The Moisture Sensitivity Level rating according to the JEDEC industry standard classifications, and peak solder temperature.

(4) There may be additional marking, which relates to the logo, the lot trace code information, or the environmental category on the device.

(5) Multiple Device Markings will be inside parentheses. Only one Device Marking contained in parentheses and separated by a "-" will appear on a device. If a line is indented then it is a continuation of the previous line and the two combined represent the entire Device Marking for that device.

(6) Lead finish/Ball material - Orderable Devices may have multiple material finish options. Finish options are separated by a vertical ruled line. Lead finish/Ball material values may wrap to two lines if the finish value exceeds the maximum column width.

Important Information and Disclaimer:The information provided on this page represents TI's knowledge and belief as of the date that it is provided. TI bases its knowledge and belief on information provided by third parties, and makes no representation or warranty as to the accuracy of such information. Efforts are underway to better integrate information from third parties. TI has taken and continues to take reasonable steps to provide representative and accurate information but may not have conducted destructive testing or chemical analysis on incoming materials and chemicals. TI and TI suppliers consider certain information to be proprietary, and thus CAS numbers and other limited information may not be available for release.

In no event shall TI's liability arising out of such information exceed the total purchase price of the TI part(s) at issue in this document sold by TI to Customer on an annual basis.

TAPE AND REEL INFORMATION

QUADRANT ASSIGNMENTS FOR PIN 1 ORIENTATION IN TAPE

*All dimensions are nominal

Device	Package Type	Package Drawing	Pins	SPQ	Reel Diameter (mm)	Reel Width W1 (mm)	A0 (mm)	B0 (mm)	K0 (mm)	P1 (mm)	W (mm)	Pin1 Quadrant
TPS61379QWRTERQ1	WQFN	RTE	16	3000	330.0	12.4	3.3	3.3	1.1	8.0	12.0	Q2

TAPE AND REEL BOX DIMENSIONS

*All dimensions are nominal

Device	Package Type	Package Drawing	Pins	SPQ	Length (mm)	Width (mm)	Height (mm)
TPS61379QWRTERQ1	WQFN	RTE	16	3000	367.0	367.0	35.0

GENERIC PACKAGE VIEW

RTE 16

WQFN - 0.8 mm max height

3 x 3, 0.5 mm pitch

PLASTIC QUAD FLATPACK - NO LEAD

This image is a representation of the package family, actual package may vary.
Refer to the product data sheet for package details.

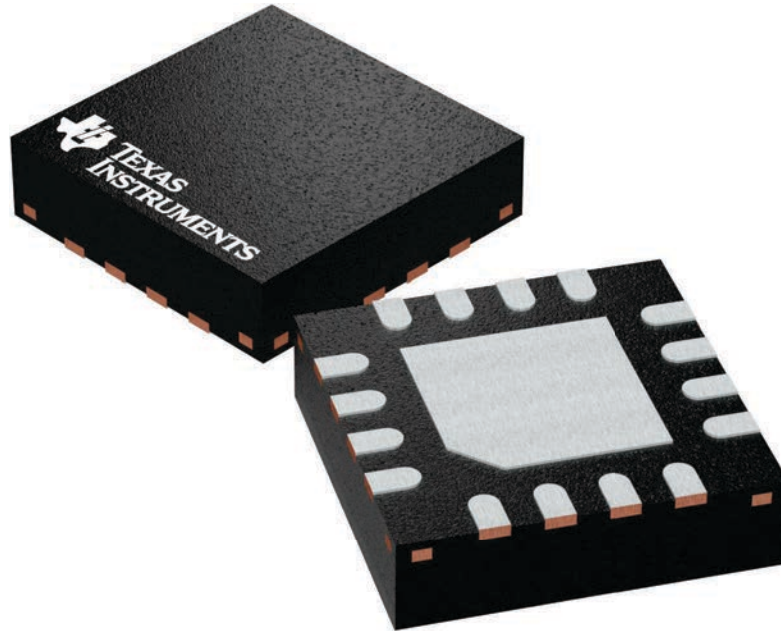

4225944/A

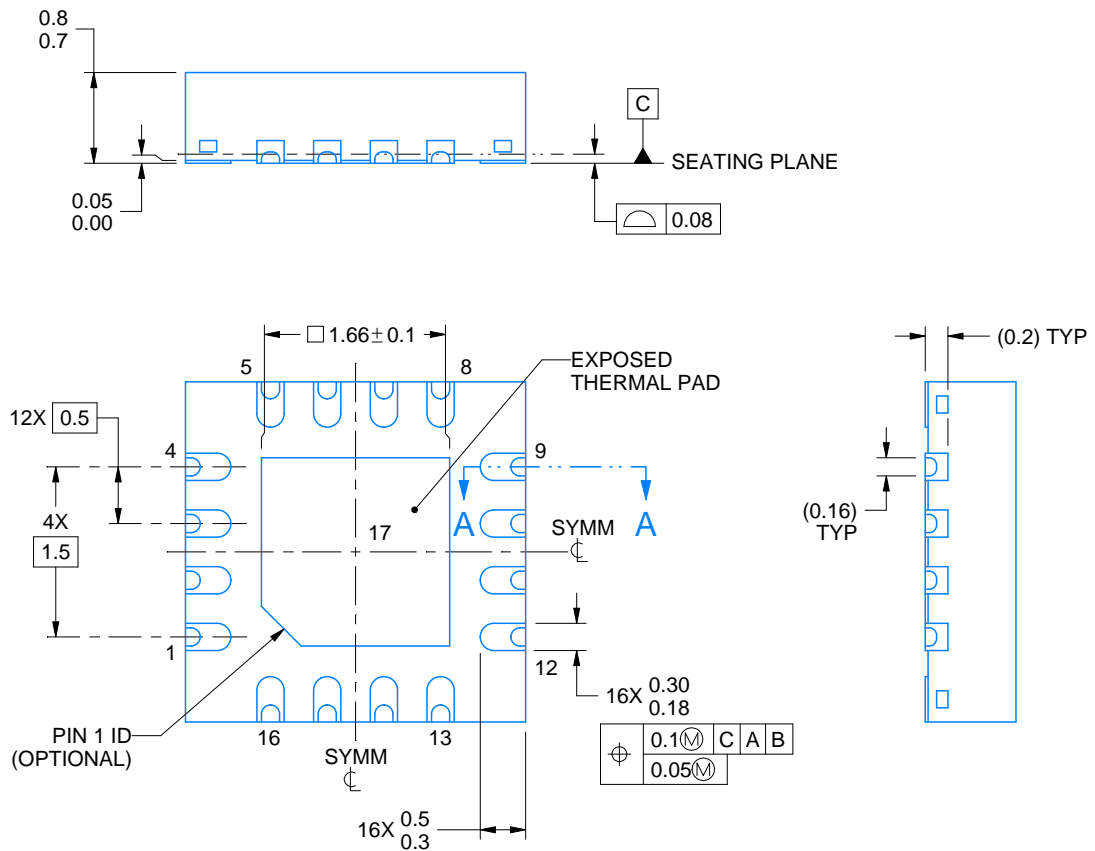
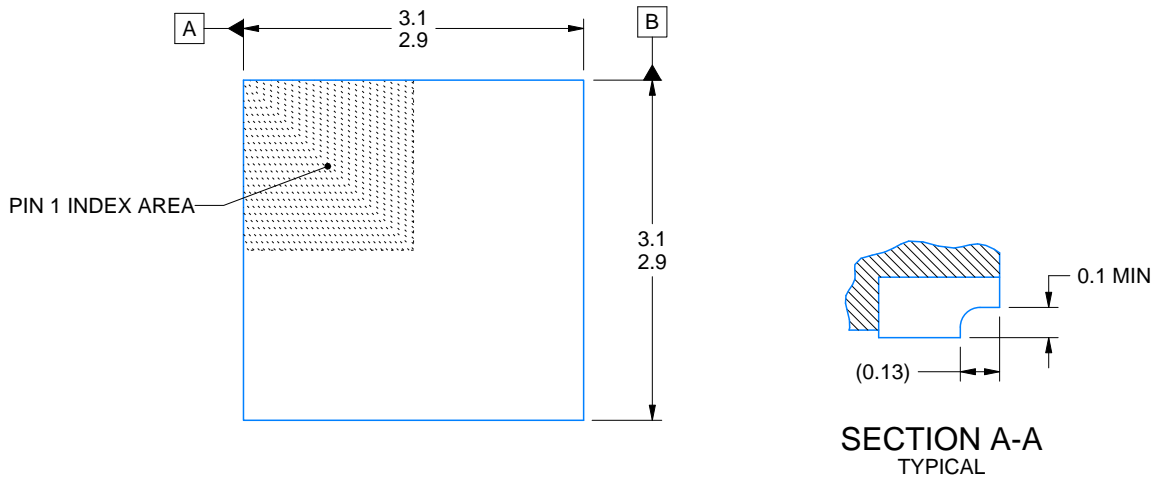
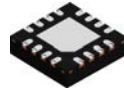

4224938/C 03/2022

NOTES:

1. All linear dimensions are in millimeters. Any dimensions in parenthesis are for reference only. Dimensioning and tolerancing per ASME Y14.5M.
2. This drawing is subject to change without notice.
3. The package thermal pad must be soldered to the printed circuit board for thermal and mechanical performance.

EXAMPLE BOARD LAYOUT

RTE0016K

WQFN - 0.8 mm max height

PLASTIC QUAD FLATPACK - NO LEAD

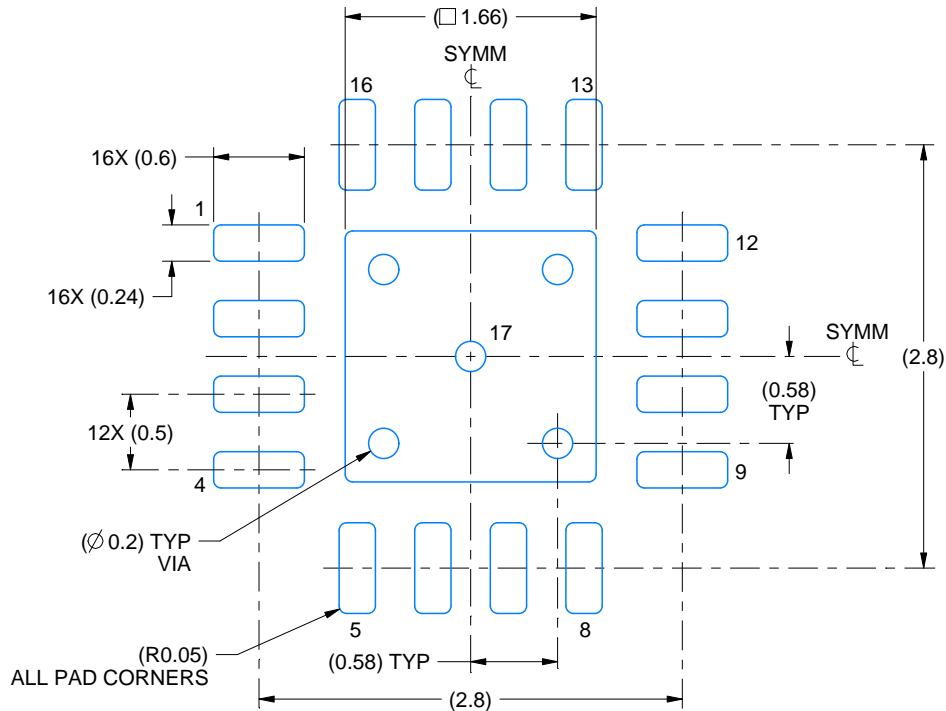

LAND PATTERN EXAMPLE
EXPOSED METAL SHOWN
SCALE:20X

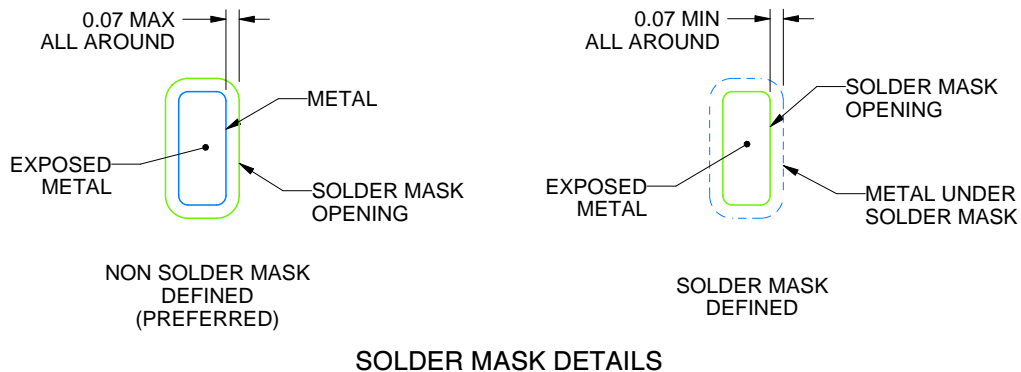

SOLDER MASK DETAILS

4224938/C 03/2022

NOTES: (continued)

4. This package is designed to be soldered to a thermal pad on the board. For more information, see Texas Instruments literature number SLUA271 (www.ti.com/lit/sluea271).
5. Vias are optional depending on application, refer to device data sheet. If any vias are implemented, refer to their locations shown on this view. It is recommended that vias under paste be filled, plugged or tented.

EXAMPLE STENCIL DESIGN

RTE0016K

WQFN - 0.8 mm max height

PLASTIC QUAD FLATPACK - NO LEAD

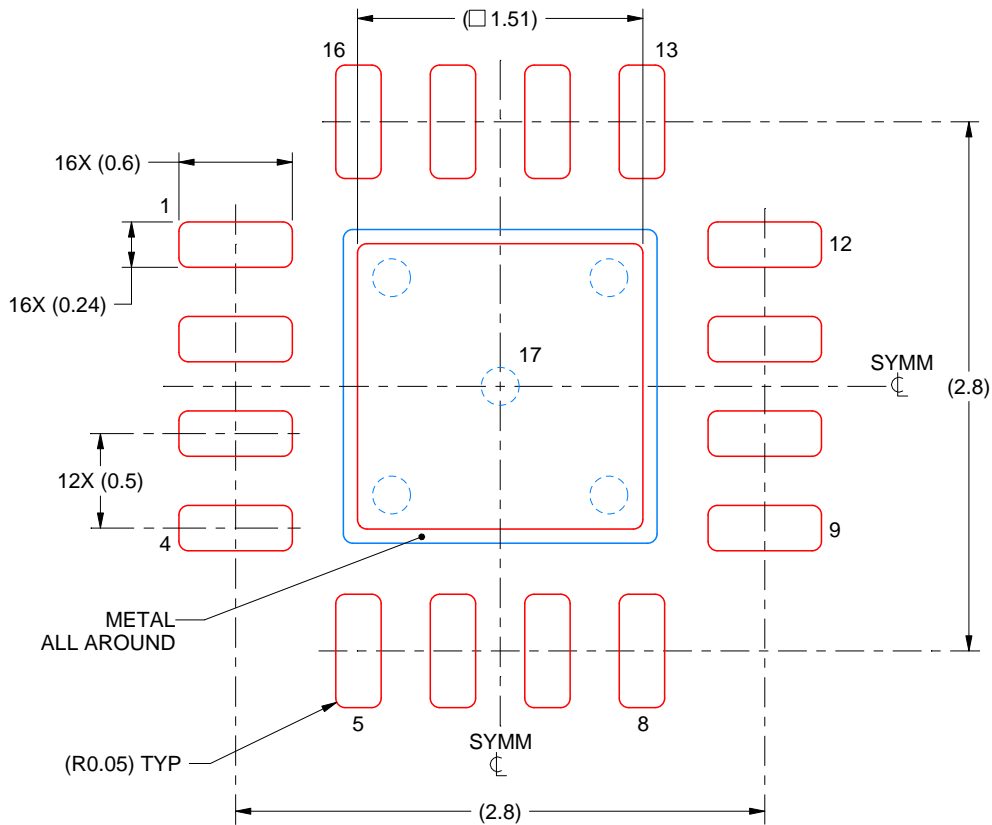

SOLDER PASTE EXAMPLE
BASED ON 0.125 mm THICK STENCIL

EXPOSED PAD 17:
84% PRINTED SOLDER COVERAGE BY AREA UNDER PACKAGE
SCALE:25X

4224938/C 03/2022

NOTES: (continued)

6. Laser cutting apertures with trapezoidal walls and rounded corners may offer better paste release. IPC-7525 may have alternate design recommendations.

IMPORTANT NOTICE AND DISCLAIMER

TI PROVIDES TECHNICAL AND RELIABILITY DATA (INCLUDING DATA SHEETS), DESIGN RESOURCES (INCLUDING REFERENCE DESIGNS), APPLICATION OR OTHER DESIGN ADVICE, WEB TOOLS, SAFETY INFORMATION, AND OTHER RESOURCES "AS IS" AND WITH ALL FAULTS, AND DISCLAIMS ALL WARRANTIES, EXPRESS AND IMPLIED, INCLUDING WITHOUT LIMITATION ANY IMPLIED WARRANTIES OF MERCHANTABILITY, FITNESS FOR A PARTICULAR PURPOSE OR NON-INFRINGEMENT OF THIRD PARTY INTELLECTUAL PROPERTY RIGHTS.

These resources are intended for skilled developers designing with TI products. You are solely responsible for (1) selecting the appropriate TI products for your application, (2) designing, validating and testing your application, and (3) ensuring your application meets applicable standards, and any other safety, security, regulatory or other requirements.

These resources are subject to change without notice. TI grants you permission to use these resources only for development of an application that uses the TI products described in the resource. Other reproduction and display of these resources is prohibited. No license is granted to any other TI intellectual property right or to any third party intellectual property right. TI disclaims responsibility for, and you will fully indemnify TI and its representatives against, any claims, damages, costs, losses, and liabilities arising out of your use of these resources.

TI's products are provided subject to [TI's Terms of Sale](#) or other applicable terms available either on ti.com or provided in conjunction with such TI products. TI's provision of these resources does not expand or otherwise alter TI's applicable warranties or warranty disclaimers for TI products.

TI objects to and rejects any additional or different terms you may have proposed.

Mailing Address: Texas Instruments, Post Office Box 655303, Dallas, Texas 75265
Copyright © 2022, Texas Instruments Incorporated