

TMP23x-Q1 Automotive Grade, High-Accuracy Analog Output Temperature Sensors

1 Features

- AEC-Q100 qualified for automotive applications
 - TMP235-Q1 grade 0: -40°C to $+150^{\circ}\text{C}$
 - TMP236-Q1 grade 1: -40°C to $+125^{\circ}\text{C}$
- **Functional Safety-Capable**
 - [Documentation available to aid functional safety system design](#)
- Tight accuracy across a wide temperature range:
 - $\pm 2.5^{\circ}\text{C}$ (maximum): -40°C to $+150^{\circ}\text{C}$ (TMP235-Q1)
 - $\pm 2.5^{\circ}\text{C}$ (maximum): -10°C to $+125^{\circ}\text{C}$ (TMP236-Q1)
- Positive slope sensor gain, offset (typical):
 - $10\text{ mV}/^{\circ}\text{C}$, 500 mV at 0°C (TMP235-Q1)
 - $19.5\text{ mV}/^{\circ}\text{C}$, 400 mV at 0°C (TMP236-Q1)
- Wide operating supply voltage range:
 - 2.3 V to 5.5 V (TMP235-Q1)
 - 3.1 V to 5.5 V (TMP236-Q1)
- Short-circuit protected output
- Low power: $9\text{ }\mu\text{A}$ (typical)
- Strong output for driving loads up to 1000 pF
- Available package options:
 - 5-pin SC70 (DCK) surface mount
 - 3-pin SOT-23 (DBZ) surface mount
 - Footprint compatible with industry-standard LMT8x-Q1, LM50-Q1, and LM20 temperature sensors
- Cost-effective alternative to thermistors

2 Applications

- Automotive head unit
- Electric power steering (EPS)
- Shifter system
- Battery management system (BMS)
- Gasoline engine

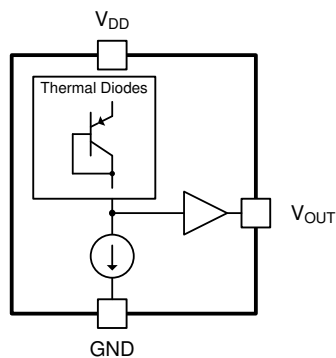

Functional Block Diagram

3 Description

The TMP23x-Q1 devices are a family of automotive grade precision CMOS integrated-circuit linear analog temperature sensors with an output voltage proportional to temperature, serving various automotive applications from powertrain to infotainment. These temperature sensors have a typical accuracy from 0°C to $+70^{\circ}\text{C}$ of $\pm 0.5^{\circ}\text{C}$. The TMP235-Q1 device provides a positive slope output of $10\text{ mV}/^{\circ}\text{C}$ over the full -40°C to $+150^{\circ}\text{C}$ temperature range and a supply range from 2.3 V to 5.5 V . The higher gain TMP236-Q1 sensor provides a positive slope output of $19.5\text{ mV}/^{\circ}\text{C}$ from -10°C to $+125^{\circ}\text{C}$ and a supply range from 3.1 V to 5.5 V .

The $9\text{-}\mu\text{A}$ typical quiescent current and $800\text{-}\mu\text{s}$ typical power-on time enable effective power-cycling architectures to minimize power consumption for battery-powered devices. A class-AB output driver provides a strong $500\text{-}\mu\text{A}$ maximum output to drive capacitive loads up to 1000 pF and is designed to directly interface to analog-to-digital converter sample and hold inputs. With excellent accuracy and a strong linear output driver, the TMP23x-Q1 analog output temperature sensors are cost-effective alternatives to passive thermistors.

Device Information⁽¹⁾

PART NUMBER	PACKAGE	BODY SIZE (NOM)
TMP235-Q1,	SC70 (5)	$2.00\text{ mm} \times 1.25\text{ mm}$
TMP236-Q1	SOT-23 (3)	$2.92\text{ mm} \times 1.30\text{ mm}$

- (1) For all available packages, see the orderable addendum at the end of the data sheet.

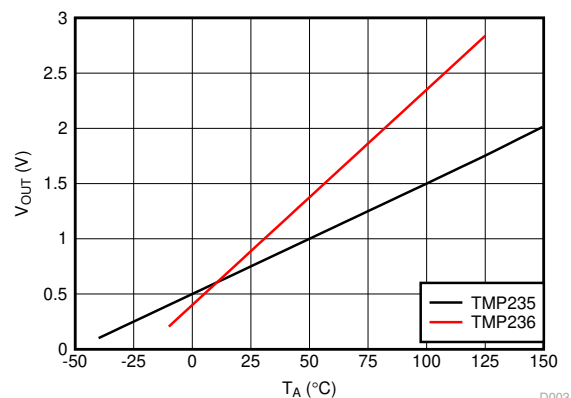

Output Voltage vs Ambient



Table of Contents

1 Features	1	7.4 Device Functional Modes.....	10
2 Applications	1	8 Application and Implementation	11
3 Description	1	8.1 Application Information.....	11
4 Revision History	2	8.2 Typical Application.....	11
5 Pin Configuration and Functions	3	9 Power Supply Recommendations	12
6 Specifications	4	10 Layout	12
6.1 Absolute Maximum Ratings.....	4	10.1 Layout Guidelines.....	12
6.2 ESD Ratings.....	4	10.2 Layout Examples.....	12
6.3 Recommended Operating Conditions.....	4	11 Device and Documentation Support	13
6.4 Thermal Information.....	4	11.1 Receiving Notification of Documentation Updates..	13
6.5 Electrical Characteristics.....	5	11.2 Support Resources.....	13
6.6 Typical Characteristics.....	6	11.3 Trademarks.....	13
7 Detailed Description	8	11.4 Electrostatic Discharge Caution.....	13
7.1 Overview.....	8	11.5 Glossary.....	13
7.2 Functional Block Diagram.....	8	12 Mechanical, Packaging, and Orderable Information	13
7.3 Feature Description.....	8		

4 Revision History

NOTE: Page numbers for previous revisions may differ from page numbers in the current version.

Changes from Revision C (November 2019) to Revision D (June 2022)	Page
• Updated the numbering format for tables, figures, and cross-references throughout the document.....	1
• Added Functional Safety bullets to the <i>Features</i> section.....	1
<hr/>	
Changes from Revision B (October 2019) to Revision C (November 2019)	Page
• Added temperature accuracy specs for the TMP236-Q1 SOT-23 package.....	5
<hr/>	
Changes from Revision A (May 2019) to Revision B (October 2019)	Page
• Changed document status from Advance Information to Production Data.....	1
<hr/>	
Changes from Revision * (April 2019) to Revision A (May 2019)	Page
• Changed recommended operating temperature range from: –50°C to 150°C to: –40°C to 150°C	4

5 Pin Configuration and Functions

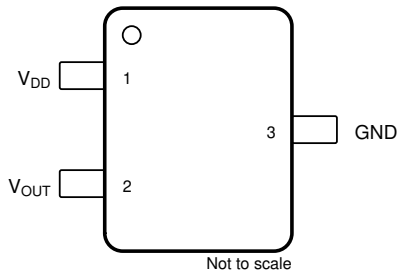
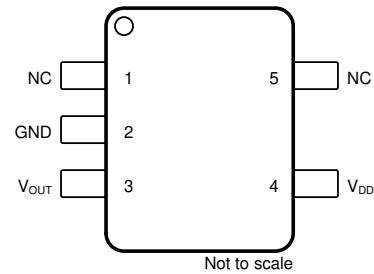

Figure 5-1. DBZ Package 3-Pin SOT-23 Top View



NC- no internal connection
Figure 5-2. DCK Package 5-Pin SC70 Top View

Table 5-1. Pin Functions

NAME	PIN		TYPE	DESCRIPTION
	SOT-23	SC70		
GND	3	2	Ground	Power supply ground.
NC	—	5	—	No internal connection. This pin may be left floating or connected to GND.
NC	—	1	—	No internal connection. This pin may be left floating or connected to GND.
V _{OUT}	2	3	O	Outputs voltage proportional to temperature
V _{DD}	1	4	I	Positive supply input

6 Specifications

6.1 Absolute Maximum Ratings

over operating free-air temperature range (unless otherwise noted) ⁽¹⁾

	MIN	MAX	UNIT
Supply voltage, V_{DD}		+6	V
Output voltage, V_{OUT}	-0.3 ($V_{DD} + 0.3$)		
Output current	-30	+30	mA
Latch-up current, each pin	-200	+200	
Junction temperature (T_J)		+150	°C
Storage temperature (T_{stg})	-65	+150	

- (1) Stresses beyond those listed under *Absolute Maximum Ratings* may cause permanent damage to the device. These are stress ratings only, which do not imply functional operation of the device at these or any other conditions beyond those indicated under *Recommended Operating Conditions*. Exposure to absolute-maximum-rated conditions for extended periods may affect device reliability.

6.2 ESD Ratings

			VALUE	UNIT	
$V_{(ESD)}$	Electrostatic discharge	Human body model (HBM), per AEC Q100-002 ⁽¹⁾ HBM ESD Classification Level 2	±2000	V	
		Charged device model (CDM), per AEC Q100-011 CDM ESD Classification Level C4B	All Pins	±500	V
			Corner Pins	±750	V

- (1) AEC Q100-002 indicates that HBM stressing shall be in accordance with the ANSI/ESDA/JEDEC JS-001 specification

6.3 Recommended Operating Conditions

over operating free-air temperature range (unless otherwise noted)

		MIN	NOM	MAX	UNIT
V_{DD}	Input voltage (TMP235-Q1)	2.3		5.5	V
	Input voltage (TMP236-Q1)	3.1		5.5	
T_A	Operating free-air temperature	-40		150	°C

6.4 Thermal Information

THERMAL METRIC ⁽¹⁾ ⁽²⁾		TMP23X-Q1		UNIT
		DCK (SC70)	DBZ (SOT-23)	
		5 PINS	3 PINS	
$R_{\theta JA}$	Junction-to-ambient thermal resistance ⁽³⁾ ⁽⁴⁾	275	167	°C/W
$R_{\theta JC(top)}$	Junction-to-case (top) thermal resistance	84	90	°C/W
$R_{\theta JB}$	Junction-to-board thermal resistance	56	146	°C/W
Ψ_{JT}	Junction-to-top characterization parameter	1.2	35	°C/W
Ψ_{JB}	Junction-to-board characterization parameter	55	146	°C/W

- (1) For more information about traditional and new thermal metrics, see the [Semiconductor and IC Package Thermal Metrics](#) application report.
- (2) For information on self-heating and thermal response time see [Layout Guidelines](#) section.
- (3) The junction to ambient thermal resistance ($R_{\theta JA}$) under natural convection is obtained in a simulation on a JEDEC-standard, High-K board as specified in JESD51-7, in an environment described in JESD51-2. Exposed pad packages assume that thermal vias are included in the PCB, per JESD 51-5.
- (4) Changes in output due to self heating can be computed by multiplying the internal dissipation by the thermal resistance.

6.5 Electrical Characteristics

TMP235-Q1: $V_{DD} = 2.3\text{ V to }5.5\text{ V}$, GND = Ground, $T_A = -40^\circ\text{C to }+125^\circ\text{C}$ and no load (unless otherwise noted)

TMP236-Q1: $V_{DD} = 3.1\text{ V to }5.5\text{ V}$, GND = Ground, $T_A = -10^\circ\text{C to }+125^\circ\text{C}$ and no load (unless otherwise noted)

PARAMETER		TEST CONDITIONS	MIN	TYP	MAX	UNIT	
POWER SUPPLY							
I_{DD}	Operating current	$T_A = 25^\circ\text{C}$, $V_{DD} = 2.3\text{ V}$, TMP235-Q1		9		μA	
		$T_A = 25^\circ\text{C}$, $V_{DD} = 3.1\text{ V}$, TMP236-Q1		10			
		$T_A = -40^\circ\text{C to }+125^\circ\text{C}$, TMP235-Q1			14.5		
		$T_A = -10^\circ\text{C to }+125^\circ\text{C}$, TMP236-Q1					15
		$T_A = 150^\circ\text{C}$, TMP235-Q1					17
$\Delta^\circ\text{C}/\Delta V_{DD}$	Line regulation		-0.1	0.02	0.1	$^\circ\text{C/V}$	
SENSOR ACCURACY							
T_{ACY}	Temperature accuracy ⁽¹⁾	$T_A = 25^\circ\text{C}$		± 0.5		$^\circ\text{C}$	
		$T_A = 0^\circ\text{C to }70^\circ\text{C}$ (SC70 Package) (TMP235-Q1)	-1.5	± 0.5	+1.2		
		$T_A = 0^\circ\text{C to }70^\circ\text{C}$ (SOT-23 Package) (TMP235-Q1)	-1.5	± 0.5	+1.2		
		$T_A = -40^\circ\text{C to }125^\circ\text{C}$ (TMP235-Q1)	-2.5	± 0.5	+2.5		
		$T_A = -40^\circ\text{C to }150^\circ\text{C}$ (TMP235-Q1)	-2.5	± 0.5	+2.5		
		$T_A = -10^\circ\text{C to }125^\circ\text{C}$ (TMP236-Q1)	-2.5	± 0.5	+2.5		
T_{ACY}	Temperature accuracy ⁽¹⁾	$T_A = 0^\circ\text{C to }70^\circ\text{C}$ (SOT-23 Package) (TMP236-Q1)	-1.5	± 0.5	+1.5	$^\circ\text{C}$	
SENSOR OUTPUT							
$V_{0^\circ\text{C}}$	Output voltage offset at 0°C	TMP235-Q1		500		mV	
		TMP236-Q1		400			
T_C	Temperature coefficient (sensor gain)	TMP235-Q1		10		$\text{mV}/^\circ\text{C}$	
		TMP236-Q1		19.5			
V_{ONL}	Output nonlinearity ⁽²⁾	$T_A = 0^\circ\text{C to }70^\circ\text{C}$, no load		± 0.5		$^\circ\text{C}$	
I_{OUT}	Output current				500	μA	
Z_{OUT}	Output impedance	$I_{OUT} = 100\ \mu\text{A}$, $f = 100\text{ Hz}$		20		Ω	
		$I_{OUT} = 100\ \mu\text{A}$, $f = 500\text{ Hz}$		50			
	Output load regulation	$T_A = 0^\circ\text{C to }70^\circ\text{C}$, $I_{OUT} = 100\ \mu\text{A}$, $\Delta V_{OUT} / \Delta I_{OUT}$		1		Ω	
t_{ON}	Turn on time	Time to reach accuracy within $\pm 0.5^\circ\text{C}$		800		μs	
C_{LOAD}	Typical load capacitance				1000	pF	
t_{RES}	Thermal response to 63%	SC70	30°C (Air) to $+125^\circ\text{C}$ (Fluid Bath)		1.3	s	

- (1) Accuracy is defined as the error between the measured and reference output voltages, tabulated in the [TMP235-Q1 Transfer Table](#) and [TMP236-Q1 Transfer Table](#) at the specified conditions of supply voltage and temperature (expressed in $^\circ\text{C}$). Accuracy limits include line regulation within the specified conditions. Accuracy limits do not include load regulation; they assume no DC load.
- (2) Nonlinearity is defined as the deviation of the output-voltage-versus-temperature curve from the best-fit straight line, over the device's rated temperature range.

6.6 Typical Characteristics

at $T_A = 25^\circ\text{C}$, (unless otherwise noted)

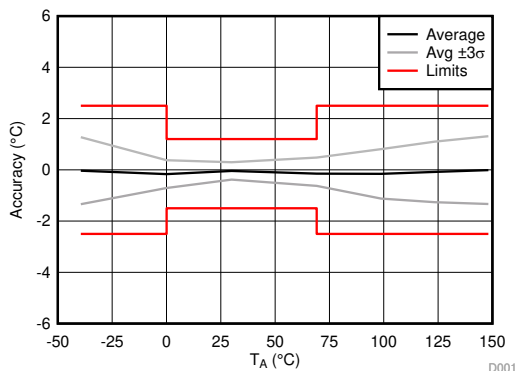

TMP235-Q1: $V_{DD} = 2.3$ to 5.5 V, $I_{OUT} = 0$ μA , $C_{LOAD} = 1000$ pF

Figure 6-1. Accuracy vs T_A Temperature

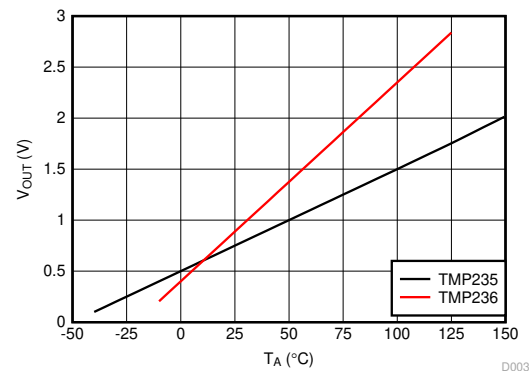

$I_{OUT} = 0$ μA , $C_{LOAD} = 1000$ pF

Figure 6-2. Output Voltage vs Ambient Temperature

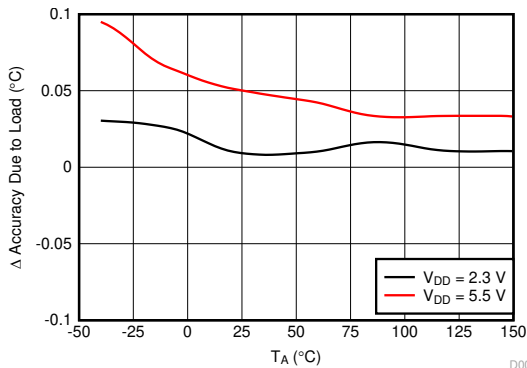

TMP23x-Q1: I_{OUT} = from 0 μA to 100 μA , $C_{LOAD} = 1000$ pF

Figure 6-3. Changes in Accuracy vs Ambient Temperature (Due to Load)

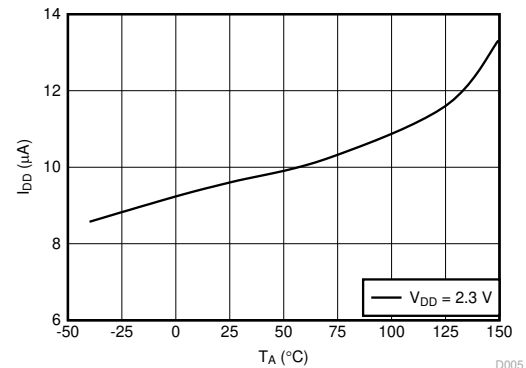

TMP23x-Q1: $I_{OUT} = 0$ μA , $C_{LOAD} = 1000$ pF

Figure 6-4. Supply Current vs Temperature

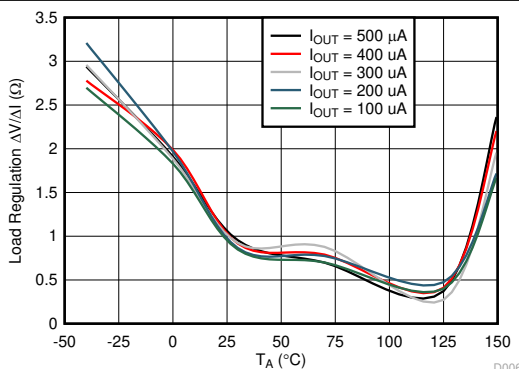

TMP23x-Q1: $V_{DD} = 2.3$ V, $C_{LOAD} = 1000$ pF

Figure 6-5. Load Regulation vs Ambient Temperature

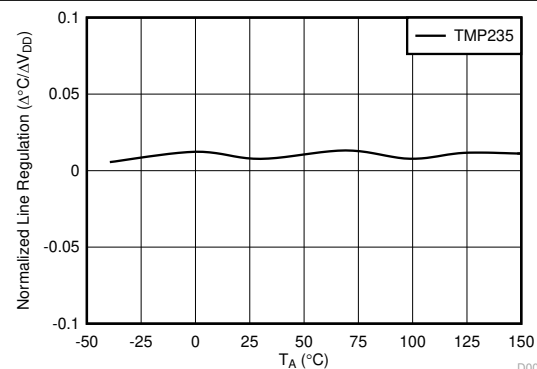

TMP23x-Q1: $V_{DD} = 2.3$ to 5.5 V, $I_{OUT} = 0$ μA , $C_{LOAD} = 1000$ pF

Figure 6-6. Line Regulation ($\Delta^\circ\text{C} / \Delta V_{DD}$) vs Ambient Temperature

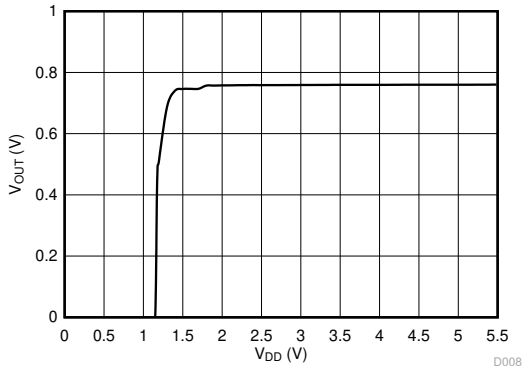

TMP23x-Q1: $T_A = 25^\circ\text{C}$
Figure 6-7. Output Voltage vs Power Supply

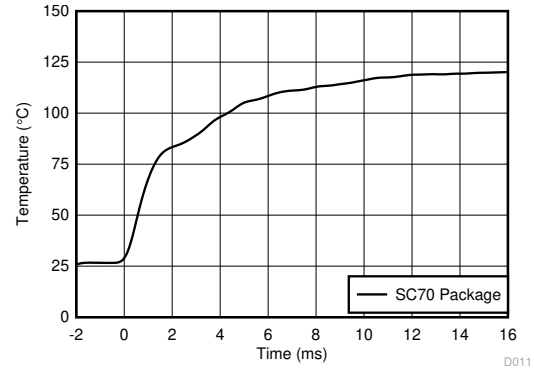

TMP23x-Q1: 1 × 1 (inches) PCB, Air 26°C to Fluid Bath 123°C
Figure 6-8. Thermal Response (Air-to-Fluid Bath)

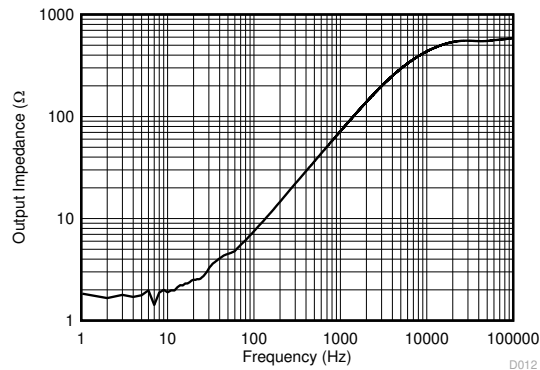

TMP23x-Q1: $T_A = 25^\circ\text{C}$, $V_{DD} = 5\text{ V}$, $I_{OUT} = 100\ \mu\text{A}$
Figure 6-9. Output Impedance vs Frequency

7 Detailed Description

7.1 Overview

The TMP23x-Q1 devices are a family of linear analog temperature sensors with an output voltage proportional to temperature. These temperature sensors have an accuracy from 0°C to 70°C of ±1.5°C. The TMP235-Q1 device provides a positive slope output of 10 mV/°C over the full –40°C to +150°C temperature range and a supply range from 2.3 V to 5.5 V. The higher gain TMP236-Q1 sensor provides a positive slope output of 19.5 mV/°C from –10°C to +125°C and a supply range from 3.1 V to 5.5 V. A class-AB output driver provides a maximum output of 500 µA to drive capacitive loads up to 1000 pF.

7.2 Functional Block Diagram

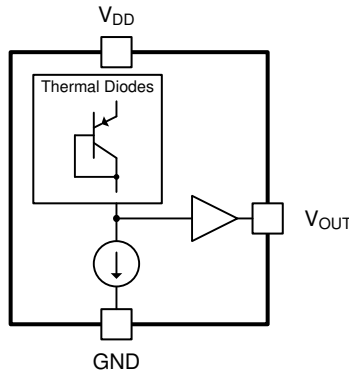

7.3 Feature Description

As shown in [Figure 6-2](#), the TMP23x-Q1 devices are linear. A small V_{OUT} gain shift, however, is present at temperatures above 100°C. When small shifts are expected, a piecewise linear function provides the best accuracy and is used for the device accuracy specifications (see [Specifications](#)). Typical output voltages of the TMP23x-Q1 devices across the full operating temperature range are listed in [Table 7-3](#) and [Table 7-4](#). The ideal linear columns represent the ideal linear V_{OUT} output response with respect to temperature, while the piecewise linear columns indicate the small voltage shift at elevated temperatures.

The piecewise linear function uses three temperature ranges listed in [Table 7-1](#) and [Table 7-2](#). In equation form, the voltage output V_{OUT} of the TMP23x-Q1 is calculated by [Equation 1](#):

$$V_{OUT} = (T_A - T_{INFL}) \times T_C + V_{OFFS} \quad (1)$$

where

- V_{OUT} is the TMP23x-Q1 voltage output for a given temperature
- T_A is the ambient temperature in °C
- T_{INFL} is the temperature inflection point for a piecewise segment in °C
- T_C is the TMP23x-Q1 temperature coefficient or gain
- V_{OFFS} is the TMP23x-Q1 voltage offset

Therefore, the T_A temperature for a given V_{OUT} voltage output within a piecewise voltage range (V_{RANGE}) is calculated in [Equation 2](#). For applications where the accuracy enhancement above 100°C is not required, use the first row of [Table 7-1](#) and [Table 7-2](#) for all voltages.

$$T_A = (V_{OUT} - V_{OFFS}) / T_C + T_{INFL} \quad (2)$$

Table 7-1. TMP235-Q1 Piecewise Linear Function Summary

T_A RANGE (°C)	V_{RANGE} (mV)	T_{INFL} (°C)	T_C (mV/°C)	V_{OFFS} (mV)
–40 to +100	< 1500	0	10	500
100 to 125	1500 to 1752.5	100	10.1	1500
125 to 150	> 1752.5	125	10.6	1752.5

Table 7-2. TMP236-Q1 Piecewise Linear Function Summary

T _A RANGE (°C)	V _{RANGE} (mV)	T _{INFL} (°C)	T _C (mV/°C)	V _{OFFS} (mV)
-40 to +100	≤ 2350	0	19.5	400
100 to 125	> 2350	100	19.7	2350
125 to 150	—	—	—	—

Table 7-3. TMP235-Q1 Transfer Table

TEMPERATURE (°C)	V _{OUT} (mV) IDEAL LINEAR VALUES	V _{OUT} (mV) PIECEWISE LINEAR VALUES
-40	100	100
-35	150	150
-30	200	200
-25	250	250
-20	300	300
-15	350	350
-10	400	400
-5	450	450
0	500	500
5	550	550
10	600	600
15	650	650
20	700	700
25	750	750
30	800	800
35	850	850
40	900	900
45	950	950
50	1000	1000
55	1050	1050
60	1100	1100
65	1150	1150
70	1200	1200
75	1250	1250
80	1300	1300
85	1350	1350
90	1400	1400
95	1450	1450
100	1500	1500
105	1550	1550.5
110	1600	1601
115	1650	1651.5
120	1700	1702
125	1750	1752.5
130	1800	1805.5
135	1850	1858.5
140	1900	1911.5
145	1950	1964.5
150	2000	2017.5

Table 7-4. TMP236-Q1 Transfer Table

TEMPERATURE (°C)	V _{OUT} (mV) IDEAL LINEAR VALUES	V _{OUT} (mV) PIECEWISE LINEAR VALUES
-40	—	—
-35	—	—
-30	—	—
-25	—	—
-20	—	—
-15	—	—
-10	205	205
-5	303	303
0	400	400
5	498	498
10	595	595
15	693	693
20	790	790
25	888	888
30	985	985
35	1083	1083
40	1180	1180
45	1278	1278
50	1375	1375
55	1473	1473
60	1570	1570
65	1668	1668
70	1765	1765
75	1863	1863
80	1960	1960
85	2058	2058
90	2155	2155
95	2253	2253
100	2350	2350
105	2448	2448.5
110	2545	2547
115	2643	2645.4
120	2740	2743.9
125	2838	2842.4
130	—	—
135	—	—
140	—	—
145	—	—
150	—	—

7.4 Device Functional Modes

The singular functional mode of the TMP23x-Q1 is an analog output directly proportional to temperature.

8 Application and Implementation

Note

Information in the following applications sections is not part of the TI component specification, and TI does not warrant its accuracy or completeness. TI's customers are responsible for determining suitability of components for their purposes, as well as validating and testing their design implementation to confirm system functionality.

8.1 Application Information

The features of the TMP235-Q1 make the series of devices designed for various general temperature-sensing applications. The TMP235-Q1 and TMP236-Q1 devices can operate down to a 2.3-V and a 3.1-V supply with 9- μ A power consumption, respectively. The TMP23x-Q1 series is mounted in two surface mount technology packages (SC70 and SOT-23.)

8.2 Typical Application

8.2.1 Connection to an ADC

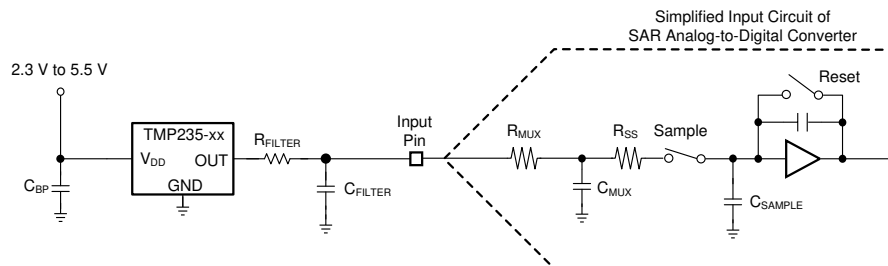

Figure 8-1. Suggested Connections to an ADC Input Stage

8.2.1.1 Design Requirements

See [Figure 8-1](#) for suggested connections to an ADC input stage. Most CMOS-based ADCs have a sampled data comparator input structure. When the ADC charges the sampling capacitor (C_{SAMPLE}), the capacitor requires instantaneous charge from the output of the analog source temperature sensor, such as the TMP235-Q1. Therefore, the output impedance of the temperature sensor can affect ADC performance. In most cases, adding an external capacitor (C_{FILTER}) mitigates design challenges. The TMP235-Q1 is specified and characterized with a 1000-pF maximum capacitive load (C_{LOAD}). [Figure 8-1](#) shows C_{LOAD} as the sum of $C_{FILTER} + C_{MUX} + C_{SAMPLE}$. TI recommends maximizing the C_{FILTER} value while allowing for the maximum specified ADC input capacitance ($C_{MUX} + C_{SAMPLE}$) to limit the total C_{LOAD} at 1000 pF. In most cases, a 680-pF C_{FILTER} provides a reasonable allowance for ADC input capacitance to minimize ADC sampling error and reduce noise coupling. An optional series resistor (R_{FILTER}) and C_{FILTER} provides additional low-pass filtering to reject system level noise. TI recommends placing R_{FILTER} and C_{FILTER} as close as possible to the ADC input for optimal performance.

8.2.1.2 Detailed Design Procedure

Depending on the input characteristics of the ADC, an external C_{FILTER} may be required. The value of C_{FILTER} depends on the size of the sampling capacitor (C_{SAMPLE}) and the sampling frequency while observing a maximum C_{LOAD} of 1000 pF. The capacitor requirements can vary because the input stages of all ADCs are not identical. [Figure 8-1](#) shows a general ADC application as an example only.

8.2.1.3 Application Curve

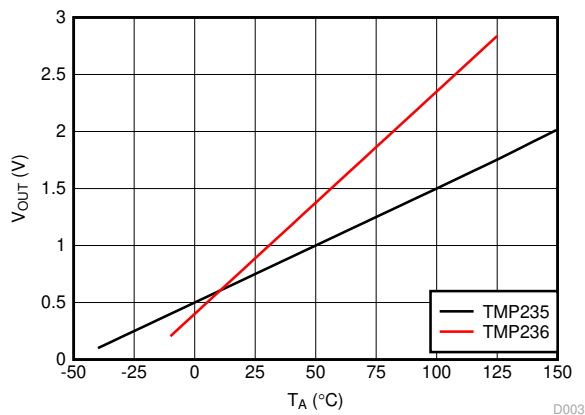

Figure 8-2. Output Voltage vs. Ambient

9 Power Supply Recommendations

The low supply current and supply range of the TMP23x-Q1 allow the device to be easily powered from many sources.



Power supply bypassing is strongly recommended. In noisy environments, TI recommends to add a filter with 0.1- μ F capacitor and 100- Ω resistor between external supply and V_{DD} to limit the power supply noise. Larger capacitances may be required and are dependent on the noise of the power supply.

10 Layout

10.1 Layout Guidelines

The layout of the TMP23x-Q1 series is simple. If a power supply bypass capacitor is used, the capacitor must be connected as [Layout Examples](#) shows.

10.2 Layout Examples

-  VIA to ground plane
-  VIA to power plane

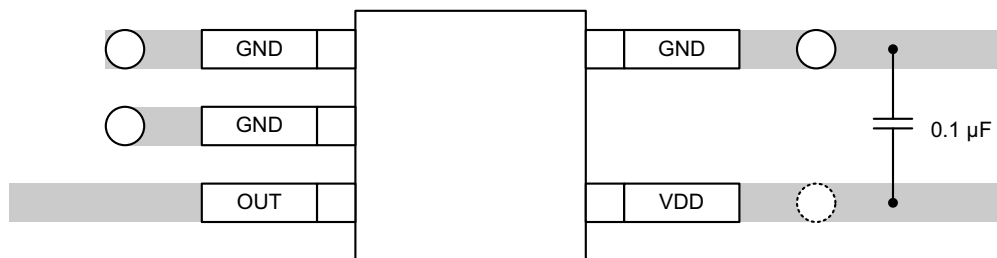

Figure 10-1. Recommended Layout: SC70 Package

11 Device and Documentation Support

11.1 Receiving Notification of Documentation Updates

To receive notification of documentation updates, navigate to the device product folder on ti.com. Click on *Subscribe to updates* to register and receive a weekly digest of any product information that has changed. For change details, review the revision history included in any revised document.

11.2 Support Resources

[TI E2E™ support forums](#) are an engineer's go-to source for fast, verified answers and design help — straight from the experts. Search existing answers or ask your own question to get the quick design help you need.

Linked content is provided "AS IS" by the respective contributors. They do not constitute TI specifications and do not necessarily reflect TI's views; see TI's [Terms of Use](#).

11.3 Trademarks

TI E2E™ is a trademark of Texas Instruments.

All trademarks are the property of their respective owners.

11.4 Electrostatic Discharge Caution



This integrated circuit can be damaged by ESD. Texas Instruments recommends that all integrated circuits be handled with appropriate precautions. Failure to observe proper handling and installation procedures can cause damage.

ESD damage can range from subtle performance degradation to complete device failure. Precision integrated circuits may be more susceptible to damage because very small parametric changes could cause the device not to meet its published specifications.

11.5 Glossary

[TI Glossary](#) This glossary lists and explains terms, acronyms, and definitions.

12 Mechanical, Packaging, and Orderable Information

The following pages include mechanical, packaging, and orderable information. This information is the most current data available for the designated devices. This data is subject to change without notice and revision of this document. For browser-based versions of this data sheet, refer to the left-hand navigation.

PACKAGING INFORMATION

Orderable Device	Status (1)	Package Type	Package Drawing	Pins	Package Qty	Eco Plan (2)	Lead finish/ Ball material (6)	MSL Peak Temp (3)	Op Temp (°C)	Device Marking (4/5)	Samples
TMP235AEDBZRQ1	ACTIVE	SOT-23	DBZ	3	3000	RoHS & Green	NIPDAUAG	Level-2-260C-1 YEAR	-40 to 150	235E	Samples
TMP235AEDBZTQ1	OBSOLETE	SOT-23	DBZ	3		TBD	Call TI	Call TI	-40 to 150	235E	
TMP235AEDCKRQ1	ACTIVE	SC70	DCK	5	3000	RoHS & Green	NIPDAUAG	Level-2-260C-1 YEAR	-40 to 150	1CF	Samples
TMP235AEDCKTQ1	OBSOLETE	SC70	DCK	5		TBD	Call TI	Call TI	-40 to 150	1CF	
TMP235AQDBZRQ1	ACTIVE	SOT-23	DBZ	3	3000	RoHS & Green	NIPDAUAG	Level-2-260C-1 YEAR	-40 to 125	235Q	Samples
TMP235AQDBZTQ1	OBSOLETE	SOT-23	DBZ	3		TBD	Call TI	Call TI	-40 to 125	235Q	
TMP235AQDCKRQ1	ACTIVE	SC70	DCK	5	3000	RoHS & Green	NIPDAUAG	Level-2-260C-1 YEAR	-40 to 125	1CG	Samples
TMP235AQDCKTQ1	OBSOLETE	SC70	DCK	5		TBD	Call TI	Call TI	-40 to 125	1CG	
TMP236AQDBZRQ1	ACTIVE	SOT-23	DBZ	3	3000	RoHS & Green	NIPDAUAG SN	Level-2-260C-1 YEAR	-40 to 125	236Q	Samples
TMP236AQDBZTQ1	OBSOLETE	SOT-23	DBZ	3		TBD	Call TI	Call TI	-40 to 125	236Q	

(1) The marketing status values are defined as follows:

ACTIVE: Product device recommended for new designs.

LIFEBUY: TI has announced that the device will be discontinued, and a lifetime-buy period is in effect.

NRND: Not recommended for new designs. Device is in production to support existing customers, but TI does not recommend using this part in a new design.

PREVIEW: Device has been announced but is not in production. Samples may or may not be available.

OBSOLETE: TI has discontinued the production of the device.

(2) **RoHS:** TI defines "RoHS" to mean semiconductor products that are compliant with the current EU RoHS requirements for all 10 RoHS substances, including the requirement that RoHS substance do not exceed 0.1% by weight in homogeneous materials. Where designed to be soldered at high temperatures, "RoHS" products are suitable for use in specified lead-free processes. TI may reference these types of products as "Pb-Free".

RoHS Exempt: TI defines "RoHS Exempt" to mean products that contain lead but are compliant with EU RoHS pursuant to a specific EU RoHS exemption.

Green: TI defines "Green" to mean the content of Chlorine (Cl) and Bromine (Br) based flame retardants meet JS709B low halogen requirements of <=1000ppm threshold. Antimony trioxide based flame retardants must also meet the <=1000ppm threshold requirement.

(3) MSL, Peak Temp. - The Moisture Sensitivity Level rating according to the JEDEC industry standard classifications, and peak solder temperature.

(4) There may be additional marking, which relates to the logo, the lot trace code information, or the environmental category on the device.

(5) Multiple Device Markings will be inside parentheses. Only one Device Marking contained in parentheses and separated by a "~" will appear on a device. If a line is indented then it is a continuation of the previous line and the two combined represent the entire Device Marking for that device.

(6) Lead finish/Ball material - Orderable Devices may have multiple material finish options. Finish options are separated by a vertical ruled line. Lead finish/Ball material values may wrap to two lines if the finish value exceeds the maximum column width.

Important Information and Disclaimer:The information provided on this page represents TI's knowledge and belief as of the date that it is provided. TI bases its knowledge and belief on information provided by third parties, and makes no representation or warranty as to the accuracy of such information. Efforts are underway to better integrate information from third parties. TI has taken and continues to take reasonable steps to provide representative and accurate information but may not have conducted destructive testing or chemical analysis on incoming materials and chemicals. TI and TI suppliers consider certain information to be proprietary, and thus CAS numbers and other limited information may not be available for release.

In no event shall TI's liability arising out of such information exceed the total purchase price of the TI part(s) at issue in this document sold by TI to Customer on an annual basis.

OTHER QUALIFIED VERSIONS OF TMP235-Q1, TMP236-Q1 :

- Catalog : [TMP235](#), [TMP236](#)

NOTE: Qualified Version Definitions:

- Catalog - TI's standard catalog product

TAPE AND REEL INFORMATION

QUADRANT ASSIGNMENTS FOR PIN 1 ORIENTATION IN TAPE

*All dimensions are nominal

Device	Package Type	Package Drawing	Pins	SPQ	Reel Diameter (mm)	Reel Width W1 (mm)	A0 (mm)	B0 (mm)	K0 (mm)	P1 (mm)	W (mm)	Pin1 Quadrant
TMP235AEDBZRQ1	SOT-23	DBZ	3	3000	180.0	8.4	3.15	2.77	1.22	4.0	8.0	Q3
TMP235AEDCKRQ1	SC70	DCK	5	3000	180.0	8.4	2.47	2.3	1.25	4.0	8.0	Q3
TMP235AQDBZRQ1	SOT-23	DBZ	3	3000	180.0	8.4	3.15	2.77	1.22	4.0	8.0	Q3
TMP235AQDCKRQ1	SC70	DCK	5	3000	180.0	8.4	2.47	2.3	1.25	4.0	8.0	Q3
TMP236AQDBZRQ1	SOT-23	DBZ	3	3000	180.0	8.4	3.15	2.77	1.22	4.0	8.0	Q3

TAPE AND REEL BOX DIMENSIONS



*All dimensions are nominal

Device	Package Type	Package Drawing	Pins	SPQ	Length (mm)	Width (mm)	Height (mm)
TMP235AEDBZRQ1	SOT-23	DBZ	3	3000	213.0	191.0	35.0
TMP235AEDCKRQ1	SC70	DCK	5	3000	213.0	191.0	35.0
TMP235AQDBZRQ1	SOT-23	DBZ	3	3000	213.0	191.0	35.0
TMP235AQDCKRQ1	SC70	DCK	5	3000	213.0	191.0	35.0
TMP236AQDBZRQ1	SOT-23	DBZ	3	3000	213.0	191.0	35.0

EXAMPLE BOARD LAYOUT

DCK0005A

SOT - 1.1 max height

SMALL OUTLINE TRANSISTOR



LAND PATTERN EXAMPLE
EXPOSED METAL SHOWN
SCALE:18X



SOLDER MASK DETAILS

4214834/E 06/2024

NOTES: (continued)

- 7. Publication IPC-7351 may have alternate designs.
- 8. Solder mask tolerances between and around signal pads can vary based on board fabrication site.

EXAMPLE STENCIL DESIGN

DCK0005A

SOT - 1.1 max height

SMALL OUTLINE TRANSISTOR

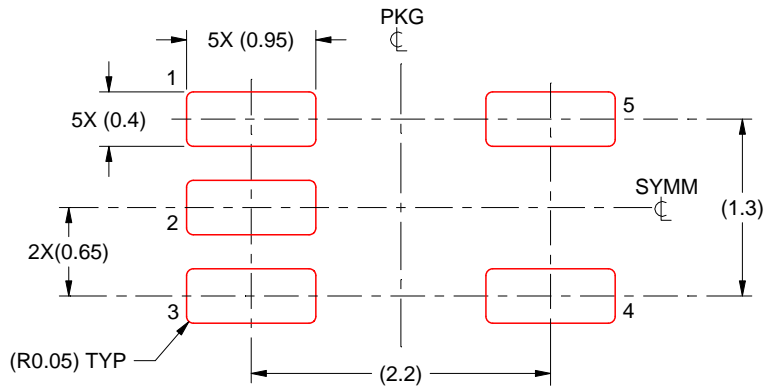

SOLDER PASTE EXAMPLE
BASED ON 0.125 THICK STENCIL
SCALE: 18X

4214834/E 06/2024

NOTES: (continued)

9. Laser cutting apertures with trapezoidal walls and rounded corners may offer better paste release. IPC-7525 may have alternate design recommendations.
10. Board assembly site may have different recommendations for stencil design.

EXAMPLE BOARD LAYOUT

DBZ0003A

SOT-23 - 1.12 mm max height

SMALL OUTLINE TRANSISTOR

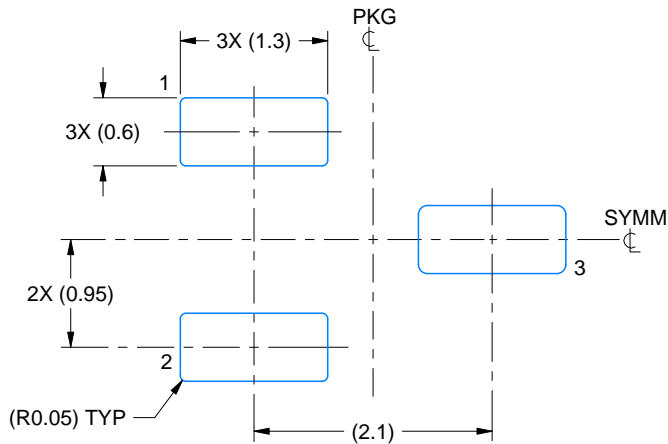

LAND PATTERN EXAMPLE
SCALE:15X

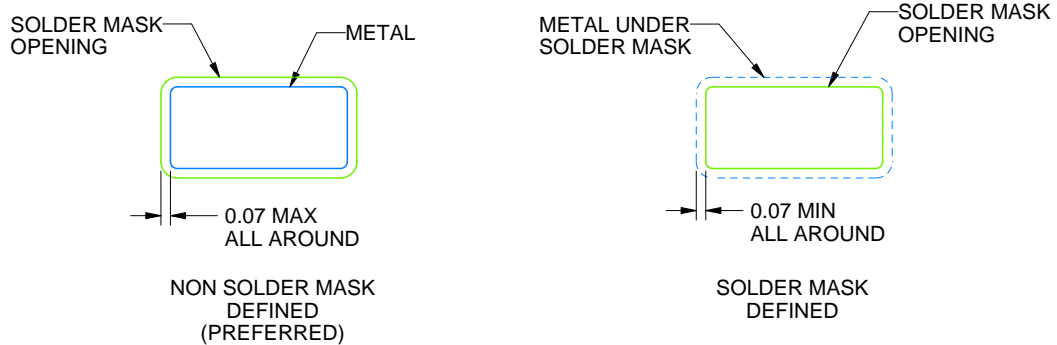

SOLDER MASK DETAILS

4214838/F 08/2024

NOTES: (continued)

- 5. Publication IPC-7351 may have alternate designs.
- 6. Solder mask tolerances between and around signal pads can vary based on board fabrication site.

EXAMPLE STENCIL DESIGN

DBZ0003A

SOT-23 - 1.12 mm max height

SMALL OUTLINE TRANSISTOR

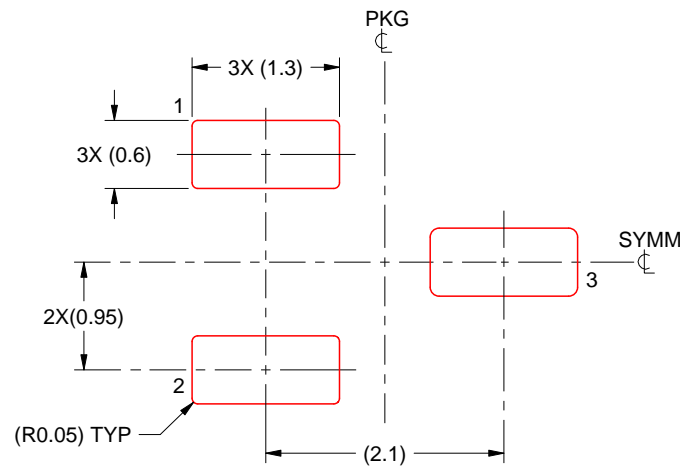

SOLDER PASTE EXAMPLE
BASED ON 0.125 THICK STENCIL
SCALE:15X

4214838/F 08/2024

NOTES: (continued)

7. Laser cutting apertures with trapezoidal walls and rounded corners may offer better paste release. IPC-7525 may have alternate design recommendations.
8. Board assembly site may have different recommendations for stencil design.

IMPORTANT NOTICE AND DISCLAIMER

TI PROVIDES TECHNICAL AND RELIABILITY DATA (INCLUDING DATA SHEETS), DESIGN RESOURCES (INCLUDING REFERENCE DESIGNS), APPLICATION OR OTHER DESIGN ADVICE, WEB TOOLS, SAFETY INFORMATION, AND OTHER RESOURCES "AS IS" AND WITH ALL FAULTS, AND DISCLAIMS ALL WARRANTIES, EXPRESS AND IMPLIED, INCLUDING WITHOUT LIMITATION ANY IMPLIED WARRANTIES OF MERCHANTABILITY, FITNESS FOR A PARTICULAR PURPOSE OR NON-INFRINGEMENT OF THIRD PARTY INTELLECTUAL PROPERTY RIGHTS.

These resources are intended for skilled developers designing with TI products. You are solely responsible for (1) selecting the appropriate TI products for your application, (2) designing, validating and testing your application, and (3) ensuring your application meets applicable standards, and any other safety, security, regulatory or other requirements.

These resources are subject to change without notice. TI grants you permission to use these resources only for development of an application that uses the TI products described in the resource. Other reproduction and display of these resources is prohibited. No license is granted to any other TI intellectual property right or to any third party intellectual property right. TI disclaims responsibility for, and you will fully indemnify TI and its representatives against, any claims, damages, costs, losses, and liabilities arising out of your use of these resources.

TI's products are provided subject to [TI's Terms of Sale](#) or other applicable terms available either on [ti.com](https://www.ti.com) or provided in conjunction with such TI products. TI's provision of these resources does not expand or otherwise alter TI's applicable warranties or warranty disclaimers for TI products.

TI objects to and rejects any additional or different terms you may have proposed.

Mailing Address: Texas Instruments, Post Office Box 655303, Dallas, Texas 75265
Copyright © 2024, Texas Instruments Incorporated