

TLV905x-Q1 Automotive 5MHz, 15V/μs High Slew-Rate, RRIO, CMOS Op Amp

1 Features

- AEC-Q100 qualified for automotive applications:
 - Temperature: –40°C to 125°C, T_A
- High slew rate: 15V/μs
- Low quiescent current: 330μA
- Rail-to-rail input and output
- Low input offset voltage: ±0.33mV
- Unity-gain bandwidth: 5MHz
- Low broadband noise: 15nV/√Hz
- Low input bias current: 2pA
- Unity-gain stable
- Internal RFI and EMI filter
- Scalable family of CMOS op amps for low-cost applications
- Operational at supply voltages as low as 1.8V

2 Applications

- Optimized for AEC-Q100 grade 1 applications
- [HEV/EV traction inverter and motor control](#)
- [HEV/EV DC/DC converter](#)
- [HEV/EV battery-management system \(BMS\)](#)
- [On-board \(OBC\) and wireless charger](#)
- [Automotive body motors](#)
- [Automotive heating and cooling](#)

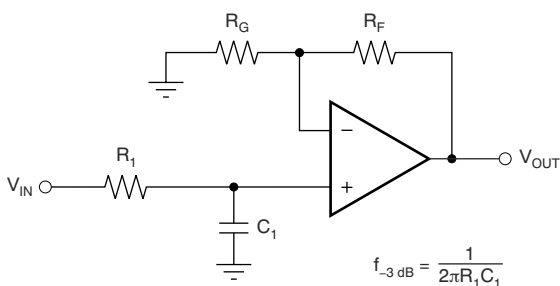

$$\frac{V_{OUT}}{V_{IN}} = \left(1 + \frac{R_F}{R_G}\right) \left(\frac{1}{1 + sR_1C_1}\right)$$

Single-Pole, Low-Pass Filter

3 Description

The TLV9051-Q1, TLV9052-Q1, and TLV9054-Q1 devices are single, dual, and quad operational amplifiers, respectively. The devices are designed for low voltage operation from 1.8V to 6.0V. The inputs and outputs can operate from rail to rail at a very high slew rate. These devices are an excellent choice for cost-constrained applications where low-voltage operation, high slew rate, and low quiescent current is needed. The capacitive-load drive of the TLV905x-Q1 family is 150pF, and the resistive open-loop output impedance makes stabilization easier with much higher capacitive loads.

The TLV905x-Q1 family is easy to use due to the devices being unity-gain stable, including a RFI and EMI filter, and being free from phase reversal in an overdrive condition.

Device Information

| PART NUMBER ⁽¹⁾ | CHANNEL COUNT | PACKAGE | PACKAGE SIZE ⁽⁴⁾ |
|----------------------------|---------------|-------------------------------|-----------------------------|
| TLV9051-Q1 | Single | DBV (SOT-23, 5) | 2.90mm × 2.80mm |
| | | DCK (SC70, 5) ⁽³⁾ | 2.00mm × 2.10mm |
| TLV9052-Q1 | Dual | D (SOIC, 8) ⁽³⁾ | 4.90mm × 6.00mm |
| | | PW (TSSOP, 8) | 3.00mm × 6.40mm |
| | | DGK (VSSOP, 8) ⁽³⁾ | 3.00mm × 4.90mm |
| TLV9054-Q1 ⁽²⁾ | Quad | D (SOIC, 14) ⁽³⁾ | 8.65mm × 6.00mm |
| | | PW (TSSOP, 14) ⁽³⁾ | 5.00mm × 6.40mm |

- (1) For more information, see [Section 10](#)
- (2) This device is for preview only.
- (3) This package is for preview only.
- (4) The package size (length x width) is a nominal value and includes pins, where applicable.

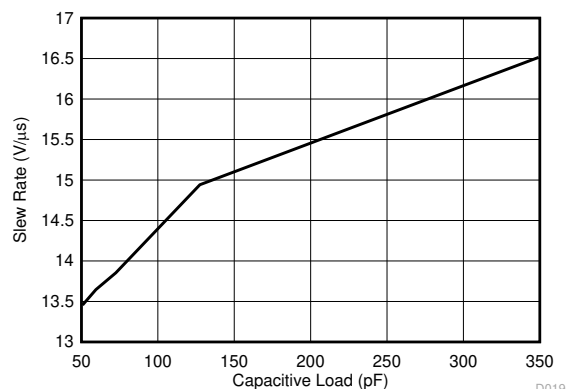

Slew Rate vs Load Capacitance

D019



Table of Contents

| | | | |
|---------------------------------------------------------------------------------------------------|----|----------------------------------------------------------------------|----|
| 1 Features | 1 | 6.4 Device Functional Modes..... | 20 |
| 2 Applications | 1 | 7 Application and Implementation | 21 |
| 3 Description | 1 | 7.1 Application Information..... | 21 |
| 4 Pin Configuration and Functions | 3 | 7.2 Typical Low-Side Current Sense Application..... | 21 |
| 5 Specifications | 6 | 7.3 Power Supply Recommendations..... | 23 |
| 5.1 Absolute Maximum Ratings..... | 6 | 7.4 Layout..... | 23 |
| 5.2 ESD Ratings..... | 6 | 8 Device and Documentation Support | 25 |
| 5.3 Recommended Operating Conditions..... | 6 | 8.1 Device Support..... | 25 |
| 5.4 Thermal Information for Single Channel..... | 7 | 8.2 Documentation Support..... | 25 |
| 5.5 Thermal Information for Dual Channel..... | 7 | 8.3 Receiving Notification of Documentation Updates.... | 25 |
| 5.6 Thermal Information for Quad Channel..... | 7 | 8.4 Support Resources..... | 25 |
| 5.7 Electrical Characteristics: V_S (Total Supply Voltage) = (V+) – (V–) = 1.8V to 5.5V..... | 8 | 8.5 Trademarks..... | 25 |
| 5.8 Typical Characteristics..... | 10 | 8.6 Electrostatic Discharge Caution..... | 25 |
| 6 Detailed Description | 17 | 8.7 Glossary..... | 25 |
| 6.1 Overview..... | 17 | 9 Revision History | 26 |
| 6.2 Functional Block Diagram..... | 17 | 10 Mechanical, Packaging, and Orderable Information | 26 |
| 6.3 Feature Description..... | 18 | | |

4 Pin Configuration and Functions

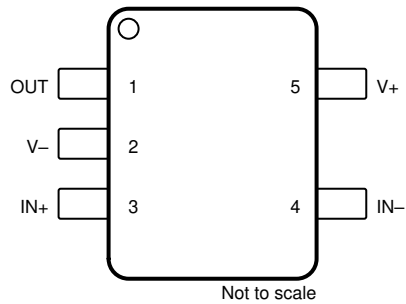

**Figure 4-1. TLV9051-Q1 DBV Package,
5-Pin SOT-23
(Top View)**

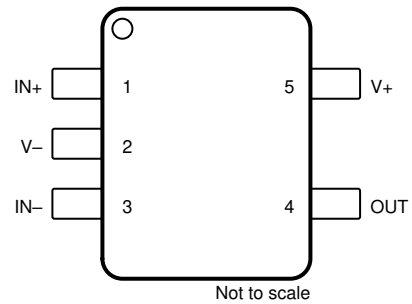
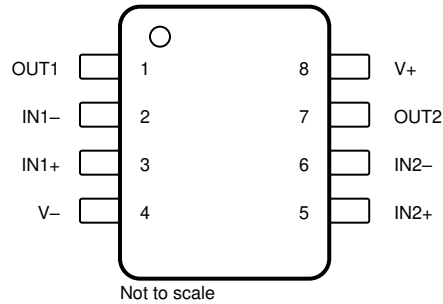

**Figure 4-2. TLV9051-Q1 DCK Package,
5-Pin SC70
(Top View)**

Table 4-1. Pin Functions: TLV9051-Q1

| NAME | PIN | | TYPE ⁽¹⁾ | DESCRIPTION |
|------|--------|-------|---------------------|---------------------------------------------------------------|
| | SOT-23 | SC-70 | | |
| IN- | 4 | 3 | I | Inverting input |
| IN+ | 3 | 1 | I | Noninverting input |
| OUT | 1 | 4 | O | Output |
| V- | 2 | 2 | — | Negative (low) supply or ground (for single-supply operation) |
| V+ | 5 | 5 | — | Positive (high) supply |

(1) I = input, O = output

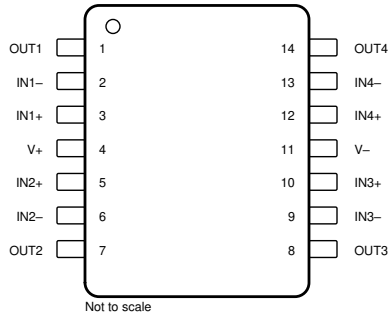

**Figure 4-3. TLV9052-Q1 D, DGK, PW Packages,
8-Pin SOIC, VSSOP, TSSOP
(Top View)**

Table 4-2. Pin Functions: TLV9052-Q1

| PIN | | TYPE ⁽¹⁾ | DESCRIPTION |
|------|-----|---------------------|---------------------------------------------------------------|
| NAME | NO. | | |
| IN1- | 2 | I | Inverting input, channel 1 |
| IN1+ | 3 | I | Noninverting input, channel 1 |
| IN2- | 6 | I | Inverting input, channel 2 |
| IN2+ | 5 | I | Noninverting input, channel 2 |
| OUT1 | 1 | O | Output, channel 1 |
| OUT2 | 7 | O | Output, channel 2 |
| V- | 4 | — | Negative (low) supply or ground (for single-supply operation) |
| V+ | 8 | — | Positive (high) supply |

(1) I = input, O = output



**Figure 4-4. TLV9054-Q1 D, PW Packages,
14-Pin SOIC, TSSOP
(Top View)**

Table 4-3. Pin Functions: TLV9054-Q1

| PIN | | TYPE ⁽¹⁾ | DESCRIPTION |
|------|-----|---------------------|---------------------------------------------------------------|
| NAME | NO. | | |
| IN1- | 2 | I | Inverting input, channel 1 |
| IN1+ | 3 | I | Noninverting input, channel 1 |
| IN2- | 6 | I | Inverting input, channel 2 |
| IN2+ | 5 | I | Noninverting input, channel 2 |
| IN3- | 9 | I | Inverting input, channel 3 |
| IN3+ | 10 | I | Noninverting input, channel 3 |
| IN4- | 13 | I | Inverting input, channel 4 |
| IN4+ | 12 | I | Noninverting input, channel 4 |
| OUT1 | 1 | O | Output, channel 1 |
| OUT2 | 7 | O | Output, channel 2 |
| OUT3 | 8 | O | Output, channel 3 |
| OUT4 | 14 | O | Output, channel 4 |
| V- | 11 | — | Negative (low) supply or ground (for single-supply operation) |
| V+ | 4 | — | Positive (high) supply |

(1) I = input, O = output

5 Specifications

5.1 Absolute Maximum Ratings

over operating free-air temperature (unless otherwise noted)⁽¹⁾

| | | | MIN | MAX | UNIT |
|-------------------------------------|---------------------------|-----------------------------|---------------------------------------------|-------------------------|------|
| Supply voltage | | | | 7 | V |
| Signal input pins | Voltage ⁽²⁾ | Common-mode | (V ₋) - 0.5 | (V ₊) + 0.5 | V |
| | | Differential ⁽⁴⁾ | (V ₊) - (V ₋) + 0.2 | | |
| Current ⁽²⁾ | | | -10 | 10 | mA |
| Output short-circuit ⁽³⁾ | | | Continuous | | mA |
| Temperature | Specified, T _A | | -40 | 125 | °C |
| | Junction, T _J | | | 150 | |
| | Storage, T _{stg} | | -65 | 150 | |

- (1) Operation outside the Absolute Maximum Ratings may cause permanent device damage. Absolute Maximum Ratings do not imply functional operation of the device at these or any other conditions beyond those listed under Recommended Operating Conditions. If used outside the Recommended Operating Conditions but within the Absolute Maximum Ratings, the device may not be fully functional, and this may affect device reliability, functionality, performance, and shorten the device lifetime.
- (2) Input pins are diode-clamped to the power-supply rails. Current limit input signals that can swing more than 0.5V beyond the supply rails to 10mA or less.
- (3) Short-circuit to ground, one amplifier per package.
- (4) Differential input voltages greater than 0.5 V applied continuously can result in a shift to the input offset voltage and quiescent current above the maximum specifications of these parameters. The magnitude of this effect increases as the ambient operating temperature rises.

5.2 ESD Ratings

over operating free-air temperature range (unless otherwise noted)

| | | | VALUE | UNIT |
|-------------------------------------------|-------------------------|---------------------------------------------------------|-------|------|
| V _(ESD) - Other Packages | Electrostatic discharge | Human body model (HBM), per AEC-Q100-002 ⁽¹⁾ | ±4000 | V |
| | | Charged device model (CDM), per AEC-Q100-001 | ±1500 | |

- (1) AEC Q100-002 indicates HBM stressing is done in accordance with the ANSI/ESDA/JEDEC JS-001 specification.

5.3 Recommended Operating Conditions

over operating free-air temperature range (unless otherwise noted)

| | | MIN | MAX | UNIT |
|----------------|---------------------------|-------------------------|-------------------------|------|
| V _S | Supply voltage | 1.8 | 6 | V |
| V _I | Common mode voltage range | (V ₋) - 0.1 | (V ₊) + 0.1 | V |
| T _A | Specified temperature | -40 | 125 | °C |

5.4 Thermal Information for Single Channel

| THERMAL METRIC ⁽¹⁾ | | TLV9051-Q1 | | UNIT |
|-------------------------------|----------------------------------------------|-----------------|---------------|------|
| | | DBV (SOT-23) | DCK (SC70) | |
| | | 5 PINS | 5 PINS | |
| R _{θJA} | Junction-to-ambient thermal resistance | 232.5 | TBD | °C/W |
| R _{θJC(top)} | Junction-to-case (top) thermal resistance | 131.0 | TBD | °C/W |
| R _{θJB} | Junction-to-board thermal resistance | 99.6 | TBD | °C/W |
| ψ _{JT} | Junction-to-top characterization parameter | 66.5 | TBD | °C/W |
| ψ _{JB} | Junction-to-board characterization parameter | 99.1 | TBD | °C/W |
| R _{θJC(bot)} | Junction-to-case (bottom) thermal resistance | N/A | N/A | °C/W |

- (1) For more information about traditional and new thermal metrics, see the [Semiconductor and IC Package Thermal Metrics](#) application note.

5.5 Thermal Information for Dual Channel

| THERMAL METRIC ⁽¹⁾ | | TLV9052-Q1 | | | UNIT |
|-------------------------------|----------------------------------------------|-------------|----------------|---------------|------|
| | | D (SOIC) | DGK (VSSOP) | PW (TSSOP) | |
| | | 8 PINS | 8 PINS | 8 PINS | |
| R _{θJA} | Junction-to-ambient thermal resistance | TBD | TBD | 180.5 | °C/W |
| R _{θJC(top)} | Junction-to-case (top) thermal resistance | TBD | TBD | 85.2 | °C/W |
| R _{θJB} | Junction-to-board thermal resistance | TBD | TBD | 120.7 | °C/W |
| ψ _{JT} | Junction-to-top characterization parameter | TBD | TBD | 15.7 | °C/W |
| ψ _{JB} | Junction-to-board characterization parameter | TBD | TBD | 118.1 | °C/W |
| R _{θJC(bot)} | Junction-to-case (bottom) thermal resistance | N/A | N/A | N/A | °C/W |

- (1) For more information about traditional and new thermal metrics, see the [Semiconductor and IC Package Thermal Metrics](#) application note.

5.6 Thermal Information for Quad Channel

| THERMAL METRIC ⁽¹⁾ | | TLV9054-Q1 | | UNIT |
|-------------------------------|----------------------------------------------|-------------|---------------|------|
| | | D (SOIC) | PW (TSSOP) | |
| | | 14 PINS | 14 PINS | |
| R _{θJA} | Junction-to-ambient thermal resistance | TBD | TBD | °C/W |
| R _{θJC(top)} | Junction-to-case (top) thermal resistance | TBD | TBD | °C/W |
| R _{θJB} | Junction-to-board thermal resistance | TBD | TBD | °C/W |
| ψ _{JT} | Junction-to-top characterization parameter | TBD | TBD | °C/W |
| ψ _{JB} | Junction-to-board characterization parameter | TBD | TBD | °C/W |
| R _{θJC(bot)} | Junction-to-case (bottom) thermal resistance | N/A | N/A | °C/W |

- (1) For more information about traditional and new thermal metrics, see the [Semiconductor and IC Package Thermal Metrics](#) application note.

5.7 Electrical Characteristics: V_S (Total Supply Voltage) = $(V_+) - (V_-) = 1.8V$ to $5.5V$

at $T_A = 25^\circ C$, $R_L = 10k\Omega$ connected to $V_S / 2$, $V_{CM} = V_S / 2$, and $V_{OUT} = V_S / 2$ (unless otherwise noted);

| PARAMETER | | TEST CONDITIONS | MIN | TYP | MAX | UNIT |
|----------------------------|--------------------------------------------------|--------------------------------------------------------------------------------------------------|---------------|------------|----------------|------------------|
| OFFSET VOLTAGE | | | | | | |
| V_{OS} | Input offset voltage | $V_S = 5V$ | | ± 0.33 | ± 1.85 | mV |
| | | $V_S = 5V$, $T_A = -40^\circ C$ to $+125^\circ C$ | | | ± 2.24 | |
| dV_{OS}/dT | Drift | $V_S = 5V$, $T_A = -40^\circ C$ to $+125^\circ C$ | | ± 0.5 | | $\mu V/^\circ C$ |
| PSRR | Power-supply rejection ratio | $V_S = 1.8V - 5.5V$, $V_{CM} = (V_-)$ | | ± 13 | ± 80 | $\mu V/V$ |
| | Channel separation, dc | At dc | | 115 | | dB |
| INPUT VOLTAGE RANGE | | | | | | |
| V_{CM} | Common-mode voltage | $V_S = 1.8V$ to $5.5V$ | $(V_-) - 0.1$ | | $(V_+) + 0.1$ | V |
| CMRR | Common-mode rejection ratio | $V_S = 5.5V$, $(V_-) - 0.1V < V_{CM} < (V_+) - 1.4V$, $T_A = -40^\circ C$ to $+125^\circ C$ | 80 | 96 | | dB |
| | | $V_S = 5.5V$, $V_{CM} = -0.1V$ to $5.6V$, $T_A = -40^\circ C$ to $+125^\circ C$ | 62 | 79 | | |
| | | $V_S = 1.8V$, $(V_-) - 0.1V < V_{CM} < (V_+) - 1.4V$, $T_A = -40^\circ C$ to $+125^\circ C$ | | 88 | | |
| | | $V_S = 1.8V$, $V_{CM} = -0.1V$ to $1.9V$, $T_A = -40^\circ C$ to $+125^\circ C$ | | 72 | | |
| INPUT BIAS CURRENT | | | | | | |
| I_B | Input bias current | | | ± 2 | $\pm 18^{(2)}$ | pA |
| | | $T_A = -40^\circ C$ to $+125^\circ C$ | | | | $\pm 750^{(2)}$ |
| I_{OS} | Input offset current | | | ± 1 | $\pm 15^{(2)}$ | pA |
| | | $T_A = -40^\circ C$ to $+125^\circ C$ | | | | $\pm 440^{(2)}$ |
| NOISE | | | | | | |
| E_n | Input voltage noise (peak-to-peak) | $V_S = 5V$, $f = 0.1Hz$ to $10Hz$ | | 6 | | μV_{PP} |
| e_n | Input voltage noise density | $V_S = 5V$, $f = 10kHz$ | | 15 | | nV/\sqrt{Hz} |
| | | $V_S = 5V$, $f = 1kHz$ | | 20 | | nV/\sqrt{Hz} |
| i_n | Input current noise density | $f = 1kHz$ | | 18 | | fA/\sqrt{Hz} |
| INPUT CAPACITANCE | | | | | | |
| C_{ID} | Differential | | | 2 | | pF |
| C_{IC} | Common-mode | | | 4 | | pF |
| OPEN-LOOP GAIN | | | | | | |
| A_{OL} | Open-loop voltage gain | $V_S = 1.8V$, $(V_-) + 0.04V < V_O < (V_+) - 0.04V$, $R_L = 10k\Omega$ | | 106 | | dB |
| | | $V_S = 5.5V$, $(V_-) + 0.05V < V_O < (V_+) - 0.05V$, $R_L = 10k\Omega$ | 104 | 128 | | |
| | | $V_S = 1.8V$, $(V_-) + 0.06V < V_O < (V_+) - 0.06V$, $R_L = 2k\Omega$ | | 108 | | |
| | | $V_S = 5.5V$, $(V_-) + 0.15V < V_O < (V_+) - 0.15V$, $R_L = 2k\Omega$ | | 130 | | |
| FREQUENCY RESPONSE | | | | | | |
| GBP | Gain bandwidth product | $V_S = 5.5V$, $G = +1$ | | 5 | | MHz |
| ϕ_m | Phase margin | $V_S = 5.5V$, $G = +1$ | | 60 | | Degrees |
| SR | Slew rate | $V_S = 5.5V$, $G = +1$, $C_L = 130pF$ | | 15 | | V/ μs |
| t_s | Settling time | To 0.1%, $V_S = 5.5V$, 2V step, $G = +1$, $C_L = 100pF$ | | 0.75 | | μs |
| | | To 0.01%, $V_S = 5.5V$, 2V step, $G = +1$, $C_L = 100pF$ | | 1 | | |
| t_{OR} | Overload recovery time | $V_S = 5.5V$, $V_{IN} \times \text{gain} > V_S$ | | 0.3 | | μs |
| THD + N | Total harmonic distortion + noise ⁽¹⁾ | $V_S = 5.5V$, $V_{CM} = 2.5V$, $V_O = 1V_{RMS}$, $G = +1$, $f = 1kHz$ | | 0.0006% | | |
| OUTPUT | | | | | | |
| V_O | Voltage output swing from supply rails | $V_S = 5.5V$, $R_L = 10k\Omega$, | | | 16 | mV |
| | | $V_S = 5.5V$, $R_L = 2k\Omega$, | | | 40 | |

5.7 Electrical Characteristics: V_S (Total Supply Voltage) = (V+) – (V–) = 1.8V to 5.5V (continued)

at $T_A = 25^\circ\text{C}$, $R_L = 10\text{k}\Omega$ connected to $V_S / 2$, $V_{CM} = V_S / 2$, and $V_{OUT} = V_S / 2$ (unless otherwise noted);

| PARAMETER | | TEST CONDITIONS | MIN | TYP | MAX | UNIT |
|---------------------|---------------------------------|----------------------------------------------------------------------------------------------|-----|----------|-----|---------------|
| I_{SC} | Short-circuit current | $V_S = 5\text{V}$ | | ± 50 | | mA |
| Z_O | Open-loop output impedance | $V_S = 5\text{V}$, $f = 5\text{MHz}$ | | 250 | | Ω |
| POWER SUPPLY | | | | | | |
| I_Q | Quiescent current per amplifier | $V_S = 5.5\text{V}$, $I_O = 0\text{mA}$, | | 330 | 450 | μA |
| | | $V_S = 5.5\text{V}$, $I_O = 0\text{mA}$, $T_A = -40^\circ\text{C}$ to $+125^\circ\text{C}$ | | | 475 | |

- (1) Third-order filter; bandwidth = 80kHz at –3dB.
- (2) Specified by design and characterization; not production tested.

5.8 Typical Characteristics

at $T_A = 25^\circ\text{C}$, $V_S = 5.5\text{V}$, $R_L = 10\text{k}\Omega$ connected to $V_S / 2$, $V_{CM} = V_S / 2$, and $V_{OUT} = V_S / 2$ (unless otherwise noted)

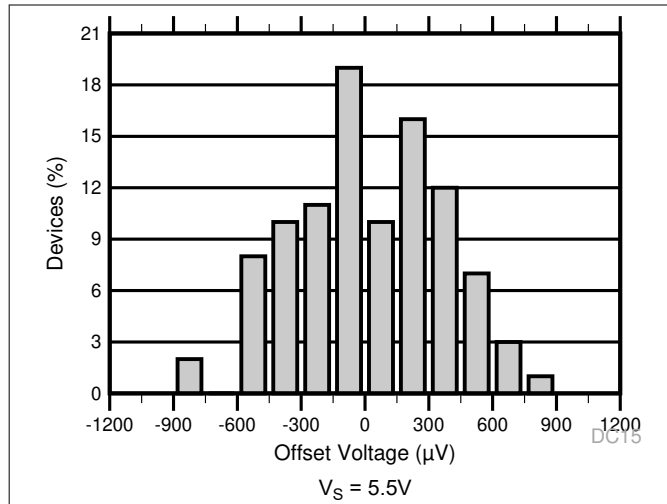

Figure 5-1. Offset Voltage Production Distribution

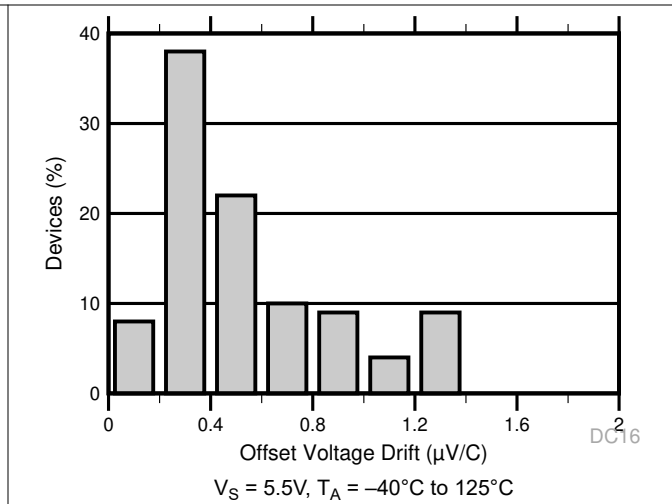

Figure 5-2. Offset Voltage Drift Distribution

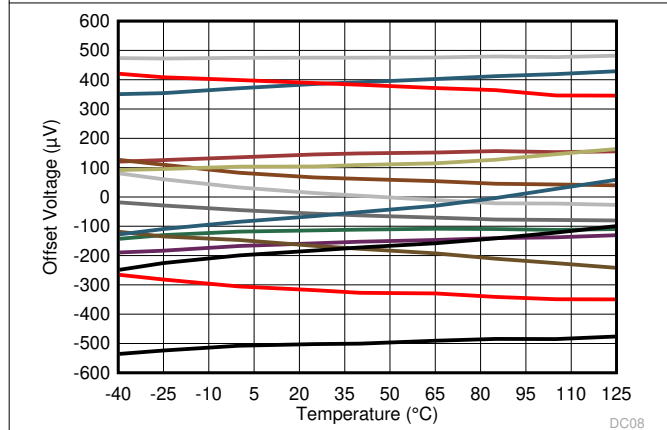

Figure 5-3. Offset Voltage vs Temperature

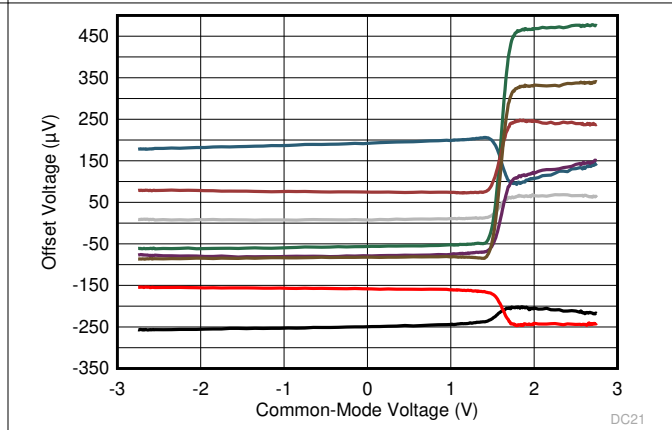

Figure 5-4. Offset Voltage vs Common-Mode Voltage

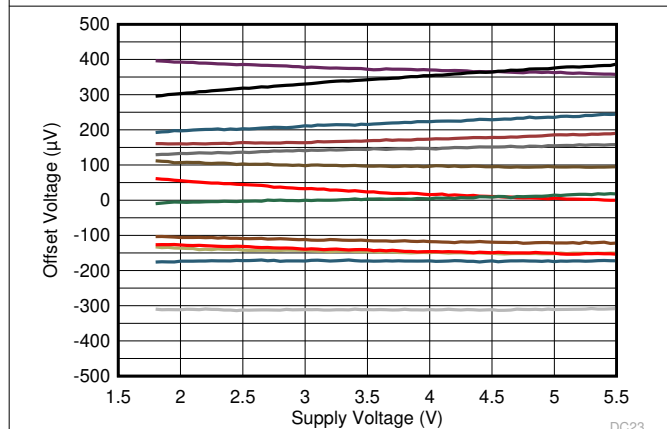

Figure 5-5. Offset Voltage vs Power Supply

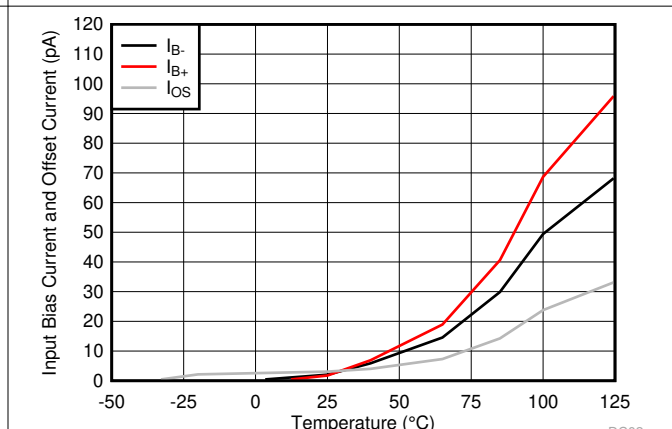

Figure 5-6. Input Bias Current vs Temperature

5.8 Typical Characteristics (continued)

at $T_A = 25^\circ\text{C}$, $V_S = 5.5\text{V}$, $R_L = 10\text{k}\Omega$ connected to $V_S / 2$, $V_{CM} = V_S / 2$, and $V_{OUT} = V_S / 2$ (unless otherwise noted)

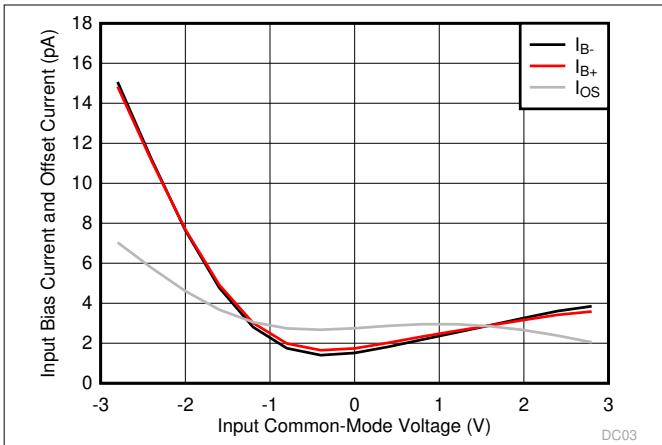

Figure 5-7. Input Bias Current and Offset Current vs Common-Mode Voltage

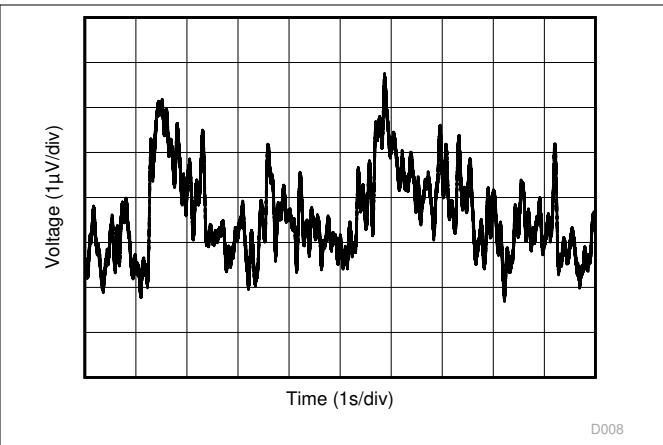

Figure 5-8. 0.1Hz to 10Hz Input Voltage Noise

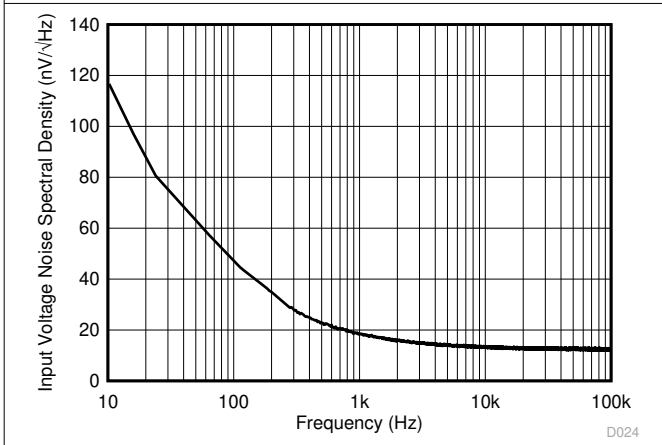

Figure 5-9. Input Voltage Noise Spectral Density vs Frequency

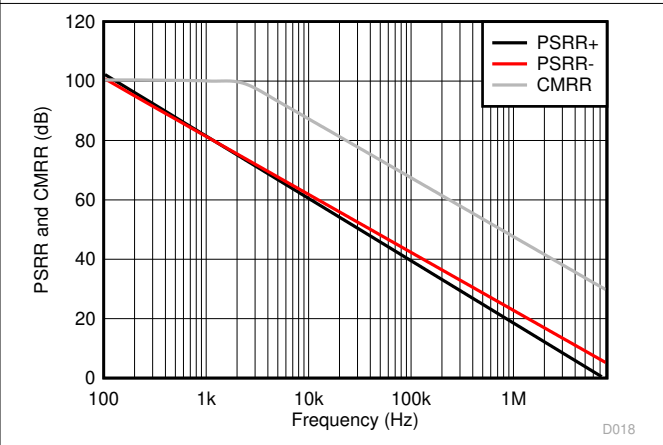

Figure 5-10. CMRR and PSRR vs Frequency (Referred to Input)

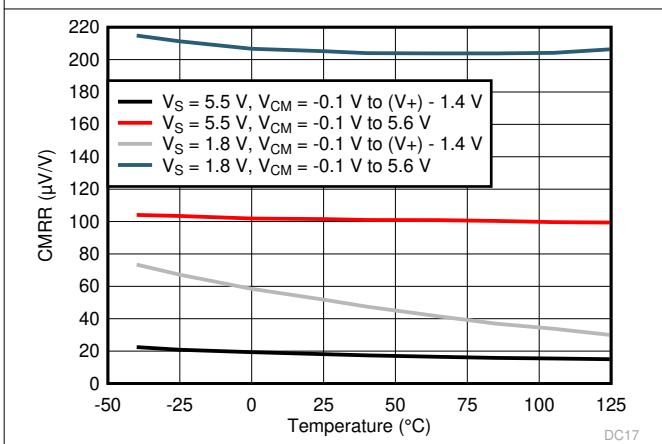

Figure 5-11. CMRR vs Temperature

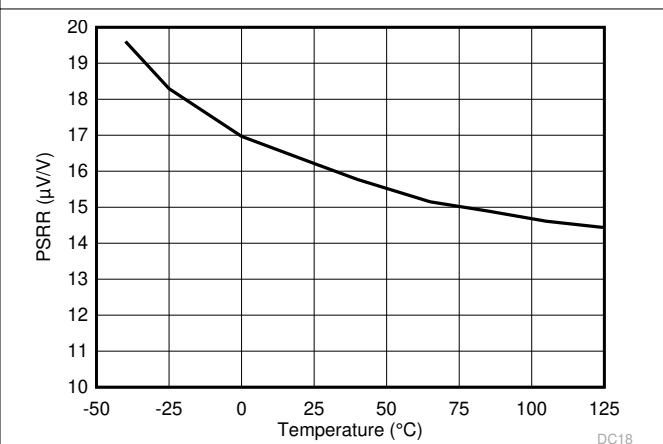

Figure 5-12. PSRR vs Temperature

5.8 Typical Characteristics (continued)

at $T_A = 25^\circ\text{C}$, $V_S = 5.5\text{V}$, $R_L = 10\text{k}\Omega$ connected to $V_S / 2$, $V_{CM} = V_S / 2$, and $V_{OUT} = V_S / 2$ (unless otherwise noted)

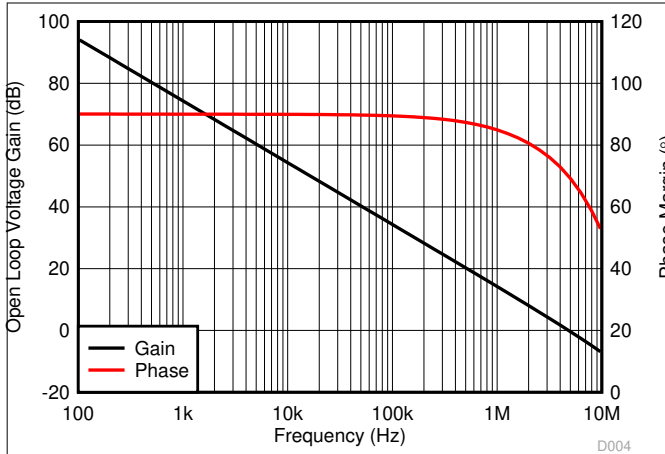

Figure 5-13. Open Loop Voltage Gain and Phase vs Frequency

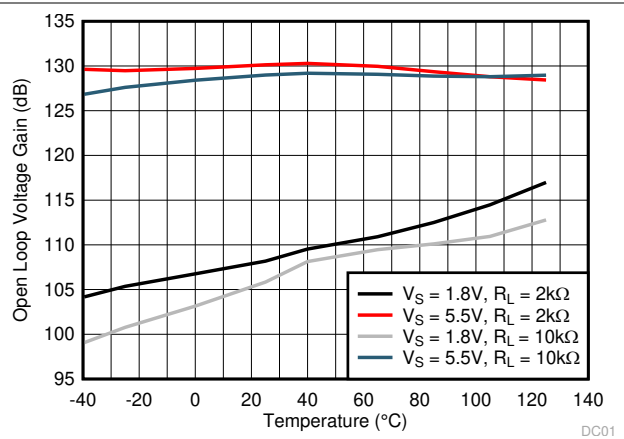

Figure 5-14. Open Loop Voltage Gain vs Temperature

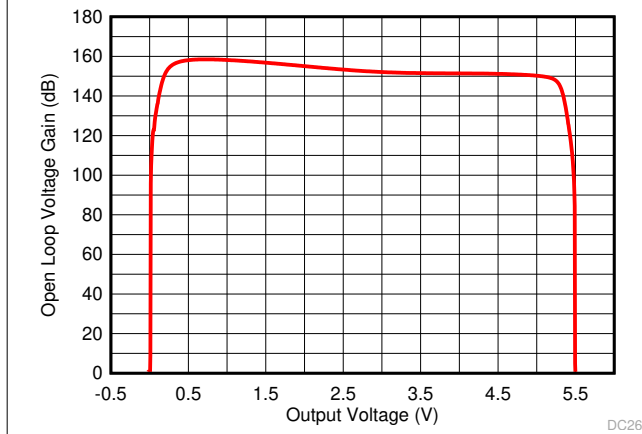

Figure 5-15. Open Loop Voltage Gain vs Output Voltage

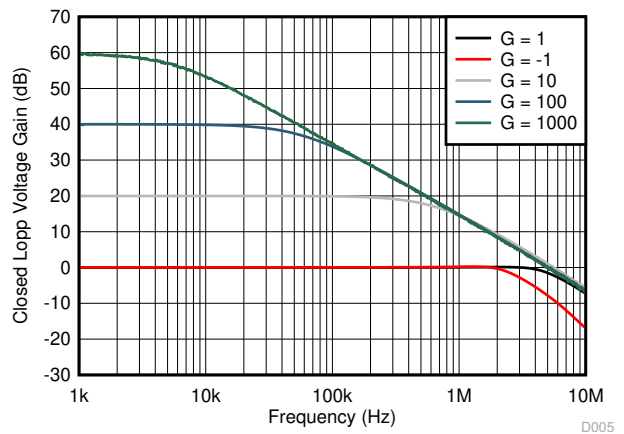

Figure 5-16. Closed Loop Voltage Gain vs Frequency

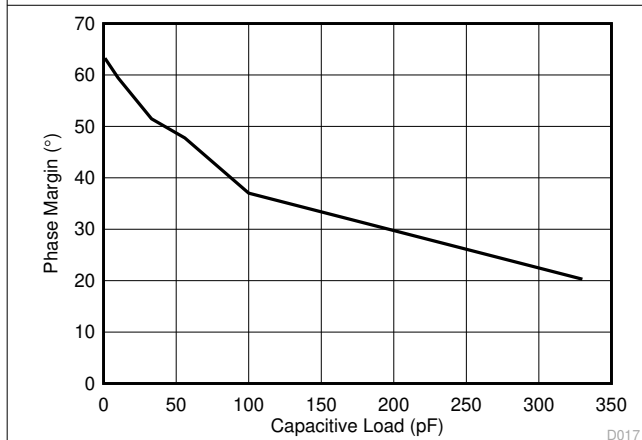

Figure 5-17. Phase Margin vs Capacitive Load

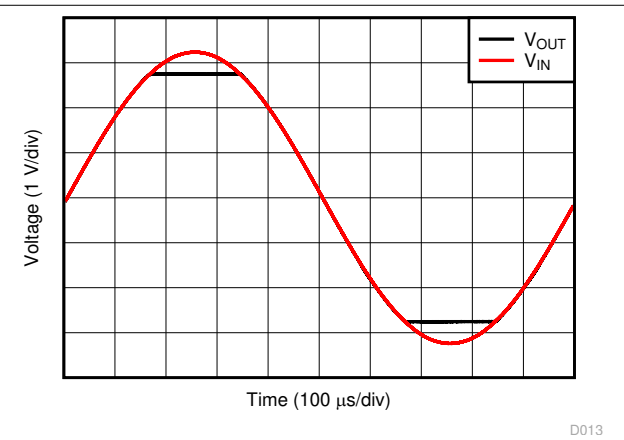

Figure 5-18. No Phase Reversal

5.8 Typical Characteristics (continued)

at $T_A = 25^\circ\text{C}$, $V_S = 5.5\text{V}$, $R_L = 10\text{k}\Omega$ connected to $V_S / 2$, $V_{CM} = V_S / 2$, and $V_{OUT} = V_S / 2$ (unless otherwise noted)

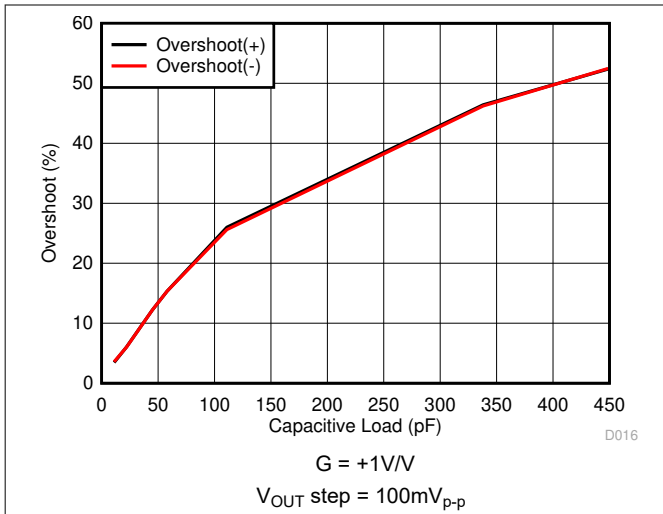

Figure 5-19. Small-Signal Overshoot vs Load Capacitance

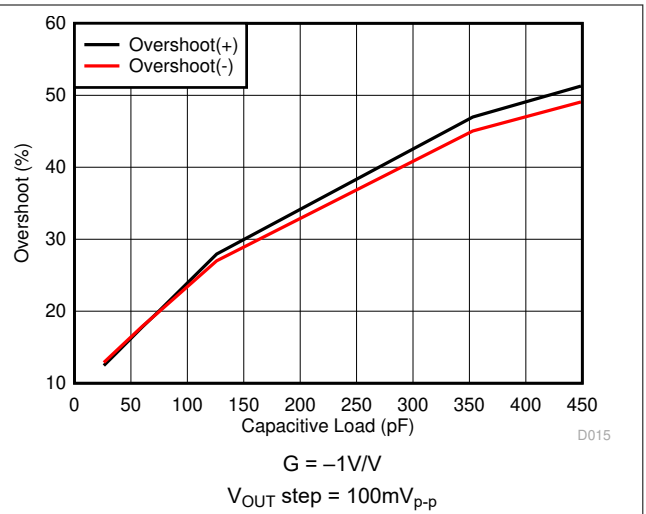

Figure 5-20. Small-Signal Overshoot vs Load Capacitance

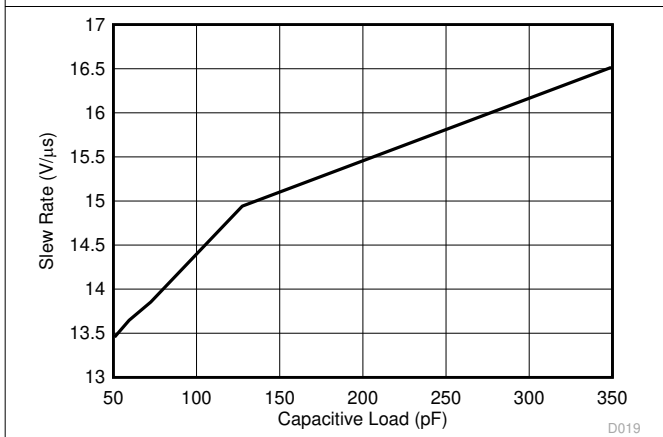

Figure 5-21. Slew Rate vs Capacitive Load

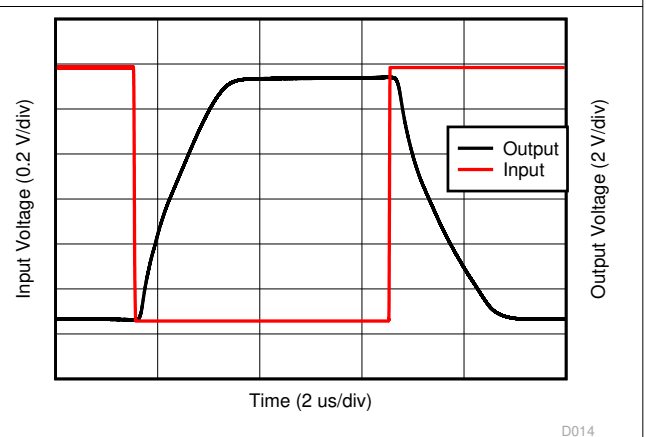

Figure 5-22. Overload Recovery

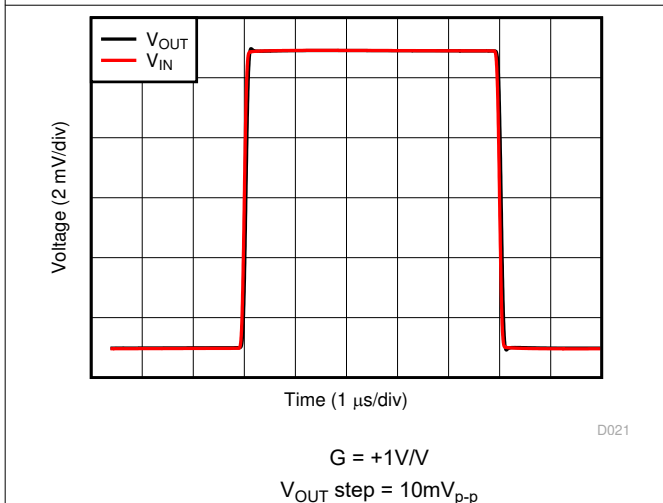

Figure 5-23. Small-Signal Step Response

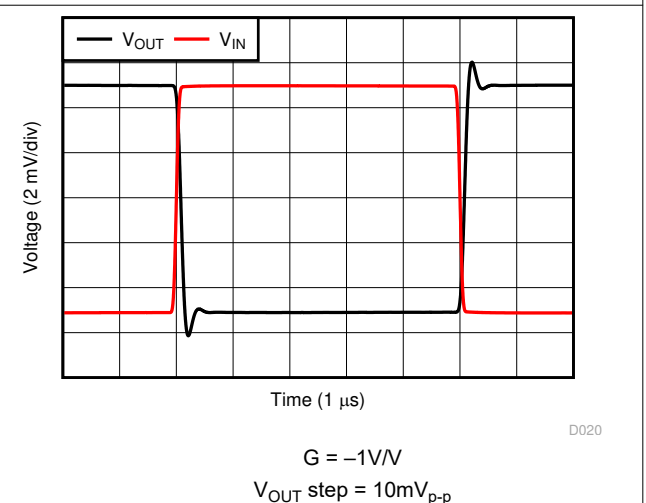

Figure 5-24. Small-Signal Step Response

5.8 Typical Characteristics (continued)

at $T_A = 25^\circ\text{C}$, $V_S = 5.5\text{V}$, $R_L = 10\text{k}\Omega$ connected to $V_S / 2$, $V_{CM} = V_S / 2$, and $V_{OUT} = V_S / 2$ (unless otherwise noted)

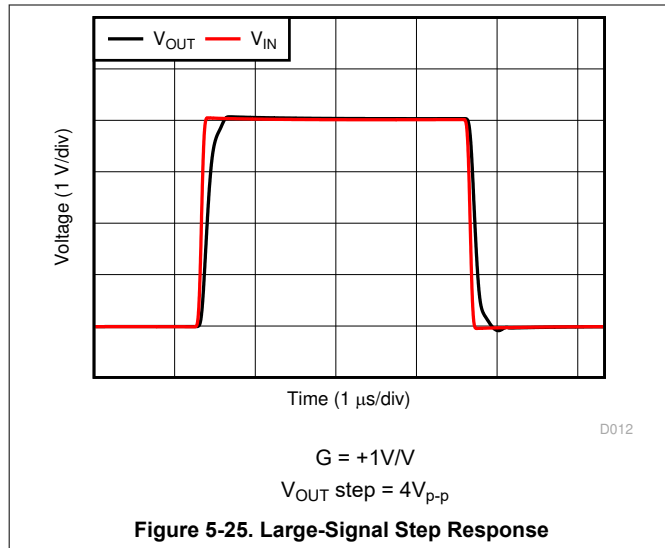

Figure 5-25. Large-Signal Step Response

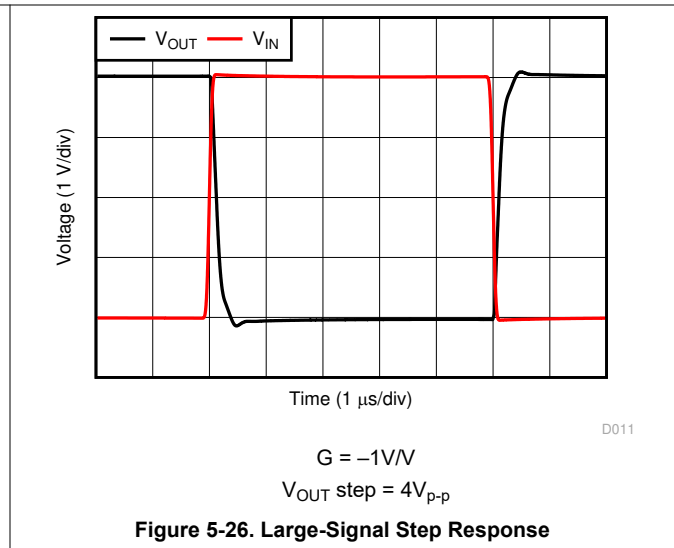

Figure 5-26. Large-Signal Step Response

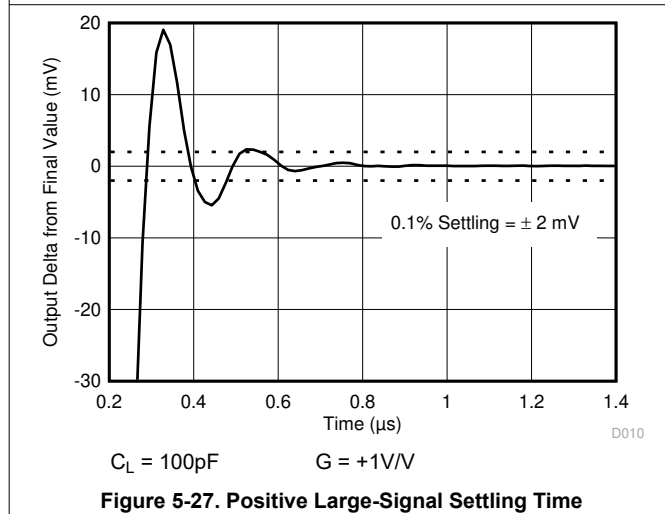

Figure 5-27. Positive Large-Signal Settling Time

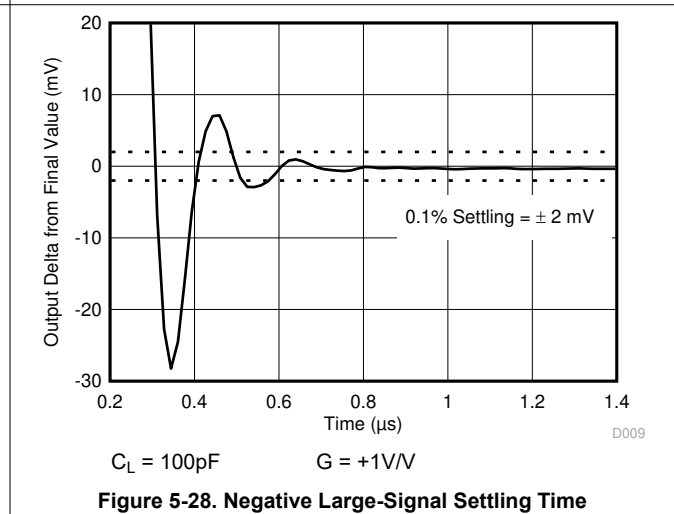

Figure 5-28. Negative Large-Signal Settling Time

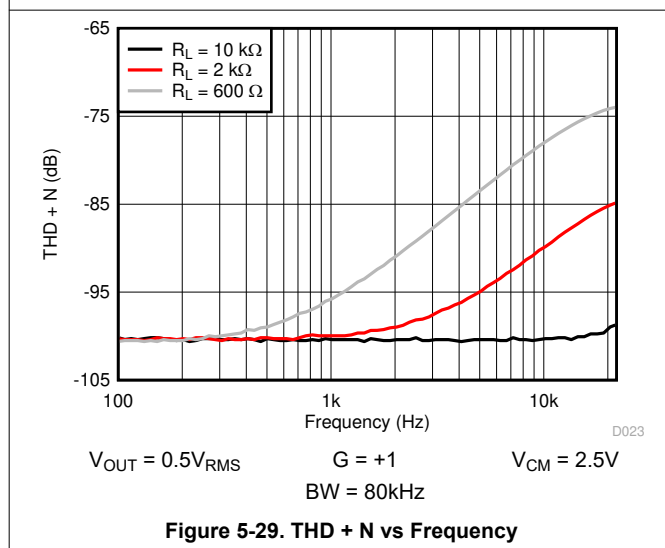

Figure 5-29. THD + N vs Frequency

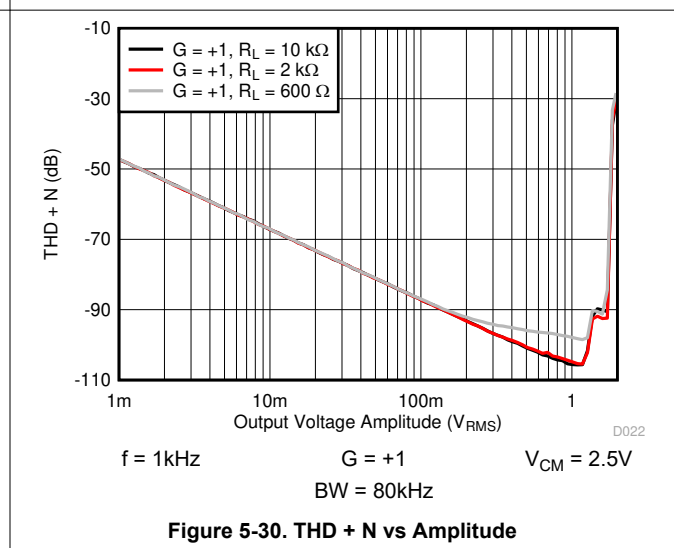

Figure 5-30. THD + N vs Amplitude

5.8 Typical Characteristics (continued)

at $T_A = 25^\circ\text{C}$, $V_S = 5.5\text{V}$, $R_L = 10\text{k}\Omega$ connected to $V_S / 2$, $V_{CM} = V_S / 2$, and $V_{OUT} = V_S / 2$ (unless otherwise noted)

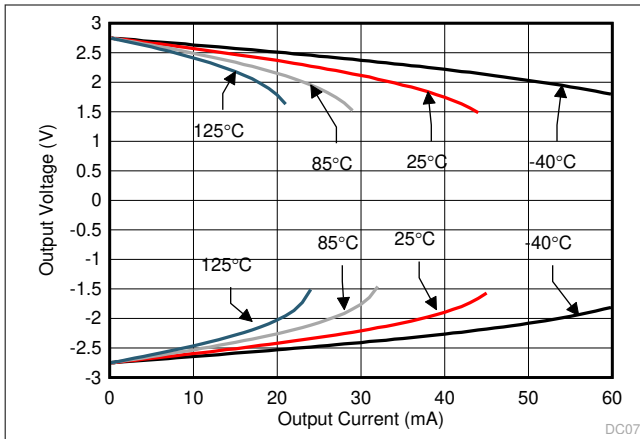

Figure 5-31. Output Voltage Swing vs Output Current

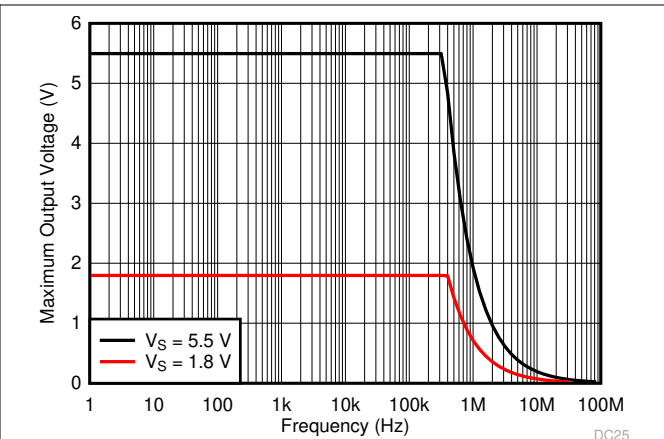

Figure 5-32. Maximum Output Voltage vs Frequency and Supply Voltage

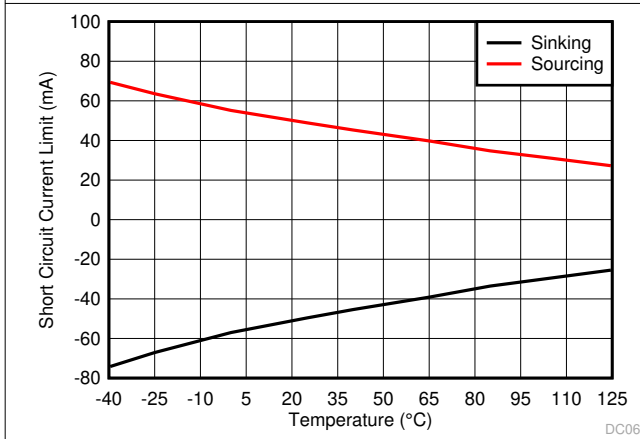

Figure 5-33. Short-Circuit Current vs Temperature

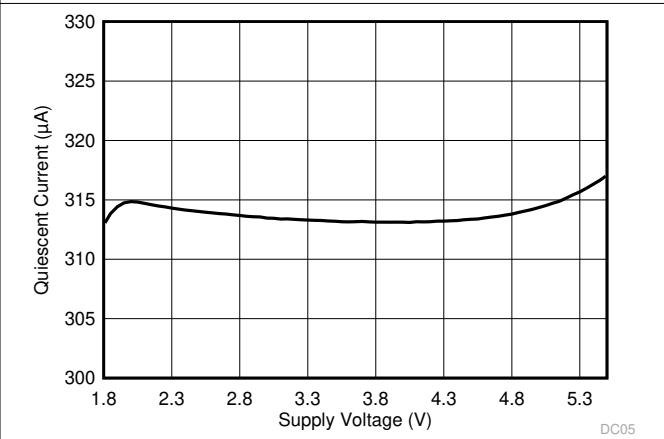

Figure 5-34. Quiescent Current vs Supply Voltage

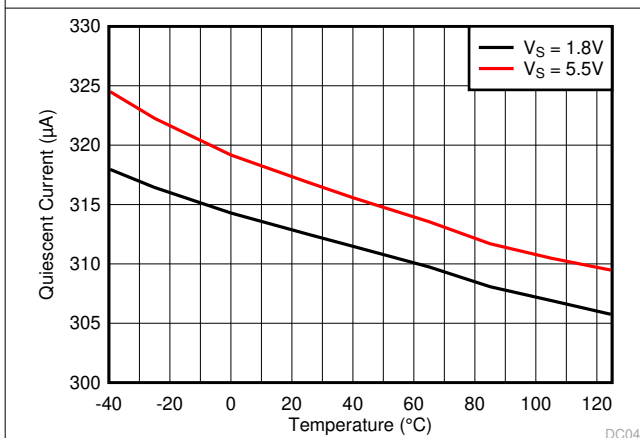

Figure 5-35. Quiescent Current vs Temperature

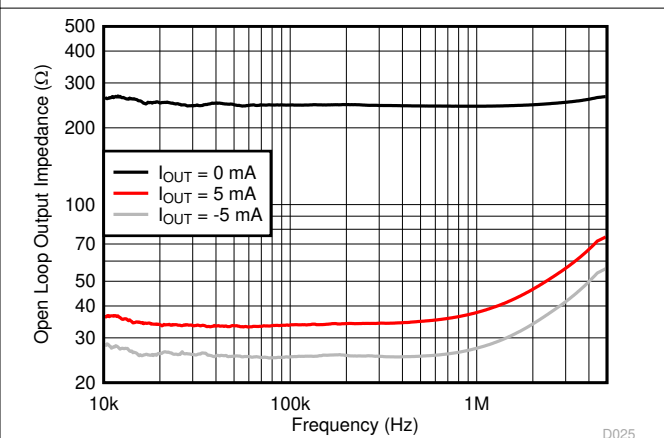
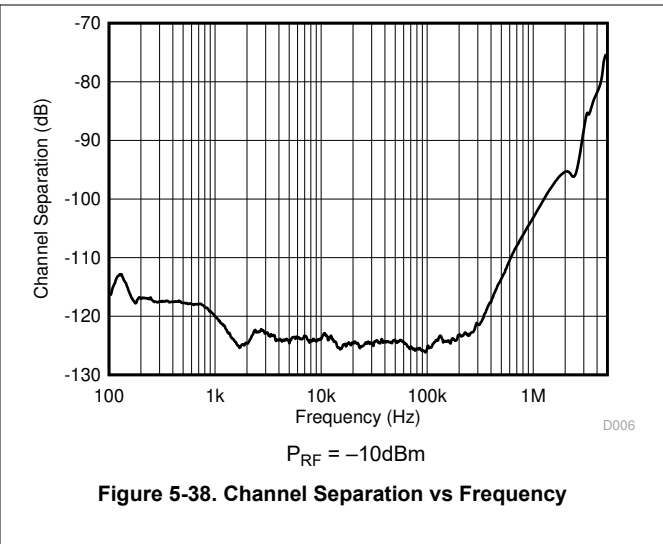
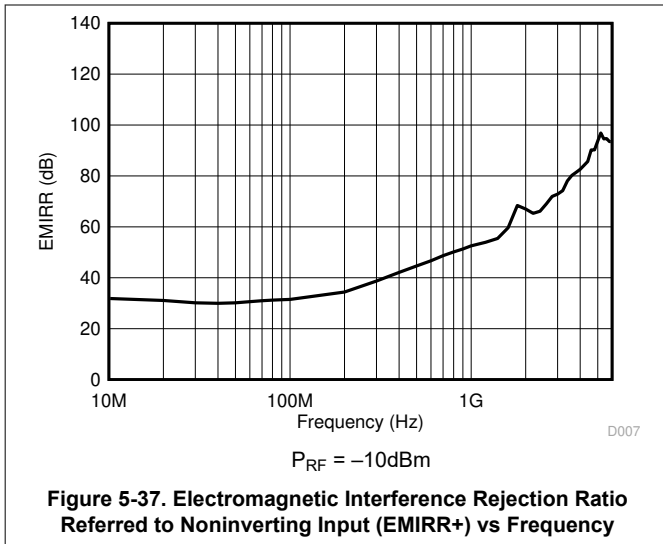

Figure 5-36. Open-Loop Output Impedance vs Frequency

5.8 Typical Characteristics (continued)

at $T_A = 25^\circ\text{C}$, $V_S = 5.5\text{V}$, $R_L = 10\text{k}\Omega$ connected to $V_S / 2$, $V_{CM} = V_S / 2$, and $V_{OUT} = V_S / 2$ (unless otherwise noted)



6 Detailed Description

6.1 Overview

The TLV905x-Q1 devices are a 5MHz family of low-power, rail-to-rail input and output op amps. These devices operate from 1.8V to 6V, are unity-gain stable, and are designed for a wide range of general-purpose applications. The input common-mode voltage range includes both rails and allows the TLV905x-Q1 family to be used in virtually any single-supply application. The unique combination of a high slew rate and low quiescent current makes this family a potential choice for battery-powered motor-drive applications. Rail-to-rail input and output swing significantly increases dynamic range, especially in low-supply applications.

6.2 Functional Block Diagram

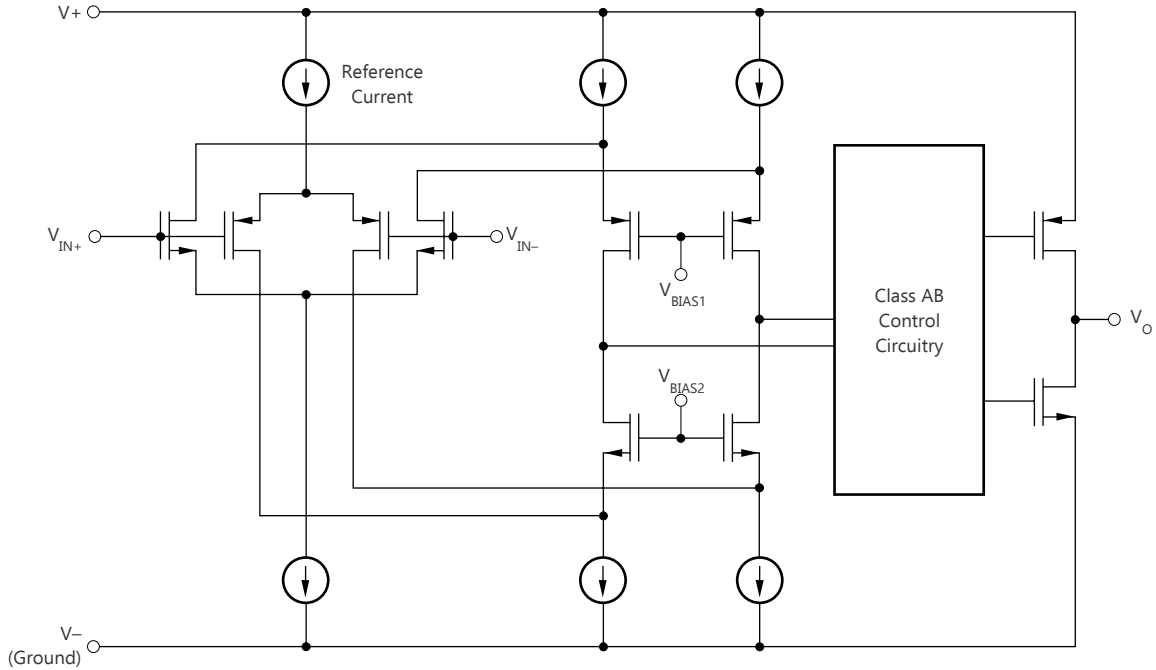

6.3 Feature Description

6.3.1 Operating Voltage

The TLV905x-Q1 family of op amps is specified for operation from 1.8V to 6.0V. In addition, many specifications apply from -40°C to 125°C . Parameters that vary significantly with operating voltages or temperature are illustrated in the [Typical Characteristics](#).

6.3.2 Rail-to-Rail Input

The input common-mode voltage range of the TLV905x-Q1 family extends 100mV beyond the supply rails for the full supply voltage range of 1.8V to 6.0V. This performance is achieved with a complementary input stage: an N-channel input differential pair in parallel with a P-channel differential pair, as shown in the [Functional Block Diagram](#). The N-channel pair is active for input voltages close to the positive rail, typically $(V+) - 1.4\text{V}$ to 200mV above the positive supply, whereas the P-channel pair is active for inputs from 200mV below the negative supply to approximately $(V+) - 1.4\text{V}$. There is a small transition region, typically $(V+) - 1.2\text{V}$ to $(V+) - 1\text{V}$, in which both pairs are on. This 200mV transition region can vary up to 200mV with process variation. Thus, the transition region (with both stages on) can range from $(V+) - 1.4\text{V}$ to $(V+) - 1.2\text{V}$ on the low end, and up to $(V+) - 1\text{V}$ to $(V+) - 0.8\text{V}$ on the high end. Within this transition region, PSRR, CMRR, offset voltage, offset drift, and THD can degrade compared to device operation outside this region.

6.3.3 Rail-to-Rail Output

Designed as low-power, low-voltage operational amplifiers, the TLV905x-Q1 family delivers a robust output drive capability. A class AB output stage with common-source transistors achieves full rail-to-rail output swing capability. For resistive loads of 10k Ω , the output swings to within 16mV of either supply rail, regardless of the applied power-supply voltage. Different load conditions change the ability of the amplifier to swing close to the rails.

6.3.4 EMI Rejection

The TLV905x-Q1 uses integrated electromagnetic interference (EMI) filtering to reduce the effects of EMI from sources such as wireless communications and densely-populated boards with a mix of analog signal chain and digital components. EMI immunity can be improved with circuit design techniques; the TLV905x-Q1 benefits from these design improvements. Texas Instruments has developed the ability to accurately measure and quantify the immunity of an operational amplifier over a broad frequency spectrum extending from 10MHz to 6GHz. [Figure 6-1](#) shows the results of this testing on the TLV905x-Q1. [Table 6-1](#) lists the EMIRR IN+ values for the TLV905x-Q1 at particular frequencies commonly encountered in real-world applications. The [EMI Rejection Ratio of Operational Amplifiers](#) application note contains detailed information on the topic of EMIRR performance as it relates to operational amplifiers.

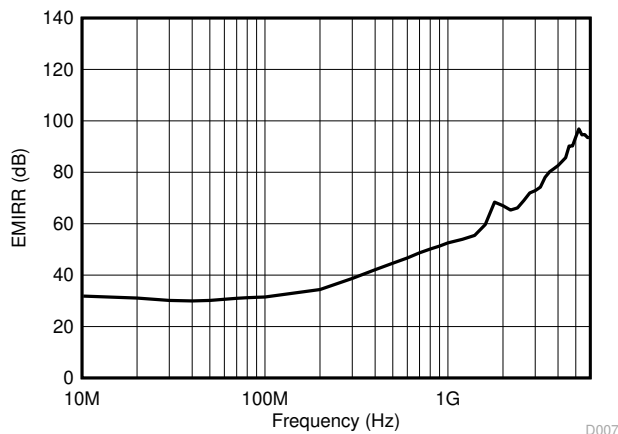

Figure 6-1. EMIRR Testing

Table 6-1. TLV905x-Q1 EMIRR IN+ for Frequencies of Interest

| FREQUENCY | APPLICATION OR ALLOCATION | EMIRR IN+ |
|-----------|--------------------------------------------------------------------------------------------------------------------------------------------------------------------------------|-----------|
| 400MHz | Mobile radio, mobile satellite, space operation, weather, radar, ultra-high frequency (UHF) applications | 41.8dB |
| 900MHz | Global system for mobile communications (GSM) applications, radio communication, navigation, GPS (to 1.6GHz), GSM, aeronautical mobile, UHF applications | 53.1dB |
| 1.8GHz | GSM applications, mobile personal communications, broadband, satellite, L-band (1GHz to 2GHz) | 71.8dB |
| 2.4GHz | 802.11b, 802.11g, 802.11n, Bluetooth®, mobile personal communications, industrial, scientific and medical (ISM) radio band, amateur radio and satellite, S-band (2GHz to 4GHz) | 70.0dB |
| 3.6GHz | Radiolocation, aero communication and navigation, satellite, mobile, S-band | 81.2dB |
| 5GHz | 802.11a, 802.11n, aero communication and navigation, mobile communication, space and satellite operation, C-band (4GHz to 8GHz) | 92.5dB |

6.3.5 Overload Recovery

Overload recovery is defined as the time required for the operational amplifier output to recover from a saturated state to a linear state. The output devices of the operational amplifier enter a saturation region when the output voltage exceeds the rated operating voltage, because of the high input voltage or high gain. After the device enters the saturation region, the output devices require time to return to the linear operating state. After the output devices return to a linear operating state, the device begins to slew at the specified slew rate. Therefore, the propagation delay (in case of an overload condition) is the sum of the overload recovery time and the slew time. The overload recovery time for the TLV905x-Q1 family is approximately 300ns.

6.3.6 Electrical Overstress

Designers often ask questions about the capability of an operational amplifier to withstand electrical overstress. These questions tend to focus on the device inputs, but can involve the supply voltage pins or even the output pin. Each of these different pin functions have electrical stress limits determined by the voltage breakdown characteristics of the particular semiconductor fabrication process and specific circuits connected to the pin. Additionally, internal electrostatic discharge (ESD) protection is built into these circuits to protect them from accidental ESD events both before and during product assembly.

Having a good understanding of this basic ESD circuitry and the relevance ESD circuitry has to an electrical overstress event is helpful. Figure 6-2 shows the ESD circuits contained in the TLV905x-Q1 devices. The ESD protection circuitry involves several current-steering diodes connected from the input and output pins and routed back to the internal power supply lines, where the diode routes meet at an absorption device internal to the operational amplifier. This protection circuitry is intended to remain inactive during normal circuit operation.

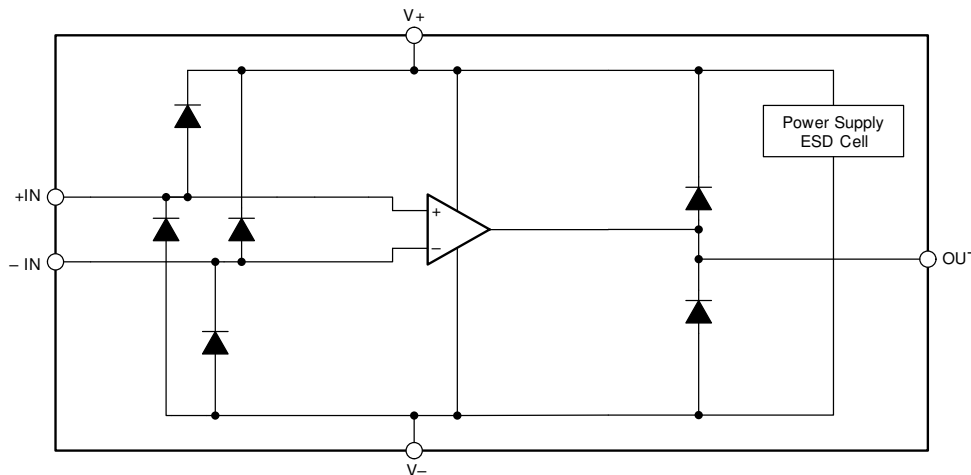

Figure 6-2. Equivalent Internal ESD Circuitry

6.3.7 Input Protection

The TLV905x-Q1 family incorporates internal ESD protection circuits on all pins. For input and output pins, this protection primarily consists of current-steering diodes connected between the input and power-supply pins. These ESD protection diodes provide in-circuit, input overdrive protection, as long as the current is limited to 10mA (for more information, see [Absolute Maximum Ratings](#)). [Figure 6-3](#) shows how a series input resistor can be added to the driven input to limit the input current. The added resistor contributes thermal noise at the amplifier input and the value must be kept to a minimum in noise-sensitive applications.

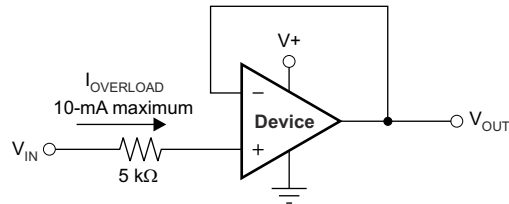

Figure 6-3. Input Current Protection

6.4 Device Functional Modes

The TLV905x-Q1 family is operational when the power-supply voltage is between 1.8V ($\pm 0.9V$) and 6.0V ($\pm 3.0V$).

7 Application and Implementation

Note

Information in the following applications sections is not part of the TI component specification, and TI does not warrant its accuracy or completeness. TI's customers are responsible for determining suitability of components for their purposes, as well as validating and testing their design implementation to confirm system functionality.

7.1 Application Information

The TLV905x-Q1 family features 5MHz bandwidth and very high slew rate of 15V/ μ s with only 330 μ A of supply current per channel, providing excellent AC performance at very low-power consumption. DC applications are well served with a very low input noise voltage of 15nV/ $\sqrt{\text{Hz}}$ at 10kHz, low input bias current, and a typical input offset voltage of 0.33mV.

7.2 Typical Low-Side Current Sense Application

Figure 7-1 shows the TLV905x-Q1 configured in a low-side current sensing application.

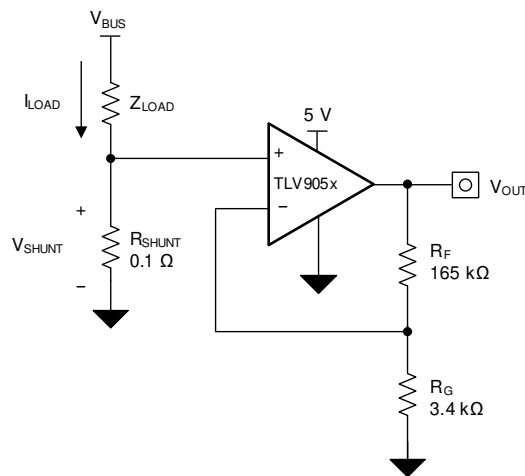

Figure 7-1. TLV905x-Q1 in a Low-Side, Current-Sensing Application

7.2.1 Design Requirements

The design requirements for this design are:

- Load current: 0A to 1A
- Output voltage: 4.95V
- Maximum shunt voltage: 100mV

7.2.2 Detailed Design Procedure

The transfer function of the circuit in [Figure 7-1](#) is given in [Equation 1](#).

$$V_{OUT} = I_{LOAD} \times R_{SHUNT} \times \text{Gain} \quad (1)$$

The load current (I_{LOAD}) produces a voltage drop across the shunt resistor (R_{SHUNT}). The load current is set from 0A to 1A. To keep the shunt voltage below 100mV at maximum load current, the largest shunt resistor is defined using [Equation 2](#).

$$R_{SHUNT} = \frac{V_{SHUNT_MAX}}{I_{LOAD_MAX}} = \frac{100 \text{ mV}}{1 \text{ A}} = 100 \text{ m}\Omega \quad (2)$$

Using [Equation 2](#), R_{SHUNT} equals 100m Ω . The voltage drop produced by I_{LOAD} and R_{SHUNT} is amplified by the TLV905x-Q1 device to produce an output voltage of approximately 0V to 4.95V. [Equation 3](#) calculates the gain required for the TLV905x-Q1 device to produce the required output voltage.

$$\text{Gain} = \frac{(V_{OUT_MAX} - V_{OUT_MIN})}{(V_{IN_MAX} - V_{IN_MIN})} \quad (3)$$

Using [Equation 3](#), the required gain equals 49.5V/V, which is set with the R_F and R_G resistors. [Equation 4](#) sizes the R_F and R_G resistors to set the gain of the TLV905x-Q1 device to 49.5V/V.

$$\text{Gain} = 1 + \frac{(R_F)}{(R_G)} \quad (4)$$

Selecting R_F to equal 165k Ω and R_G to equal 3.4k Ω provides a combination that equals approximately 49.5V/V. [Figure 7-2](#) shows the measured transfer function of the circuit shown in [Figure 7-1](#).

7.2.3 Application Curve

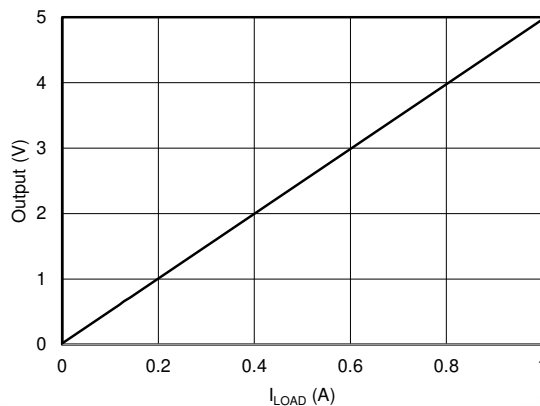

Figure 7-2. Low-Side, Current-Sense Transfer Function

7.3 Power Supply Recommendations

The TLV905x-Q1 family is specified for operation from 1.8V to 6.0V ($\pm 0.9V$ to $\pm 3.0V$); many specifications apply from -40°C to 125°C . The [Typical Characteristics](#) section presents parameters that can exhibit significant variance with regard to operating voltage or temperature.

CAUTION

Supply voltages larger than 7V can permanently damage the device; for more information, see the [Absolute Maximum Ratings](#) table.

Place 0.1 μF bypass capacitors close to the power-supply pins to reduce errors coupling in from noisy or high-impedance power supplies. For more-detailed information on bypass capacitor placement, see [Figure 7-3](#).

7.4 Layout

7.4.1 Layout Guidelines

For best operational performance of the device, use good printed circuit board (PCB) layout practices, including:

- Noise can propagate into analog circuitry through the power pins of the circuit as a whole, as well as through the op amp. Bypass capacitors are used to reduce the coupled noise by providing low-impedance power sources local to the analog circuitry.
 - Connect low-ESR, 0.1 μF ceramic bypass capacitors between each supply pin and ground, placed as close to the device as possible. A single bypass capacitor from V+ to ground is applicable for single-supply applications.
- Separate grounding for analog and digital portions of circuitry is one of the simplest and most-effective methods of noise suppression. One or more layers on multilayer PCBs are usually devoted to ground planes. A ground plane helps distribute heat and reduces electromagnetic interference (EMI) noise pickup. Take care to physically separate digital and analog grounds, paying attention to the flow of the ground current. For more detailed information, see [Circuit Board Layout Techniques](#).
- To reduce parasitic coupling, run the input traces as far away from the supply or output traces as possible. If these traces cannot be kept separate, crossing the sensitive trace perpendicular is much better as opposed to in parallel with the noisy trace.
- Place the external components as close to the device as possible. As illustrated in [Figure 7-3](#), keeping R_F and R_G close to the inverting input minimizes parasitic capacitance on the inverting input.
- Keep the length of input traces as short as possible. Always remember that the input traces are the most sensitive part of the circuit.
- Consider a driven, low-impedance guard ring around the critical traces. A guard ring can significantly reduce leakage currents from nearby traces that are at different potentials.
- Cleaning the PCB following board assembly is recommended for best performance.
- Any precision integrated circuit can experience performance shifts resulting from moisture ingress into the plastic package. Following any aqueous PCB cleaning process, baking the PCB assembly is recommended to remove moisture introduced into the device packaging during the cleaning process. A low-temperature, post-cleaning bake at 85°C for 30 minutes is sufficient for most circumstances.

7.4.2 Layout Example

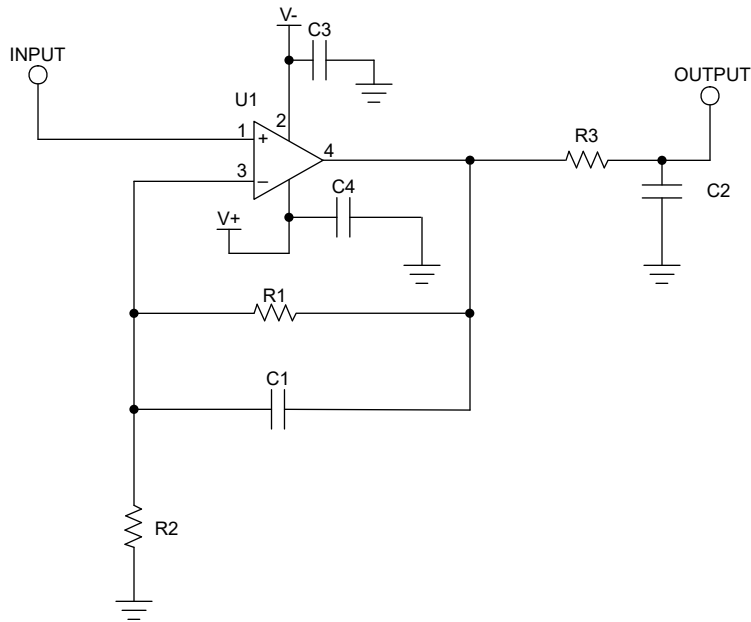

Figure 7-3. Schematic for Noninverting Configuration Layout Example

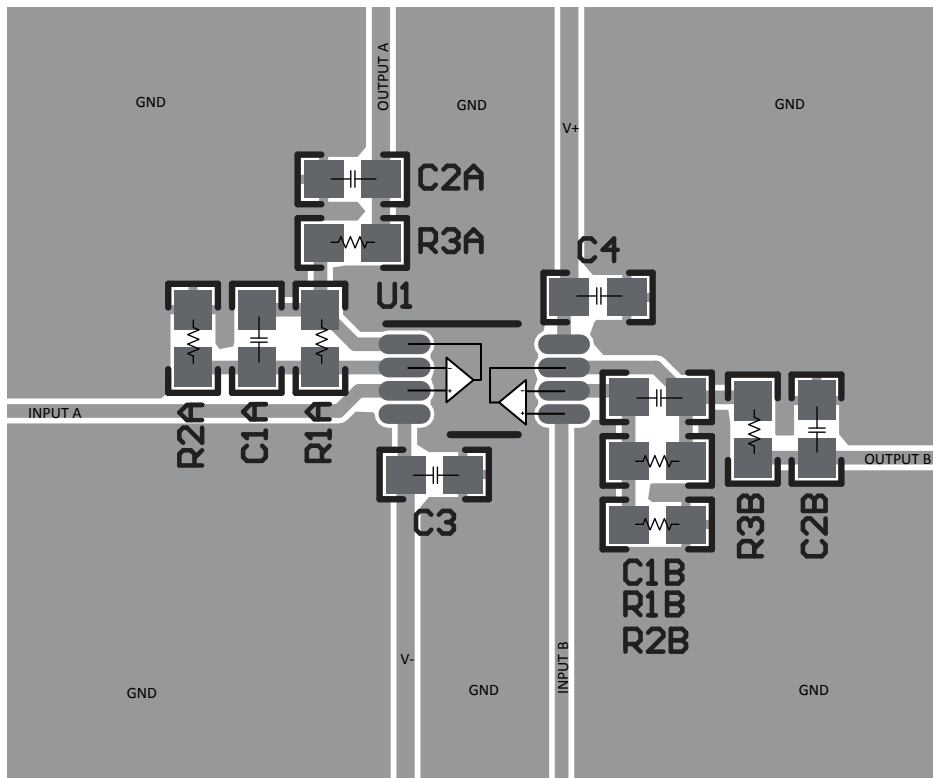

Figure 7-4. Example Layout for VSSOP-8 (DGK) Package

8 Device and Documentation Support

8.1 Device Support

8.1.1 Development Support

8.1.1.1 TINA-TI™ (Free Software Download)

TINA™ is a simple, powerful, and easy-to-use circuit simulation program based on a SPICE engine. TINA-TI is a free, fully-functional version of the TINA software, preloaded with a library of macro models in addition to a range of both passive and active models. TINA-TI provides all the conventional dc, transient, and frequency domain analysis of SPICE, as well as additional design capabilities.

Available as a [free download](#) from the Analog eLab Design Center, TINA-TI offers extensive post-processing capability that allows users to format results in a variety of ways. Virtual instruments offer the ability to select input waveforms and probe circuit nodes, voltages, and waveforms, creating a dynamic quick-start tool.

Note

These files require that either the TINA software (from DesignSoft™) or TINA-TI software be installed. Download the free TINA-TI software from the [TINA-TI folder](#).

8.2 Documentation Support

8.2.1 Related Documentation

For related documentation, see the following:

- Texas Instruments, [EMI Rejection Ratio of Operational Amplifiers application note](#)
- Texas Instruments, [Low Voltage, High Slew Rate Op-amps for Motor Drive Circuits application note](#)
- Texas Instruments, [TI Analog Circuit Cookbook Analog Engineer's Circuit](#)
- Texas Instruments, [TI Precision Labs - Amplifiers training video](#)

8.3 Receiving Notification of Documentation Updates

To receive notification of documentation updates, navigate to the device product folder on [ti.com](#). Click on *Notifications* to register and receive a weekly digest of any product information that has changed. For change details, review the revision history included in any revised document.

8.4 Support Resources

[TI E2E™ support forums](#) are an engineer's go-to source for fast, verified answers and design help — straight from the experts. Search existing answers or ask your own question to get the quick design help you need.

Linked content is provided "AS IS" by the respective contributors. They do not constitute TI specifications and do not necessarily reflect TI's views; see TI's [Terms of Use](#).

8.5 Trademarks

TINA-TI™ is a trademark of Texas Instruments, Inc and DesignSoft, Inc.

TINA™ and DesignSoft™ are trademarks of DesignSoft, Inc.

TI E2E™ is a trademark of Texas Instruments.

Bluetooth® is a registered trademark of Bluetooth SIG, Inc.

All trademarks are the property of their respective owners.

8.6 Electrostatic Discharge Caution



This integrated circuit can be damaged by ESD. Texas Instruments recommends that all integrated circuits be handled with appropriate precautions. Failure to observe proper handling and installation procedures can cause damage.

ESD damage can range from subtle performance degradation to complete device failure. Precision integrated circuits may be more susceptible to damage because very small parametric changes could cause the device not to meet its published specifications.

8.7 Glossary

[TI Glossary](#)

This glossary lists and explains terms, acronyms, and definitions.

9 Revision History

NOTE: Page numbers for previous revisions may differ from page numbers in the current version.

| Changes from Revision A (May 2024) to Revision B (May 2024) | Page |
|---------------------------------------------------------------------------------------|------|
| • Added footnote about extended high differential input voltage usage..... | 6 |
| • Changed the maximum input offset voltage across temperature from 2mV to 2.24mV..... | 8 |

| Changes from Revision * (February 2024) to Revision A (May 2024) | Page |
|-----------------------------------------------------------------------------------------------------------|------|
| • Added AEC-Q100 qualifications to the <i>Features</i> section..... | 1 |
| • Changed the status of the SOT-23 (5) and TSSOP (8) packages from: <i>preview</i> to <i>active</i> | 1 |

10 Mechanical, Packaging, and Orderable Information

The following pages include mechanical, packaging, and orderable information. This information is the most-current data available for the designated devices. This data is subject to change without notice and without revision of this document. For browser-based versions of this data sheet, see the left-hand navigation pane.

PACKAGING INFORMATION

| Orderable Device | Status (1) | Package Type | Package Drawing | Pins | Package Qty | Eco Plan (2) | Lead finish/ Ball material (6) | MSL Peak Temp (3) | Op Temp (°C) | Device Marking (4/5) | Samples |
|------------------|---------------|--------------|-----------------|------|-------------|-----------------|--------------------------------------|----------------------|--------------|-------------------------|-------------------------|
| TLV9051QDBVRQ1 | ACTIVE | SOT-23 | DBV | 5 | 3000 | RoHS & Green | Call TI | Level-1-260C-UNLIM | -40 to 125 | TL51Q | Samples |
| TLV9052QPWRQ1 | ACTIVE | TSSOP | PW | 8 | 3000 | RoHS & Green | NIPDAU | Level-1-260C-UNLIM | -40 to 125 | QTL905 | Samples |

(1) The marketing status values are defined as follows:

ACTIVE: Product device recommended for new designs.

LIFEBUY: TI has announced that the device will be discontinued, and a lifetime-buy period is in effect.

NRND: Not recommended for new designs. Device is in production to support existing customers, but TI does not recommend using this part in a new design.

PREVIEW: Device has been announced but is not in production. Samples may or may not be available.

OBSOLETE: TI has discontinued the production of the device.

(2) **RoHS:** TI defines "RoHS" to mean semiconductor products that are compliant with the current EU RoHS requirements for all 10 RoHS substances, including the requirement that RoHS substance do not exceed 0.1% by weight in homogeneous materials. Where designed to be soldered at high temperatures, "RoHS" products are suitable for use in specified lead-free processes. TI may reference these types of products as "Pb-Free".

RoHS Exempt: TI defines "RoHS Exempt" to mean products that contain lead but are compliant with EU RoHS pursuant to a specific EU RoHS exemption.

Green: TI defines "Green" to mean the content of Chlorine (Cl) and Bromine (Br) based flame retardants meet JS709B low halogen requirements of <=1000ppm threshold. Antimony trioxide based flame retardants must also meet the <=1000ppm threshold requirement.

(3) MSL, Peak Temp. - The Moisture Sensitivity Level rating according to the JEDEC industry standard classifications, and peak solder temperature.

(4) There may be additional marking, which relates to the logo, the lot trace code information, or the environmental category on the device.

(5) Multiple Device Markings will be inside parentheses. Only one Device Marking contained in parentheses and separated by a "~" will appear on a device. If a line is indented then it is a continuation of the previous line and the two combined represent the entire Device Marking for that device.

(6) Lead finish/Ball material - Orderable Devices may have multiple material finish options. Finish options are separated by a vertical ruled line. Lead finish/Ball material values may wrap to two lines if the finish value exceeds the maximum column width.

Important Information and Disclaimer:The information provided on this page represents TI's knowledge and belief as of the date that it is provided. TI bases its knowledge and belief on information provided by third parties, and makes no representation or warranty as to the accuracy of such information. Efforts are underway to better integrate information from third parties. TI has taken and continues to take reasonable steps to provide representative and accurate information but may not have conducted destructive testing or chemical analysis on incoming materials and chemicals. TI and TI suppliers consider certain information to be proprietary, and thus CAS numbers and other limited information may not be available for release.

In no event shall TI's liability arising out of such information exceed the total purchase price of the TI part(s) at issue in this document sold by TI to Customer on an annual basis.

OTHER QUALIFIED VERSIONS OF TLV9051-Q1, TLV9052-Q1 :

- Catalog : [TLV9051](#), [TLV9052](#)

NOTE: Qualified Version Definitions:

- Catalog - TI's standard catalog product

TAPE AND REEL INFORMATION

QUADRANT ASSIGNMENTS FOR PIN 1 ORIENTATION IN TAPE

*All dimensions are nominal

| Device | Package Type | Package Drawing | Pins | SPQ | Reel Diameter (mm) | Reel Width W1 (mm) | A0 (mm) | B0 (mm) | K0 (mm) | P1 (mm) | W (mm) | Pin1 Quadrant |
|----------------|--------------|-----------------|------|------|--------------------|--------------------|---------|---------|---------|---------|--------|---------------|
| TLV9051QDBVRQ1 | SOT-23 | DBV | 5 | 3000 | 180.0 | 8.4 | 3.2 | 3.2 | 1.4 | 4.0 | 8.0 | Q3 |
| TLV9052QPWRQ1 | TSSOP | PW | 8 | 3000 | 330.0 | 12.4 | 7.0 | 3.6 | 1.6 | 8.0 | 12.0 | Q1 |

TAPE AND REEL BOX DIMENSIONS

*All dimensions are nominal

| Device | Package Type | Package Drawing | Pins | SPQ | Length (mm) | Width (mm) | Height (mm) |
|----------------|--------------|-----------------|------|------|-------------|------------|-------------|
| TLV9051QDBVRQ1 | SOT-23 | DBV | 5 | 3000 | 210.0 | 185.0 | 35.0 |
| TLV9052QPWRQ1 | TSSOP | PW | 8 | 3000 | 353.0 | 353.0 | 32.0 |

IMPORTANT NOTICE AND DISCLAIMER

TI PROVIDES TECHNICAL AND RELIABILITY DATA (INCLUDING DATA SHEETS), DESIGN RESOURCES (INCLUDING REFERENCE DESIGNS), APPLICATION OR OTHER DESIGN ADVICE, WEB TOOLS, SAFETY INFORMATION, AND OTHER RESOURCES "AS IS" AND WITH ALL FAULTS, AND DISCLAIMS ALL WARRANTIES, EXPRESS AND IMPLIED, INCLUDING WITHOUT LIMITATION ANY IMPLIED WARRANTIES OF MERCHANTABILITY, FITNESS FOR A PARTICULAR PURPOSE OR NON-INFRINGEMENT OF THIRD PARTY INTELLECTUAL PROPERTY RIGHTS.

These resources are intended for skilled developers designing with TI products. You are solely responsible for (1) selecting the appropriate TI products for your application, (2) designing, validating and testing your application, and (3) ensuring your application meets applicable standards, and any other safety, security, regulatory or other requirements.

These resources are subject to change without notice. TI grants you permission to use these resources only for development of an application that uses the TI products described in the resource. Other reproduction and display of these resources is prohibited. No license is granted to any other TI intellectual property right or to any third party intellectual property right. TI disclaims responsibility for, and you will fully indemnify TI and its representatives against, any claims, damages, costs, losses, and liabilities arising out of your use of these resources.

TI's products are provided subject to [TI's Terms of Sale](#) or other applicable terms available either on [ti.com](https://www.ti.com) or provided in conjunction with such TI products. TI's provision of these resources does not expand or otherwise alter TI's applicable warranties or warranty disclaimers for TI products.

TI objects to and rejects any additional or different terms you may have proposed.

Mailing Address: Texas Instruments, Post Office Box 655303, Dallas, Texas 75265
Copyright © 2024, Texas Instruments Incorporated