

# TLV3604, TLV3605, TLV3607 800ps High-Speed RRI Comparators with LVDS Outputs

## 1 Features

- Low propagation delay: 800ps
- Low overdrive dispersion: 350ps
- Quiescent current: 12.1mA
- High toggle frequency: 1.5GHz / 3.0Gbps
- Narrow pulse width detection capability: 600ps
- LVDS output
- Supply range: 2.4V to 5.5V
- Input common-mode range extends 200mV beyond both rails
- Low input offset voltage:  $\pm 5\text{mV}$
- Single and dual channel options

## 2 Applications

- [Distance sensing in LIDAR](#)
- [Time-of-Flight sensors](#)
- [High speed trigger function in oscilloscope and logic analyzer](#)
- [High speed differential line receiver](#)
- [Drone vision](#)

## 3 Description

The TLV3604, TLV3605 (single channel), and TLV3607 (dual channel) are 800ps, high-speed comparators with LVDS outputs and rail-to-rail inputs. These features, along with an operating voltage range of 2.4V to 5.5V and a high toggle frequency of 3Gbps, make them well suited for LIDAR, clock and data recovery applications, and test and measurement systems.

Likewise, the TLV3604, TLV3605 and TLV3607 have strong input overdrive performance of 350ps and are

able to detect narrow pulse widths of just 600ps. This combination of low variation in propagation delay due to input overdrive and the ability to detect narrow pulses improve system performance and extend distance range in Time-of-Flight (ToF) applications.

The Low-Voltage-Differential-Signal (LVDS) output of the TLV3604, TLV3605, and TLV3607 also helps increase data throughput and optimizes power consumption. The complementary outputs reduce EMI by suppressing common mode noise on each output. The LVDS output is designed to drive and interface directly with downstream devices that accept a standard LVDS input, such as high-speed FPGAs and CPUs.

The TLV3604 is in a tiny 6 pin SC-70 package, which makes it easier for space sensitive applications such as an optical sensor module. The TLV3605 (single) and TLV3607 (dual) maintain the same performance as the TLV3604, and offer adjustable hysteresis control, shutdown, and latching features in 12 pin QFN and 16 pin WQFN packages, making them excellent choices for test and measurement applications.

### Device Information

| PART NUMBER | PACKAGE (1) | BODY SIZE (NOM) (2) |
|-------------|-------------|---------------------|
| TLV3604     | SC70 (6)    | 1.25mm × 2.00mm     |
| TLV3605     | QFN (12)    | 3.00mm × 3.00mm     |
| TLV3607     | WQFN (16)   | 4.00mm × 4.00mm     |

- (1) For all available packages, see the orderable addendum at the end of the data sheet.
- (2) The package size (length × width) is a nominal value and includes pins, where applicable.

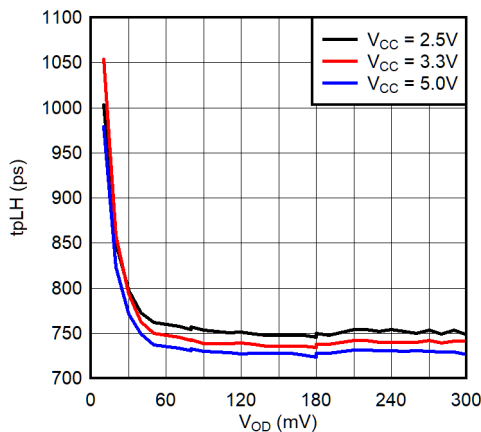

**TpLH v. Overdrive Dispersion**

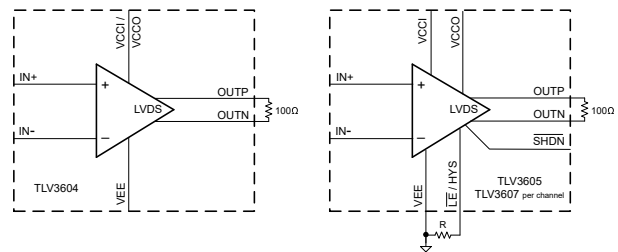

**Functional Block Diagram**



## Table of Contents

|                                                                            |    |                                                                      |    |
|----------------------------------------------------------------------------|----|----------------------------------------------------------------------|----|
| <b>1 Features</b> .....                                                    | 1  | 6.3 Feature Description.....                                         | 13 |
| <b>2 Applications</b> .....                                                | 1  | 6.4 Device Functional Modes.....                                     | 13 |
| <b>3 Description</b> .....                                                 | 1  | <b>7 Application and Implementation</b> .....                        | 14 |
| <b>4 Pin Configuration and Functions</b> .....                             | 3  | 7.1 Application Information.....                                     | 14 |
| Pin Configurations: TLV3604 and TLV3605.....                               | 3  | 7.2 Typical Application.....                                         | 16 |
| 4.1 Pin Configuration: TLV3607.....                                        | 4  | 7.3 Power Supply Recommendations.....                                | 19 |
| <b>5 Specifications</b> .....                                              | 5  | 7.4 Layout.....                                                      | 19 |
| 5.1 Absolute Maximum Ratings.....                                          | 5  | <b>8 Device and Documentation Support</b> .....                      | 21 |
| 5.2 ESD Ratings.....                                                       | 5  | 8.1 Device Support.....                                              | 21 |
| 5.3 Recommended Operating Conditions.....                                  | 5  | 8.2 Receiving Notification of Documentation Updates....              | 21 |
| 5.4 Thermal Information.....                                               | 6  | 8.3 Support Resources.....                                           | 21 |
| 5.5 Electrical Characteristics ( $V_{CCI} = V_{CCO} = 2.5V$ to<br>5V)..... | 7  | 8.4 Trademarks.....                                                  | 21 |
| 5.6 Typical Characteristics.....                                           | 9  | 8.5 Electrostatic Discharge Caution.....                             | 21 |
| <b>6 Detailed Description</b> .....                                        | 13 | 8.6 Glossary.....                                                    | 21 |
| 6.1 Overview.....                                                          | 13 | <b>9 Revision History</b> .....                                      | 21 |
| 6.2 Functional Block Diagram.....                                          | 13 | <b>10 Mechanical, Packaging, and Orderable<br/>Information</b> ..... | 22 |

## 4 Pin Configuration and Functions

### Pin Configurations: TLV3604 and TLV3605

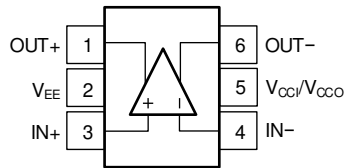

**Figure 4-1. DCK Package  
6-Pin SC70  
Top View**

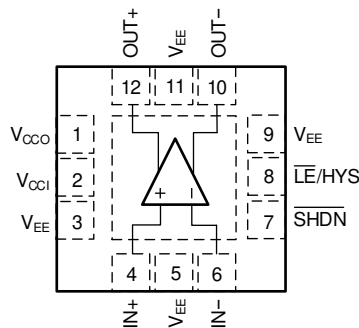
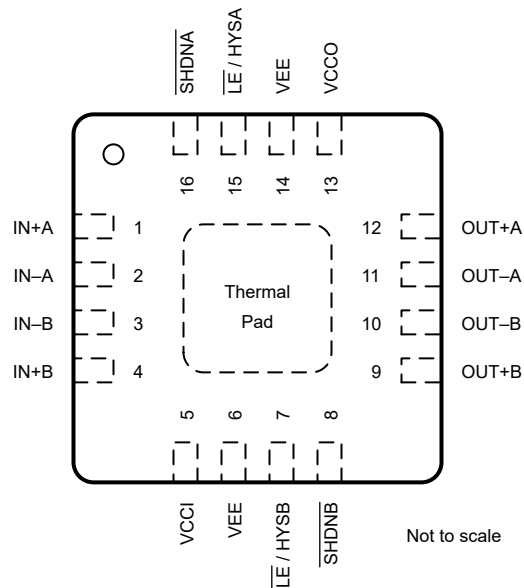

**Figure 4-2. RVK Package  
12-Pin QFN  
Top View**

**Table 4-1. Pin Functions: TLV3604 and TLV3605**

| NAME   | PIN     |             | I/O | DESCRIPTION                             |
|--------|---------|-------------|-----|-----------------------------------------|
|        | TLV3604 | TLV3605     |     |                                         |
| IN+    | 3       | 4           | I   | Non-inverting input                     |
| IN-    | 4       | 6           | I   | Inverting input                         |
| OUT+   | 1       | 12          | O   | Non-inverting output                    |
| OUT-   | 6       | 10          | O   | Inverting output                        |
| VEE    | 2       | 3, 5, 9, 11 | I   | Negative power supply                   |
| VCC1   | 5       | 2           | I   | Positive input section power supply     |
| VCCO   | 5       | 1           | I   | Positive output section power supply    |
| SHDN   | -       | 7           | I   | Shutdown control, active low            |
| LE/HYS | -       | 8           | I   | Adjustable hysteresis control and latch |

### 4.1 Pin Configuration: TLV3607



**Figure 4-3. RTE Package  
16-Pin WQFN with Exposed Thermal Pad  
Top View**

**Table 4-2. Pin Functions: TLV3607**

| PIN              |         | I/O | DESCRIPTION                                                           |
|------------------|---------|-----|-----------------------------------------------------------------------|
| NAME             | TLV3607 |     |                                                                       |
| IN+A             | 1       | I   | Channel A non-inverting input                                         |
| IN-A             | 2       | I   | Channel A inverting input                                             |
| IN-B             | 3       | I   | Channel B inverting input                                             |
| IN+B             | 4       | I   | Channel B non-inverting input                                         |
| OUT+A            | 12      | O   | Channel A non-inverting output                                        |
| OUT-A            | 11      | O   | Channel A inverting output                                            |
| OUT-B            | 10      | O   | Channel B inverting output                                            |
| OUT+B            | 9       | O   | Channel B non-inverting output                                        |
| V <sub>EE</sub>  | 6, 14   | I   | Negative power supply                                                 |
| V <sub>CCI</sub> | 5       | I   | Positive input section power supply                                   |
| V <sub>CCO</sub> | 13      | I   | Positive output section power supply                                  |
| SHDNA            | 16      | I   | Channel A shutdown control (active low)                               |
| SHDNB            | 8       | I   | Channel B shutdown control (active low)                               |
| LE/HYSA          | 15      | I   | Channel A latch enable (active low) and adjustable hysteresis control |
| LE/HYSB          | 7       | I   | Channel B latch enable (active low) and adjustable hysteresis control |

## 5 Specifications

### 5.1 Absolute Maximum Ratings

over operating free-air temperature range (unless otherwise noted)<sup>(1)</sup>

|                                                                                             | MIN                | MAX                | UNIT |
|---------------------------------------------------------------------------------------------|--------------------|--------------------|------|
| Input Supply Voltage: $V_{CCI} - V_{EE}$                                                    | -0.3               | 6                  | V    |
| Output Supply Voltage: $V_{CCO} - V_{EE}$                                                   | -0.3               | 6                  | V    |
| Supply Voltage Difference: $V_{CCI} - V_{CCO}$                                              | -6                 | 6                  | V    |
| Input Voltage (IN+, IN-) <sup>(2)</sup>                                                     | $V_{EE} - 0.3$     | $V_{CCI} + 0.3$    | V    |
| Differential Input Voltage ( $V_{DI} = IN+, IN-$ )                                          | $-(V_{CCI} + 0.3)$ | $+(V_{CCI} + 0.3)$ | V    |
| Output Voltage (OUT+, OUT-) <sup>(3)</sup>                                                  | $V_{EE} - 0.3$     | $V_{CCO} + 0.3$    | V    |
| Shutdown Enable ( $\overline{SHDN}$ )                                                       | $V_{EE} - 0.3$     | $V_{CCO} + 0.3$    | V    |
| Latch and Hysteresis Control ( $\overline{LE}/HYS$ )                                        | $V_{EE} - 0.3$     | $V_{CCO} + 0.3$    | V    |
| Current into Input pins (IN+, IN-, $\overline{SHDN}$ , $\overline{LE}/HYS$ ) <sup>(2)</sup> | -10                | +10                | mA   |
| Current into Output pins (OUT+, OUT-) <sup>(3)</sup>                                        | -10                | +10                | mA   |
| Junction temperature, $T_J$                                                                 |                    | 150                | °C   |
| Storage temperature, $T_{stg}$                                                              | -65                | 150                | °C   |

- Operation outside the Absolute Maximum Ratings may cause permanent device damage. Absolute Maximum Ratings do not imply functional operation of the device at these or any other conditions beyond those listed under Recommended Operating Conditions. If used outside the Recommended Operating Conditions but within the Absolute Maximum Ratings, the device may not be fully functional, and this may affect device reliability, functionality, performance, and shorten the device lifetime.
- Input terminals are diode-clamped to the power-supply rails. Input signals that can swing more than 0.3V beyond the supply rails or 6V, whichever is lower, must be current-limited to 10mA or less.
- Output terminals are diode-clamped to the power-supply rails. Output signals that can swing more than 0.3V beyond the supply rails must be current-limited to 10mA or less.

### 5.2 ESD Ratings

|             |                         | VALUE                                                                              | UNIT  |
|-------------|-------------------------|------------------------------------------------------------------------------------|-------|
| $V_{(ESD)}$ | Electrostatic discharge | TLV3604 Human-body model (HBM), per ANSI/ESDA/JEDEC JS-001 <sup>(1)</sup>          | ±1500 |
|             |                         | TLV3605, TLV3607 Human-body model (HBM), per ANSI/ESDA/JEDEC JS-001 <sup>(1)</sup> | ±2000 |
|             |                         | Charged-device model (CDM), per JEDEC specification JESD22-C101 <sup>(2)</sup>     | ±1000 |

- JEDEC document JEP155 states that 500V HBM allows safe manufacturing with a standard ESD control process.
- JEDEC document JEP157 states that 250V CDM allows safe manufacturing with a standard ESD control process.

### 5.3 Recommended Operating Conditions

over operating free-air temperature range (unless otherwise noted)

|                                                      | MIN            | MAX             | UNIT |
|------------------------------------------------------|----------------|-----------------|------|
| Input Supply Voltage: $V_{CCI} - V_{EE}$             | 2.4            | 5.5             | V    |
| Output Supply Voltage: $V_{CCO} - V_{EE}$            | 2.4            | 5.5             | V    |
| Input Voltage Range (IN+, IN-)                       | $V_{EE} - 0.3$ | $V_{CCI} + 0.3$ | V    |
| Shutdown Enable ( $\overline{SHDN}$ )                | $V_{EE} - 0.3$ | $V_{CCO} + 0.3$ | V    |
| Latch and Hysteresis Control ( $\overline{LE}/HYS$ ) | $V_{EE} - 0.3$ | $V_{CCO} + 0.3$ | V    |
| Ambient temperature, $T_A$                           | -40            | 125             | °C   |

## 5.4 Thermal Information

| THERMAL METRIC          |                                              | TLV3604    | TLV3605    | TLV3607    | UNIT |
|-------------------------|----------------------------------------------|------------|------------|------------|------|
|                         |                                              | DCK (SC70) | RVK (WQFN) | RTE (WQFN) |      |
|                         |                                              | 6 PINS     | 12 PINS    | 16 PINS    |      |
| $R_{\theta JA}$         | Junction-to-ambient thermal resistance       | 170.3      | 85.8       | 72.1       | °C/W |
| $R_{\theta JC(top)}$    | Junction-to-case (top) thermal resistance    | 134.5      | 71.6       | 53.8       | °C/W |
| $R_{\theta JC(bottom)}$ | Junction-to-case (bottom) thermal resistance | N/A        | 15.1       | 35.7       | °C/W |
| $R_{\theta JB}$         | Junction-to-board thermal resistance         | 63.3       | 52.7       | 45.9       | °C/W |
| $\psi_{JT}$             | Junction-to-top characterization parameter   | 43.7       | 4.1        | 2.1        | °C/W |
| $\psi_{JB}$             | Junction-to-board characterization parameter | 63.1       | 52.7       | 45.9       | °C/W |

## 5.5 Electrical Characteristics ( $V_{CCI} = V_{CCO} = 2.5V$ to $5V$ )

$V_{CCI} = V_{CCO} = 2.5$  to  $5V$ ,  $V_{EE} = 0V$ ,  $V_{CM} = V_{EE} + 300mV$ ,  $R_{LOAD} = 100\Omega$ ,  $C_L = 1pF$  probe capacitance, typical at  $T_A = 25^\circ C$  (unless otherwise noted).

| PARAMETER                        |                                              | TEST CONDITIONS                                                                                                                | MIN            | TYP       | MAX             | UNIT       |
|----------------------------------|----------------------------------------------|--------------------------------------------------------------------------------------------------------------------------------|----------------|-----------|-----------------|------------|
| <b>DC Input Characteristics</b>  |                                              |                                                                                                                                |                |           |                 |            |
| $V_{IO}$ (1)                     | Input offset voltage                         | $V_{CCI} = V_{CCO} = 2.5V$ and $5V$<br>$T_A = -40^\circ C$ to $+125^\circ C$                                                   | -5             | $\pm 0.5$ | 5               | mV         |
| $V_{CM}$                         | Input common mode voltage range              | $V_{CCI} = V_{CCO} = 2.5V$ and $5V$<br>$T_A = -40^\circ C$ to $+125^\circ C$                                                   | $V_{EE} - 0.2$ |           | $V_{CCI} + 0.2$ | V          |
| $V_{HYST}$                       | Input hysteresis voltage                     |                                                                                                                                |                | 0         |                 | mV         |
| $C_{IN}$                         | Input capacitance                            |                                                                                                                                |                | 1         |                 | pF         |
| $R_{DM}$                         | Input differential mode resistance           |                                                                                                                                |                | 67        |                 | k $\Omega$ |
| $R_{CM}$                         | Input common mode resistance                 |                                                                                                                                |                | 5         |                 | M $\Omega$ |
| $I_B$                            | Input bias current                           | $V_{CCI} = V_{CCO} = 2.5V$ and $5V$<br>$T_A = -40^\circ C$ to $+125^\circ C$                                                   | -5             | -1        | 5               | $\mu A$    |
| $I_{OS}$                         | Input offset current                         | $V_{CCI} = V_{CCO} = 2.5V$ and $5V$<br>$T_A = -40^\circ C$ to $+125^\circ C$                                                   | -1             |           | 1               | $\mu A$    |
| CMRR (1)                         | Common-mode rejection ratio                  | $V_{CCI} = V_{CCO} = 2.5V$ and $5V$<br>$V_{CM} = V_{EE} - 0.2V$ to $V_{CCI} + 0.2V$ ,<br>$T_A = -40^\circ C$ to $+125^\circ C$ | 50             | 80        |                 | dB         |
| PSRR (1)                         | Power-supply rejection ratio                 | $V_{CCI} = V_{CCO} = 2.5V$ to $5V$ ,<br>$T_A = -40^\circ C$ to $+125^\circ C$                                                  | 55             | 80        |                 | dB         |
| <b>DC Output Characteristics</b> |                                              |                                                                                                                                |                |           |                 |            |
| $V_{OCM}$                        | Output common mode voltage                   | $V_{CCI} = V_{CCO} = 2.5V$ and $5V$<br>$T_A = -40^\circ C$ to $+125^\circ C$                                                   | 1.125          | 1.2       | 1.375           | V          |
| $\Delta V_{OCM}$                 | Output common mode voltage mismatch          | $V_{CCI} = V_{CCO} = 2.5V$ and $5V$<br>$T_A = -40^\circ C$ to $+125^\circ C$                                                   |                |           | 50              | mV         |
| $V_{OCM\_PP}$                    | Peak-to-Peak output common mode voltage      |                                                                                                                                |                | 20        |                 | mVpp       |
| $V_{OD}$                         | Differential output voltage                  | $V_{CCI} = V_{CCO} = 2.5V$ and $5V$<br>$T_A = -40^\circ C$ to $+125^\circ C$                                                   | 250            | 350       | 450             | mV         |
| $\Delta V_{OD}$                  | Differential output voltage mismatch         | $V_{CCI} = V_{CCO} = 2.5V$ and $5V$<br>$T_A = -40^\circ C$ to $+125^\circ C$                                                   |                |           | 10              | mV         |
| <b>Power Supply</b>              |                                              |                                                                                                                                |                |           |                 |            |
| $I_{CC}$ (TLV3604)               | Total quiescent current                      | $V_{CCI} = V_{CCO} = 2.5V$ and $5V$<br>$T_A = -40^\circ C$ to $+125^\circ C$                                                   |                | 12.1      | 16.5            | mA         |
| $I_{CCI}$ (TLV3605)              | Input stage quiescent current                | $V_{CCI} = V_{CCO} = 2.5V$ and $5V$<br>$T_A = -40^\circ C$ to $+125^\circ C$                                                   |                | 7.5       | 10.5            | mA         |
| $I_{CCO}$ (TLV3605)              | Output stage quiescent current               | $V_{CCI} = V_{CCO} = 2.5V$ and $5V$<br>$T_A = -40^\circ C$ to $+125^\circ C$                                                   |                | 5.2       | 7.0             | mA         |
| $I_{CCI}$ (TLV3607)              | Input stage quiescent current per channel    | $V_{CCI} = V_{CCO} = 2.5V$ and $5V$<br>$T_A = -40^\circ C$ to $+125^\circ C$                                                   |                | 7.5       | 10.5            | mA         |
| $I_{CCO}$ (TLV3607)              | Output stage quiescent current per channel   | $V_{CCI} = V_{CCO} = 2.5V$ and $5V$<br>$T_A = -40^\circ C$ to $+125^\circ C$                                                   |                | 5.2       | 7.0             | mA         |
| <b>AC Characteristics</b>        |                                              |                                                                                                                                |                |           |                 |            |
| $t_{PD}$                         | Propagation delay                            | $V_{OVERDRIVE} = V_{UNDERDRIVE} = 50mV$ , 50MHz Squarewave                                                                     |                | 800       |                 | ps         |
| $t_{PD\_SKEW}$                   | Propagation delay skew                       | $V_{OVERDRIVE} = V_{UNDERDRIVE} = 50mV$ , 50MHz Squarewave                                                                     |                | 40        |                 | ps         |
| $\Delta t_{PD}$ (TLV3607 only)   | Channel-to-channel propagation delay skew(2) | $V_{OVERDRIVE} = V_{UNDERDRIVE} = 50mV$ , 50MHz Squarewave                                                                     |                | 10        |                 | ps         |
| $t_{CM\_DISPERSION}$             | Common dispersion                            | $V_{CM}$ varied from $V_{EE}$ to $V_{CCI}$                                                                                     |                | 200       |                 | ps         |
| $t_{OD\_DISPERSION}$             | Overdrive dispersion                         | Overdrive varied from 10mV to 250mV                                                                                            |                | 350       |                 | ps         |
| $t_{UD\_DISPERSION}$             | Underdrive dispersion                        | Underdrive varied from 10mV to 250mV                                                                                           |                | 200       |                 | ps         |
| $t_R$                            | Rise time                                    | 20% to 80%                                                                                                                     |                | 350       |                 | ps         |
| $t_F$                            | Fall time                                    | 80% to 20%                                                                                                                     |                | 350       |                 | ps         |
| $f_{TOGGLE}$                     | Input toggle frequency                       | $V_{IN} = 200mV_{PP}$ Sine Wave, 50% Output swing                                                                              |                | 1.5       |                 | GHz        |

## 5.5 Electrical Characteristics ( $V_{CCI} = V_{CCO} = 2.5V$ to $5V$ ) (continued)

$V_{CCI} = V_{CCO} = 2.5$  to  $5V$ ,  $V_{EE} = 0V$ ,  $V_{CM} = V_{EE} + 300mV$ ,  $R_{LOAD} = 100\Omega$ ,  $C_L = 1pF$  probe capacitance, typical at  $T_A = 25^\circ C$  (unless otherwise noted).

| PARAMETER                                                   |                                                             | TEST CONDITIONS                                                                                    | MIN | TYP | MAX  | UNIT    |
|-------------------------------------------------------------|-------------------------------------------------------------|----------------------------------------------------------------------------------------------------|-----|-----|------|---------|
| TR                                                          | Toggle rate                                                 | $V_{IN} = 200mV_{PP}$ Sine Wave, 50% Output swing                                                  |     | 3.0 |      | Gbps    |
| $f_{TOGGLE}$ (TLV3607 only)                                 | Input toggle frequency                                      | $V_{IN} = 200mV_{PP}$ Sine Wave, 50% Output swing                                                  |     | 1.3 |      | GHz     |
| TR (TLV3607 only)                                           | Toggle rate                                                 | $V_{IN} = 200mV_{PP}$ Sine Wave, 50% Output swing                                                  |     | 2.6 |      | Gbps    |
| PulseWidth                                                  | Minimum allowed input pulse width                           | $V_{OVERDRIVE} = V_{UNDERDRIVE} = 50mV$<br>$PW_{OUT} = 90\%$ of $PW_{IN}$                          |     | 600 |      | ps      |
| <b>Latching/Adjustable Hysteresis (TLV3605 and TLV3607)</b> |                                                             |                                                                                                    |     |     |      |         |
| $V_{HYST}$                                                  | Input hysteresis voltage                                    | $R_{HYST} = \text{Floating}$                                                                       |     | 0   |      | mV      |
| $V_{HYST}$                                                  | Input hysteresis voltage                                    | $R_{HYST} = 150k\Omega$                                                                            |     | 30  |      | mV      |
| $V_{HYST}$                                                  | Input hysteresis voltage                                    | $R_{HYST} = 56k\Omega$                                                                             |     | 60  |      | mV      |
| $V_{IH\_LE}$                                                | $\overline{LE}$ pin input high level                        | $V_{CCI} = V_{CCO} = 2.5V$ and $5V$<br>$T_A = -40^\circ C$ to $+125^\circ C$                       | 1.5 |     |      | V       |
| $V_{IL\_LE}$                                                | $\overline{LE}$ pin input low level                         | $V_{CCI} = V_{CCO} = 2.5V$ and $5V$<br>$T_A = -40^\circ C$ to $+125^\circ C$                       |     |     | 0.35 | V       |
| $I_{IH\_LE}$                                                | $\overline{LE}$ pin input leakage current                   | $V_{LE} = V_{CCO}$<br>$T_A = -40^\circ C$ to $+125^\circ C$                                        |     |     | 3.5  | $\mu A$ |
| $I_{IL\_LE}$                                                | $\overline{LE}$ pin input leakage current                   | $V_{LE} = V_{EE}$<br>$T_A = -40^\circ C$ to $+125^\circ C$                                         |     |     | 40   | $\mu A$ |
| $t_{SETUP}$                                                 | Latch setup time                                            |                                                                                                    |     | -3  |      | ns      |
| $t_{HOLD}$                                                  | Latch hold time                                             |                                                                                                    |     | 6   |      | ns      |
| $t_{PL}$                                                    | Latch to Q and $\overline{Q}$ delay                         |                                                                                                    |     | 4   |      | ns      |
| <b>Shutdown Characteristics (TLV3605 and TLV3607)</b>       |                                                             |                                                                                                    |     |     |      |         |
| $V_{IH\_SD}$                                                | $\overline{SHDN}$ pin input high level                      | $V_{CCI} = V_{CCO} = 2.5V$ and $5V$<br>$T_A = -40^\circ C$ to $+125^\circ C$                       | 1.5 |     |      | V       |
| $V_{IL\_SD}$                                                | $\overline{SHDN}$ pin input low level                       | $V_{CCI} = V_{CCO} = 2.5V$ and $5V$<br>$T_A = -40^\circ C$ to $+125^\circ C$                       |     |     | 0.4  | V       |
| $I_{IH\_SD}$                                                | $\overline{SHDN}$ pin input leakage current                 | $V_{CCI} = V_{CCO} = 2.5V$ and $5V$<br>$V_{SD} = V_{CCO}$<br>$T_A = -40^\circ C$ to $+125^\circ C$ |     |     | 2    | $\mu A$ |
| $I_{IL\_SD}$                                                | $\overline{SHDN}$ pin input leakage current                 | $V_{CCI} = V_{CCO} = 2.5V$ and $5V$<br>$V_{SD} = V_{EE}$<br>$T_A = -40^\circ C$ to $+125^\circ C$  |     |     | 30   | $\mu A$ |
| $I_{CCI\_SD}$                                               | Input stage quiescent current per channel in Shutdown mode  | $V_{CCI} = V_{CCO} = 2.5V$ and $5V$<br>$V_{LE} = V_{CCO}$<br>$T_A = -40^\circ C$ to $+125^\circ C$ |     |     | 1.5  | mA      |
| $I_{CCO\_SD}$                                               | Output stage quiescent current per channel in Shutdown mode | $V_{CCI} = V_{CCO} = 2.5V$ and $5V$<br>$T_A = -40^\circ C$ to $+125^\circ C$                       |     |     | 100  | $\mu A$ |
| $t_{SLEEP}$                                                 | Sleep time from Active to Shutdown mode                     | 10% output swing                                                                                   |     | 8   |      | ns      |
| $t_{WAKEUP}$                                                | Wake up time from Shutdown mode                             | $V_{OD} = 50mV$ , output valid                                                                     |     | 100 |      | ns      |

- For TLV3605 and TLV3607, the  $V_{IO}$  is tested with  $R_{HYST} = 150k\Omega$
- Differential propagation delay is defined as the larger of the two:  
 $\Delta t_{PDLH} = t_{PDLH}(MAX) - t_{PDLH}(MIN)$   
 $\Delta t_{PDHL} = t_{PDHL}(MAX) - t_{PDHL}(MIN)$   
 where (MAX) and (MIN) denote the maximum and minimum values of a given measurement across the different comparator channels.



### 5.6 Typical Characteristics

At  $T_A = 25^\circ\text{C}$ ,  $V_{CC1}/V_{CC0} = 2.5\text{V to }5.0\text{V}$ ,  $V_{CM} = 0.3\text{V}$ , and input overdrive/underdrive = 50mV unless otherwise noted.

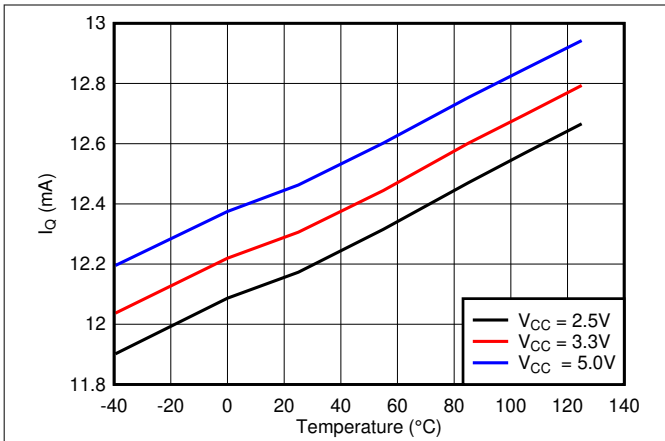

Figure 5-1. I<sub>Q</sub> vs Temperature

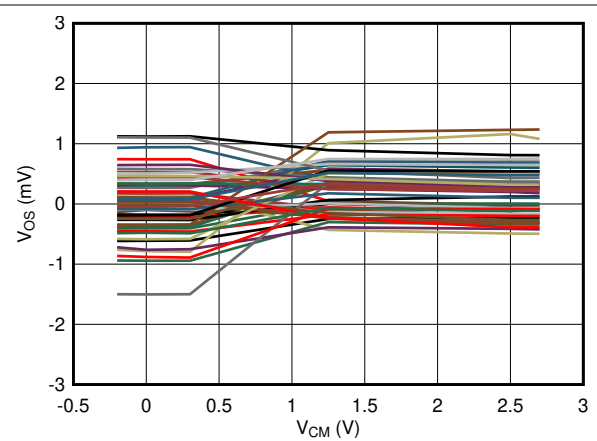

Figure 5-2. V<sub>OS</sub> vs V<sub>CM</sub> @ V<sub>CC</sub> = 2.5V - 50 Devices

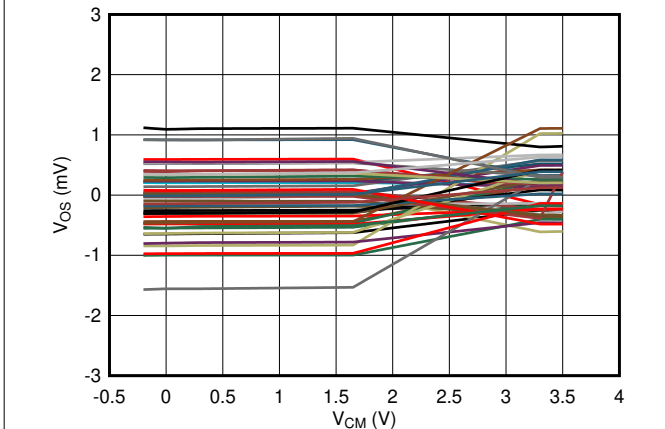

Figure 5-3. V<sub>OS</sub> vs V<sub>CM</sub> @ V<sub>CC</sub> = 3.3V - 50 Devices

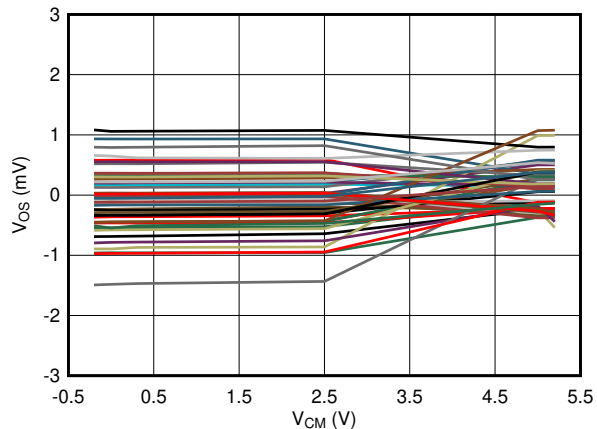

Figure 5-4. V<sub>OS</sub> vs V<sub>CM</sub> @ V<sub>CC</sub> = 5.0V - 50 Devices

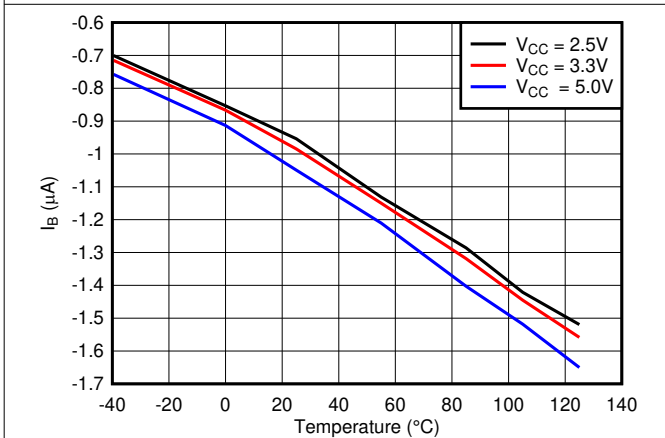

Figure 5-5. Bias Current vs Temperature

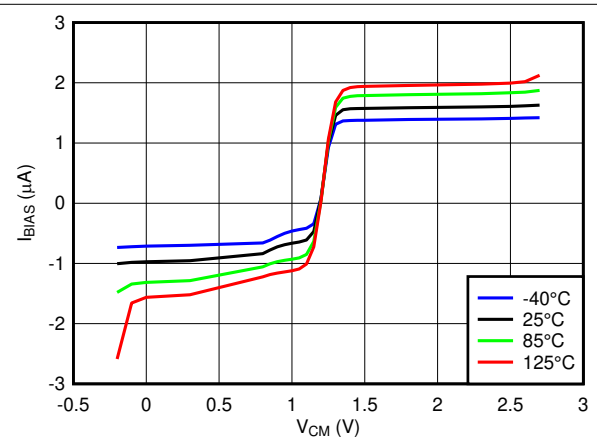

Figure 5-6. Input Bias Current vs V<sub>CM</sub> @ V<sub>CC</sub> = 2.5V

### 5.6 Typical Characteristics (continued)

At  $T_A = 25^\circ\text{C}$ ,  $V_{CCI}/V_{CCO} = 2.5\text{V}$  to  $5.0\text{V}$ ,  $V_{CM} = 0.3\text{V}$ , and input overdrive/underdrive =  $50\text{mV}$  unless otherwise noted.

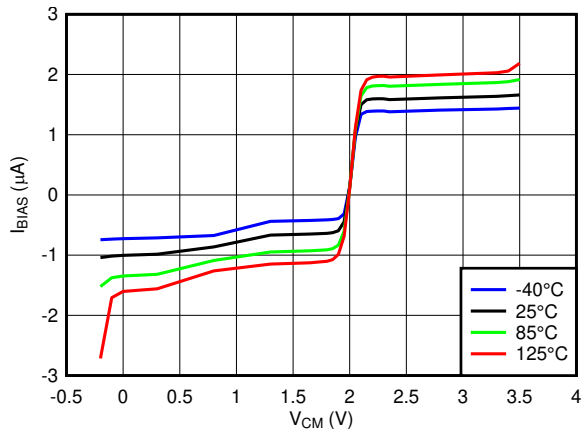

Figure 5-7. Input Bias Current vs  $V_{CM}$  @  $V_{CC} = 3.3\text{V}$

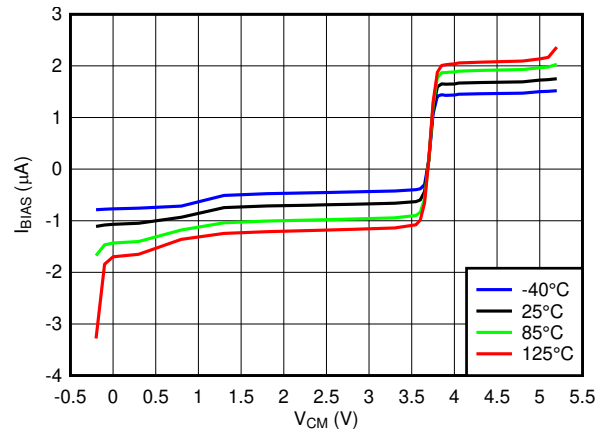

Figure 5-8. Input Bias Current vs  $V_{CM}$  @  $V_{CC} = 5.0\text{V}$

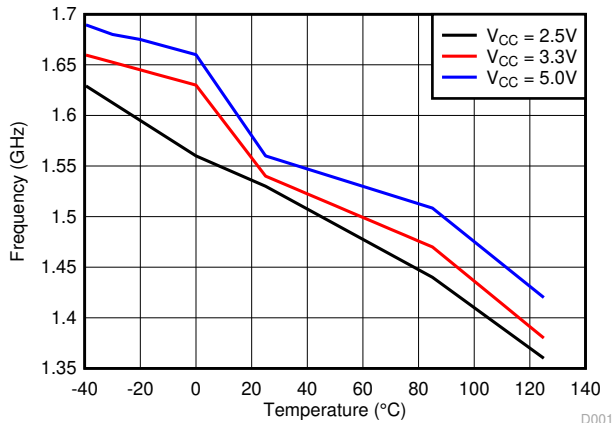

Figure 5-9. FToggle vs Temperature

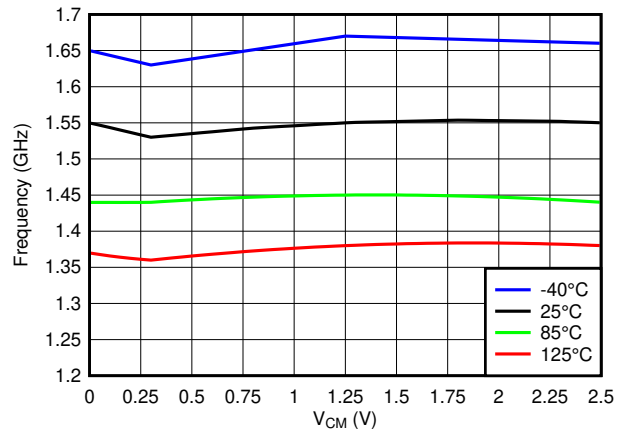

Figure 5-10. Ftoggle vs  $V_{CM}$  @  $V_{CC} = 2.5\text{V}$

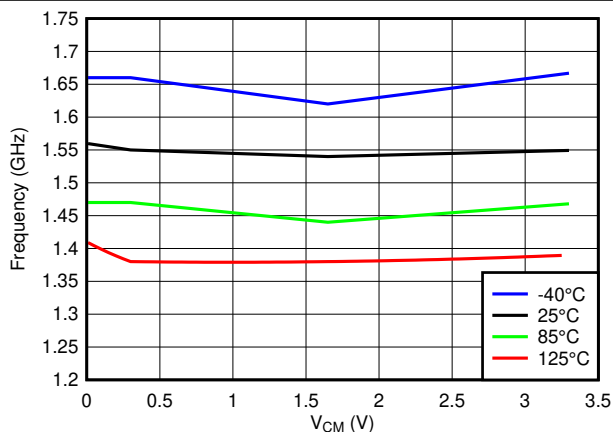

Figure 5-11. Ftoggle vs  $V_{CM}$  @  $V_{CC} = 3.3\text{V}$

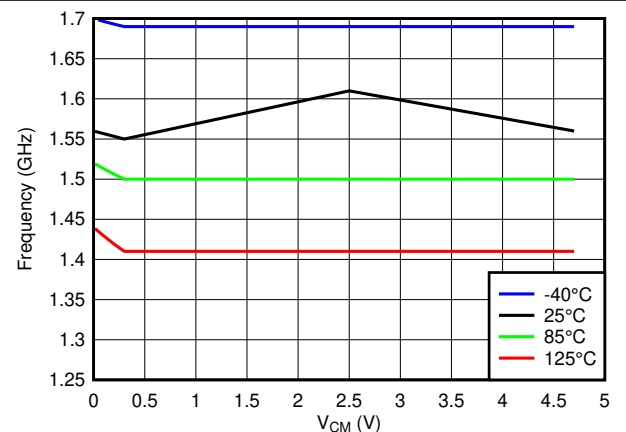

Figure 5-12. Ftoggle vs  $V_{CM}$  @  $V_{CC} = 5.0\text{V}$

## 5.6 Typical Characteristics (continued)

At  $T_A = 25^\circ\text{C}$ ,  $V_{CC1}/V_{CC0} = 2.5\text{V to }5.0\text{V}$ ,  $V_{CM} = 0.3\text{V}$ , and input overdrive/underdrive = 50mV unless otherwise noted.

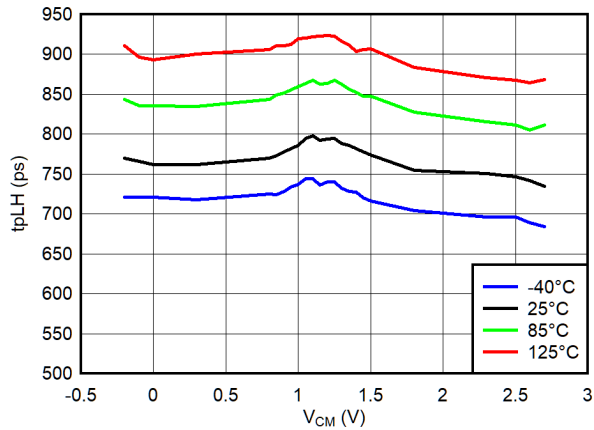

Figure 5-13.  $T_{PLH}$  vs  $V_{CM}$  @  $V_{CC} = 2.5\text{V}$

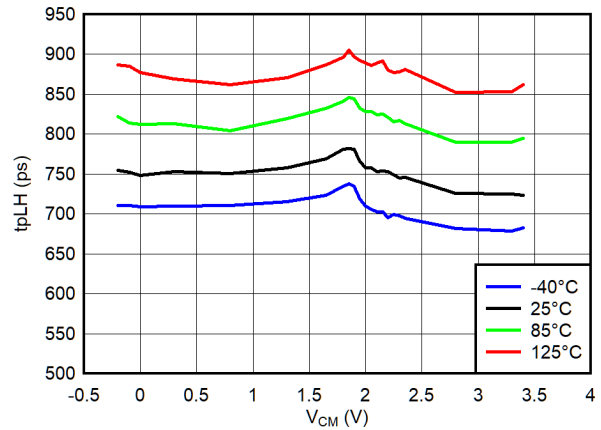

Figure 5-14.  $T_{PLH}$  vs  $V_{CM}$  @  $V_{CC} = 3.3\text{V}$

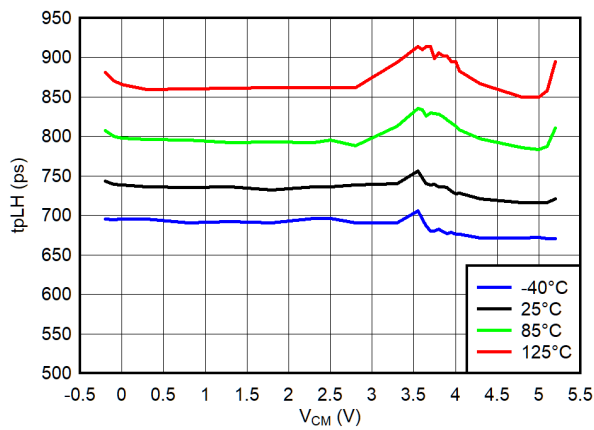

Figure 5-15.  $T_{PLH}$  vs  $V_{CM}$  @  $V_{CC} = 5.0\text{V}$

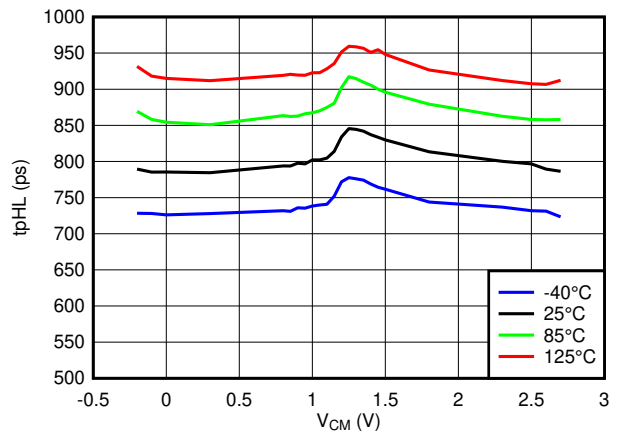

Figure 5-16.  $T_{PHL}$  vs  $V_{CM}$  @  $V_{CC} = 2.5\text{V}$

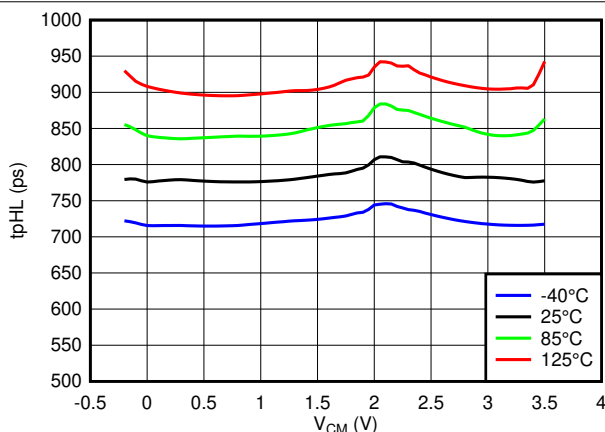

Figure 5-17.  $T_{PHL}$  vs  $V_{CM}$  @  $V_{CC} = 3.3\text{V}$

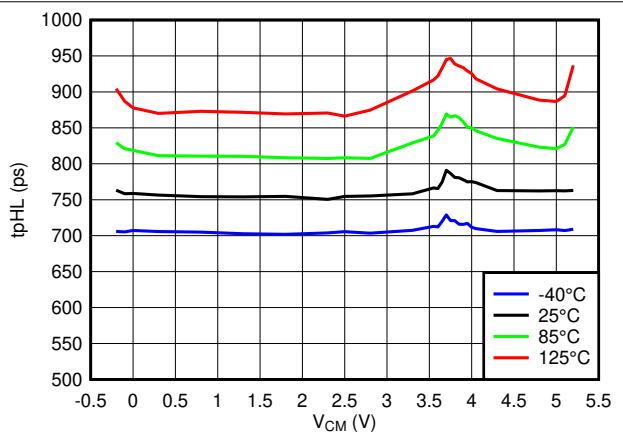

Figure 5-18.  $T_{PHL}$  vs  $V_{CM}$  @  $V_{CC} = 5.0\text{V}$

### 5.6 Typical Characteristics (continued)

At  $T_A = 25^\circ\text{C}$ ,  $V_{CC1}/V_{CC0} = 2.5\text{V to }5.0\text{V}$ ,  $V_{CM} = 0.3\text{V}$ , and input overdrive/underdrive = 50mV unless otherwise noted.

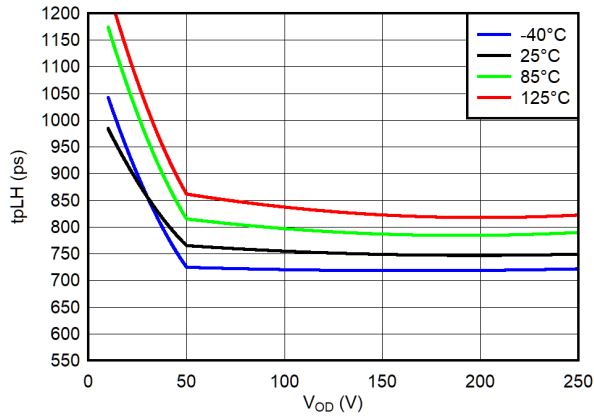

Figure 5-19.  $T_{PLH}$  vs Input Overdrive @  $V_{CC} = 2.5\text{V}$

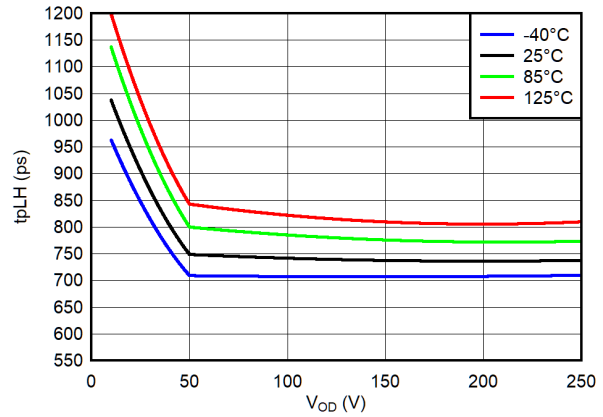

Figure 5-20.  $T_{PLH}$  vs Input Overdrive @  $V_{CC} = 3.3\text{V}$

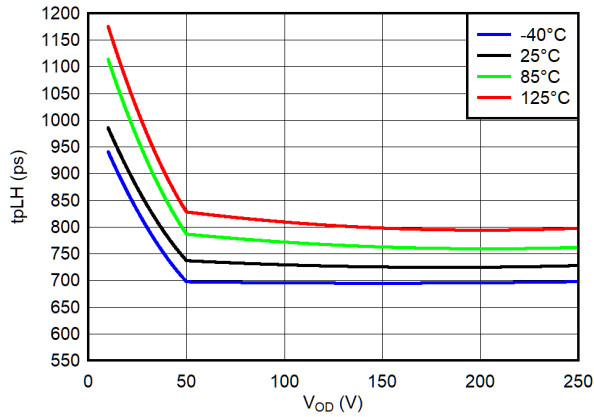

Figure 5-21.  $T_{PLH}$  vs Input Overdrive @  $V_{CC} = 5.0\text{V}$

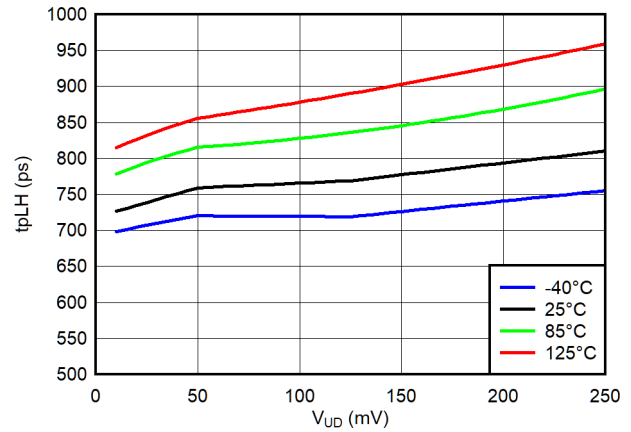

Figure 5-22.  $T_{PLH}$  vs Input Underdrive @  $V_{CC} = 2.5\text{V}$

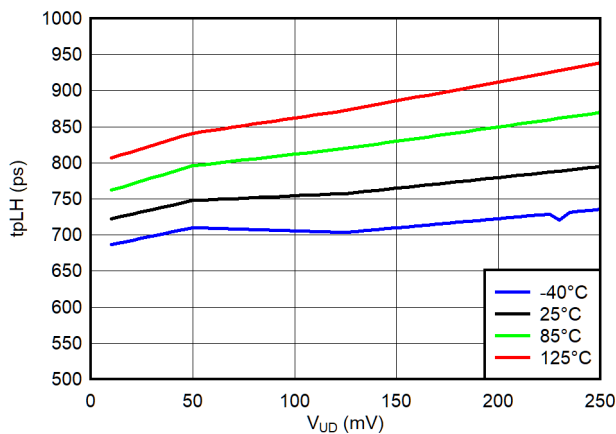

Figure 5-23.  $T_{PLH}$  vs Input Underdrive @  $V_{CC} = 3.3\text{V}$

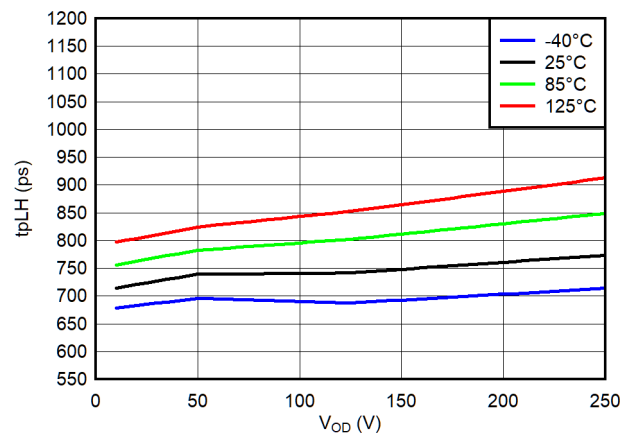

Figure 5-24.  $T_{PLH}$  vs Input Underdrive @  $V_{CC} = 5.0\text{V}$

## 6 Detailed Description

### 6.1 Overview

The TLV3604, TLV3605, and TLV3607 are 800ps, high-speed comparators with LVDS outputs and rail-to-rail inputs. These features, along with an operating voltage range of 2.4V to 5.5V and a high toggle frequency of 3Gbps, make the TLV3604, TLV3605, and TLV3607 well suited for LIDAR, clock and data recovery applications, and test and measurement systems.

### 6.2 Functional Block Diagram

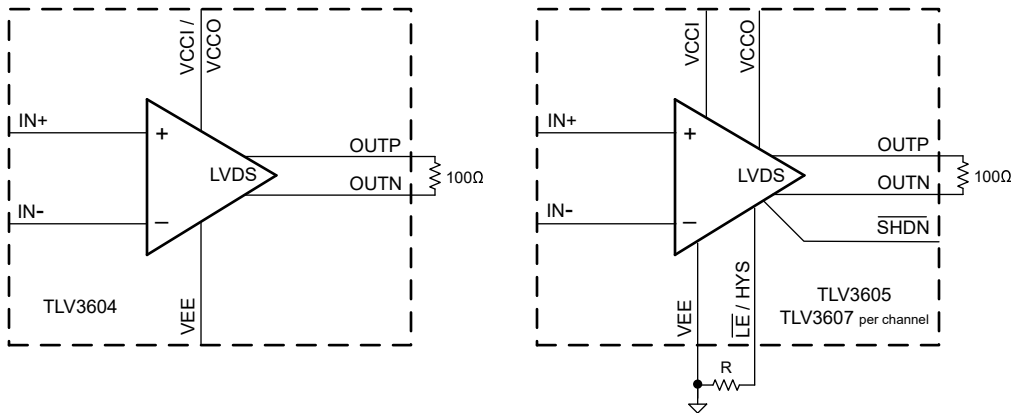

### 6.3 Feature Description

The TLV3604 and TLV3605 (single channel) and TLV3607 (dual channel) are high-speed comparators with rail-to-rail inputs and LVDS outputs. The rail-to-rail input stage is capable of operating up to 200mV beyond each power supply rail with minimal input offset. The TLV3605 (single) and TLV3607 (dual) have similar performance as the TLV3604 while providing adjustable hysteresis, latching function, and shutdown mode.

### 6.4 Device Functional Modes

The TLV3604 has a single functional mode and is operational when the power supply voltage is greater than the minimum operating voltage. The TLV3605 and TLV3607 have an active and shutdown mode. The TLV3605 and TLV3607 are in shutdown mode when the SHDN pin is logic low. To allow for easy interface with 1.8V FPGAs and CPUs, the SHDN pin is 1.8V logic compliant and independent of the comparator power supply.

#### 6.4.1 Rail-to-Rail Inputs

The TLV3604, TLV3605, and TLV3607 feature input stages capable of operating 200mV below or above the power supply rails, allowing for zero cross detection and maximizing input dynamic range. With low input offset voltage, the comparators improve system performance in high sensitivity signal detection.

#### 6.4.2 LVDS Output

The TLV3604, TLV3605, and TLV3607 outputs are LVDS compliant. When the input of the downstream device is terminated with a 100Ω resistor, it provides a ±350mV LVDS swing. Fully differential outputs enable fast digital toggling and reduce EMI compared to single-ended output standards.

## 7 Application and Implementation

---

### Note

Information in the following applications sections is not part of the TI component specification, and TI does not warrant its accuracy or completeness. TI's customers are responsible for determining suitability of components for their purposes, as well as validating and testing their design implementation to confirm system functionality.

---

### 7.1 Application Information

The TLV3604, TLV3605, and TLV3607 comparators feature rail-to-rail inputs and a LVDS output stage that is well-suited for high speed applications that require low power consumption. The 800ps propagation delay of the comparators improve performance and extend the range for applications involving optical reception, triggers for test and measurement systems, and transceivers that require a high speed signal to be carried over a certain distance.

#### 7.1.1 Comparator Inputs

The TLV3604, TLV3605, and TLV3607 are rail-to-rail input comparators, with an input common-mode range that exceeds the supply rails by 200mV for both positive and negative supplies.

#### 7.1.2 Capacitive Loads

Under reasonable capacitive loads, the device maintains specified propagation delay. However, excessive capacitive loading under high switching frequencies may increase supply current, propagation delay, or induce decreased slew rate.

#### 7.1.3 Latch Functionality

The latch pin for the TLV3605 and TLV3607 holds the output state of the device when the voltage at the LEB/HYST pin is less than 800mV above  $V_{EE}$ . This is particularly useful when the output state is intended to remain unchanged. An important consideration of the latch functionality is the latch hold time. Latch hold time is the minimum time (after the latch pin is asserted) required for properly latching the comparator output.

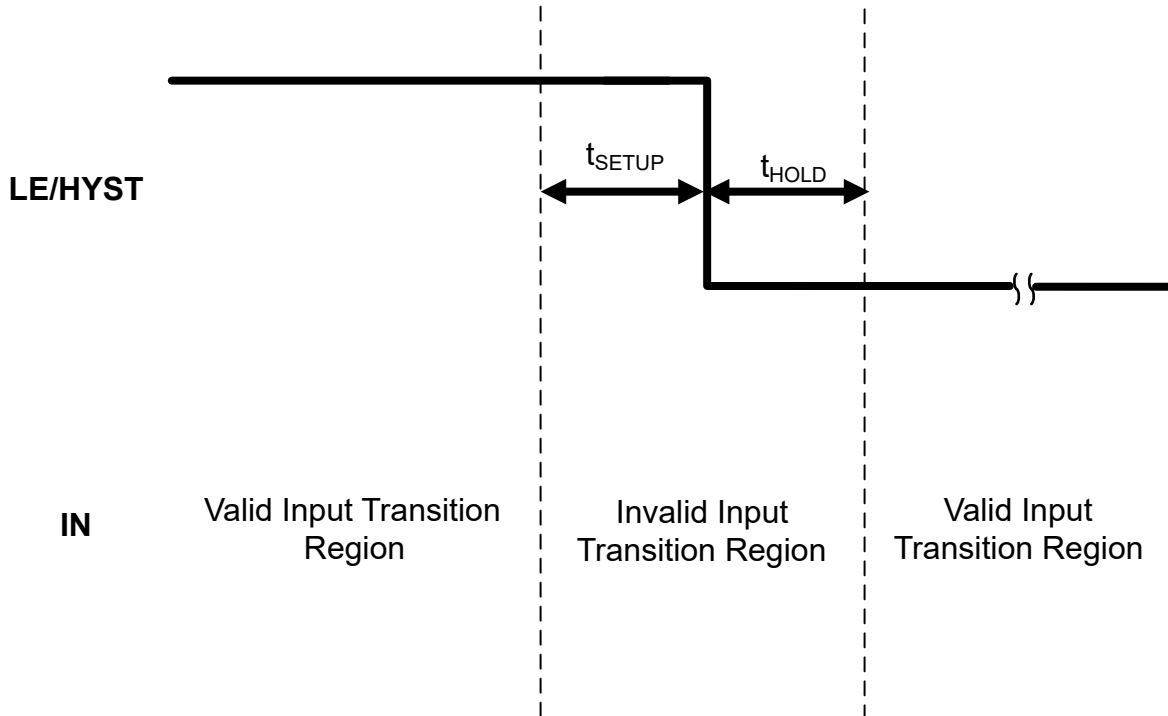

Figure 7-1. Valid Latch Diagram

Likewise, latch setup time is defined as the time that the input must be stable before the latch pin is asserted low. The figure above illustrates when the input can transition for a valid latch. Note that the typical setup time in the EC table is negative; this is due to the internal trace delays of the LEB/HYST pin relative to the input pin trace delays.

A small delay in the output response is shown below when the TLV3605 and TLV3607 exits a latched output stage.

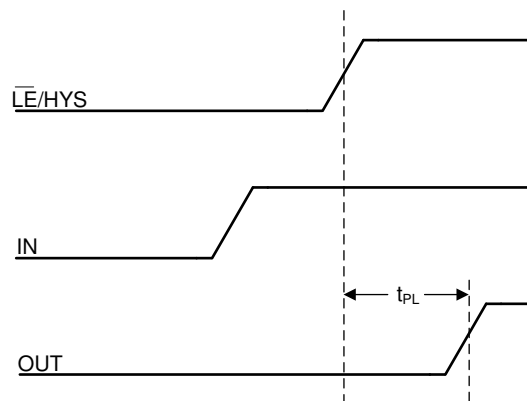

Figure 7-2. Latch Disable with Input Change

#### 7.1.4 Adjustable Hysteresis

As a result of a comparator’s high open loop gain, there is a small band of input differential voltage where the output can toggle back and forth between “logic high” and “logic low” states. This can cause design challenges for inputs with slow rise and fall times or systems with excessive noise.

These challenges can be overcome by adding hysteresis to the comparator. Since the TLV3604 does not have internal hysteresis, external hysteresis can be applied in the form of a positive feedback loop that adjusts the

trip point of the comparator depending on its current output state. See the Typical Application section for more details.

The TLV3605 and TLV3607 have a LEB/HYST pin that can be used to increase the internal hysteresis of the comparator. To change the internal hysteresis of the TLV3605 and TLV3607, connect a single resistor as shown in the [adjusting hysteresis figure](#) between the LEB/HYST pin and VEE. A curve of hysteresis versus resistance is provided below to provide guidance in setting the desired amount of hysteresis.

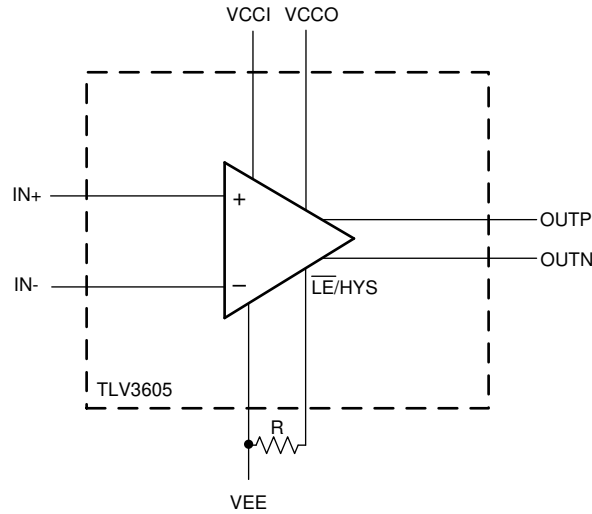

**Figure 7-3. Adjusting Hysteresis with an External Resistor (R)**

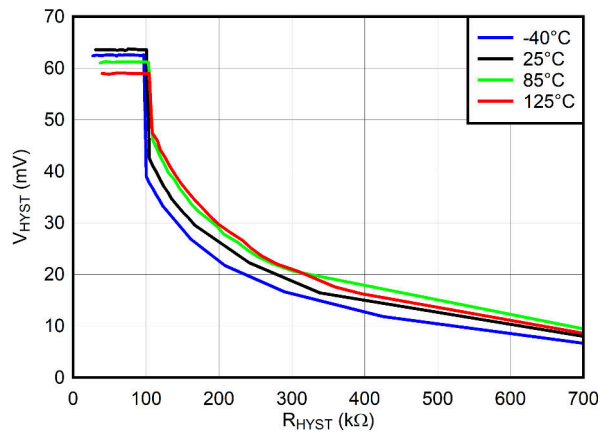

**Figure 7-4. V<sub>HYST</sub> (mV) vs R<sub>HYST</sub> (kΩ), V<sub>CC</sub> = 3.3V**

## 7.2 Typical Application

### 7.2.1 Non-Inverting Comparator With Hysteresis

A way to implement external hysteresis is to add two resistors to the circuit: one in series between the reference voltage and the inverting pin, and another from the inverting pin to one of the differential output pins.



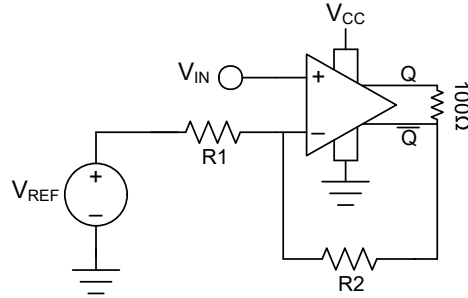

**Figure 7-5. Non-Inverting Comparator with Hysteresis Circuit**

### 7.2.1.1 Design Requirements

**Table 7-1. Design Parameters**

| PARAMETER | VALUE  |
|-----------|--------|
| $V_{HYS}$ | 50mV   |
| $V_{REF}$ | 2.5V   |
| $V_{T1}$  | 2.34V  |
| $V_{T2}$  | 2.29V  |
| Q         | 1.375V |
| $\bar{Q}$ | 1.025V |

### 7.2.1.2 Detailed Design Procedure

First, create an equation for  $V_T$  that covers both output voltages when the output is high or low.

$$V_{T1} = \frac{V_{REF}R_2 + QR_1}{R_1 + R_2} \quad (1)$$

$$V_{T2} = \frac{V_{REF}R_2 + \bar{Q}R_1}{R_1 + R_2} \quad (2)$$

The hysteresis voltage in this network is equal to the difference in the two threshold voltage equations.

$$V_{HYS} = V_{T1} - V_{T2} \quad (3)$$

$$V_{HYS} = \frac{V_{REF}R_2 + QR_1}{R_1 + R_2} - \frac{V_{REF}R_2 + \bar{Q}R_1}{R_1 + R_2} \quad (4)$$

$$V_{HYS} = \frac{(Q - \bar{Q})R_1}{R_1 + R_2} \quad (5)$$

$$V_{HYS} = \frac{V_{OD}R_1}{R_1 + R_2} \quad (6)$$

Note that these equations do not take into account the effects of the internal hysteresis and offset voltage of the comparator. Design parameters need to be adjusted accordingly.

Select a value for R2. Plug in given values for  $V_{REF}$ ,  $V_{T1}$ ,  $V_{T2}$ , Q, and  $\bar{Q}$ , and solve for R1. For the given example, R2 = 50kΩ, and R1 is solved as = 8.3kΩ.

### 7.2.1.3 Application Performance Plots

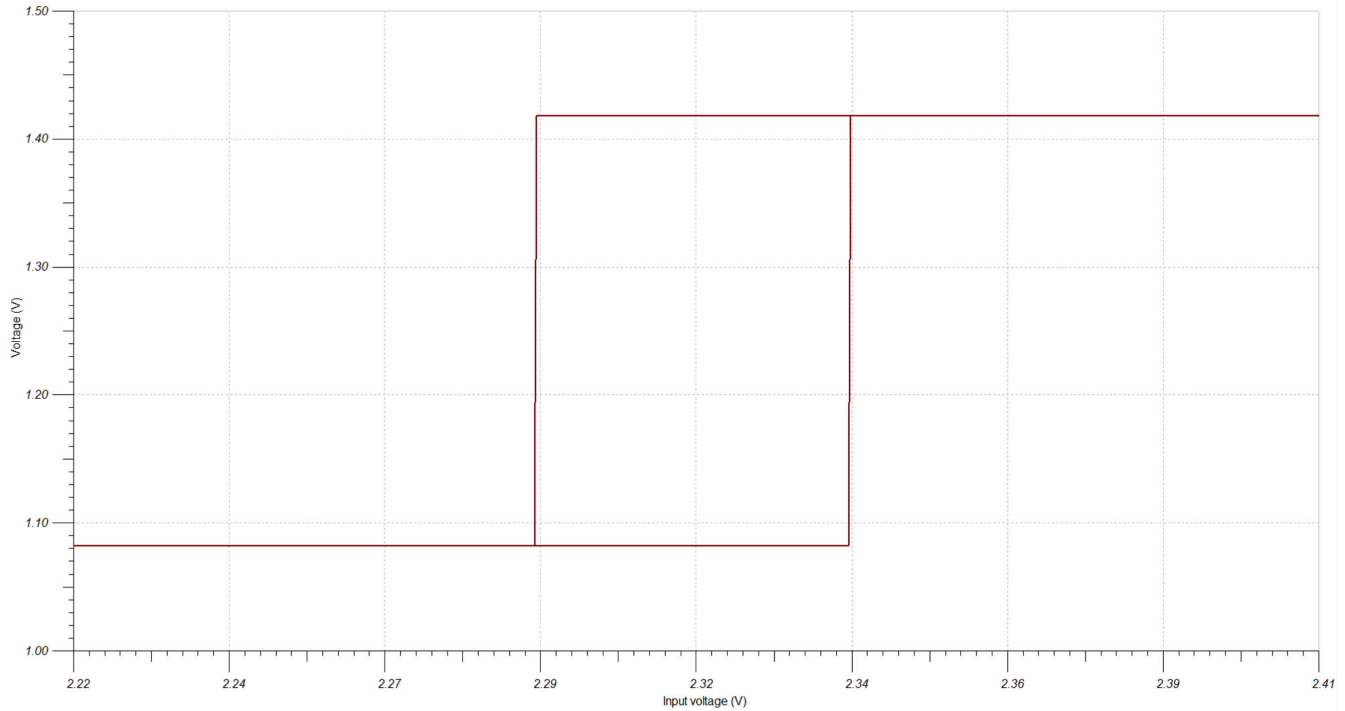

**Figure 7-6. Hysteresis Curve for LVDS Comparator**

### 7.2.2 Optical Receiver

The TLV3604, TLV3605, and TLV3607 can be used in conjunction with a high performance amplifier such as the OPA855 to create an optical receiver as shown in the Figure 7-7. The photo diode is connected to a bias voltage and is being driven with a pulsed laser. The OPA855 takes the current conducting through the diode and translates it into a voltage for a high speed comparator to detect. The TLV3604, TLV3605, and TLV3607 will then output the proper LVDS signal according to the threshold set ( $V_{REF2}$ ).

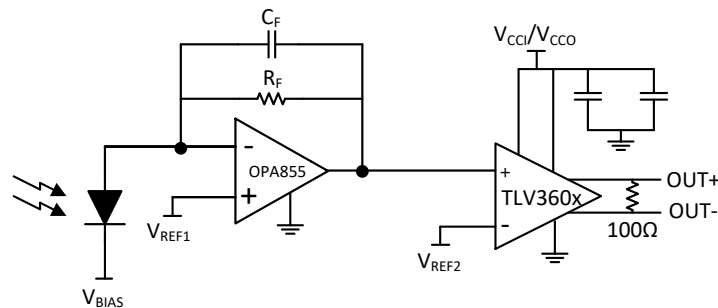

**Figure 7-7. Optical Receiver**

### 7.2.3 Logic Clock Source to LVDS Transceiver

The Figure 7-8 shows a logic clock source being terminated and driven with the TLV3604, TLV3605, and TLV3607 across a CAT6 Cable to receive an equivalent LVDS clock signal at the receiver end.

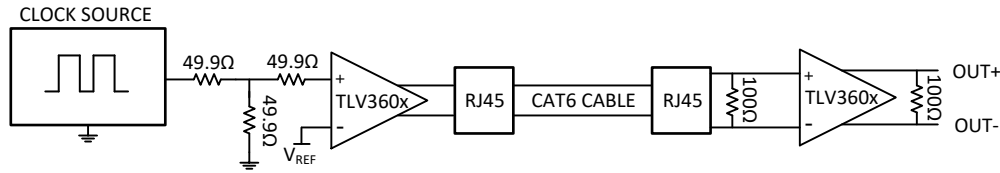

**Figure 7-8. LVDS Clock Transceiver**

### 7.2.4 External Trigger Function for Oscilloscopes

Figure 7-9 is a typical configuration for creating an external trigger on oscilloscopes. The user adjusts the trigger level, and a DAC converts this trigger level to a voltage the TLV360x can use as a reference. The input voltage from an oscilloscope channel is then compared to the trigger reference voltage, and the TLV3604, TLV3605, and TLV3607 sends an LVDS signal to a downstream FPGA to begin a capture.

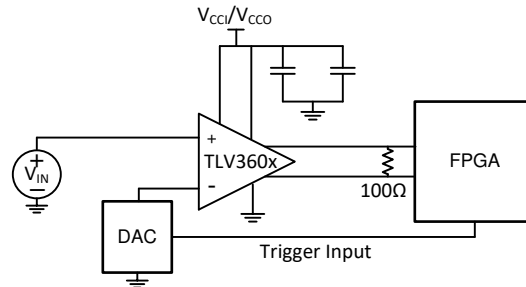

**Figure 7-9. External Trigger Function**

## 7.3 Power Supply Recommendations

The TLV3604, TLV3605, and TLV3607 are recommended for operation from 2.4V to 5.5V. One benefit of the TLV3605 and TLV3607 is that the comparator has separate input and output supply pins (VCCI and VCCO). This provides a system designer the flexibility of powering the input stage with a higher supply voltage such as 5V to maximize the dynamic range of the input while powering the output stage with a 2.5V supply to save power. Regardless of the VCCO supply voltage, the control pins such as LEB and SHDNB are 1.8V logic compliant.

## 7.4 Layout

### 7.4.1 Layout Guidelines

Comparators are very sensitive to input noise. For best results, adhere to the following layout guidelines.

1. Use a printed-circuit-board (PCB) with a good, unbroken, low-inductance ground plane. Proper grounding (use of a ground plane) helps maintain specified device performance and input/output trace impedances.
2. To minimize supply noise, place a decoupling capacitor (0.1- $\mu$ F ceramic, surface-mount capacitor) directly between VCCI/VCCO and VEE.
3. On the inputs and outputs, utilize matched trace lengths to minimize timing skew. Also, minimize trace lengths and maximize ground pour spacings around the input and output traces to limit parasitic capacitance.
4. Solder the device directly to the PCB rather than using a socket.
5. For slow-moving input signals, take care to prevent parasitic feedback. A small capacitor (1000pF or less) placed between the inputs can help eliminate oscillations in the transition region. This capacitor causes minimal degradation to propagation delay when source impedance is low.
6. Use a 100 $\Omega$  termination resistor across the device's LVDS outputs.
7. Use higher performance substrate materials such as Rogers or High-Speed FR4.
8. PCB signal layers from the TLV3604EVM are shown for reference.

### 7.4.2 Layout Example

Figure 10-1 shows the 4 layer PCB signal routing for the TLV3604EVM as an example for how layout on this device can be done.

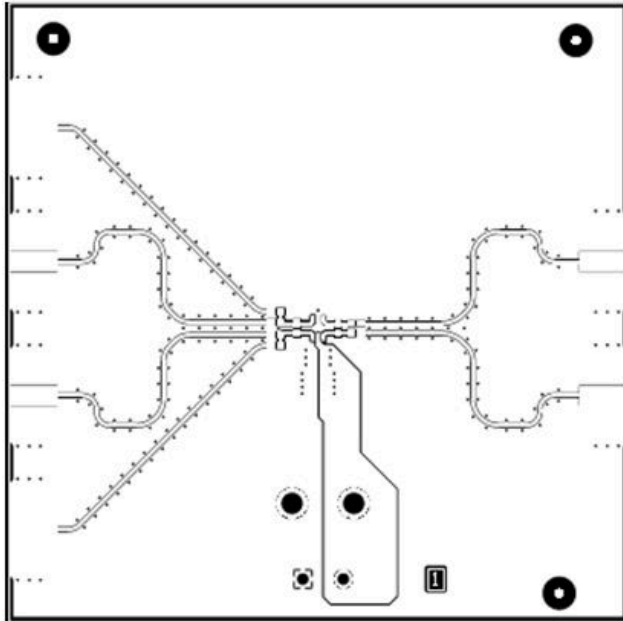

Top Layer

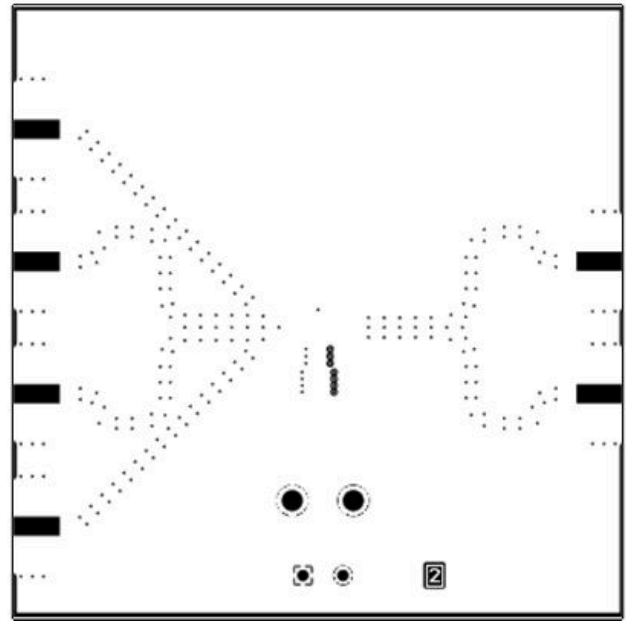

GND-1 Layer

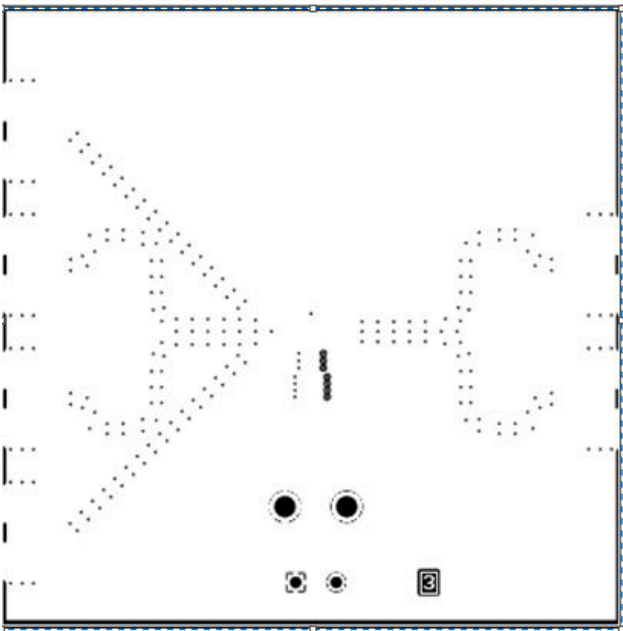

GND-2 Layer

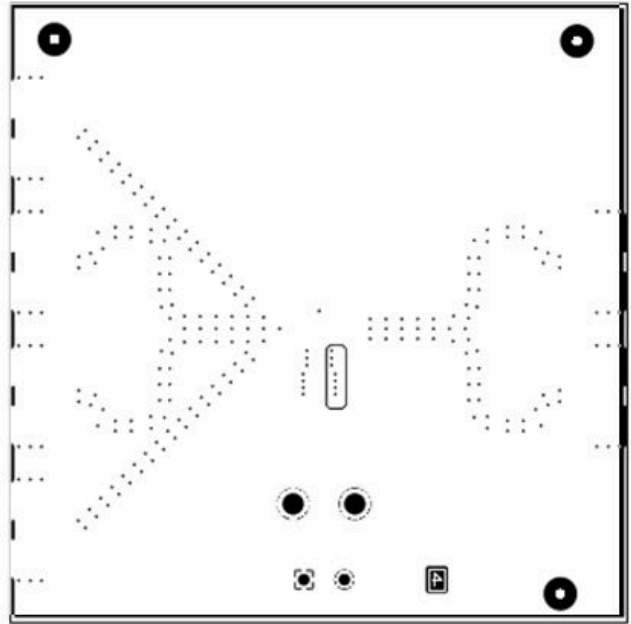

Bottom Layer

Figure 7-10. TLV3604EVM Layout Example

## 8 Device and Documentation Support

### 8.1 Device Support

#### 8.1.1 Development Support

[LIDAR Pulsed Time of Flight Reference Design](#)

### 8.2 Receiving Notification of Documentation Updates

To receive notification of documentation updates, navigate to the device product folder on [ti.com](https://www.ti.com). Click on *Notifications* to register and receive a weekly digest of any product information that has changed. For change details, review the revision history included in any revised document.

### 8.3 Support Resources

[TI E2E™ support forums](#) are an engineer's go-to source for fast, verified answers and design help — straight from the experts. Search existing answers or ask your own question to get the quick design help you need.

Linked content is provided "AS IS" by the respective contributors. They do not constitute TI specifications and do not necessarily reflect TI's views; see TI's [Terms of Use](#).

### 8.4 Trademarks

TI E2E™ is a trademark of Texas Instruments.  
All trademarks are the property of their respective owners.

### 8.5 Electrostatic Discharge Caution



This integrated circuit can be damaged by ESD. Texas Instruments recommends that all integrated circuits be handled with appropriate precautions. Failure to observe proper handling and installation procedures can cause damage.

ESD damage can range from subtle performance degradation to complete device failure. Precision integrated circuits may be more susceptible to damage because very small parametric changes could cause the device not to meet its published specifications.

### 8.6 Glossary

[TI Glossary](#) This glossary lists and explains terms, acronyms, and definitions.

## 9 Revision History

NOTE: Page numbers for previous revisions may differ from page numbers in the current version.

| <b>Changes from Revision E (July 2023) to Revision F (June 2024)</b> | <b>Page</b>        |
|----------------------------------------------------------------------|--------------------|
| • Improved TLV3607 propagation delay to 800ps.....                   | <a href="#">1</a>  |
| • Updated Typical Application section.....                           | <a href="#">16</a> |

| <b>Changes from Revision D (June 2021) to Revision E (July 2023)</b> | <b>Page</b>       |
|----------------------------------------------------------------------|-------------------|
| • Added the dual channel TLV3607 throughout data sheet.....          | <a href="#">1</a> |

| <b>Changes from Revision C (April 2021) to Revision D (June 2021)</b> | <b>Page</b>        |
|-----------------------------------------------------------------------|--------------------|
| • Update Hysteresis Curve.....                                        | <a href="#">15</a> |

---

**Changes from Revision B (December 2020) to Revision C (April 2021)** **Page**

- Updated Typical Performance Curves..... [9](#)
  - Updated Latch Functionality..... [14](#)
- 

---

**Changes from Revision A (August 2020) to Revision B (December 2020)** **Page**

- APL to RTM release..... [1](#)
- 

## 10 Mechanical, Packaging, and Orderable Information

The following pages include mechanical, packaging, and orderable information. This information is the most current data available for the designated devices. This data is subject to change without notice and revision of this document. For browser-based versions of this data sheet, refer to the left-hand navigation.

**PACKAGING INFORMATION**

| Orderable Device | Status<br>(1) | Package Type | Package Drawing | Pins | Package Qty | Eco Plan<br>(2) | Lead finish/<br>Ball material<br>(6) | MSL Peak Temp<br>(3) | Op Temp (°C) | Device Marking<br>(4/5) | Samples                 |
|------------------|---------------|--------------|-----------------|------|-------------|-----------------|--------------------------------------|----------------------|--------------|-------------------------|-------------------------|
| TLV3604DCKR      | ACTIVE        | SC70         | DCK             | 6    | 3000        | RoHS & Green    | NIPDAU                               | Level-1-260C-UNLIM   | -40 to 125   | 1HF                     | <a href="#">Samples</a> |
| TLV3604DCKT      | ACTIVE        | SC70         | DCK             | 6    | 250         | RoHS & Green    | NIPDAU                               | Level-1-260C-UNLIM   | -40 to 125   | 1HF                     | <a href="#">Samples</a> |
| TLV3605RVKR      | ACTIVE        | WQFN         | RVK             | 12   | 3000        | RoHS & Green    | NIPDAU                               | Level-1-260C-UNLIM   | -40 to 125   | 3605                    | <a href="#">Samples</a> |
| TLV3605RVKT      | ACTIVE        | WQFN         | RVK             | 12   | 250         | RoHS & Green    | NIPDAU                               | Level-1-260C-UNLIM   | -40 to 125   | 3605                    | <a href="#">Samples</a> |
| TLV3607RTER      | ACTIVE        | WQFN         | RTE             | 16   | 5000        | RoHS & Green    | NIPDAU                               | Level-1-260C-UNLIM   | -40 to 125   | TL3607                  | <a href="#">Samples</a> |

(1) The marketing status values are defined as follows:

**ACTIVE:** Product device recommended for new designs.

**LIFEBUY:** TI has announced that the device will be discontinued, and a lifetime-buy period is in effect.

**NRND:** Not recommended for new designs. Device is in production to support existing customers, but TI does not recommend using this part in a new design.

**PREVIEW:** Device has been announced but is not in production. Samples may or may not be available.

**OBSELETE:** TI has discontinued the production of the device.

(2) **RoHS:** TI defines "RoHS" to mean semiconductor products that are compliant with the current EU RoHS requirements for all 10 RoHS substances, including the requirement that RoHS substance do not exceed 0.1% by weight in homogeneous materials. Where designed to be soldered at high temperatures, "RoHS" products are suitable for use in specified lead-free processes. TI may reference these types of products as "Pb-Free".

**RoHS Exempt:** TI defines "RoHS Exempt" to mean products that contain lead but are compliant with EU RoHS pursuant to a specific EU RoHS exemption.

**Green:** TI defines "Green" to mean the content of Chlorine (Cl) and Bromine (Br) based flame retardants meet JS709B low halogen requirements of <=1000ppm threshold. Antimony trioxide based flame retardants must also meet the <=1000ppm threshold requirement.

(3) MSL, Peak Temp. - The Moisture Sensitivity Level rating according to the JEDEC industry standard classifications, and peak solder temperature.

(4) There may be additional marking, which relates to the logo, the lot trace code information, or the environmental category on the device.

(5) Multiple Device Markings will be inside parentheses. Only one Device Marking contained in parentheses and separated by a "~" will appear on a device. If a line is indented then it is a continuation of the previous line and the two combined represent the entire Device Marking for that device.

(6) Lead finish/Ball material - Orderable Devices may have multiple material finish options. Finish options are separated by a vertical ruled line. Lead finish/Ball material values may wrap to two lines if the finish value exceeds the maximum column width.

**Important Information and Disclaimer:** The information provided on this page represents TI's knowledge and belief as of the date that it is provided. TI bases its knowledge and belief on information provided by third parties, and makes no representation or warranty as to the accuracy of such information. Efforts are underway to better integrate information from third parties. TI has taken and continues to take reasonable steps to provide representative and accurate information but may not have conducted destructive testing or chemical analysis on incoming materials and chemicals. TI and TI suppliers consider certain information to be proprietary, and thus CAS numbers and other limited information may not be available for release.

In no event shall TI's liability arising out of such information exceed the total purchase price of the TI part(s) at issue in this document sold by TI to Customer on an annual basis.



**TAPE AND REEL INFORMATION**

**QUADRANT ASSIGNMENTS FOR PIN 1 ORIENTATION IN TAPE**

\*All dimensions are nominal

| Device      | Package Type | Package Drawing | Pins | SPQ  | Reel Diameter (mm) | Reel Width W1 (mm) | A0 (mm) | B0 (mm) | K0 (mm) | P1 (mm) | W (mm) | Pin1 Quadrant |
|-------------|--------------|-----------------|------|------|--------------------|--------------------|---------|---------|---------|---------|--------|---------------|
| TLV3604DCKR | SC70         | DCK             | 6    | 3000 | 180.0              | 8.4                | 2.47    | 2.3     | 1.25    | 4.0     | 8.0    | Q3            |
| TLV3604DCKT | SC70         | DCK             | 6    | 250  | 180.0              | 8.4                | 2.47    | 2.3     | 1.25    | 4.0     | 8.0    | Q3            |
| TLV3605RVKR | WQFN         | RVK             | 12   | 3000 | 330.0              | 12.4               | 3.3     | 3.3     | 1.1     | 8.0     | 12.0   | Q2            |
| TLV3605RVKT | WQFN         | RVK             | 12   | 250  | 180.0              | 12.4               | 3.3     | 3.3     | 1.1     | 8.0     | 12.0   | Q2            |
| TLV3607RTER | WQFN         | RTE             | 16   | 5000 | 330.0              | 12.4               | 3.3     | 3.3     | 1.1     | 8.0     | 12.0   | Q2            |

## TAPE AND REEL BOX DIMENSIONS



\*All dimensions are nominal

| Device      | Package Type | Package Drawing | Pins | SPQ  | Length (mm) | Width (mm) | Height (mm) |
|-------------|--------------|-----------------|------|------|-------------|------------|-------------|
| TLV3604DCKR | SC70         | DCK             | 6    | 3000 | 183.0       | 183.0      | 20.0        |
| TLV3604DCKT | SC70         | DCK             | 6    | 250  | 183.0       | 183.0      | 20.0        |
| TLV3605RVKR | WQFN         | RVK             | 12   | 3000 | 367.0       | 367.0      | 35.0        |
| TLV3605RVKT | WQFN         | RVK             | 12   | 250  | 210.0       | 185.0      | 35.0        |
| TLV3607RTER | WQFN         | RTE             | 16   | 5000 | 367.0       | 367.0      | 35.0        |

# DCK0006A



## PACKAGE OUTLINE

SOT - 1.1 max height

SMALL OUTLINE TRANSISTOR

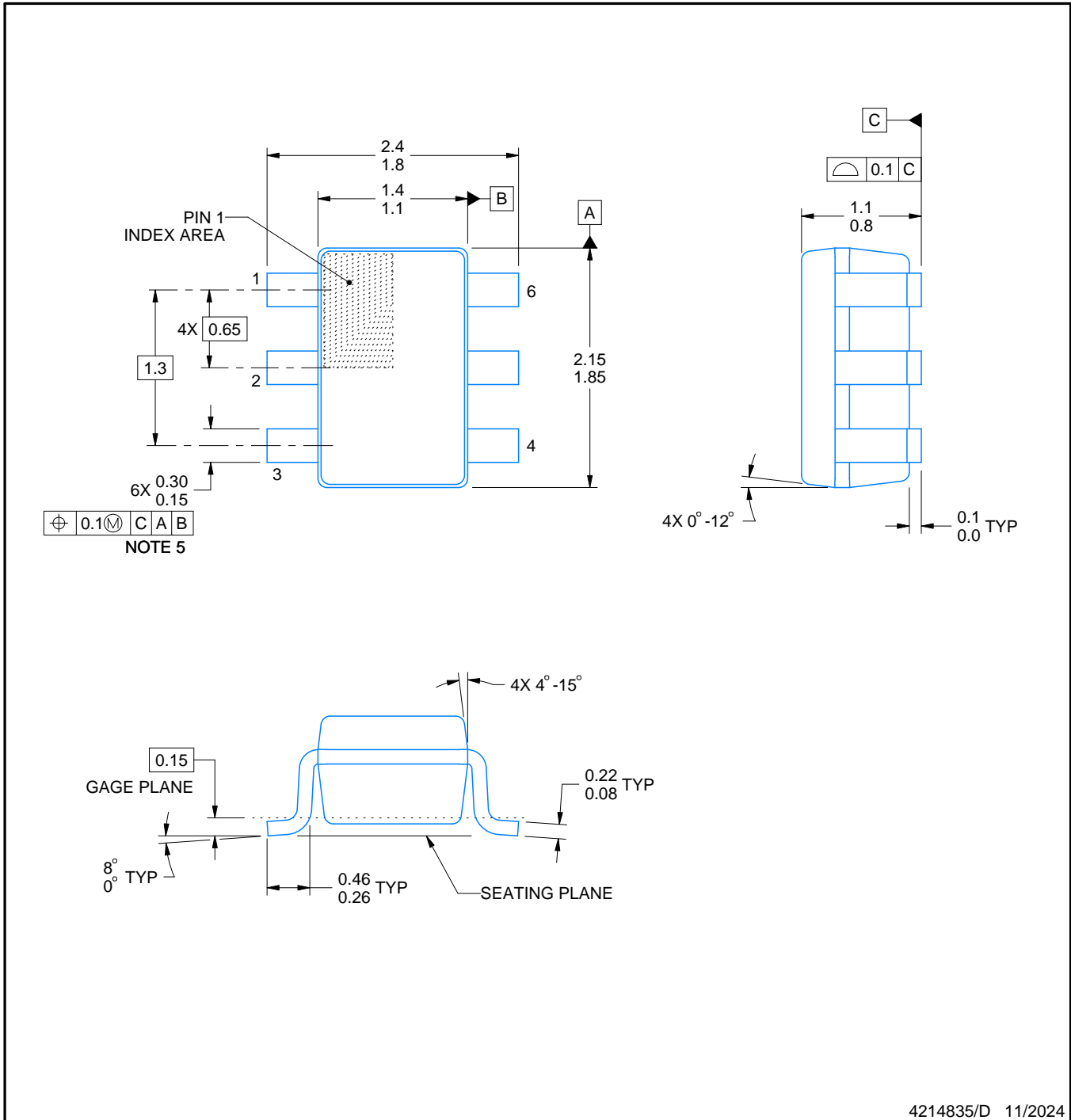

4214835/D 11/2024

### NOTES:

1. All linear dimensions are in millimeters. Any dimensions in parenthesis are for reference only. Dimensioning and tolerancing per ASME Y14.5M.
2. This drawing is subject to change without notice.
3. Body dimensions do not include mold flash or protrusion. Mold flash and protrusion shall not exceed 0.15 per side.
4. Falls within JEDEC MO-203 variation AB.

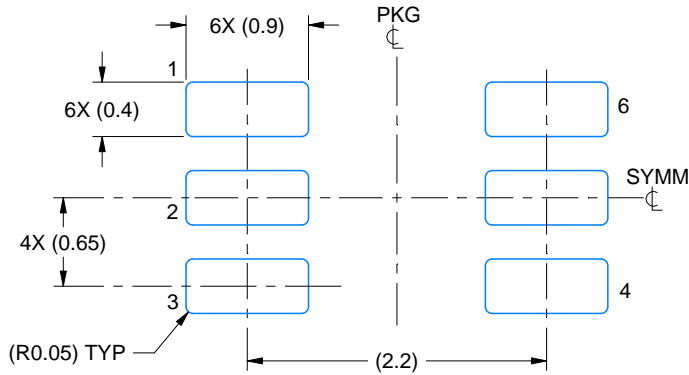

LAND PATTERN EXAMPLE  
EXPOSED METAL SHOWN  
SCALE:18X

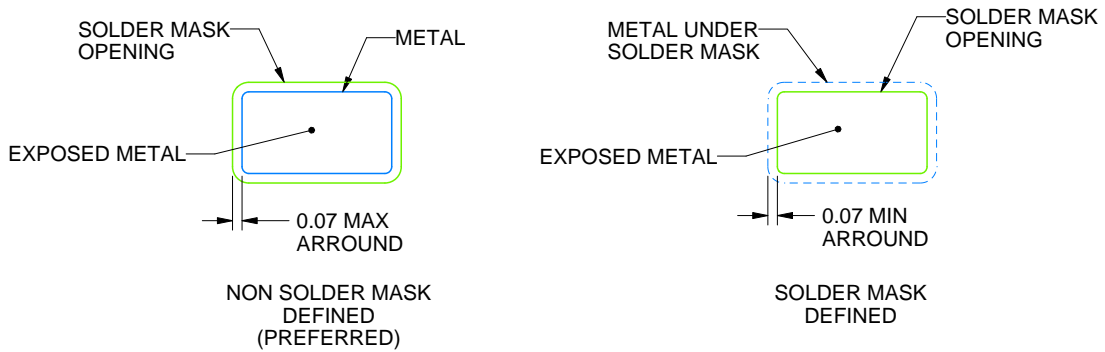

SOLDER MASK DETAILS

4214835/D 11/2024

NOTES: (continued)

- 5. Publication IPC-7351 may have alternate designs.
- 6. Solder mask tolerances between and around signal pads can vary based on board fabrication site.

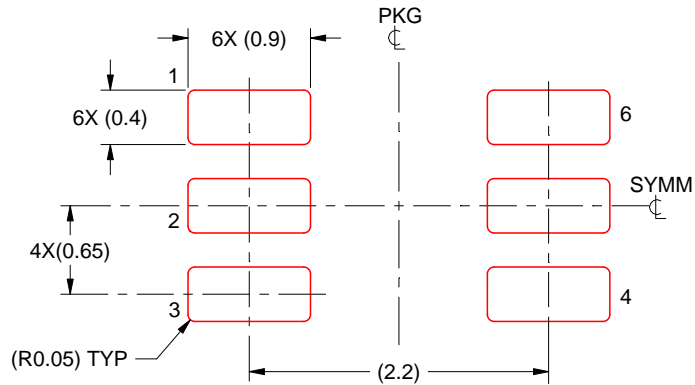

SOLDER PASTE EXAMPLE  
BASED ON 0.125 THICK STENCIL  
SCALE:18X

4214835/D 11/2024

NOTES: (continued)

7. Laser cutting apertures with trapezoidal walls and rounded corners may offer better paste release. IPC-7525 may have alternate design recommendations.
8. Board assembly site may have different recommendations for stencil design.

## GENERIC PACKAGE VIEW

**RTE 16**

**WQFN - 0.8 mm max height**

3 x 3, 0.5 mm pitch

PLASTIC QUAD FLATPACK - NO LEAD

This image is a representation of the package family, actual package may vary.  
Refer to the product data sheet for package details.



4225944/A



| SIDE WALL METAL THICKNESS DIM A |          |
|---------------------------------|----------|
| OPTION 1                        | OPTION 2 |
| 0.1                             | 0.2      |

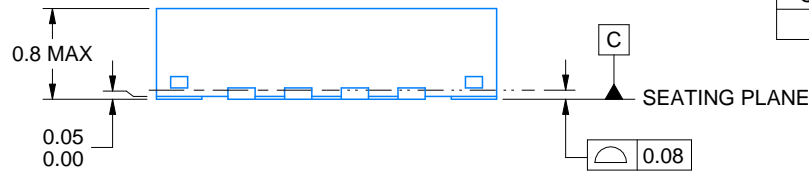

4219117/B 04/2022

NOTES:

1. All linear dimensions are in millimeters. Any dimensions in parenthesis are for reference only. Dimensioning and tolerancing per ASME Y14.5M.
2. This drawing is subject to change without notice.
3. The package thermal pad must be soldered to the printed circuit board for thermal and mechanical performance.

# EXAMPLE BOARD LAYOUT

RTE0016C

WQFN - 0.8 mm max height

PLASTIC QUAD FLATPACK - NO LEAD

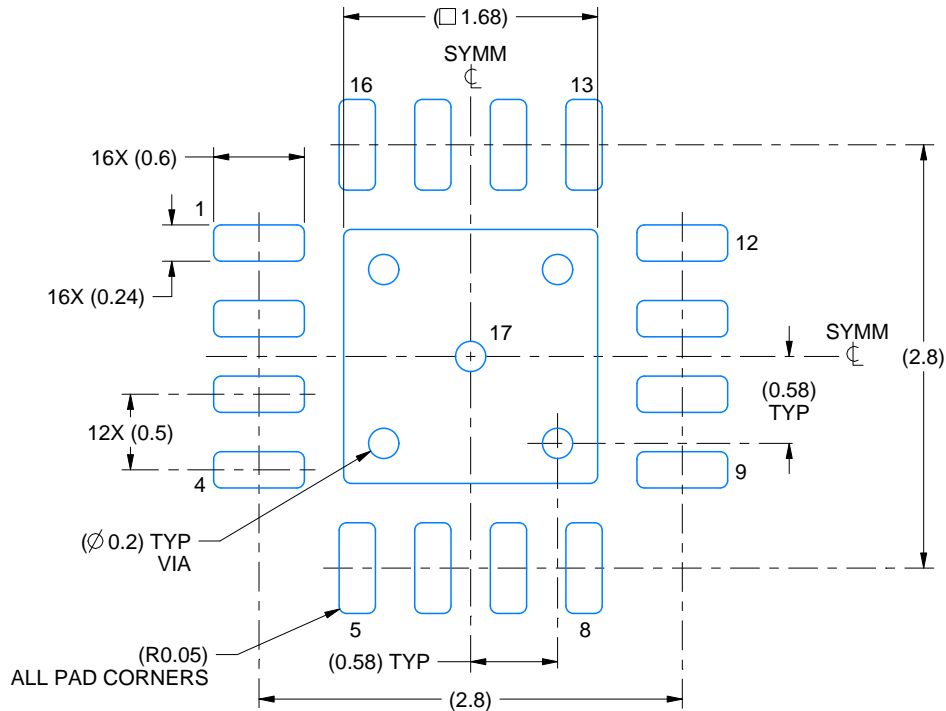

LAND PATTERN EXAMPLE  
EXPOSED METAL SHOWN  
SCALE:20X



SOLDER MASK DETAILS

4219117/B 04/2022

NOTES: (continued)

- This package is designed to be soldered to a thermal pad on the board. For more information, see Texas Instruments literature number SLUA271 ([www.ti.com/lit/slua271](http://www.ti.com/lit/slua271)).
- Vias are optional depending on application, refer to device data sheet. If any vias are implemented, refer to their locations shown on this view. It is recommended that vias under paste be filled, plugged or tented.



# EXAMPLE STENCIL DESIGN

RTE0016C

WQFN - 0.8 mm max height

PLASTIC QUAD FLATPACK - NO LEAD



**SOLDER PASTE EXAMPLE**  
BASED ON 0.125 mm THICK STENCIL

EXPOSED PAD 17:  
85% PRINTED SOLDER COVERAGE BY AREA UNDER PACKAGE  
SCALE:25X

4219117/B 04/2022

NOTES: (continued)

6. Laser cutting apertures with trapezoidal walls and rounded corners may offer better paste release. IPC-7525 may have alternate design recommendations.

RVK (S-PWQFN-N12)

PLASTIC QUAD FLATPACK NO-LEAD

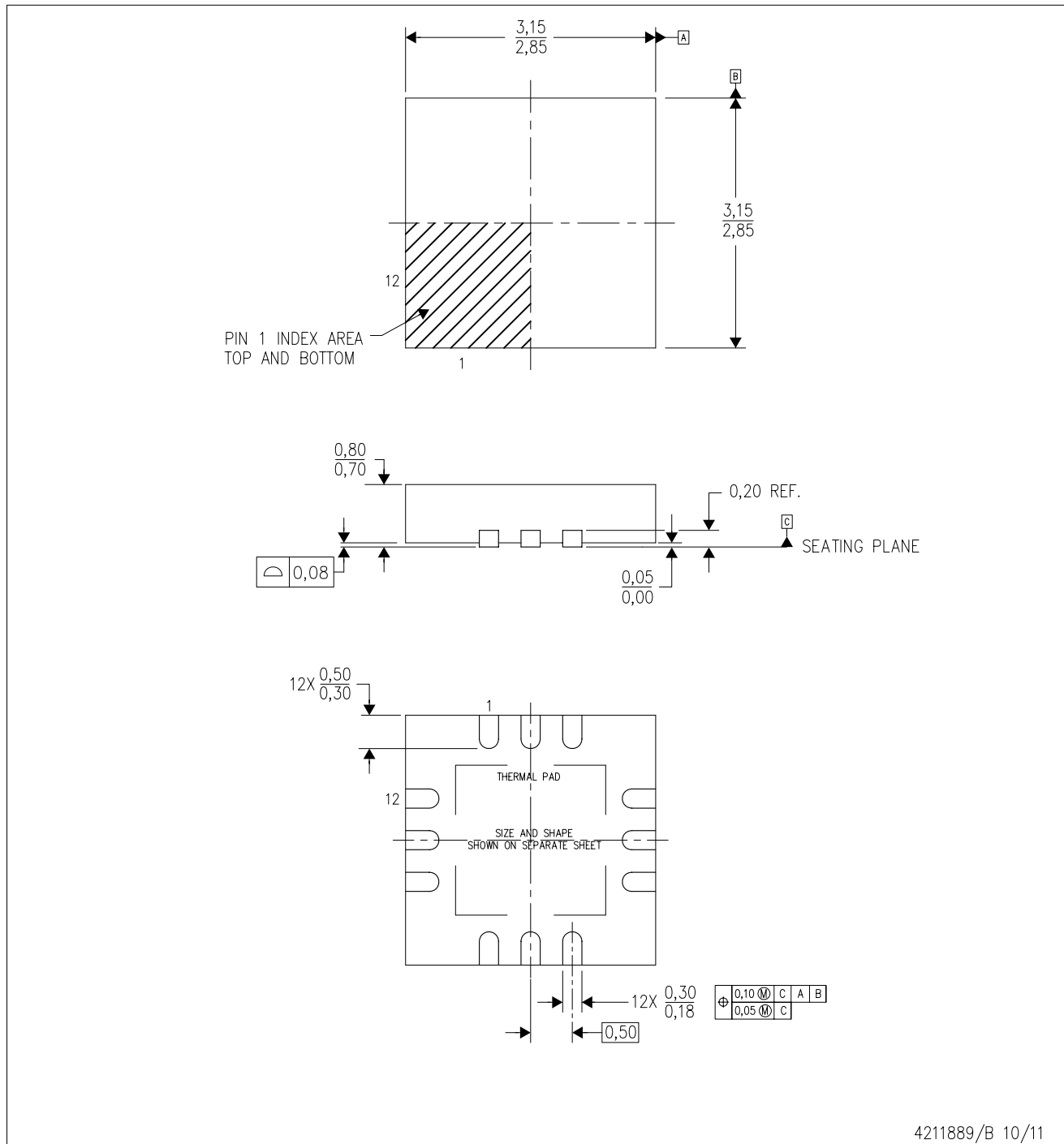

4211889/B 10/11

- NOTES:
- All linear dimensions are in millimeters. Dimensioning and tolerancing per ASME Y14.5M-1994.
  - This drawing is subject to change without notice.
  - Quad Flatpack, No-leads (QFN) package configuration.
  - The package thermal pad must be soldered to the board for thermal and mechanical performance.
  - See the additional figure in the Product Data Sheet for details regarding the exposed thermal pad features and dimensions.
  - Falls within JEDEC MO-220.

## IMPORTANT NOTICE AND DISCLAIMER

TI PROVIDES TECHNICAL AND RELIABILITY DATA (INCLUDING DATA SHEETS), DESIGN RESOURCES (INCLUDING REFERENCE DESIGNS), APPLICATION OR OTHER DESIGN ADVICE, WEB TOOLS, SAFETY INFORMATION, AND OTHER RESOURCES "AS IS" AND WITH ALL FAULTS, AND DISCLAIMS ALL WARRANTIES, EXPRESS AND IMPLIED, INCLUDING WITHOUT LIMITATION ANY IMPLIED WARRANTIES OF MERCHANTABILITY, FITNESS FOR A PARTICULAR PURPOSE OR NON-INFRINGEMENT OF THIRD PARTY INTELLECTUAL PROPERTY RIGHTS.

These resources are intended for skilled developers designing with TI products. You are solely responsible for (1) selecting the appropriate TI products for your application, (2) designing, validating and testing your application, and (3) ensuring your application meets applicable standards, and any other safety, security, regulatory or other requirements.

These resources are subject to change without notice. TI grants you permission to use these resources only for development of an application that uses the TI products described in the resource. Other reproduction and display of these resources is prohibited. No license is granted to any other TI intellectual property right or to any third party intellectual property right. TI disclaims responsibility for, and you will fully indemnify TI and its representatives against, any claims, damages, costs, losses, and liabilities arising out of your use of these resources.

TI's products are provided subject to [TI's Terms of Sale](#) or other applicable terms available either on [ti.com](https://www.ti.com) or provided in conjunction with such TI products. TI's provision of these resources does not expand or otherwise alter TI's applicable warranties or warranty disclaimers for TI products.

TI objects to and rejects any additional or different terms you may have proposed.

Mailing Address: Texas Instruments, Post Office Box 655303, Dallas, Texas 75265

Copyright © 2025, Texas Instruments Incorporated