

Advanced LinCMOS™ RAIL-TO-RAIL OUTPUT WIDE-INPUT-VOLTAGE OPERATIONAL AMPLIFIERS

FEATURES

- Qualified for Automotive Applications
- ESD Protection Exceeds 2000 V Per MIL-STD-883, Method 3015; Exceeds 200 V Using Machine Model (C = 200 pF, R = 0)
- Output Swing Includes Both Supply Rails
- Extended Common-Mode Input Voltage Range: 0 V to 4.25 V (Min) at 5-V Single Supply
- No Phase Inversion
- Low Noise: 16 nV/ $\sqrt{\text{Hz}}$ Typ at $f = 1 \text{ kHz}$
- Low Input Offset Voltage: 950 μV Max at $T_A = 25^\circ\text{C}$ (TLV244xA)
- Low Input Bias Current: 1 pA (Typ)
- 600- Ω Output Drive
- High-Gain Bandwidth: 1.8 MHz (Typ)
- Low Supply Current: 750 μA Per Channel (Typ)
- Macromodel Included

DESCRIPTION

The TLV244x and TLV244xA are low-voltage operational amplifiers from Texas Instruments. The common-mode input voltage range of these devices has been extended over typical standard CMOS amplifiers, making them suitable for a wide range of applications. In addition, these devices do not phase invert when the common-mode input is driven to the supply rails. This satisfies most design requirements without paying a premium for rail-to-rail input performance. They also exhibit rail-to-rail output performance for increased dynamic range in single- or split-supply applications. This family is fully characterized at 3-V and 5-V supplies and is optimized for low-voltage operation. Both devices offer comparable ac performance while having lower noise, input offset voltage, and power dissipation than existing CMOS operational amplifiers. The TLV244x has increased output drive over previous rail-to-rail operational amplifiers and can drive 600- Ω loads for telecommunications applications.

The other members in the TLV244x family are the low-power, TLV243x, and micro-power, TLV2422, versions.

The TLV244x, exhibiting high input impedance and low noise, is excellent for small-signal conditioning for high-impedance sources, such as piezoelectric transducers. Because of the micropower dissipation levels and low-voltage operation, these devices work well in hand-held monitoring and remote-sensing applications. In addition, the rail-to-rail output feature with single- or split-supplies makes this family a great choice when interfacing with analog-to-digital converters (ADCs). For precision applications, the TLV244xA is available with a maximum input offset voltage of 950 μV .

If the design requires single operational amplifiers, see the TI TLV2211/21/31. This is a family of rail-to-rail output operational amplifiers in the SOT-23 package. Their small size and low power consumption make them ideal for high-density battery-powered equipment.

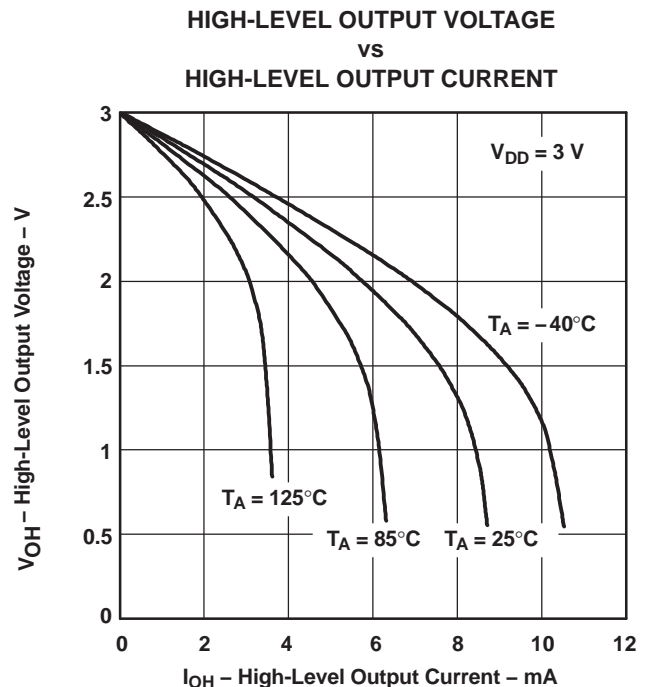

Figure 1.



Please be aware that an important notice concerning availability, standard warranty, and use in critical applications of Texas Instruments semiconductor products and disclaimers thereto appears at the end of this data sheet.

Advanced LinCMOS is a trademark of Texas Instruments.
P Spice, Parts are trademarks of MicroSim.

ORDERING INFORMATION⁽¹⁾

T _A	V _{IO} max AT 25 = C	PACKAGE ⁽²⁾			ORDERABLE PART NUMBER	TOP-SIDE MARKING
-40°C to 125°C	950 μV	Dual	SOIC – D	Reel of 2500	TLV2442AQDRQ1	2442AQ
			TSSOP – PW	Reel of 2000	TLV2442AQPWRQ1	2442AQ
	2.5 mV	Dual	MSOP – DGK	Reel of 2500	TLV2442QDGKRQ1	OBR
			SOIC – D	Reel of 2500	TLV2442QDRQ1	2442Q1
			TSSOP – PW	Reel of 2000	TLV2442QPWRQ1	2442Q1
	950 μV	Quad	TSSOP – PW	Reel of 2000	TLV2444AQPWRQ1	2444AQ

- (1) For the most current package and ordering information, see the Package Option Addendum at the end of this document, or see the TI web site at www.ti.com.
- (2) Package drawings, thermal data, and symbolization are available at www.ti.com/packaging.

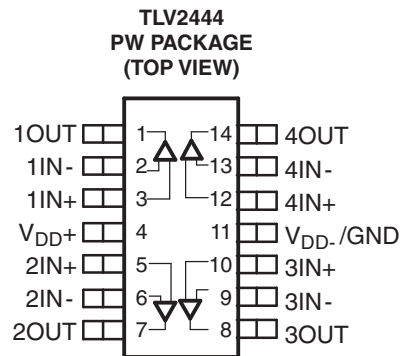
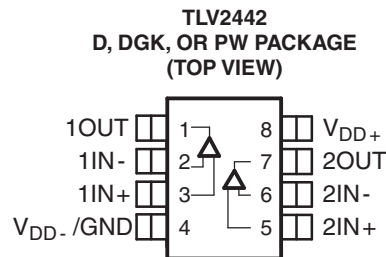

EQUIVALENT SCHEMATIC (EACH AMPLIFIER)

COMPONENT COUNT	
Transistors	69
Diodes	5
Resistors	26
Capacitors	6

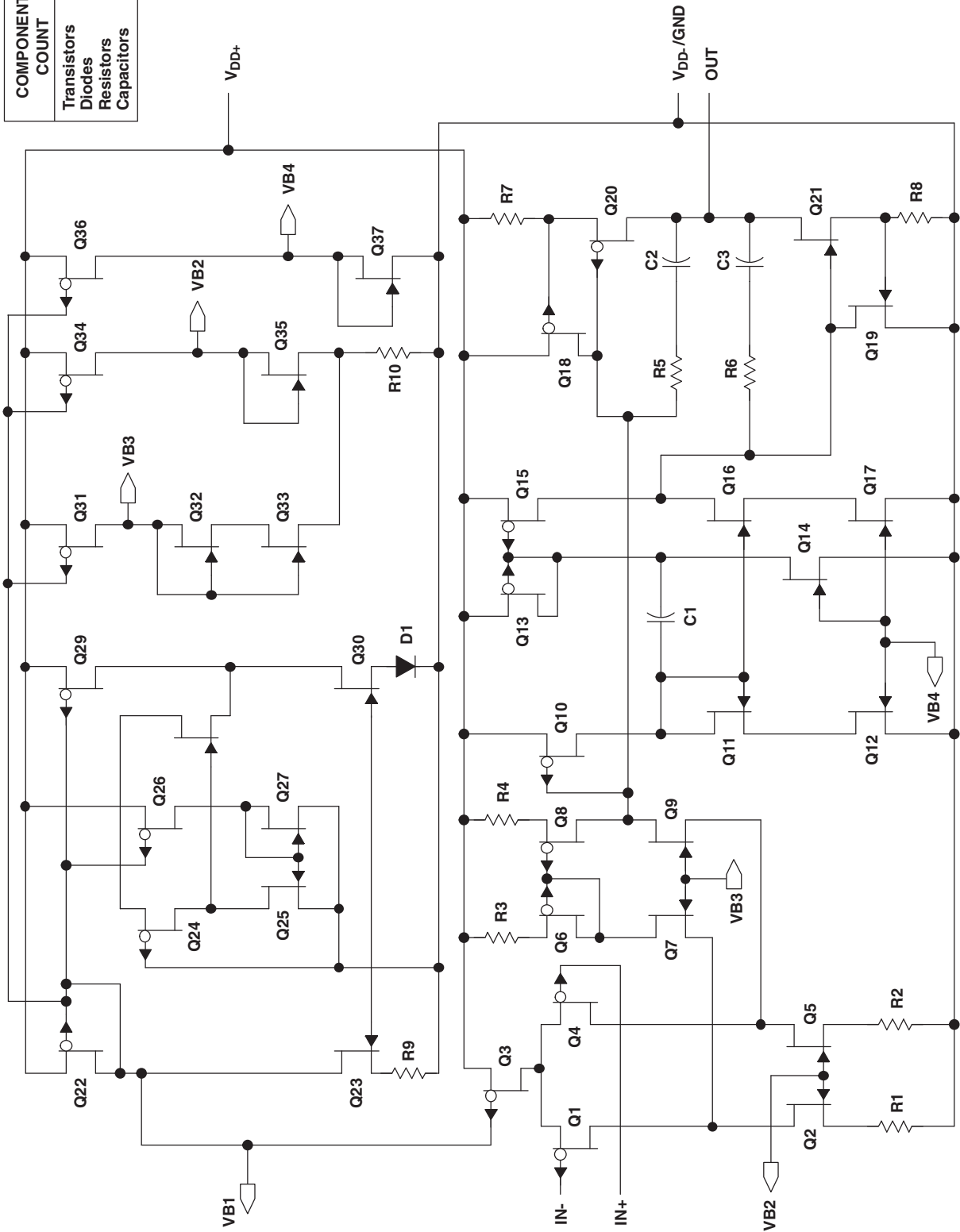

ABSOLUTE MAXIMUM RATINGS⁽¹⁾

over operating free-air temperature range (unless otherwise noted)

V _{DD}	Supply voltage ⁽²⁾	12 V
V _{ID}	Differential input voltage ⁽³⁾	±V _{DD}
V _I	Input voltage (any input) ⁽²⁾	−0.3 V to V _{DD}
I _I	Input current (any input)	±5 mA
I _O	Output current	±50 mA
	Total current into V _{DD+}	±50 mA
	Total current out of V _{DD−}	±50 mA
	Duration of short-circuit current at (or below) 25 = C ⁽⁴⁾	Unlimited
	Continuous total dissipation	See Dissipation Rating Table
T _A	Operating free-air temperature range	−40°C to 125°C
T _{stg}	Storage temperature range	−65°C to 150°C
	Lead temperature 1,6 mm (1/16 inch) from case for 10 seconds	260°C

- (1) Stresses beyond those listed under *absolute maximum ratings* may cause permanent damage to the device. These are stress ratings only, and functional operation of the device at these or any other conditions beyond those indicated under *recommended operating conditions* is not implied. Exposure to absolute-maximum-rated conditions for extended periods may affect device reliability.
- (2) All voltage values, except differential voltages, are with respect to the midpoint between V_{DD+} and V_{DD−}.
- (3) Differential voltages are at IN+ with respect to IN−. Excessive current will flow if input is brought below V_{DD−} − 0.3 V.
- (4) The output may be shorted to either supply. Temperature and/or supply voltages must be limited to ensure that the maximum dissipation rating is not exceeded.

DISSIPATION RATINGS

PACKAGE	T _A ≤ 25°C POWER RATING	DERATING FACTOR ABOVE T _A = 25°C	T _A = 70°C POWER RATING	T _A = 85°C POWER RATING	T _A = 125°C POWER RATING
D (8 pin)	725 mW	5.8 mW/°C	464 mW	377 mW	145 mW
DGK (8 pin)	606 mW	4.847 mW/°C	388 mW	315 mW	121 mW
PW (8 pin)	525 mW	4.2 mW/°C	336 mW	273 mW	105 mW
PW (14 pin)	720 mW	5.6 mW/°C	634 mW	547 mW	317 mW

RECOMMENDED OPERATING CONDITIONS

		MIN	MAX	UNIT
V _{DD}	Supply voltage	2.7	10	V
V _I	Input voltage	V _{DD−}	V _{DD+} − 1	V
V _{IC}	Common-mode input voltage	V _{DD−}	V _{DD+} − 1	V
T _A	Operating free-air temperature	−40	125	°C

ELECTRICAL CHARACTERISTICS

$V_{DD} = 3\text{ V}$, at specified free-air temperature (unless otherwise noted)

PARAMETER	TEST CONDITIONS	T_A ⁽¹⁾	MIN	TYP	MAX	UNIT
V_{IO} Input offset voltage	$V_{IC} = 1.5\text{ V}$, $V_O = 1.5\text{ V}$, $R_S = 50\ \Omega$	TLV244x	25°C	300	2000	μV
			Full range		2500	
		TLV244xA	25°C	300	950	
			Full range		1600	
α_{VIO} Temperature coefficient of input offset voltage	$V_{IC} = 1.5\text{ V}$, $V_O = 1.5\text{ V}$, $R_S = 50\ \Omega$	25°C to 85°C		2		$\mu\text{V}/^\circ\text{C}$
Input offset voltage long-term drift ⁽²⁾	$V_{IC} = 1.5\text{ V}$, $V_O = 1.5\text{ V}$, $R_S = 50\ \Omega$	25°C		0.002		$\mu\text{V}/\text{mo}$
I_{IO} Input offset current	$V_{IC} = 1.5\text{ V}$, $V_O = 1.5\text{ V}$, $R_S = 50\ \Omega$	25°C		0.5		pA
		Full range			150	
I_{IB} Input bias current	$V_{IC} = 1.5\text{ V}$, $V_O = 1.5\text{ V}$, $R_S = 50\ \Omega$	25°C		1		pA
		Full range			260	
V_{ICR} Common-mode input voltage range	$ V_{IO} \leq 8\text{ mV}$, $R_S = 50\ \Omega$	25°C	0 to 2.25	-0.25 to 2.5		V
		Full range	0.2 to 2			
V_{OH} High-level output voltage	$I_O = -100\ \mu\text{A}$ $I_O = -3\text{ mA}$	25°C		2.98		V
		25°C		2.5		
		Full range		2.25		
V_{OL} Low-level output voltage	$V_{IC} = 1.5\text{ V}$	$I_O = 100\ \mu\text{A}$	25°C	0.02		V
		$I_O = 3\text{ mA}$	25°C	0.63		
			Full range			
A_{VD} Large-signal differential voltage amplification	$V_O = 1\text{ V to }2\text{ V}$	$R_L = 600\ \Omega$	25°C	0.7	1	V/mV
			Full range	0.4		
		$R_L = 1\text{ M}\Omega$	25°C		750	
r_{id} Differential input resistance		25°C		1000		$\text{G}\Omega$
r_i Common-mode input resistance		25°C		1000		$\text{G}\Omega$
c_i Common-mode input capacitance	$f = 10\text{ kHz}$	25°C		8		pF
z_o Closed-loop output impedance	$f = 1\text{ MHz}$, $A_V = 10$	25°C		130		Ω
CMRR Common-mode rejection ratio	$V_{IC} = V_{ICR\text{ MIN}}$, $V_O = V_{DD}/2$, $R_S = 50\ \Omega$	25°C	65	75		dB
		Full range	50			
k_{SVR} Supply-voltage rejection ratio ($\Delta V_{DD\pm}/\Delta V_{IO}$)	$V_{DD} = 2.7\text{ V to }8\text{ V}$, $V_{IC} = V_{DD}/2$, No load	25°C	80	95		dB
		Full range	80			
I_{DD} Supply current (per channel)	$V_O = 1.5\text{ V}$, No load	25°C		725	1100	μA
		Full range			1100	

(1) Full range is -40°C to 125°C .

(2) Typical values are based on the input offset voltage shift observed through 168 hours of operating life test at $T_A = 150^\circ\text{C}$ extrapolated to $T_A = 25^\circ\text{C}$ using the Arrhenius equation and assuming an activation energy of 0.96 eV.

OPERATING CHARACTERISTICS

$V_{DD} = 3\text{ V}$, at specified free-air temperature (unless otherwise noted)

PARAMETER		TEST CONDITIONS		$T_A^{(1)}$	MIN	TYP	MAX	UNIT
SR	Slew rate at unity gain	$V_O = 1\text{ V to }2\text{ V}$, $R_L = 600\ \Omega$, $C_L = 100\text{ pF}$		25°C	0.65	1.3		V/ μs
				Full range	0.4			
V_n	Equivalent input noise voltage			25°C	170			nV/ $\sqrt{\text{Hz}}$
					18			
$V_{n(PP)}$	Peak-to-peak equivalent input noise voltage	$f = 0.1\text{ Hz to }1\text{ Hz}$ $f = 0.1\text{ Hz to }10\text{ Hz}$		25°C	2.6			μV
					5.1			
I_n	Equivalent input noise current			25°C	0.6		fA/ $\sqrt{\text{Hz}}$	
THD+N	Total harmonic distortion plus noise	$V_O = 0.5\text{ V to }2.5\text{ V}$, $R_L = 600\ \Omega$, $f = 1\text{ kHz}$		25°C	$A_V = 1$		0.08	%
					$A_V = 10$			
					$A_V = 100$			
	Gain-bandwidth product	$f = 10\text{ kHz}$, $R_L = 600\ \Omega$, $C_L = 100\text{ pF}$		25°C	1.75		MHz	
BOM	Maximum output-swing bandwidth	$V_{O(PP)} = 1\text{ V}$, $R_L = 600\ \Omega$, $A_V = 1$, $C_L = 100\text{ pF}$		25°C	0.9		MHz	
t_s	Settling time	$A_V = -1$, Step = $-2.3\text{ V to }2.3\text{ V}$, $R_L = 600\ \Omega$, $C_L = 100\text{ pF}$		25°C	To 0.1%		1.5	μs
					To 0.01%			
ϕ_m	Phase margin at unity gain	$R_L = 600\ \Omega$, $C_L = 100\text{ pF}$		25°C	65		°	
	Gain margin	$R_L = 600\ \Omega$, $C_L = 100\text{ pF}$		25°C	9		dB	

(1) Full range is -40°C to 125°C .

ELECTRICAL CHARACTERISTICS

 $V_{DD} = 5\text{ V}$, at specified free-air temperature (unless otherwise noted)

PARAMETER	TEST CONDITIONS	T_A ⁽¹⁾	MIN	TYP	MAX	UNIT
V_{IO} Input offset voltage	$V_{DD\pm} = \pm 2.5\text{ V}$, $V_{IC} = 0$, $V_O = 0$, $R_S = 50\ \Omega$	TLV244x	25°C	300	2000	μV
			Full range		2500	
		TLV244xA	25°C	300	950	
			Full range		1600	
α_{VIO} Temperature coefficient of input offset voltage	$V_{DD\pm} = \pm 2.5\text{ V}$, $V_{IC} = 0$, $V_O = 0$, $R_S = 50\ \Omega$	25°C to 85°C		2		$\mu\text{V}/^\circ\text{C}$
Input offset voltage long-term drift ⁽²⁾	$V_{DD\pm} = \pm 2.5\text{ V}$, $V_{IC} = 0$, $V_O = 0$, $R_S = 50\ \Omega$	25°C		0.002		$\mu\text{V}/\text{mo}$
I_{IO} Input offset current	$V_{DD\pm} = \pm 2.5\text{ V}$, $V_{IC} = 0$, $V_O = 0$, $R_S = 50\ \Omega$	25°C		0.5		pA
		Full range			150	
I_{IB} Input bias current	$V_{DD\pm} = \pm 2.5\text{ V}$, $V_{IC} = 0$, $V_O = 0$, $R_S = 50\ \Omega$	25°C		1		pA
		Full range			260	
V_{ICR} Common-mode input voltage range	$ V_{IO} \leq 5\text{ mV}$, $R_S = 50\ \Omega$	25°C	0 to 4.25	-0.25 to 4.5		V
		Full range	0 to 4			
V_{OH} High-level output voltage	$I_{OH} = -100\ \mu\text{A}$ $I_{OH} = -5\text{ mA}$	25°C		4.97		V
		25°C		4	4.35	
		Full range		4		
V_{OL} Low-level output voltage	$V_{IC} = 2.5\text{ V}$	$I_{OL} = 100\ \mu\text{A}$ $I_{OL} = 5\text{ mA}$	25°C		0.01	V
			25°C		0.8	
		Full range			1.25	
A_{VD} Large-signal differential voltage amplification	$V_{IC} = 2.5\text{ V}$, $V_O = 1\text{ V to }4\text{ V}$	$R_L = 600\ \Omega$ ⁽³⁾	25°C	0.9	1.3	V/mV
			Full range		0.5	
		$R_L = 1\ \text{M}\Omega$ ⁽³⁾	25°C		950	
r_{id} Differential input resistance		25°C		1000		$\text{G}\Omega$
r_i Common-mode input resistance		25°C		1000		$\text{G}\Omega$
c_i Common-mode input capacitance	$f = 10\text{ kHz}$	25°C		8		pF
z_o Closed-loop output impedance	$f = 1\text{ MHz}$, $A_V = 10$	25°C		140		Ω
CMRR Common-mode rejection ratio	$V_{IC} = V_{ICR}\text{ MIN}$, $V_O = V_{DD}/2$, $R_S = 50\ \Omega$	25°C	70	75		dB
		Full range	70			
k_{SVR} Supply-voltage rejection ratio ($\Delta V_{DD}/\Delta V_{IO}$)	$V_{DD} = 4.4\text{ V to }8\text{ V}$, $V_{IC} = V_{DD}/2$, No load	25°C	80	95		dB
		Full range	80			
I_{DD} Supply current (per channel)	$V_O = 2.5\text{ V}$, No load	25°C		750	1100	μA
		Full range			1100	

(1) Full range is -40°C to 125°C .

(2) Typical values are based on the input offset voltage shift observed through 168 hours of operating life test at $T_A = 150^\circ\text{C}$ extrapolated to $T_A = 25^\circ\text{C}$ using the Arrhenius equation and assuming an activation energy of 0.96 eV.

(3) Referenced to 2.5 V

OPERATING CHARACTERISTICS

$V_{DD} = 5\text{ V}$, at specified free-air temperature (unless otherwise noted)

PARAMETER		TEST CONDITIONS		$T_A^{(1)}$	MIN	TYP	MAX	UNIT
SR	Slew rate at unity gain	$V_O = 0.5\text{ V to } 2.5\text{ V}$, $R_L = 600\ \Omega^{(2)}$, $C_L = 100\text{ pF}^{(2)}$		25°C	0.75	1.4		V/ μs
				Full range	0.5			
V_n	Equivalent input noise voltage			25°C	130			nV/ $\sqrt{\text{Hz}}$
					16			
$V_{n(PP)}$	Peak-to-peak equivalent input noise voltage	$f = 0.1\text{ Hz to } 1\text{ Hz}$ $f = 0.1\text{ Hz to } 10\text{ Hz}$		25°C	1.8			μV
					3.6			
I_n	Equivalent input noise current			25°C	0.6		fA/ $\sqrt{\text{Hz}}$	
THD+N	Total harmonic distortion plus noise	$V_O = 1.5\text{ V to } 3.5\text{ V}$, $f = 1\text{ kHz}$, $R_L = 600\ \Omega^{(2)}$		25°C	$A_V = 1$			%
					$A_V = 10$			
					$A_V = 100$			
Gain-bandwidth product		$f = 10\text{ kHz}$, $R_L = 600\ \Omega^{(2)}$, $C_L = 100\text{ pF}^{(2)}$		25°C	1.81		MHz	
BOM	Maximum output-swing bandwidth	$V_{O(PP)} = 2\text{ V}$, $A_V = 1$, $R_L = 600\ \Omega^{(2)}$, $C_L = 100\text{ pF}^{(2)}$		25°C	0.5		MHz	
t_s	Settling time	$A_V = -1$, Step = $-0.5\text{ V to } 2.5\text{ V}$, $R_L = 600\ \Omega^{(2)}$, $C_L = 100\text{ pF}^{(2)}$		25°C	To 0.1%			μs
					To 0.01%			
ϕ_m	Phase margin at unity gain	$R_L = 600\ \Omega^{(2)}$, $C_L = 100\text{ pF}^{(2)}$		25°C	68		°	
	Gain margin	$R_L = 600\ \Omega^{(2)}$, $C_L = 100\text{ pF}^{(2)}$		25°C	8		dB	

(1) Full range is -40°C to 125°C .

(2) Referenced to 2.5 V

TYPICAL CHARACTERISTICS

Table of Graphs⁽¹⁾

			FIGURE
V_{IO}	Input offset voltage	Distribution	2, 3
		vs Common-mode input voltage	4, 5
α_{VIO}	Input offset voltage temperature coefficient	Distribution	6, 7
I_B/I_{IO}	Input bias and input offset currents	vs Free-air temperature	8
V_{OH}	High-level output voltage	vs High-level output current	9, 10
V_{OL}	Low-level output voltage	vs Low-level output current	11, 12
$V_{O(PP)}$	Maximum peak-to-peak output voltage	vs Frequency	13
I_{OS}	Short-circuit output current	vs Supply voltage	14
		vs Free-air temperature	15
V_O	Output voltage	vs Differential input voltage	16, 17
A_{VD}	Differential voltage amplification	vs Load resistance	18
	Large-signal differential voltage amplification and phase margin	vs Frequency	19, 20
	Large-signal differential voltage amplification	vs Free-air temperature	21, 22
Z_o	Output impedance	vs Frequency	23, 24
CMRR	Common-mode rejection ratio	vs Frequency	25
		vs Free-air temperature	26
k_{SVR}	Supply-voltage rejection ratio	vs Frequency	27, 28
		vs Free-air temperature	29
I_{DD}	Supply current	vs Supply voltage	30
SR	Slew rate	vs Load capacitance	31
		vs Free-air temperature	32
V_O	Inverting large-signal pulse response		33, 34
	Voltage-follower large-signal pulse response		35, 36
	Inverting small-signal pulse response		37, 38
	Voltage-follower small-signal pulse response		39, 40
V_n	Equivalent input noise voltage	vs Frequency	41, 42
	Noise voltage	Over a 10-second period	43
THD + N	Total harmonic distortion plus noise	vs Frequency	44, 45
		vs Free-air temperature	46
		vs Supply voltage	47
ϕ_m	Phase margin	vs Frequency	19, 20
		vs Load capacitance	48
	Gain margin	vs Load capacitance	49
B_1	Unity-gain bandwidth	vs Load capacitance	50

(1) For all graphs where $V_{DD} = 5\text{ V}$, all loads are referenced to 2.5 V.

**DISTRIBUTION OF TLV2442
INPUT OFFSET VOLTAGE**

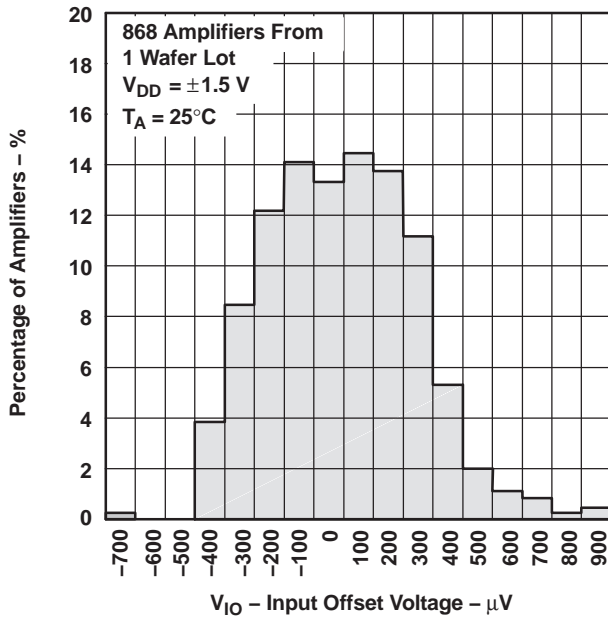

Figure 2.

**DISTRIBUTION OF TLV2442
INPUT OFFSET VOLTAGE**

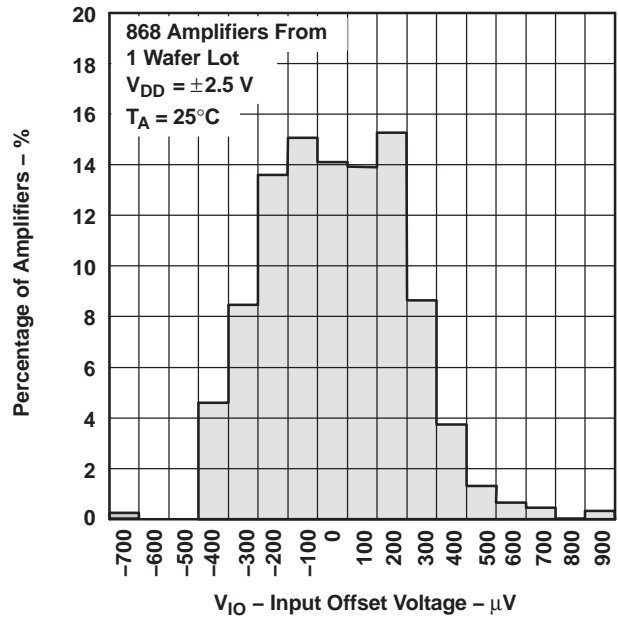

Figure 3.

**INPUT OFFSET VOLTAGE
vs
COMMON-MODE INPUT VOLTAGE**

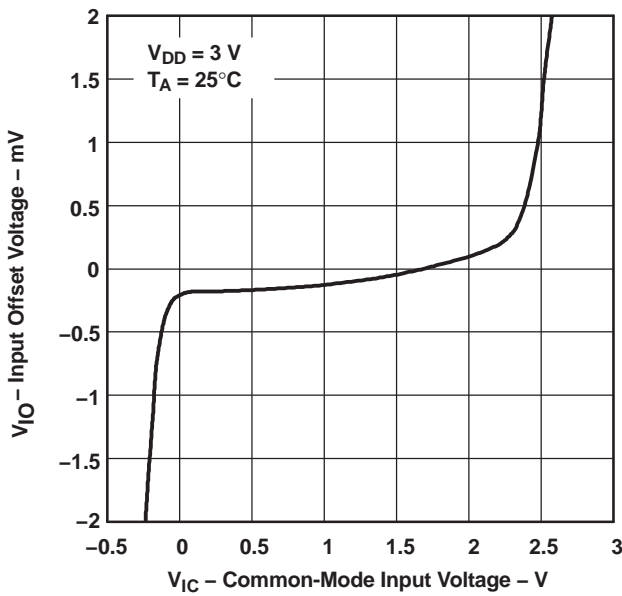

Figure 4.

**INPUT OFFSET VOLTAGE
vs
COMMON-MODE INPUT VOLTAGE**

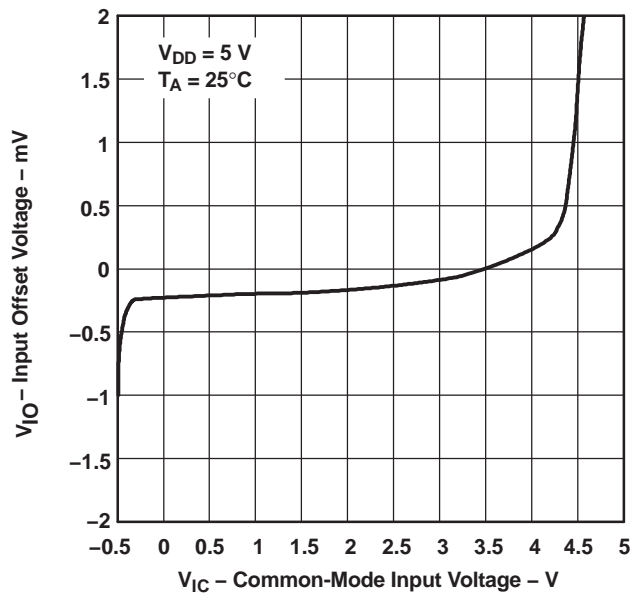

Figure 5.

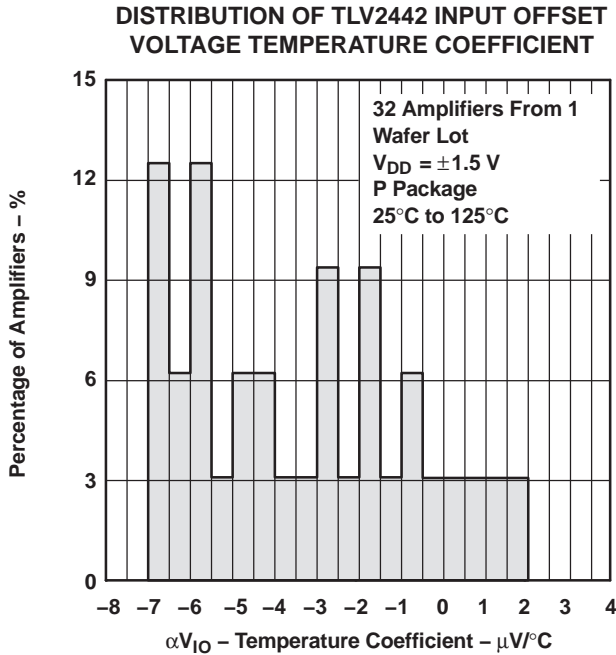

Figure 6.

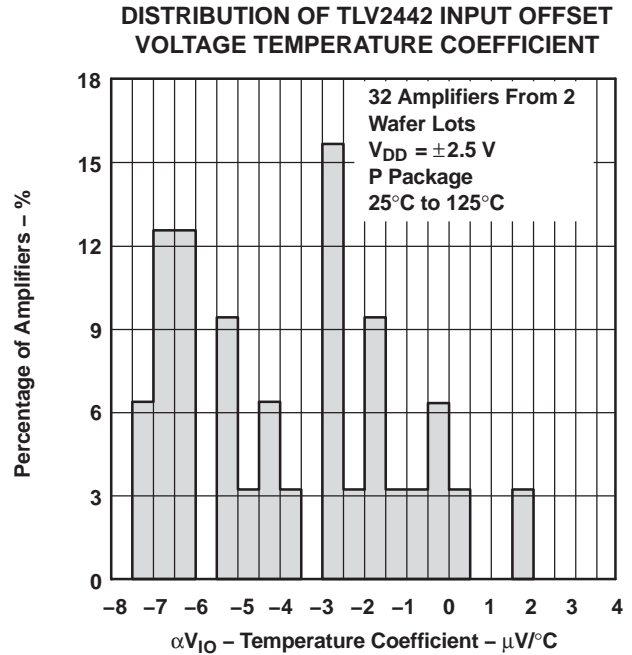

Figure 7.

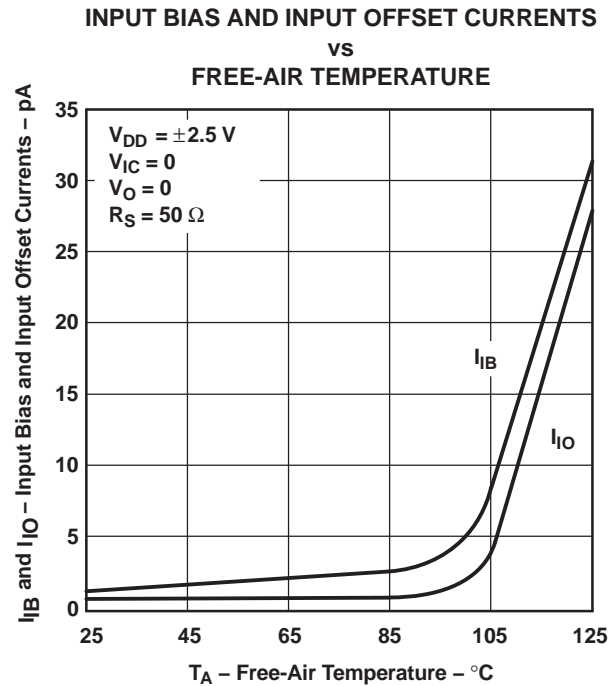

Figure 8.

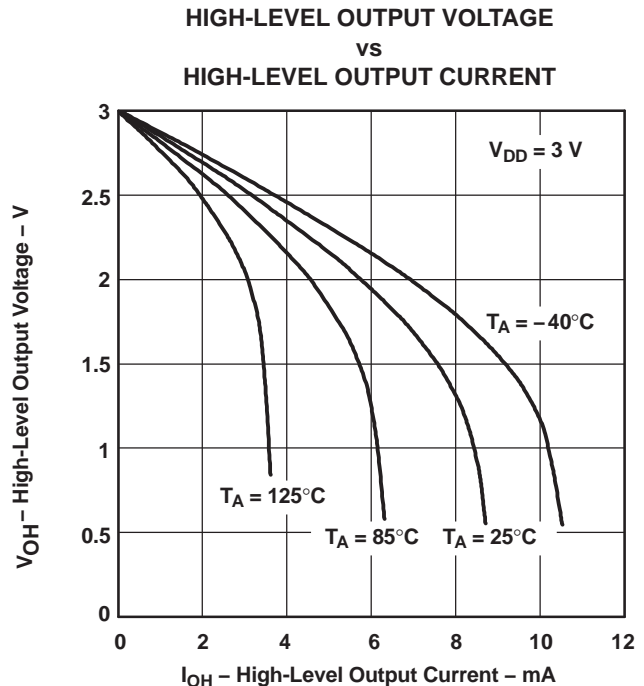
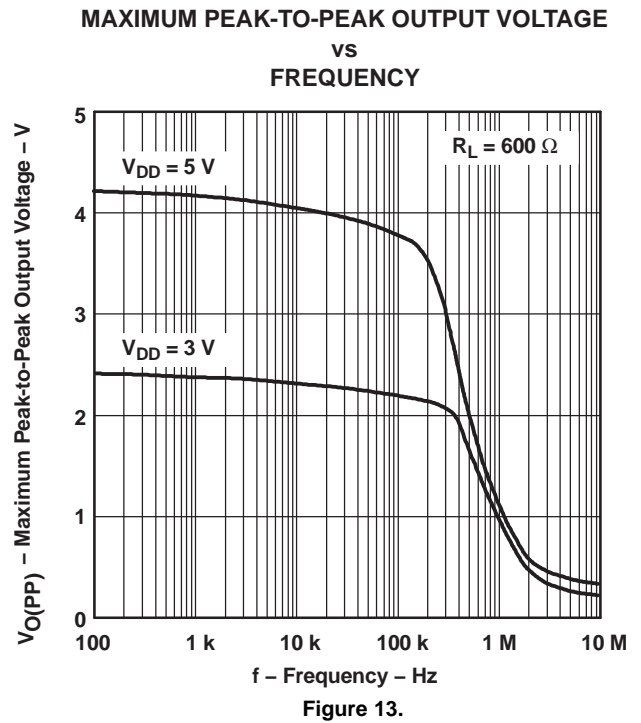
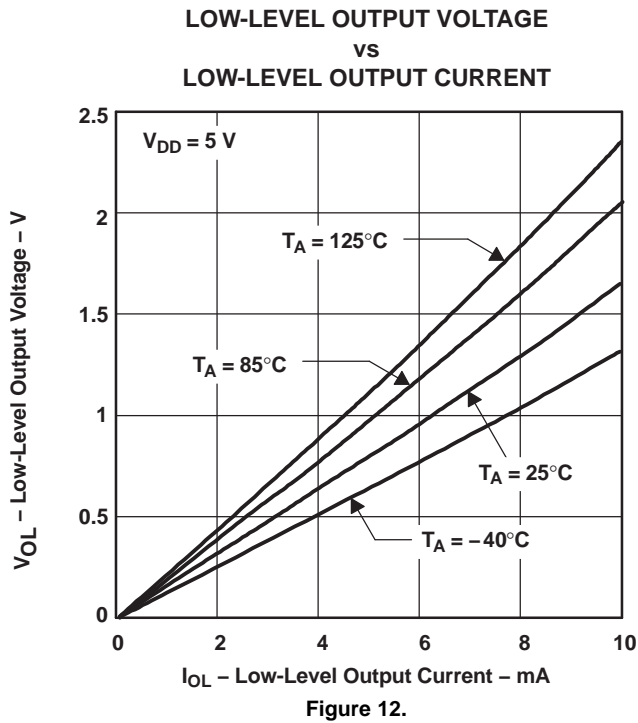
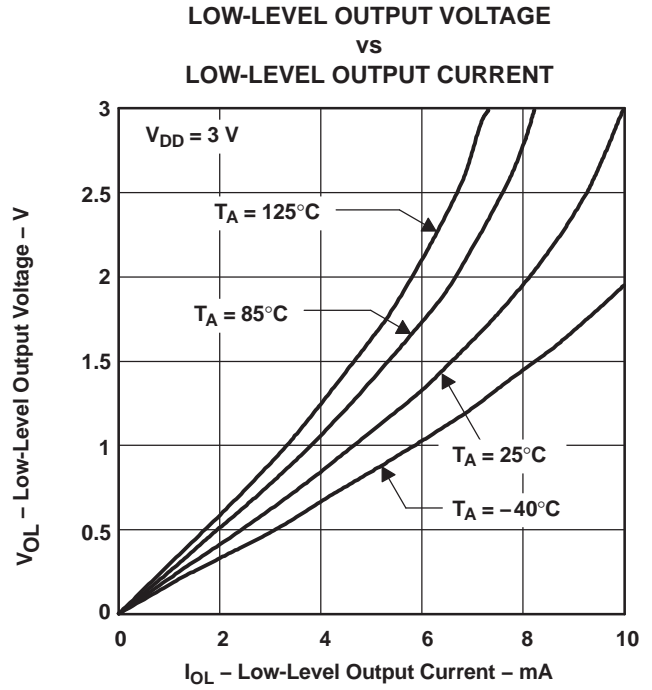
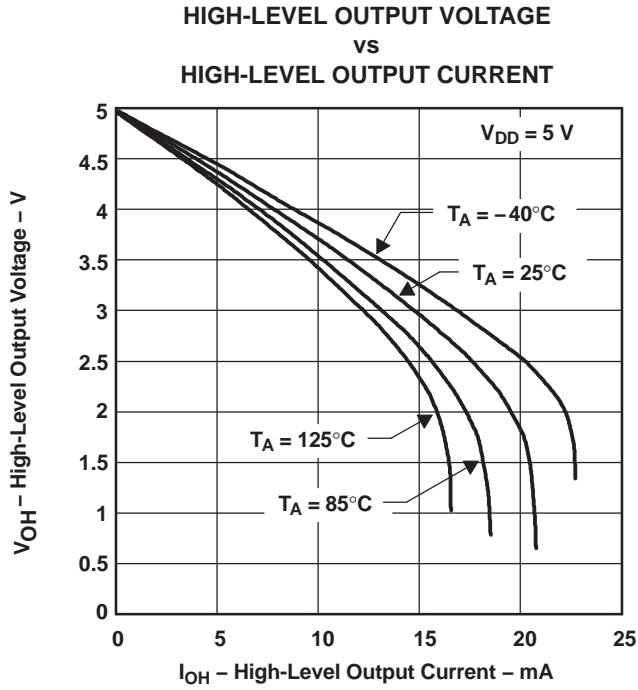

Figure 9.



SHORT-CIRCUIT OUTPUT CURRENT
VS
SUPPLY VOLTAGE

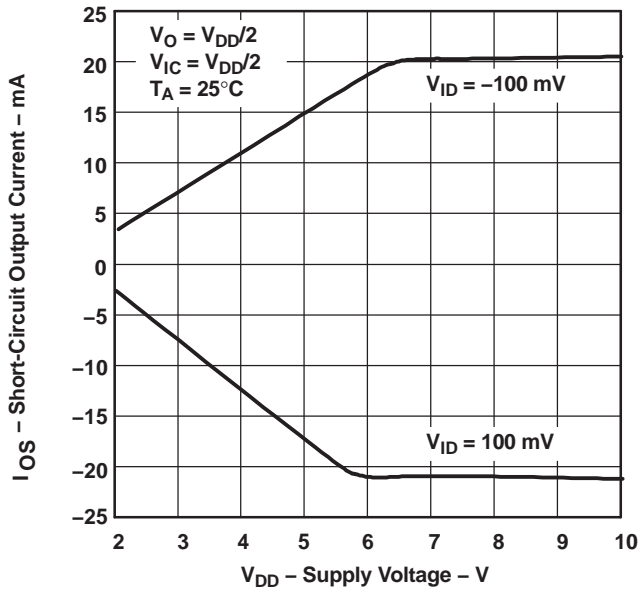

Figure 14.

SHORT-CIRCUIT OUTPUT CURRENT
VS
FREE-AIR TEMPERATURE

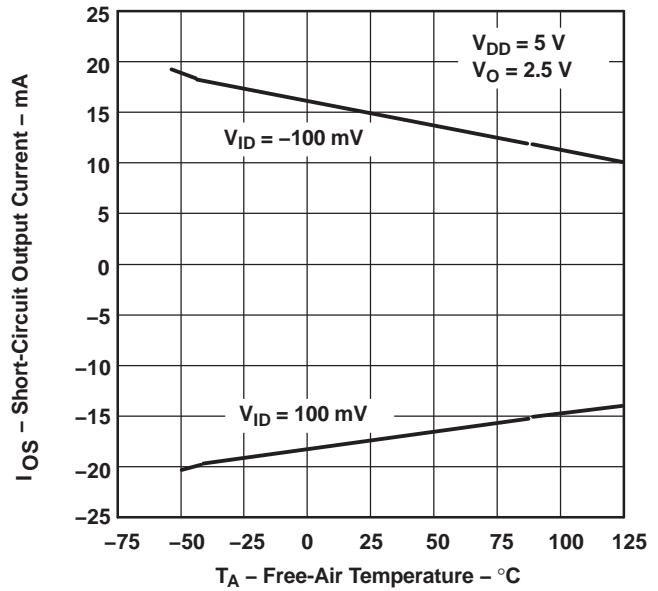

Figure 15.

OUTPUT VOLTAGE
VS
DIFFERENTIAL INPUT VOLTAGE

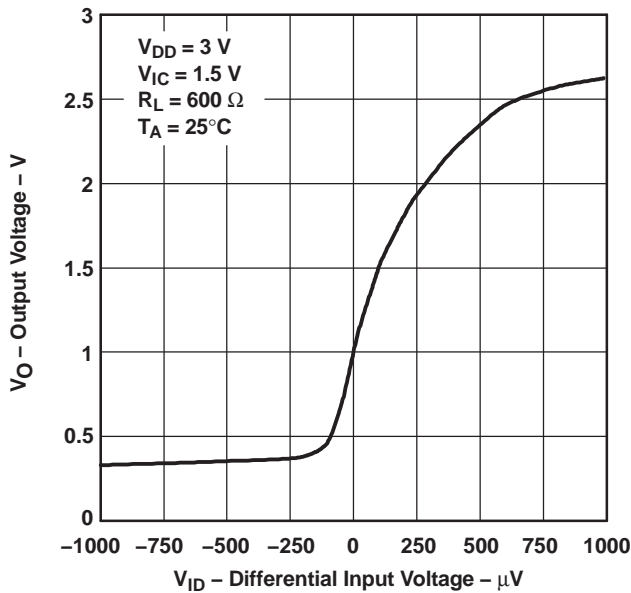

Figure 16.

OUTPUT VOLTAGE
VS
DIFFERENTIAL INPUT VOLTAGE

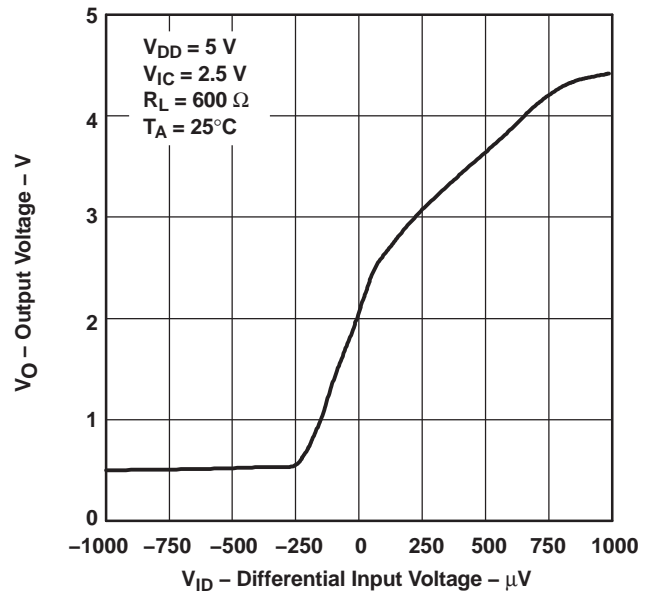
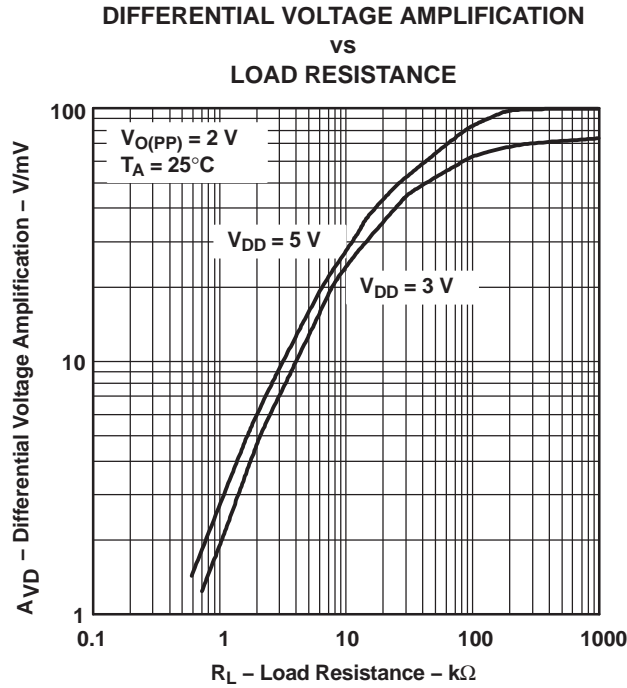

Figure 17.



**Figure 18.
 LARGE-SIGNAL DIFFERENTIAL VOLTAGE
 AMPLIFICATION AND PHASE MARGIN
 vs
 FREQUENCY**

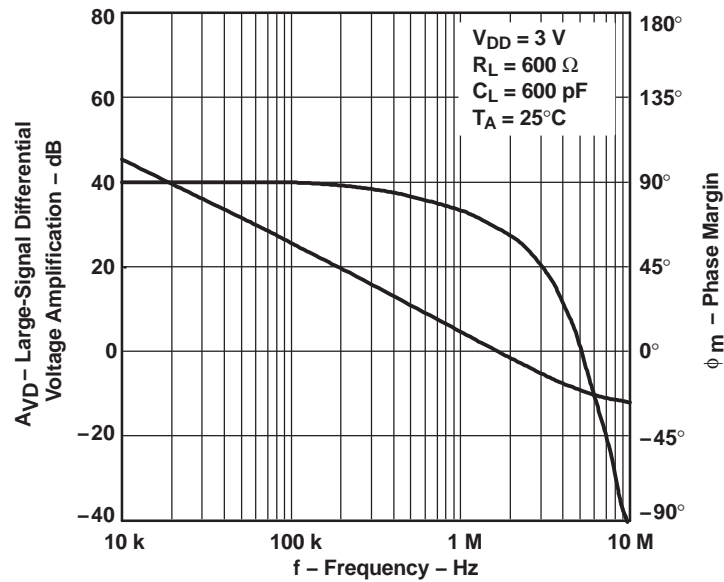

Figure 19.

LARGE-SIGNAL DIFFERENTIAL VOLTAGE AMPLIFICATION AND PHASE MARGIN
vs
FREQUENCY

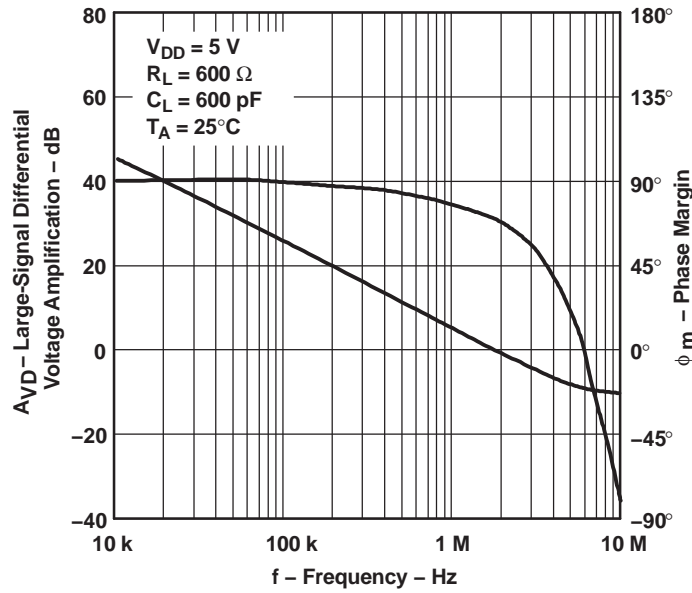

Figure 20.

LARGE-SIGNAL DIFFERENTIAL VOLTAGE AMPLIFICATION
vs
FREE-AIR TEMPERATURE

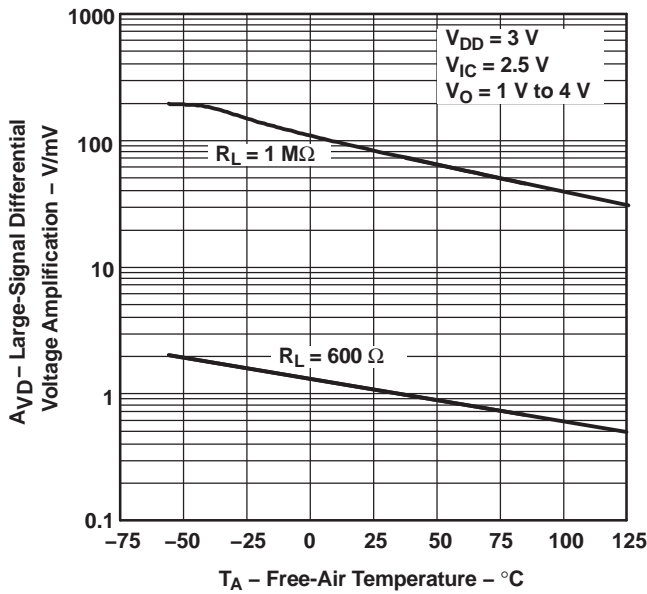

Figure 21.

LARGE-SIGNAL DIFFERENTIAL VOLTAGE AMPLIFICATION
vs
FREE-AIR TEMPERATURE

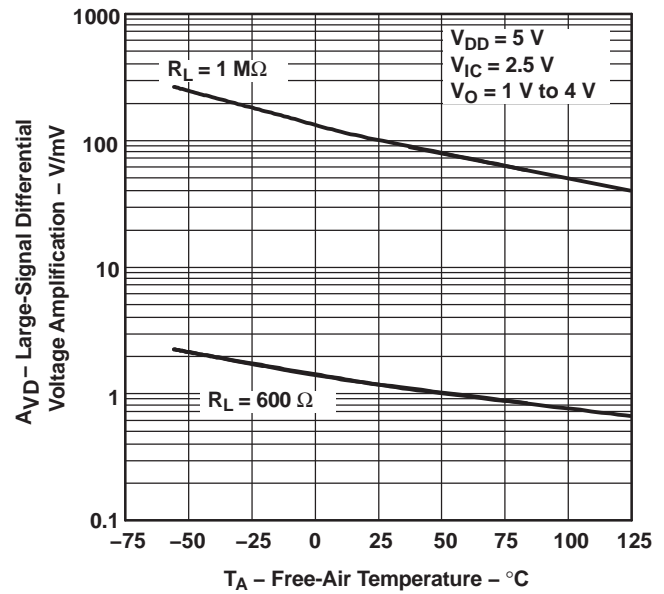

Figure 22.

OUTPUT IMPEDANCE
VS
FREQUENCY

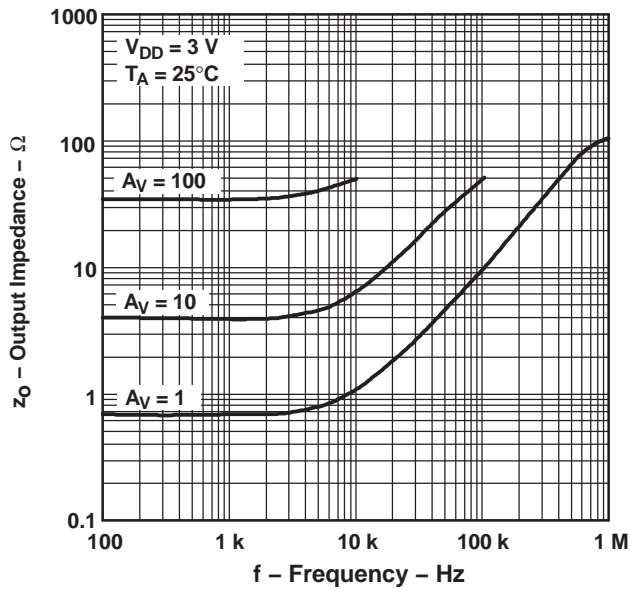

Figure 23.

OUTPUT IMPEDANCE
VS
FREQUENCY

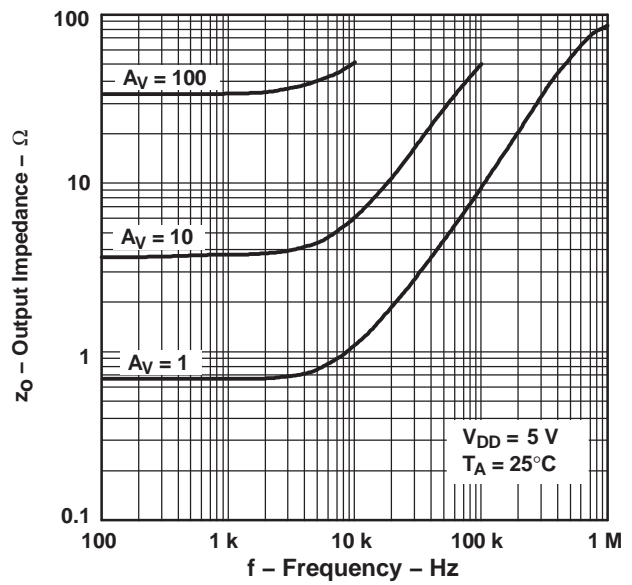

Figure 24.

COMMON-MODE REJECTION RATIO
VS
FREQUENCY

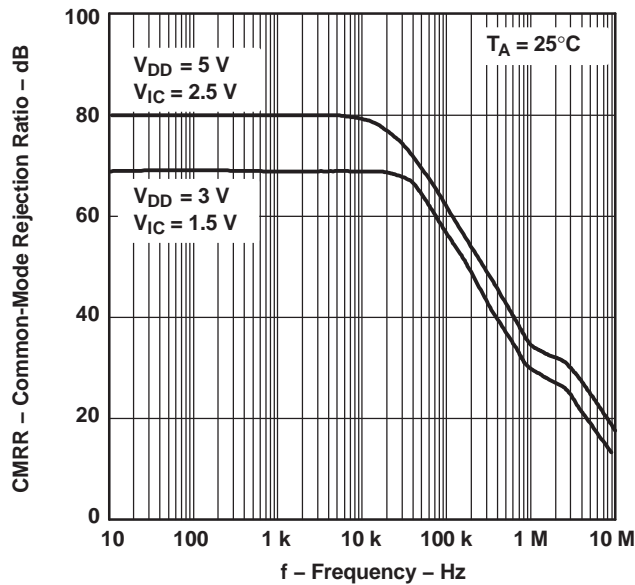

Figure 25.

COMMON-MODE REJECTION RATIO
VS
FREE-AIR TEMPERATURE

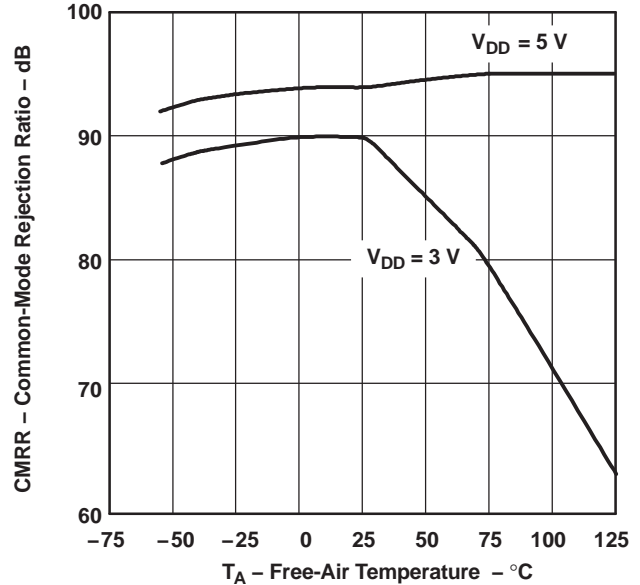

Figure 26.

SUPPLY-VOLTAGE REJECTION RATIO
VS
FREQUENCY

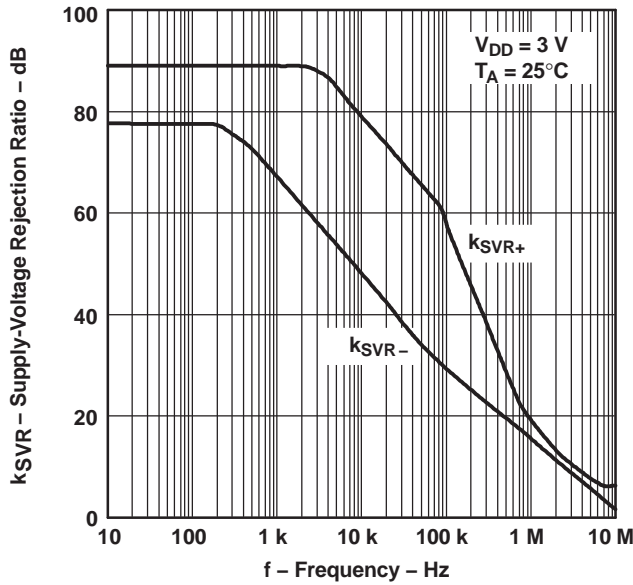

Figure 27.

SUPPLY-VOLTAGE REJECTION RATIO
VS
FREQUENCY

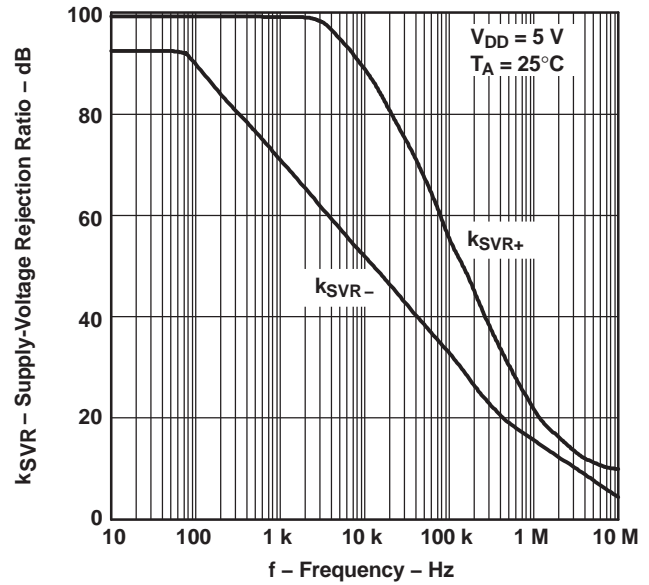

Figure 28.

SUPPLY-VOLTAGE REJECTION RATIO
VS
FREE-AIR TEMPERATURE

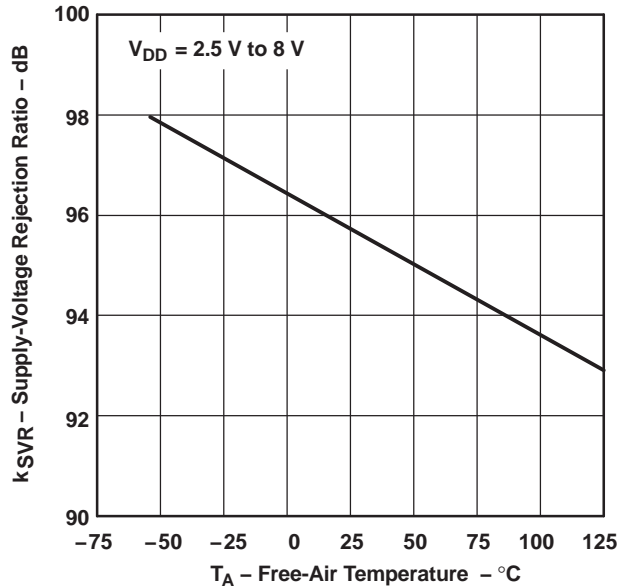

Figure 29.

SUPPLY CURRENT
VS
SUPPLY VOLTAGE

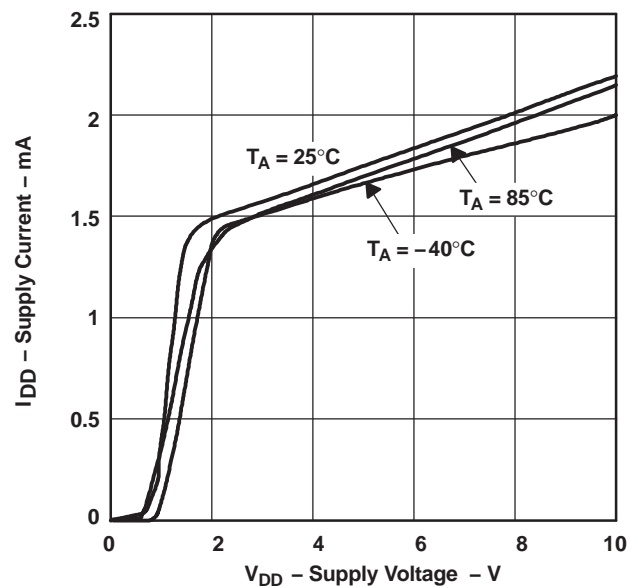
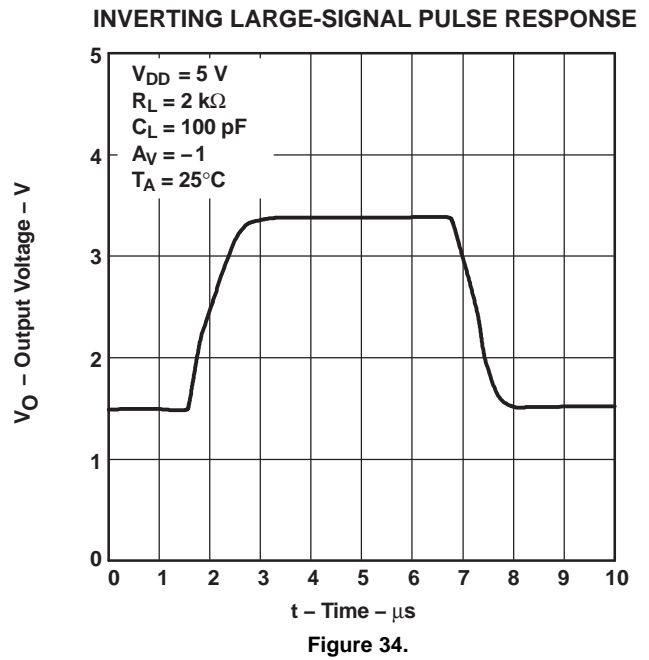
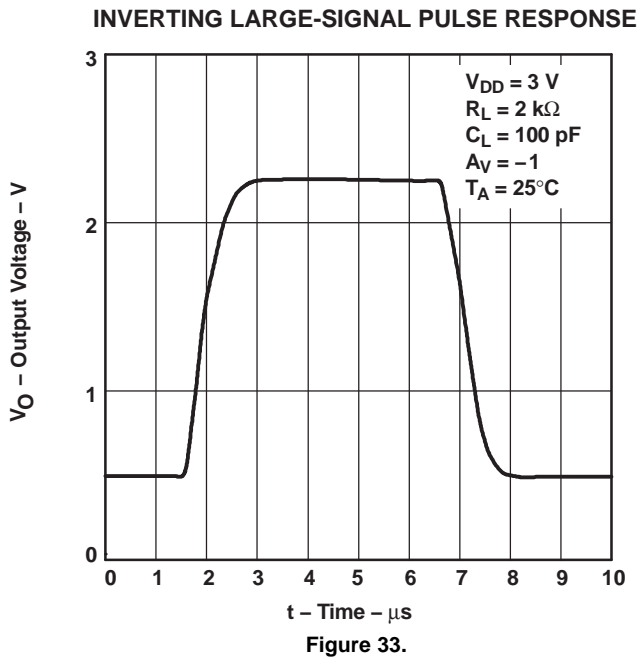
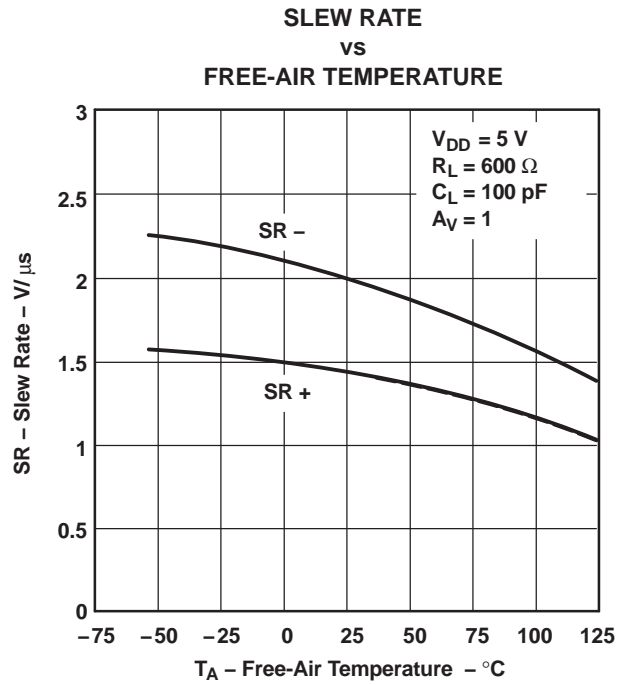
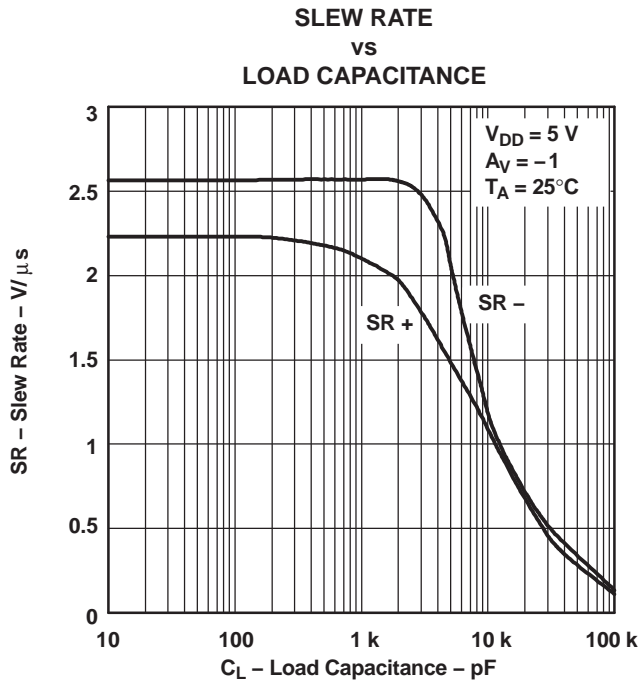

Figure 30.



VOLTAGE-FOLLOWER
LARGE-SIGNAL PULSE RESPONSE

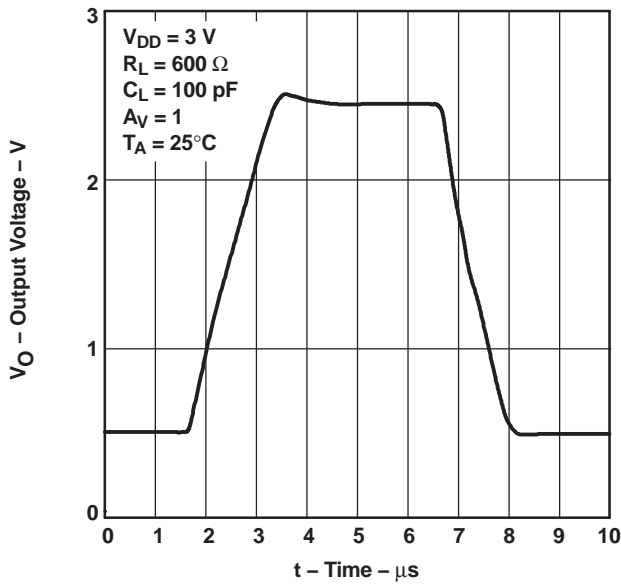

Figure 35.

VOLTAGE-FOLLOWER
LARGE-SIGNAL PULSE RESPONSE

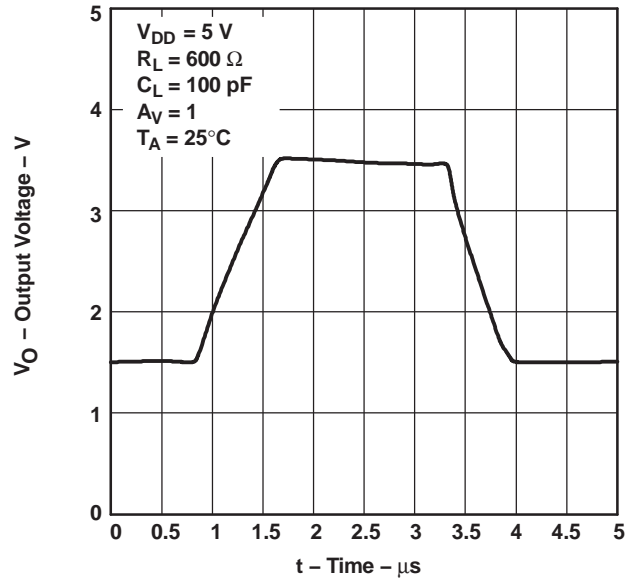

Figure 36.

INVERTING SMALL-SIGNAL PULSE RESPONSE

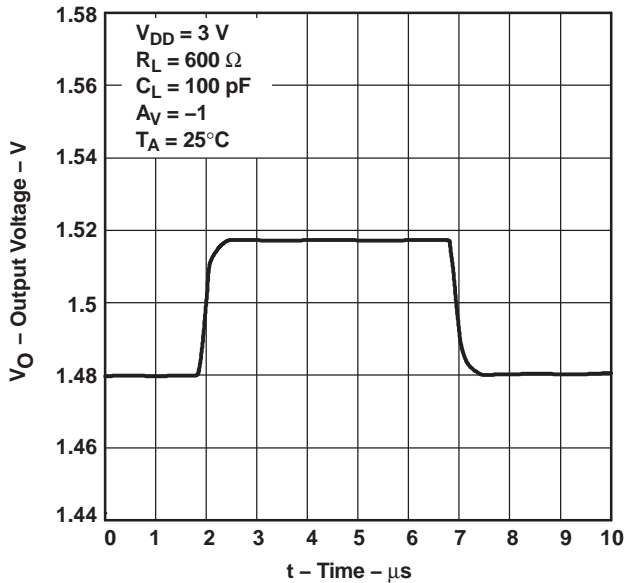

Figure 37.

INVERTING SMALL-SIGNAL PULSE RESPONSE

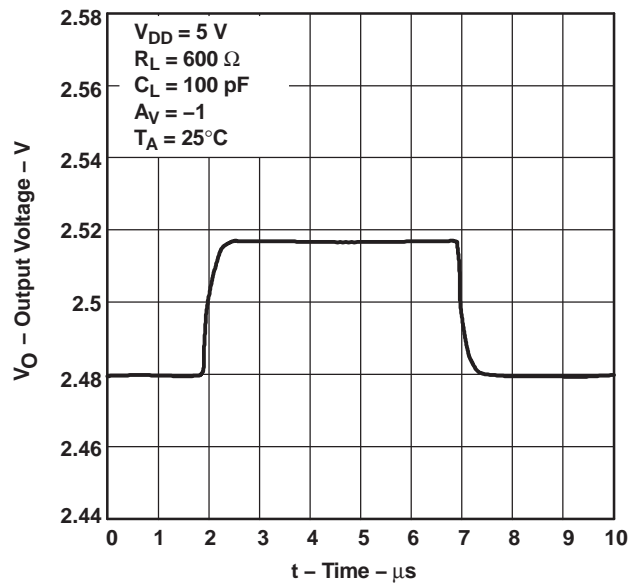

Figure 38.

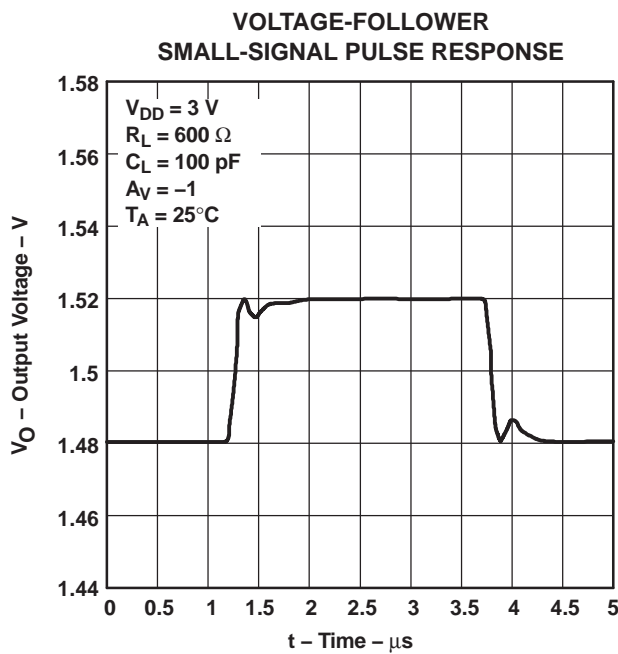

Figure 39.

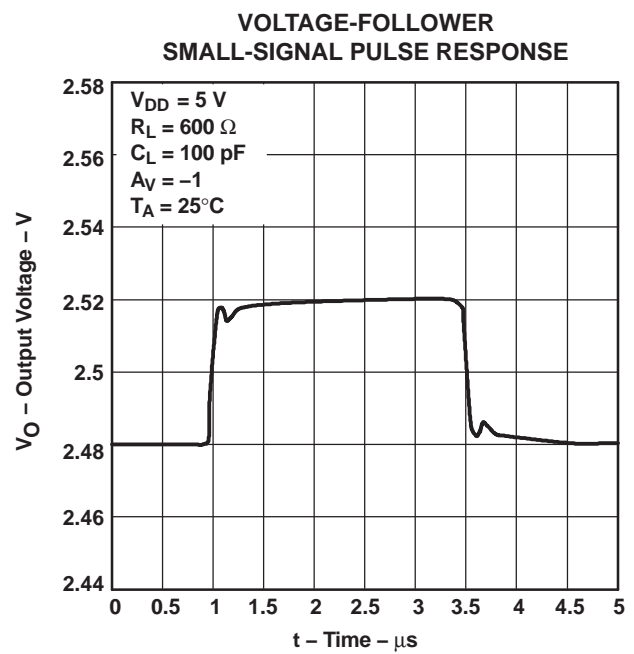

Figure 40.

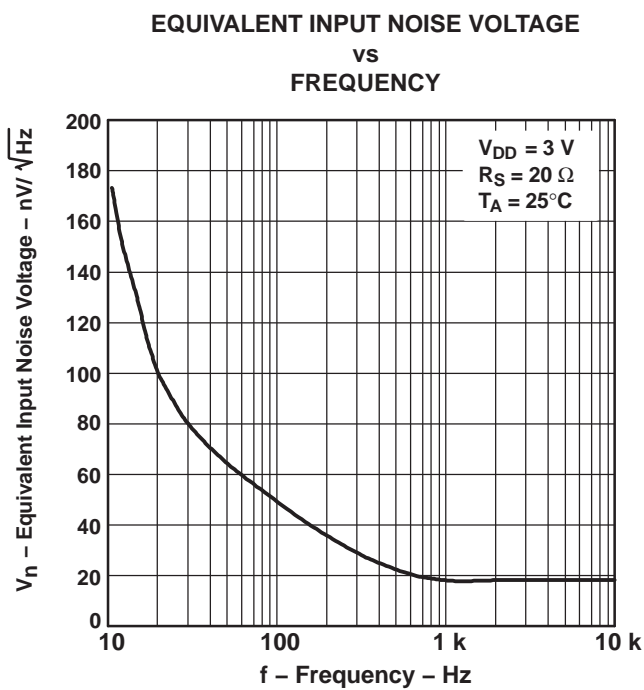

Figure 41.

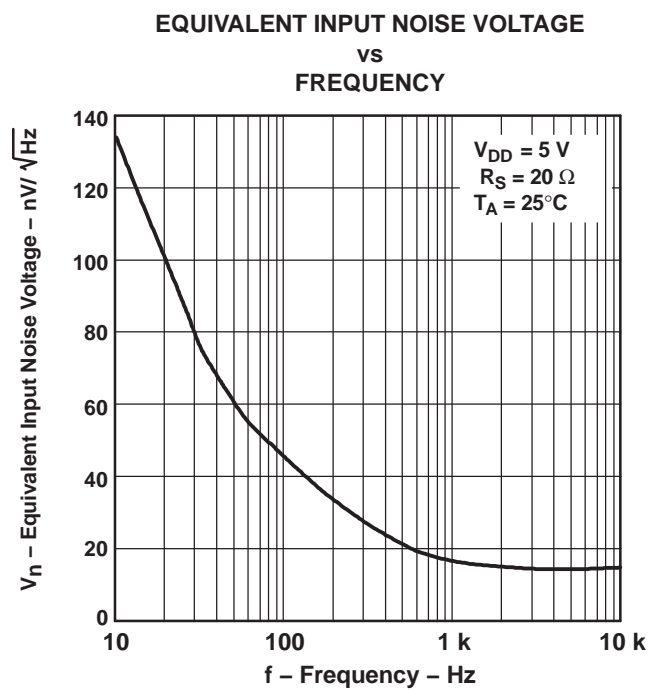

Figure 42.

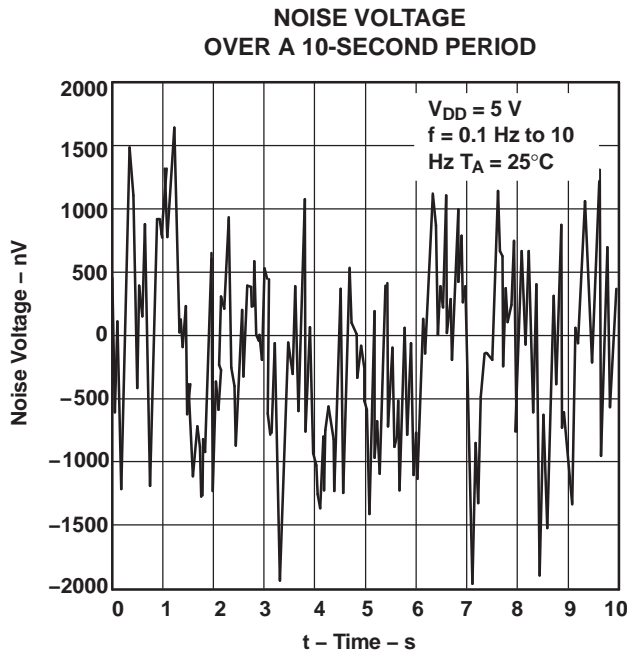

Figure 43.

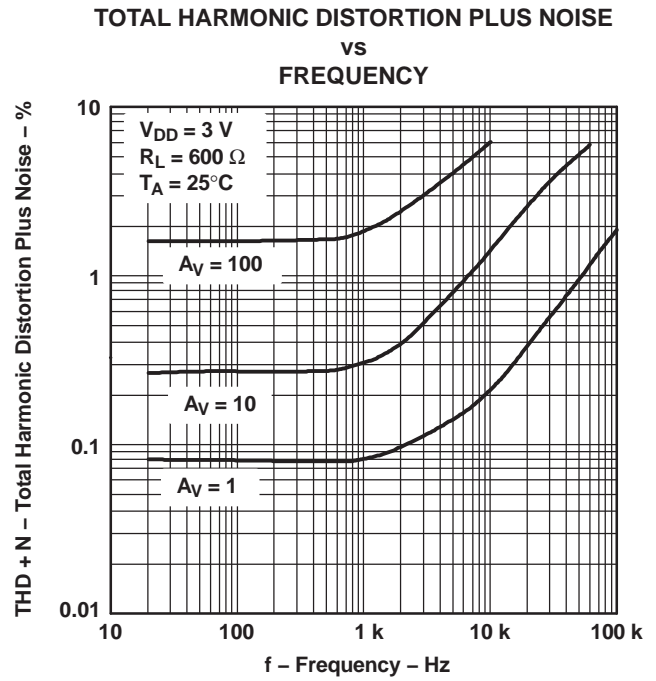

Figure 44.

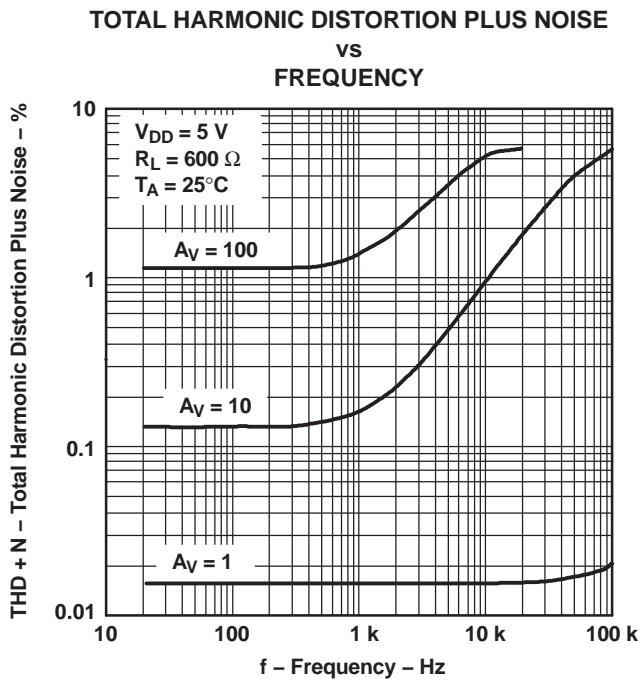

Figure 45.

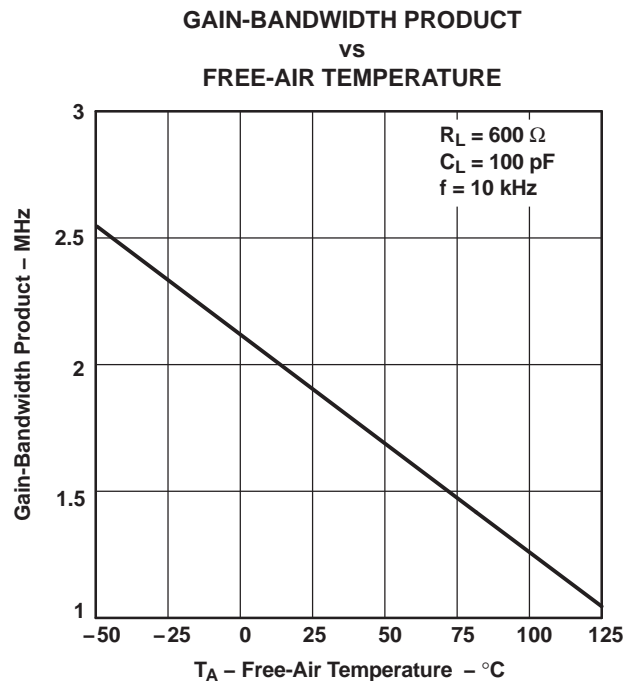

Figure 46.

**GAIN-BANDWIDTH PRODUCT
VS
SUPPLY VOLTAGE**

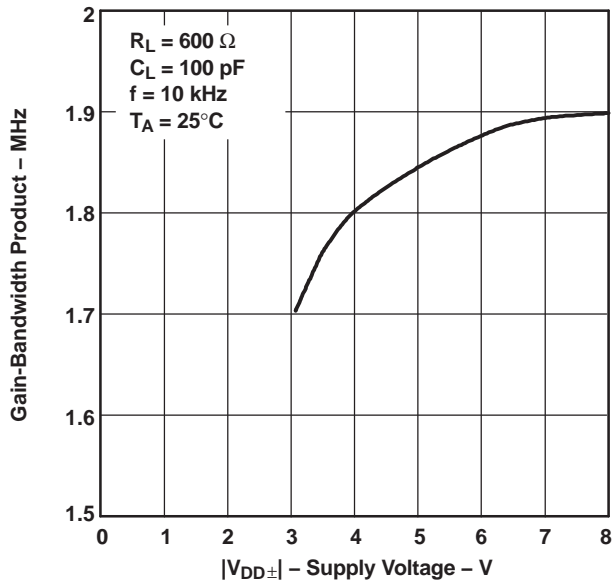

Figure 47.

**PHASE MARGIN
VS
LOAD CAPACITANCE**

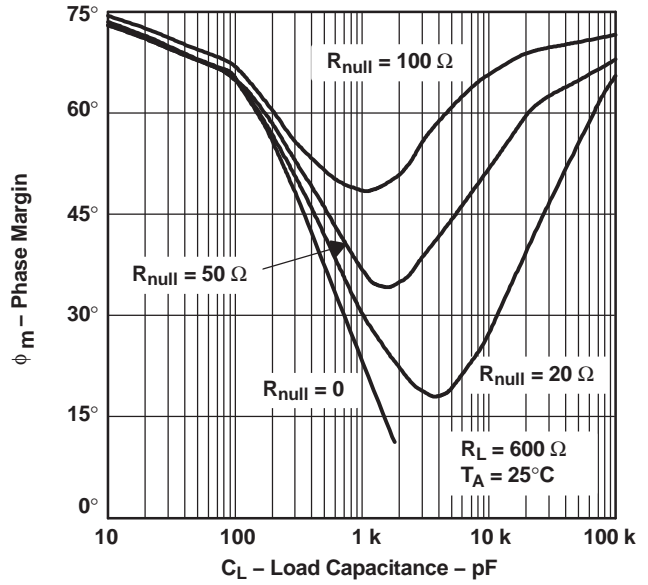

Figure 48.

**GAIN MARGIN
VS
LOAD CAPACITANCE**

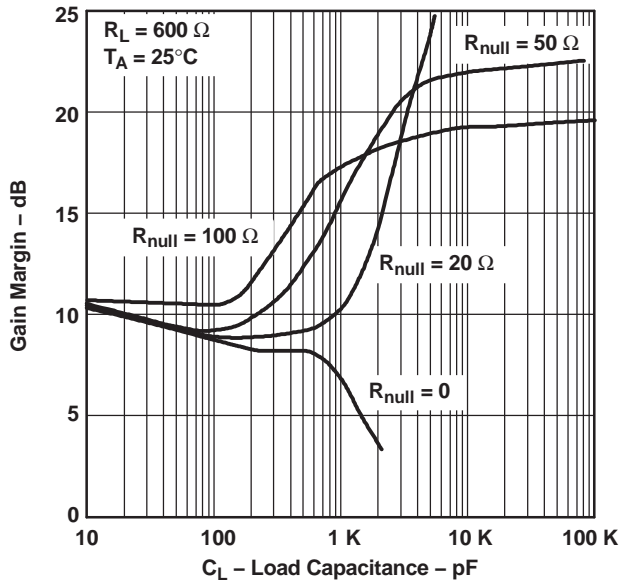

Figure 49.

**UNITY-GAIN BANDWIDTH
VS
LOAD CAPACITANCE**

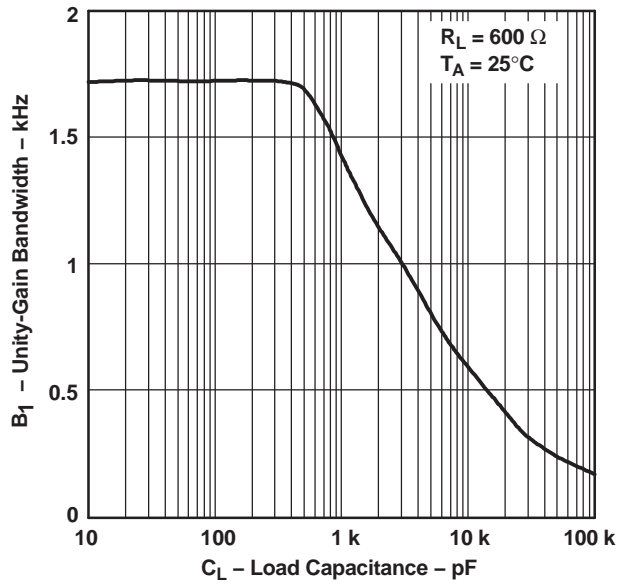

Figure 50.

APPLICATION INFORMATION

macromodel information

Macromodel information provided was derived using PSpice™ Parts™ model generation software. The Boyle macromodel⁽²⁾ and subcircuit in Figure 51 were generated using the TLV244x typical electrical and operating characteristics at T_A = 25°C. Using this information, output simulations of the following key parameters can be generated to a tolerance of 20% (in most cases):

(2) G. R. Boyle, B. M. Cohn, D. O. Pederson, and J. E. Solomon, "Macromodeling of Integrated Circuit Operational Amplifiers," *IEEE Journal of Solid-State Circuits*, SC-9, 353 (1974).

- Maximum positive output voltage swing
- Maximum negative output voltage swing
- Slew rate
- Quiescent power dissipation
- Input bias current
- Open-loop voltage amplification
- Unity gain frequency
- Common-mode rejection ratio
- Phase margin
- DC output resistance
- AC output resistance
- Short-circuit output current limit

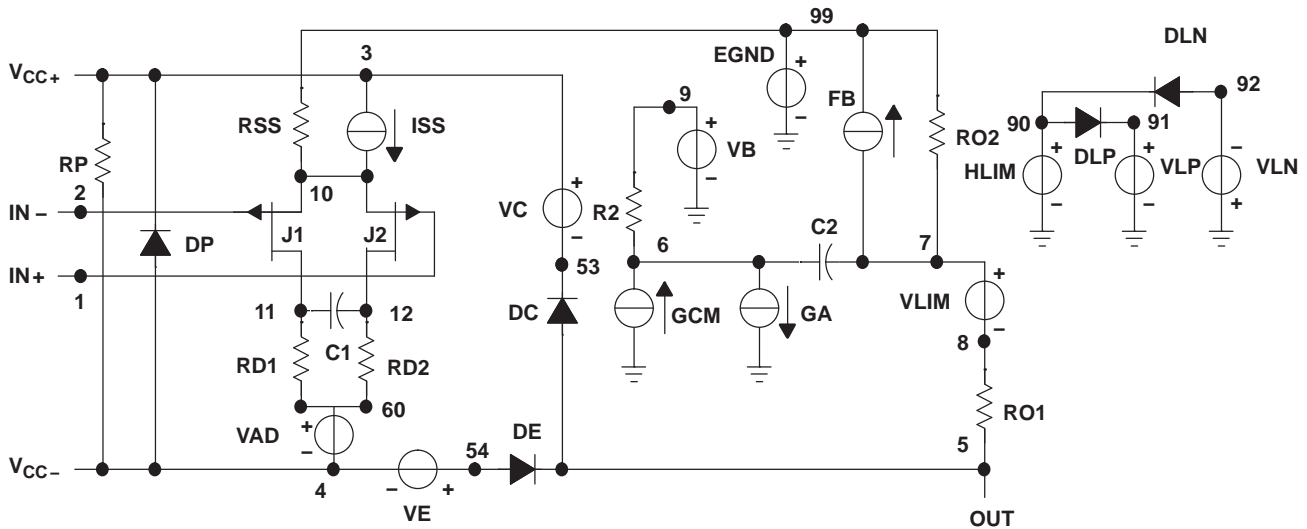

```
.SUBCKT TLV2442 1 2 3 4 5
C1      11      12      14E-12
C2      6       7       60.00E-12
DC      5       53      DX
DE      54      5       DX
DLP     90      91      DX
DLN     92      90      DX
DP      4       3       DX
EGND    99      0       POLY (2) (3,0) (4,) 0 .5 .5
FB      7       99      POLY (5) VB VC VE VLP VLN 0
+ 984.9E3 -1E6 1E6 1E6 -1E6
GA      6       0       11      12 377.0E-6
GCM     0       6       10      99 134E-9
ISS     3       10      DC 216.0E-6
HLIM    90      0       VLIM 1K
J1      11      2       10 JX
J2      12      1       10 JX
R2      6       9       100.OE3
RD1     60      11      2.653E3
RD2     60      12      2.653E3
R01     8       5       50
R02     7       99      50
RP      3       4       4.310E3
RSS     10      99      925.9E3
VAD     60      4       -.5
VB      9       0       DC 0
VC      3       53      DC .78
VE      54      4       DC .78
VLIM    7       8       DC 0
VLP     91      0       DC 1.9
VLN     0       92      DC 9.4
.MODEL DX D (IS=800.0E-18)
.MODEL JX PJF (IS=1.500E-12BETA=1.316E-3
+ VTO=-.270)
.ENDS
```

Figure 51. Boyle Macromodel and Subcircuit

PACKAGING INFORMATION

Orderable Device	Status (1)	Package Type	Package Drawing	Pins	Package Qty	Eco Plan (2)	Lead finish/ Ball material (6)	MSL Peak Temp (3)	Op Temp (°C)	Device Marking (4/5)	Samples
TLV2442AQDRQ1	ACTIVE	SOIC	D	8	2500	RoHS & Green	NIPDAU	Level-1-260C-UNLIM	-40 to 125	2442AQ	Samples
TLV2442QDQGRQ1	ACTIVE	VSSOP	DGK	8	2500	RoHS & Green	Call TI NIPDAUAG NIPDAU	Level-2-260C-1 YEAR	-40 to 125	OBR	Samples
TLV2442QPWRG4Q1	ACTIVE	TSSOP	PW	8	2000	RoHS & Green	NIPDAU	Level-1-260C-UNLIM	-40 to 125	2442Q1	Samples

(1) The marketing status values are defined as follows:

ACTIVE: Product device recommended for new designs.

LIFEBUY: TI has announced that the device will be discontinued, and a lifetime-buy period is in effect.

NRND: Not recommended for new designs. Device is in production to support existing customers, but TI does not recommend using this part in a new design.

PREVIEW: Device has been announced but is not in production. Samples may or may not be available.

OBSELETE: TI has discontinued the production of the device.

(2) **RoHS:** TI defines "RoHS" to mean semiconductor products that are compliant with the current EU RoHS requirements for all 10 RoHS substances, including the requirement that RoHS substance do not exceed 0.1% by weight in homogeneous materials. Where designed to be soldered at high temperatures, "RoHS" products are suitable for use in specified lead-free processes. TI may reference these types of products as "Pb-Free".

RoHS Exempt: TI defines "RoHS Exempt" to mean products that contain lead but are compliant with EU RoHS pursuant to a specific EU RoHS exemption.

Green: TI defines "Green" to mean the content of Chlorine (Cl) and Bromine (Br) based flame retardants meet JS709B low halogen requirements of <=1000ppm threshold. Antimony trioxide based flame retardants must also meet the <=1000ppm threshold requirement.

(3) MSL, Peak Temp. - The Moisture Sensitivity Level rating according to the JEDEC industry standard classifications, and peak solder temperature.

(4) There may be additional marking, which relates to the logo, the lot trace code information, or the environmental category on the device.

(5) Multiple Device Markings will be inside parentheses. Only one Device Marking contained in parentheses and separated by a "~" will appear on a device. If a line is indented then it is a continuation of the previous line and the two combined represent the entire Device Marking for that device.

(6) Lead finish/Ball material - Orderable Devices may have multiple material finish options. Finish options are separated by a vertical ruled line. Lead finish/Ball material values may wrap to two lines if the finish value exceeds the maximum column width.

Important Information and Disclaimer:The information provided on this page represents TI's knowledge and belief as of the date that it is provided. TI bases its knowledge and belief on information provided by third parties, and makes no representation or warranty as to the accuracy of such information. Efforts are underway to better integrate information from third parties. TI has taken and continues to take reasonable steps to provide representative and accurate information but may not have conducted destructive testing or chemical analysis on incoming materials and chemicals. TI and TI suppliers consider certain information to be proprietary, and thus CAS numbers and other limited information may not be available for release.

In no event shall TI's liability arising out of such information exceed the total purchase price of the TI part(s) at issue in this document sold by TI to Customer on an annual basis.

OTHER QUALIFIED VERSIONS OF TLV2442-Q1, TLV2442A-Q1 :

- Catalog : [TLV2442](#), [TLV2442A](#)
- Military : [TLV2442M](#), [TLV2442AM](#)

NOTE: Qualified Version Definitions:

- Catalog - TI's standard catalog product
- Military - QML certified for Military and Defense Applications

TAPE AND REEL INFORMATION

QUADRANT ASSIGNMENTS FOR PIN 1 ORIENTATION IN TAPE

*All dimensions are nominal

Device	Package Type	Package Drawing	Pins	SPQ	Reel Diameter (mm)	Reel Width W1 (mm)	A0 (mm)	B0 (mm)	K0 (mm)	P1 (mm)	W (mm)	Pin1 Quadrant
TLV2442QPWRG4Q1	TSSOP	PW	8	2000	330.0	12.4	7.0	3.6	1.6	8.0	12.0	Q1

TAPE AND REEL BOX DIMENSIONS

*All dimensions are nominal

Device	Package Type	Package Drawing	Pins	SPQ	Length (mm)	Width (mm)	Height (mm)
TLV2442QPWRG4Q1	TSSOP	PW	8	2000	367.0	367.0	35.0



D0008A

PACKAGE OUTLINE

SOIC - 1.75 mm max height

SMALL OUTLINE INTEGRATED CIRCUIT



4214825/C 02/2019

NOTES:

1. Linear dimensions are in inches [millimeters]. Dimensions in parenthesis are for reference only. Controlling dimensions are in inches. Dimensioning and tolerancing per ASME Y14.5M.
2. This drawing is subject to change without notice.
3. This dimension does not include mold flash, protrusions, or gate burrs. Mold flash, protrusions, or gate burrs shall not exceed $.006$ [0.15] per side.
4. This dimension does not include interlead flash.
5. Reference JEDEC registration MS-012, variation AA.

EXAMPLE BOARD LAYOUT

D0008A

SOIC - 1.75 mm max height

SMALL OUTLINE INTEGRATED CIRCUIT



LAND PATTERN EXAMPLE
 EXPOSED METAL SHOWN
 SCALE:8X



SOLDER MASK DETAILS

4214825/C 02/2019

NOTES: (continued)

- 6. Publication IPC-7351 may have alternate designs.
- 7. Solder mask tolerances between and around signal pads can vary based on board fabrication site.

EXAMPLE STENCIL DESIGN

D0008A

SOIC - 1.75 mm max height

SMALL OUTLINE INTEGRATED CIRCUIT



SOLDER PASTE EXAMPLE
BASED ON .005 INCH [0.125 MM] THICK STENCIL
SCALE:8X

4214825/C 02/2019

NOTES: (continued)

8. Laser cutting apertures with trapezoidal walls and rounded corners may offer better paste release. IPC-7525 may have alternate design recommendations.
9. Board assembly site may have different recommendations for stencil design.

PW0008A



PACKAGE OUTLINE

TSSOP - 1.2 mm max height

SMALL OUTLINE PACKAGE



4221848/A 02/2015

NOTES:

1. All linear dimensions are in millimeters. Any dimensions in parenthesis are for reference only. Dimensioning and tolerancing per ASME Y14.5M.
2. This drawing is subject to change without notice.
3. This dimension does not include mold flash, protrusions, or gate burrs. Mold flash, protrusions, or gate burrs shall not exceed 0.15 mm per side.
4. This dimension does not include interlead flash. Interlead flash shall not exceed 0.25 mm per side.
5. Reference JEDEC registration MO-153, variation AA.

EXAMPLE BOARD LAYOUT

PW0008A

TSSOP - 1.2 mm max height

SMALL OUTLINE PACKAGE



LAND PATTERN EXAMPLE
SCALE:10X



SOLDER MASK DETAILS
NOT TO SCALE

4221848/A 02/2015

NOTES: (continued)

- 6. Publication IPC-7351 may have alternate designs.
- 7. Solder mask tolerances between and around signal pads can vary based on board fabrication site.

EXAMPLE STENCIL DESIGN

PW0008A

TSSOP - 1.2 mm max height

SMALL OUTLINE PACKAGE



SOLDER PASTE EXAMPLE
BASED ON 0.125 mm THICK STENCIL
SCALE:10X

4221848/A 02/2015

NOTES: (continued)

8. Laser cutting apertures with trapezoidal walls and rounded corners may offer better paste release. IPC-7525 may have alternate design recommendations.
9. Board assembly site may have different recommendations for stencil design.

DGK0008A



PACKAGE OUTLINE

VSSOP - 1.1 mm max height

SMALL OUTLINE PACKAGE



4214862/A 04/2023

NOTES:

PowerPAD is a trademark of Texas Instruments.

1. All linear dimensions are in millimeters. Any dimensions in parenthesis are for reference only. Dimensioning and tolerancing per ASME Y14.5M.
2. This drawing is subject to change without notice.
3. This dimension does not include mold flash, protrusions, or gate burrs. Mold flash, protrusions, or gate burrs shall not exceed 0.15 mm per side.
4. This dimension does not include interlead flash. Interlead flash shall not exceed 0.25 mm per side.
5. Reference JEDEC registration MO-187.

EXAMPLE BOARD LAYOUT

DGK0008A

TM VSSOP - 1.1 mm max height

SMALL OUTLINE PACKAGE



LAND PATTERN EXAMPLE
EXPOSED METAL SHOWN
SCALE: 15X



SOLDER MASK DETAILS

4214862/A 04/2023

NOTES: (continued)

6. Publication IPC-7351 may have alternate designs.
7. Solder mask tolerances between and around signal pads can vary based on board fabrication site.
8. Vias are optional depending on application, refer to device data sheet. If any vias are implemented, refer to their locations shown on this view. It is recommended that vias under paste be filled, plugged or tented.
9. Size of metal pad may vary due to creepage requirement.

EXAMPLE STENCIL DESIGN

DGK0008A

TM VSSOP - 1.1 mm max height

SMALL OUTLINE PACKAGE



SOLDER PASTE EXAMPLE
SCALE: 15X

4214862/A 04/2023

NOTES: (continued)

11. Laser cutting apertures with trapezoidal walls and rounded corners may offer better paste release. IPC-7525 may have alternate design recommendations.
12. Board assembly site may have different recommendations for stencil design.

IMPORTANT NOTICE AND DISCLAIMER

TI PROVIDES TECHNICAL AND RELIABILITY DATA (INCLUDING DATA SHEETS), DESIGN RESOURCES (INCLUDING REFERENCE DESIGNS), APPLICATION OR OTHER DESIGN ADVICE, WEB TOOLS, SAFETY INFORMATION, AND OTHER RESOURCES "AS IS" AND WITH ALL FAULTS, AND DISCLAIMS ALL WARRANTIES, EXPRESS AND IMPLIED, INCLUDING WITHOUT LIMITATION ANY IMPLIED WARRANTIES OF MERCHANTABILITY, FITNESS FOR A PARTICULAR PURPOSE OR NON-INFRINGEMENT OF THIRD PARTY INTELLECTUAL PROPERTY RIGHTS.

These resources are intended for skilled developers designing with TI products. You are solely responsible for (1) selecting the appropriate TI products for your application, (2) designing, validating and testing your application, and (3) ensuring your application meets applicable standards, and any other safety, security, regulatory or other requirements.

These resources are subject to change without notice. TI grants you permission to use these resources only for development of an application that uses the TI products described in the resource. Other reproduction and display of these resources is prohibited. No license is granted to any other TI intellectual property right or to any third party intellectual property right. TI disclaims responsibility for, and you will fully indemnify TI and its representatives against, any claims, damages, costs, losses, and liabilities arising out of your use of these resources.

TI's products are provided subject to [TI's Terms of Sale](#) or other applicable terms available either on [ti.com](https://www.ti.com) or provided in conjunction with such TI products. TI's provision of these resources does not expand or otherwise alter TI's applicable warranties or warranty disclaimers for TI products.

TI objects to and rejects any additional or different terms you may have proposed.

Mailing Address: Texas Instruments, Post Office Box 655303, Dallas, Texas 75265
Copyright © 2024, Texas Instruments Incorporated