

SN74LVC126A Quadruple Bus Buffer Gate With 3-State Outputs

1 Features

- Operates from 1.65V to 3.6V
- Specified from -40°C to $+125^{\circ}\text{C}$
- Inputs accept voltages up to 5.5V
- Maximum t_{pd} of 4.7ns at 3.3V
- Typical V_{OLP} (output ground bounce), $<0.8\text{V}$ at $V_{CC} = 3.3\text{V}$, $T_A = 25^{\circ}\text{C}$
- Typical V_{OHV} (output V_{OH} undershoot), $>2\text{V}$ at $V_{CC} = 3.3\text{V}$, $T_A = 25^{\circ}\text{C}$
- Latch-up performance exceeds 250mA per JESD 17

2 Applications

- AV Receivers
- Audio Docks: Portable
- Blu-ray Players and Home Theaters
- MP3 Players or Recorders
- Personal Digital Assistants (PDAs)
- Power: Telecom, Server, and AC-DC Supplies (Single-Controller, Analog, and Digital)
- Solid State Drives (SSDs): Client and Enterprise
- TVs: LCD, Digital, and High-Definition (HDTV)
- Tablets: Enterprise
- Video Analytics: Server
- Wireless Headsets, Keyboards, and Mice

3 Description

The SN74LVC126A device is a quadruple bus buffer gate designed for 1.65V to 3.6V V_{CC} operation.

The SN74LVC126A device features independent line drivers with 3-state outputs. Each output is disabled when the associated output-enable (OE) input is low.

To ensure the high-impedance state during power up or power down, OE must be tied to GND through a pulldown resistor; the minimum value of the resistor is determined by the current-sourcing capability of the driver.

Inputs can be driven from either 3.3V or 5V devices. This feature allows the use of this device as a translator in a mixed 3.3V and 5V system environment.

Package Information

PART NUMBER	PACKAGE ⁽¹⁾	PACKAGE SIZE ⁽²⁾	BODY SIZE ⁽³⁾
SN74LVC126A	BQA (WQFN, 14)	3mm × 2.5mm	3mm × 2.5mm
	D (SOIC, 14)	8.65mm × 6mm	8.65mm × 3.91mm
	DB (SSOP, 14)	6.2mm × 7.8mm	6.20mm × 5.30mm
	DGV (TVSOP, 14)	3.60mm × 6.4mm	3.60mm × 4.40mm
	NS (SOP, 14)	10.2mm × 7.8mm	10.20mm × 5.30mm
	PW (TSSOP, 14)	5mm × 6.4mm	5.00mm × 4.40mm
	RGY (VQFN, 14)	3.50mm × 3.50mm	3.50mm × 3.50mm

- For more information, see [Mechanical, Packaging, and Orderable Information](#).
- The package size (length × width) is a nominal value and includes pins, where applicable.
- The body size (length × width) is a nominal value and does not include pins.

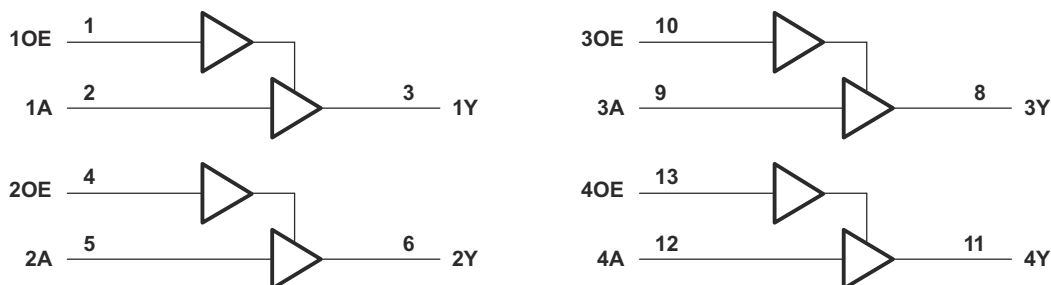

Copyright © 2016, Texas Instruments Incorporated

Simplified Schematic



Table of Contents

1 Features	1	7.4 Device Functional Modes.....	10
2 Applications	1	8 Application and Implementation	11
3 Description	1	8.1 Application Information.....	11
4 Pin Configuration and Functions	3	8.2 Typical Application.....	11
5 Specifications	4	8.3 Power Supply Recommendations.....	12
5.1 Absolute Maximum Ratings.....	4	8.4 Layout.....	12
5.2 ESD Ratings.....	4	9 Device and Documentation Support	14
5.3 Recommended Operating Conditions.....	4	9.1 Documentation Support.....	14
5.4 Thermal Information.....	5	9.2 Receiving Notification of Documentation Updates....	14
5.5 Electrical Characteristics.....	6	9.3 Support Resources.....	14
5.6 Switching Characteristics.....	7	9.4 Trademarks.....	14
5.7 Typical Characteristics.....	8	9.5 Electrostatic Discharge Caution.....	14
6 Parameter Measurement Information	9	9.6 Glossary.....	14
7 Detailed Description	10	10 Revision History	14
7.1 Overview.....	10	11 Mechanical, Packaging, and Orderable Information	14
7.2 Functional Block Diagram.....	10		
7.3 Feature Description.....	10		

4 Pin Configuration and Functions

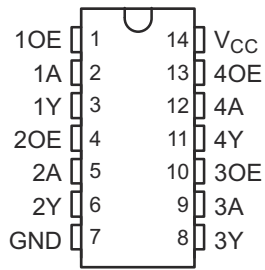

Figure 4-1. SN74LVC126A D, DB, DGV, NS, or PW Package; 14-Pin SOIC, SSOP, TVSOP, SOP or TSSOP (Top View)

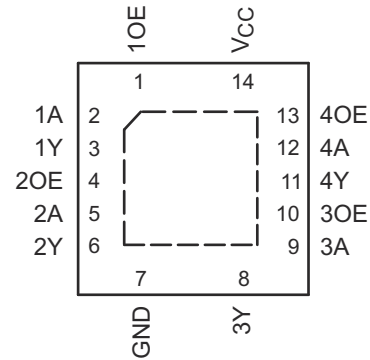

Figure 4-2. SN74LVC126A BQA or RGY Package; 14-Pin WQFN or VQFN (Top View)

Table 4-1. Pin Functions

PIN		I/O ⁽¹⁾	DESCRIPTION
NO.	NAME		
1	1OE	I	Output enable 1
2	1A	I	Gate 1 input
3	1Y	O	Gate 1 output
4	2OE	I	Output enable 2
5	2A	I	Gate 2 input
6	2Y	O	Gate 2 output
7	GND	—	Ground pin
8	3Y	O	Gate 3 output
9	3A	I	Gate 3 input
10	3OE	I	Output enable 3
11	4Y	O	Gate 4 output
12	4A	I	Gate 4 input
13	4OE	I	Output Enable 4
14	V _{CC}	—	Power pin
Thermal pad		—	Connect the GND pin to the exposed thermal pad for correct operation. Connect the thermal pad to any internal PCB ground plane using multiple vias for good thermal performance.

(1) I = input, O = output, P = power, FB = feedback, GND = ground, N/A = not applicable

5 Specifications

5.1 Absolute Maximum Ratings

over operating free-air temperature range (unless otherwise noted)⁽¹⁾

			MIN	MAX	UNIT
V _{CC}	Supply voltage		-0.5	6.5	V
V _I ⁽²⁾	Input voltage		-0.5	6.5	V
V _O ^{(2) (3)}	Output voltage		-0.5	V _{CC} + 0.5	V
I _{IK}	Input clamp current	V _I < 0		-50	mA
I _{OK}	Output clamp current	V _O < 0		-50	mA
I _O	Continuous output current			±50	mA
	Continuous current through V _{CC} or GND			±100	mA
P _{tot}	Power dissipation	T _A = -40°C to +125°C ^{(4) (5)}		500	mW
T _J	Maximum junction temperature			150	°C
T _{stg}	Storage temperature		-65	150	°C

- (1) Stresses beyond those listed under *Absolute Maximum Ratings* may cause permanent damage to the device. These are stress ratings only, which do not imply functional operation of the device at these or any other conditions beyond those indicated under *Recommended Operating Conditions*. Exposure to absolute-maximum-rated conditions for extended periods may affect device reliability.
- (2) The input and output negative-voltage ratings may be exceeded if the input and output current ratings are observed.
- (3) The value of V_{CC} is provided in *Recommended Operating Conditions*.
- (4) For the D package: above 70°C, the value of P_{tot} derates linearly with 8 mW/K.
- (5) For the DB, NS, and PW packages: above 60°C, the value of P_{tot} derates linearly with 5.5 mW/K.

5.2 ESD Ratings

		VALUE	UNIT
V _(ESD)	Electrostatic discharge	Human-body model (HBM), per ANSI/ESDA/JEDEC JS-001 ⁽¹⁾	±2000
		Charged-device model (CDM), per JEDEC specification JESD22-C101 ⁽²⁾	±1500

- (1) JEDEC document JEP155 states that 500-V HBM allows safe manufacturing with a standard ESD control process. This rating was tested on the D (SOIC) package.
- (2) JEDEC document JEP157 states that 250-V CDM allows safe manufacturing with a standard ESD control process. This rating was tested on the D (SOIC) package.

5.3 Recommended Operating Conditions

over operating free-air temperature range (unless otherwise noted)⁽¹⁾

			MIN	NOM	MAX	UNIT
V _{CC}	Supply voltage	Operating	1.65		3.6	V
		Data retention only	1.5			
V _{IH}	High-level input voltage	V _{CC} = 1.65 V to 1.95 V	0.65 × V _{CC}			V
		V _{CC} = 2.3 V to 2.7 V	1.7			
		V _{CC} = 2.7 V to 3.6 V	2			
V _{IL}	Low-level input voltage	V _{CC} = 1.65 V to 1.95 V			0.35 × V _{CC}	V
		V _{CC} = 2.3 V to 2.7 V			0.7	
		V _{CC} = 2.7 V to 3.6 V			0.8	
V _I	Input voltage		0		5.5	V
V _O	Output voltage		0		V _{CC}	V
I _{OH}	High-level output current	V _{CC} = 1.65 V			-4	mA
		V _{CC} = 2.3 V			-8	
		V _{CC} = 2.7 V			-12	
		V _{CC} = 3 V			-24	

5.3 Recommended Operating Conditions (continued)

over operating free-air temperature range (unless otherwise noted)⁽¹⁾

		MIN	NOM	MAX	UNIT	
I _{OL}	Low-level output current	V _{CC} = 1.65 V			4	mA
		V _{CC} = 2.3 V			8	
		V _{CC} = 2.7 V			12	
		V _{CC} = 3 V			24	
Δt/Δv	Input transition rise or fall rate				10	ns/V
T _A	Operating free-air temperature	-40			125	°C

(1) All unused inputs of the device must be held at V_{CC} or GND to ensure proper device operation. See the TI application report, [Implications of Slow or Floating CMOS Inputs](#).

5.4 Thermal Information

THERMAL METRIC ⁽¹⁾	SN74LVC126A							UNIT	
	BQA (WQFN)	D (SOIC)	DB (SSOP)	DGV (TVSOP)	NS (SOP)	PW (TSSOP)	RGY (VQFN)		
	14 PINS	14 PINS	14 PINS	14 PINS	14 PINS	14 PINS	14 PINS		
R _{θJA}	Junction-to-ambient thermal resistance	102.3 ⁽³⁾	127.8 ⁽²⁾	112.2 ⁽²⁾	140.9 ⁽²⁾	123.8 ⁽²⁾	150.8 ⁽²⁾	92.1 ⁽³⁾	°C/W
R _{θJC(top)}	Junction-to-case (top) thermal resistance	96.8	81.9	64.2	59.9	51.7	78.3	91.8	°C/W
R _{θJB}	Junction-to-board thermal resistance	70.9	84.4	59.6	70.2	52.7	93.8	66.7	°C/W
Ψ _{JT}	Junction-to-top characterization parameter	16.6	39.6	28.3	9.1	20.7	38.2	20	°C/W
Ψ _{JB}	Junction-to-board characterization parameter	70.9	83.9	59.1	69.5	52.3	93.2	66.5	°C/W
R _{θJC(bot)}	Junction-to-case (bottom) thermal resistance	50.1	N/A	N/A	N/A	N/A	N/A	50.1	°C/W

- (1) For more information about traditional and new thermal metrics, see the [Semiconductor and IC Package Thermal Metrics](#) application report.
- (2) The package thermal impedance is calculated in accordance with JESD 51-7.
- (3) The package thermal impedance is calculated in accordance with JESD 51-5.

5.5 Electrical Characteristics

over recommended operating free-air temperature range (unless otherwise noted)

PARAMETER	TEST CONDITIONS		MIN	TYP	MAX	UNIT	
V_{OH}	$I_{OH} = -100 \mu A, V_{CC} = 1.65 V \text{ to } 3.6 V$	$T_A = 25^\circ C$	$V_{CC} - 0.2$			V	
		$T_A = -40^\circ C \text{ to } +125^\circ C$	$V_{CC} - 0.3$				
	$I_{OH} = -4 mA, V_{CC} = 1.65 V$	$T_A = 25^\circ C$	1.29				
		$T_A = -40^\circ C \text{ to } +85^\circ C$	1.2				
		$T_A = -40^\circ C \text{ to } +125^\circ C$	1.05				
	$I_{OH} = -8 mA, V_{CC} = 2.3 V$	$T_A = 25^\circ C$	1.9				
		$T_A = -40^\circ C \text{ to } +85^\circ C$	1.7				
		$T_A = -40^\circ C \text{ to } +125^\circ C$	1.55				
	$I_{OH} = -12 mA$	$V_{CC} = 2.7 V$	$T_A = 25^\circ C$	2.2			
			$T_A = -40^\circ C \text{ to } +125^\circ C$	2.05			
		$V_{CC} = 3 V$	$T_A = 25^\circ C$	2.4			
			$T_A = -40^\circ C \text{ to } +125^\circ C$	2.25			
$I_{OH} = -24 mA, V_{CC} = 3 V$	$T_A = 25^\circ C$	2.3					
	$T_A = -40^\circ C \text{ to } +85^\circ C$	2.2					
	$T_A = -40^\circ C \text{ to } +125^\circ C$	2					
V_{OL}	$I_{OL} = 100 \mu A, V_{CC} = 1.65 V \text{ to } 3.6 V$	$T_A = 25^\circ C$			0.1	V	
		$T_A = -40^\circ C \text{ to } +85^\circ C$			0.2		
		$T_A = -40^\circ C \text{ to } +125^\circ C$			0.3		
	$I_{OL} = 4 mA, V_{CC} = 1.65 V$	$T_A = 25^\circ C$			0.24		
		$T_A = -40^\circ C \text{ to } +85^\circ C$			0.45		
		$T_A = -40^\circ C \text{ to } +125^\circ C$			0.6		
	$I_{OL} = 8 mA, V_{CC} = 2.3 V$	$T_A = 25^\circ C$			0.3		
		$T_A = -40^\circ C \text{ to } +85^\circ C$			0.7		
		$T_A = -40^\circ C \text{ to } +125^\circ C$			0.75		
	$I_{OL} = 12 mA, V_{CC} = 2.7 V$	$T_A = 25^\circ C$			0.4		
		$T_A = -40^\circ C \text{ to } +125^\circ C$			0.6		
	$I_{OL} = 24 mA, V_{CC} = 3 V$	$T_A = 25^\circ C$			0.55		
$T_A = -40^\circ C \text{ to } +125^\circ C$				0.8			
I_I	$V_I = 5.5 V \text{ or } GND, V_{CC} = 3.6 V$	$T_A = 25^\circ C$			± 1	μA	
		$T_A = -40^\circ C \text{ to } +85^\circ C$			± 5		
		$T_A = -40^\circ C \text{ to } +125^\circ C$			± 20		
I_{OZ}	$V_O = V_{CC} \text{ or } GND, V_{CC} = 3.6 V$	$T_A = 25^\circ C$			± 1	μA	
		$T_A = -40^\circ C \text{ to } +85^\circ C$			± 10		
		$T_A = -40^\circ C \text{ to } +125^\circ C$			± 20		
I_{CC}	$V_I = V_{CC} \text{ or } GND, I_O = 0, V_{CC} = 3.6 V$	$T_A = 25^\circ C$			1	μA	
		$T_A = -40^\circ C \text{ to } +85^\circ C$			10		
		$T_A = -40^\circ C \text{ to } +125^\circ C$			40		
ΔI_{CC}	One input at $V_{CC} - 0.6 V$, other inputs at V_{CC} or $GND, V_{CC} = 2.7 V \text{ to } 3.6 V$	$T_A = 25^\circ C$			500	μA	
		$T_A = -40^\circ C \text{ to } +125^\circ C$			5000		
C_i	$V_I = V_{CC} \text{ or } GND, V_{CC} = 3.3 V$				4.5	pF	
C_o	$V_O = V_{CC} \text{ or } GND, V_{CC} = 3.3 V$				7	pF	

5.5 Electrical Characteristics (continued)

over recommended operating free-air temperature range (unless otherwise noted)

PARAMETER	TEST CONDITIONS		MIN	TYP	MAX	UNIT
C_{pd} Power dissipation capacitance per gate	f = 10 MHz, $T_A = 25^\circ\text{C}$	Outputs enabled	$V_{CC} = 1.8\text{ V}$		20	pF
			$V_{CC} = 2.5\text{ V}$		21	
			$V_{CC} = 3.3\text{ V}$		22	
		Outputs disabled	$V_{CC} = 1.8\text{ V}$		2	
			$V_{CC} = 2.5\text{ V}$		3	
			$V_{CC} = 3.3\text{ V}$		4	

5.6 Switching Characteristics

over recommended operating free-air temperature range (unless otherwise noted; see [Parameter Measurement Information](#))

PARAMETER	TEST CONDITIONS		MIN	TYP	MAX	UNIT	
t_{pd}	From A (input) to Y (output)	$V_{CC} = 1.8\text{ V} \pm 0.15\text{ V}$	$T_A = 25^\circ\text{C}$	1	4.2	9.3	ns
			$T_A = -40^\circ\text{C to } +85^\circ\text{C}$			9.8	
			$T_A = -40^\circ\text{C to } +125^\circ\text{C}$			11.3	
		$V_{CC} = 2.5\text{ V} \pm 0.2\text{ V}$	$T_A = 25^\circ\text{C}$	1	2.7	6.7	
			$T_A = -40^\circ\text{C to } +85^\circ\text{C}$			7.2	
			$T_A = -40^\circ\text{C to } +125^\circ\text{C}$			9.3	
		$V_{CC} = 2.7\text{ V}$	$T_A = 25^\circ\text{C}$	1	2.9	5	
			$T_A = -40^\circ\text{C to } +85^\circ\text{C}$			5.2	
			$T_A = -40^\circ\text{C to } +125^\circ\text{C}$			6.5	
		$V_{CC} = 3.3\text{ V} \pm 0.3\text{ V}$	$T_A = 25^\circ\text{C}$	1	2.5	4.5	
			$T_A = -40^\circ\text{C to } +85^\circ\text{C}$			4.7	
			$T_A = -40^\circ\text{C to } +125^\circ\text{C}$			6	
t_{en}	From OE (input) to Y (output)	$V_{CC} = 1.8\text{ V} \pm 0.15\text{ V}$	$T_A = 25^\circ\text{C}$	1	4.8	9.5	ns
			$T_A = -40^\circ\text{C to } +85^\circ\text{C}$			10	
			$T_A = -40^\circ\text{C to } +125^\circ\text{C}$			11.5	
		$V_{CC} = 2.5\text{ V} \pm 0.2\text{ V}$	$T_A = 25^\circ\text{C}$	1	2.8	7.8	
			$T_A = -40^\circ\text{C to } +85^\circ\text{C}$			8.3	
			$T_A = -40^\circ\text{C to } +125^\circ\text{C}$			10.4	
		$V_{CC} = 2.7\text{ V}$	$T_A = 25^\circ\text{C}$	1	3.1	6.1	
			$T_A = -40^\circ\text{C to } +85^\circ\text{C}$			6.3	
			$T_A = -40^\circ\text{C to } +125^\circ\text{C}$			8	
		$V_{CC} = 3.3\text{ V} \pm 0.3\text{ V}$	$T_A = 25^\circ\text{C}$	1	2.5	5.5	
			$T_A = -40^\circ\text{C to } +85^\circ\text{C}$			5.7	
			$T_A = -40^\circ\text{C to } +125^\circ\text{C}$			7.5	

5.6 Switching Characteristics (continued)

over recommended operating free-air temperature range (unless otherwise noted; see [Parameter Measurement Information](#))

PARAMETER	TEST CONDITIONS			MIN	TYP	MAX	UNIT
t _{dis}	From OE (input) to Y (output)	V _{CC} = 1.8 V ± 0.15 V	T _A = 25°C	1	4.4	12.1	ns
			T _A = -40°C to +85°C			12.6	
			T _A = -40°C to +125°C			14.1	
		V _{CC} = 2.5 V ± 0.2 V	T _A = 25°C	1	2.7	8.2	
			T _A = -40°C to +85°C			8.7	
			T _A = -40°C to +125°C			10.8	
		V _{CC} = 2.7 V	T _A = 25°C	1	2.7	6.5	
			T _A = -40°C to +85°C			6.7	
			T _A = -40°C to +125°C			8.5	
		V _{CC} = 3.3 V ± 0.3 V	T _A = 25°C	1.3	2.3	5.8	
			T _A = -40°C to +85°C			6	
			T _A = -40°C to +125°C			7.5	
t _{sk(o)}	V _{CC} = 3.3 V ± 0.3 V	T _A = -40°C to +85°C			1	ns	
		T _A = -40°C to +125°C			1.5		

5.7 Typical Characteristics

T_A = 25°C

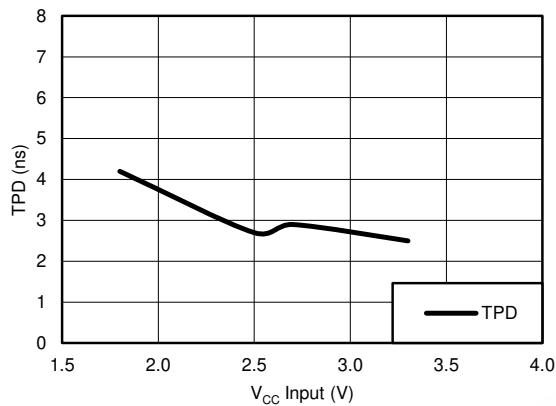

Figure 5-1. TPD vs V_{CC}

6 Parameter Measurement Information

Phase relationships between waveforms were chosen arbitrarily for the examples listed in the following table. All input pulses are supplied by generators having the following characteristics: PRR ≤ 1MHz, Z_O = 50Ω, t_t ≤ 2.5ns.

The outputs are measured individually with one input transition per measurement.

TEST	S1	S2	R _L	C _L	ΔV	V _{LOAD}
t _{PLH} , t _{PHL}	OPEN	OPEN	500Ω	50pF	—	—
t _{PLZ} , t _{PZL}	CLOSED	OPEN	500Ω	50pF	0.3V	2×V _{CC}
t _{PHZ} , t _{PZH}	OPEN	CLOSED	500Ω	50pF	0.3V	—

V _{CC}	V _t	R _L	C _L	ΔV	V _{LOAD}
1.8V ± 0.15V	V _{CC} /2	1kΩ	30pF	0.15V	2×V _{CC}
2.5V ± 0.2V	V _{CC} /2	500Ω	30pF	0.15V	2×V _{CC}
2.7V	1.5V	500Ω	50pF	0.3V	6V
3.3V ± 0.3V	1.5V	500Ω	50pF	0.3V	6V

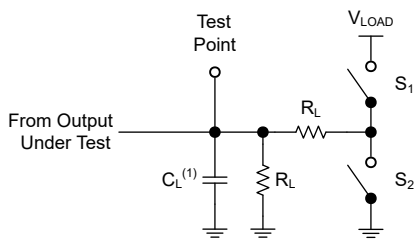

(1) C_L includes probe and test-fixture capacitance.

Figure 6-1. Load Circuit for 3-State Outputs

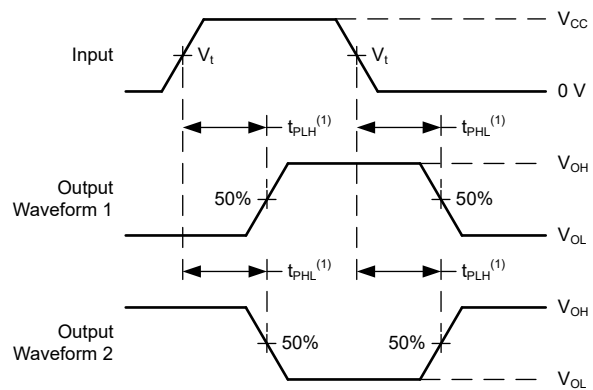

(1) The greater between t_{PLH} and t_{PHL} is the same as t_{pd}.

Figure 6-2. Voltage Waveforms Propagation Delays

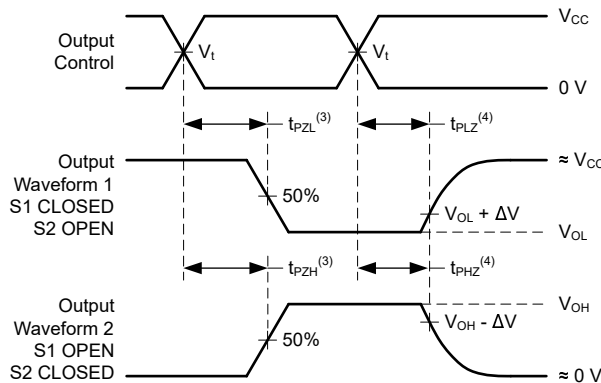

(1) The greater between t_{PZL} and t_{PZH} is the same as t_{en}.

(2) The greater between t_{PLZ} and t_{PHZ} is the same as t_{dis}.

Figure 6-3. Voltage Waveforms Propagation Delays

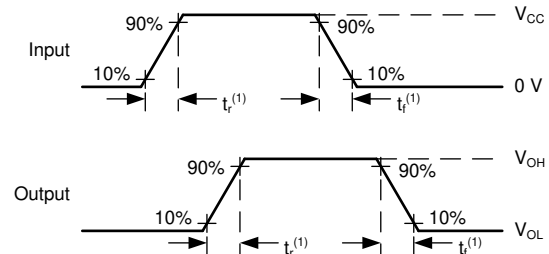

(1) The greater between t_r and t_f is the same as t_t.

Figure 6-4. Voltage Waveforms, Input and Output Transition Times

7 Detailed Description

7.1 Overview

The SN74LVC126A quadruple buffer is designed for 1.65-V to 3.6-V V_{CC} operation and features tri-state outputs.

The SN74LVC126A devices perform the Boolean function $Y = A$ in positive logic.

Inputs can be driven from either 3.3-V or 5-V devices. This feature allows the use of these devices as down-translators in a mixed 3.3-V or 5-V system environment.

7.2 Functional Block Diagram

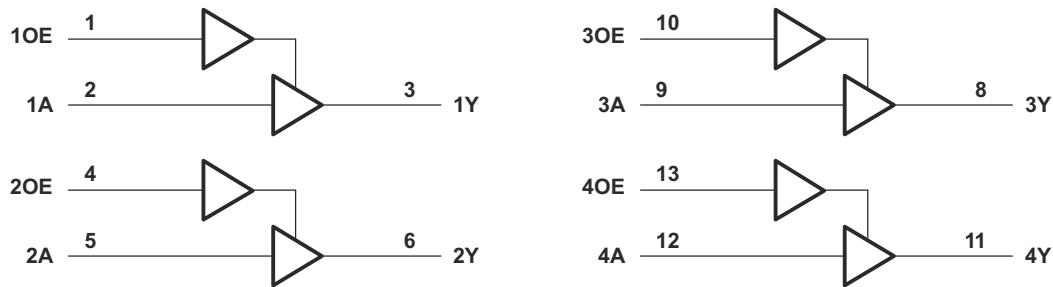

Copyright © 2016, Texas Instruments Incorporated

7.3 Feature Description

The SN74LVC126A device features four independent buffers with 3-state outputs, and is designed to operate from a V_{CC} of 1.65 V to 3.6 V. When the output enable (OE) input is low, the corresponding output is disabled and enters a high-impedance state. This device also features high-tolerance inputs, allowing for voltage translation in mixed voltage systems. Wide operating temperature range enables this device to be used in any application, including rugged or extreme environments.

7.4 Device Functional Modes

The SN74LVC126A's 3-state outputs allow the outputs to be disabled using the output enable (OE) pin. To ensure the high-impedance state during power up and power down, OE must be tied to GND through a pull-down resistor. The minimum value of the resistor is determined by the current-sourcing capability of the driver.

**Table 7-1. Function Table
(Each Buffer)**

INPUTS		OUTPUT
OE	A	Y
H	H	H
H	L	L
L	X	Hi-Z

8 Application and Implementation

Note

Information in the following applications sections is not part of the TI component specification, and TI does not warrant its accuracy or completeness. TI's customers are responsible for determining suitability of components for their purposes. Customers should validate and test their design implementation to confirm system functionality.

8.1 Application Information

The SN74LVC126A device is a high-drive, CMOS device that can be used for a multitude of buffer-type functions. It can produce 24 mA of drive current at 3 V. Therefore, this device is ideal for driving multiple inputs and for high-speed applications up to 100 MHz. The inputs and outputs are 5.5-V tolerant allowing the device to translate up to 5.5 V or down to V_{CC} .

8.2 Typical Application

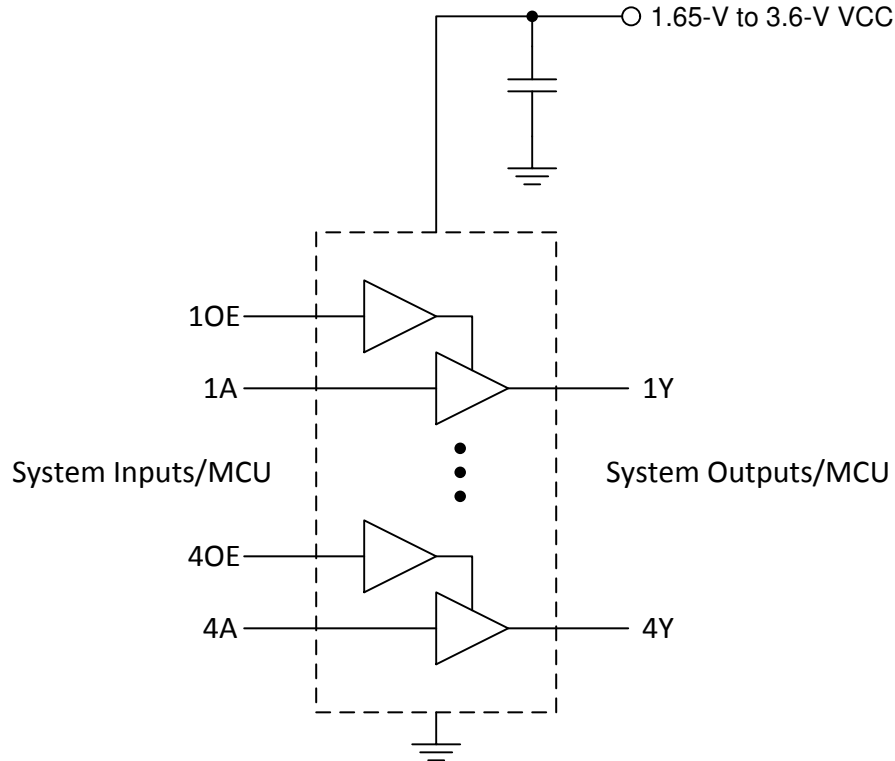

Copyright © 2016, Texas Instruments Incorporated

Figure 8-1. Typical Buffer Application and Supply Voltage

8.2.1 Design Requirements

This device uses CMOS technology and has balanced output drive. Take care to avoid bus contention because it can drive currents that would exceed maximum limits. The high drive also creates fast edges into light loads; therefore, routing and load conditions must be considered to prevent ringing.

8.2.2 Detailed Design Procedure

1. Recommended Input Conditions

- Rise time and fall time specifications: See $(\Delta t/\Delta V)$ in [Recommended Operating Conditions](#).
- Specified high and low levels: See $(V_{IH}$ and $V_{IL})$ in [Recommended Operating Conditions](#).
- Inputs are overvoltage tolerant allowing them to go as high as 5.5 V at any valid V_{CC} .

2. Recommended Output Conditions

- Load currents must not exceed 25 mA per output and 50 mA total for the part.
- Outputs must not be pulled above 5.5 V.

8.2.3 Application Curve

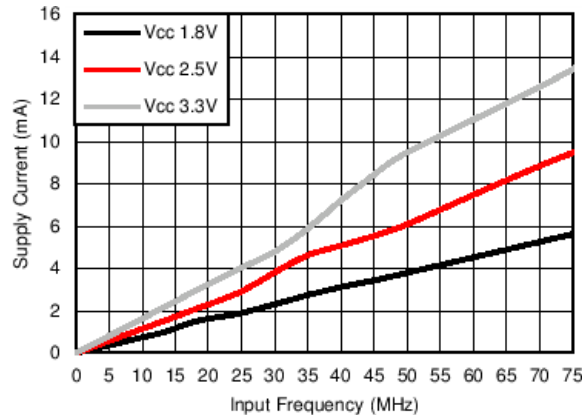

Figure 8-2. Supply Current vs Input Frequency

8.3 Power Supply Recommendations

The power supply can be any voltage between the minimum and maximum supply voltage rating in the [Recommended Operating Conditions](#).

Each V_{CC} pin must have a good bypass capacitor to prevent power disturbance. For devices with a single supply, 0.1 μF is recommended; if there are multiple V_{CC} pins, then 0.01 μF or 0.022 μF is recommended for each power pin. It is acceptable to parallel multiple bypass caps to reject different frequencies of noise. A 0.1 μF and a 1 μF are commonly used in parallel. The bypass capacitor must be installed as close to the power pin as possible for best results.

8.4 Layout

8.4.1 Layout Guidelines

When using multiple bit logic devices, inputs must never float.

In many cases, functions or parts of functions of digital logic devices are unused, for example, when only two inputs of a triple-input and gate are used, or only 3 of the 4 buffer gates are used. Such input pins must not be left unconnected because the undefined voltages at the outside connections result in undefined operational states. [Figure 8-3](#) specifies the rules that must be observed under all circumstances. All unused inputs of digital logic devices must be connected to a high or low bias to prevent them from floating. The logic level that must be applied to any particular unused input depends on the function of the device. Generally they are tied to GND or V_{CC} , whichever makes more sense or is more convenient. It is generally acceptable to float outputs, unless the part is a transceiver.

8.4.2 Layout Example

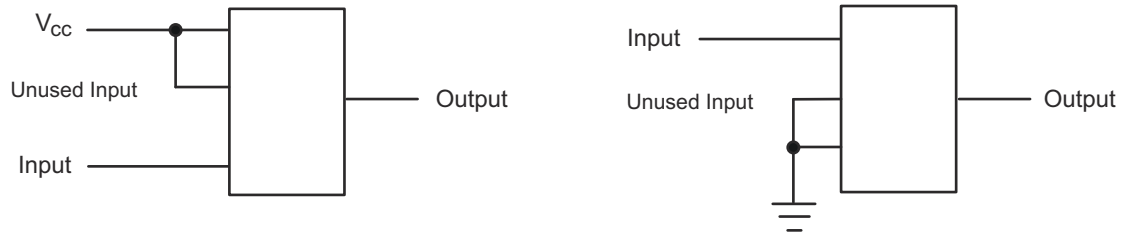

Figure 8-3. Layout Diagram

9 Device and Documentation Support

9.1 Documentation Support

9.1.1 Related Documentation

For related documentation see the following:

TI application report, [Implications of Slow or Floating CMOS Inputs](#) (SCBA004)

9.2 Receiving Notification of Documentation Updates

To receive notification of documentation updates, navigate to the device product folder on [ti.com](#). Click on *Notifications* to register and receive a weekly digest of any product information that has changed. For change details, review the revision history included in any revised document.

9.3 Support Resources

[TI E2E™ support forums](#) are an engineer's go-to source for fast, verified answers and design help — straight from the experts. Search existing answers or ask your own question to get the quick design help you need.

Linked content is provided "AS IS" by the respective contributors. They do not constitute TI specifications and do not necessarily reflect TI's views; see TI's [Terms of Use](#).

9.4 Trademarks

TI E2E™ is a trademark of Texas Instruments.

All trademarks are the property of their respective owners.

9.5 Electrostatic Discharge Caution



This integrated circuit can be damaged by ESD. Texas Instruments recommends that all integrated circuits be handled with appropriate precautions. Failure to observe proper handling and installation procedures can cause damage.

ESD damage can range from subtle performance degradation to complete device failure. Precision integrated circuits may be more susceptible to damage because very small parametric changes could cause the device not to meet its published specifications.

9.6 Glossary

[TI Glossary](#) This glossary lists and explains terms, acronyms, and definitions.

10 Revision History

NOTE: Page numbers for previous revisions may differ from page numbers in the current version.

Changes from Revision T (May 2024) to Revision U (July 2024) Page

- Updated RθJA values: D = 98.4 to 127.8, NS = 93.9 to 123.8, PW = 127.7 to 150.8, RGY = 35 to 92.1; Updated D, NS, PW, and RGY packages for RθJC(top), RθJB, ΨJT, ΨJB, and RθJC(bot), all values in °C/W **5**

Changes from Revision S (February 2017) to Revision T (May 2024) Page

- Updated the numbering format for tables, figures, and cross-references throughout the document..... **1**
- Added BQA package to *Package Information* table, *Pin Configuration and Functions* section, and *Thermal Information* table..... **1**
- Added package size to *Package Information* table..... **1**

11 Mechanical, Packaging, and Orderable Information

The following pages include mechanical, packaging, and orderable information. This information is the most current data available for the designated devices. This data is subject to change without notice and revision of this document. For browser-based versions of this data sheet, refer to the left-hand navigation.

PACKAGING INFORMATION

Orderable Device	Status (1)	Package Type	Package Drawing	Pins	Package Qty	Eco Plan (2)	Lead finish/ Ball material (6)	MSL Peak Temp (3)	Op Temp (°C)	Device Marking (4/5)	Samples
SN74LVC126ABQAR	ACTIVE	WQFN	BQA	14	3000	RoHS & Green	NIPDAU	Level-1-260C-UNLIM	-40 to 125	LV126A	Samples
SN74LVC126AD	ACTIVE	SOIC	D	14	50	RoHS & Green	NIPDAU	Level-1-260C-UNLIM	-40 to 125	LVC126A	Samples
SN74LVC126ADBR	ACTIVE	SSOP	DB	14	2000	RoHS & Green	NIPDAU	Level-1-260C-UNLIM	-40 to 125	LC126A	Samples
SN74LVC126ADGVR	ACTIVE	TVSOP	DGV	14	2000	RoHS & Green	NIPDAU	Level-1-260C-UNLIM	-40 to 125	LC126A	Samples
SN74LVC126ADR	ACTIVE	SOIC	D	14	2500	RoHS & Green	NIPDAU	Level-1-260C-UNLIM	-40 to 125	LVC126A	Samples
SN74LVC126ADRE4	ACTIVE	SOIC	D	14	2500	RoHS & Green	NIPDAU	Level-1-260C-UNLIM	-40 to 125	LVC126A	Samples
SN74LVC126ADRG4	ACTIVE	SOIC	D	14	2500	RoHS & Green	NIPDAU	Level-1-260C-UNLIM	-40 to 125	LVC126A	Samples
SN74LVC126ADT	ACTIVE	SOIC	D	14	250	RoHS & Green	NIPDAU	Level-1-260C-UNLIM	-40 to 125	LVC126A	Samples
SN74LVC126ANSR	ACTIVE	SOP	NS	14	2000	RoHS & Green	NIPDAU	Level-1-260C-UNLIM	-40 to 125	LVC126A	Samples
SN74LVC126APW	ACTIVE	TSSOP	PW	14	90	RoHS & Green	NIPDAU	Level-1-260C-UNLIM	-40 to 125	LC126A	Samples
SN74LVC126APWG4	ACTIVE	TSSOP	PW	14	90	RoHS & Green	NIPDAU	Level-1-260C-UNLIM	-40 to 125	LC126A	Samples
SN74LVC126APWR	ACTIVE	TSSOP	PW	14	2000	RoHS & Green	NIPDAU	Level-1-260C-UNLIM	-40 to 125	LC126A	Samples
SN74LVC126APWRE4	ACTIVE	TSSOP	PW	14	2000	RoHS & Green	NIPDAU	Level-1-260C-UNLIM	-40 to 125	LC126A	Samples
SN74LVC126APWRG4	ACTIVE	TSSOP	PW	14	2000	RoHS & Green	NIPDAU	Level-1-260C-UNLIM	-40 to 125	LC126A	Samples
SN74LVC126APWT	ACTIVE	TSSOP	PW	14	250	RoHS & Green	NIPDAU	Level-1-260C-UNLIM	-40 to 125	LC126A	Samples
SN74LVC126ARGYR	ACTIVE	VQFN	RGY	14	3000	RoHS & Green	NIPDAU	Level-2-260C-1 YEAR	-40 to 125	LC126A	Samples
SN74LVC126ARGYRG4	ACTIVE	VQFN	RGY	14	3000	RoHS & Green	NIPDAU	Level-2-260C-1 YEAR	-40 to 125	LC126A	Samples

(1) The marketing status values are defined as follows:

ACTIVE: Product device recommended for new designs.

LIFEBUY: TI has announced that the device will be discontinued, and a lifetime-buy period is in effect.

NRND: Not recommended for new designs. Device is in production to support existing customers, but TI does not recommend using this part in a new design.

PREVIEW: Device has been announced but is not in production. Samples may or may not be available.

OBSOLETE: TI has discontinued the production of the device.

(2) **RoHS:** TI defines "RoHS" to mean semiconductor products that are compliant with the current EU RoHS requirements for all 10 RoHS substances, including the requirement that RoHS substance do not exceed 0.1% by weight in homogeneous materials. Where designed to be soldered at high temperatures, "RoHS" products are suitable for use in specified lead-free processes. TI may reference these types of products as "Pb-Free".

RoHS Exempt: TI defines "RoHS Exempt" to mean products that contain lead but are compliant with EU RoHS pursuant to a specific EU RoHS exemption.

Green: TI defines "Green" to mean the content of Chlorine (Cl) and Bromine (Br) based flame retardants meet JS709B low halogen requirements of ≤ 1000 ppm threshold. Antimony trioxide based flame retardants must also meet the ≤ 1000 ppm threshold requirement.

(3) MSL, Peak Temp. - The Moisture Sensitivity Level rating according to the JEDEC industry standard classifications, and peak solder temperature.

(4) There may be additional marking, which relates to the logo, the lot trace code information, or the environmental category on the device.

(5) Multiple Device Markings will be inside parentheses. Only one Device Marking contained in parentheses and separated by a "~" will appear on a device. If a line is indented then it is a continuation of the previous line and the two combined represent the entire Device Marking for that device.

(6) Lead finish/Ball material - Orderable Devices may have multiple material finish options. Finish options are separated by a vertical ruled line. Lead finish/Ball material values may wrap to two lines if the finish value exceeds the maximum column width.

Important Information and Disclaimer:The information provided on this page represents TI's knowledge and belief as of the date that it is provided. TI bases its knowledge and belief on information provided by third parties, and makes no representation or warranty as to the accuracy of such information. Efforts are underway to better integrate information from third parties. TI has taken and continues to take reasonable steps to provide representative and accurate information but may not have conducted destructive testing or chemical analysis on incoming materials and chemicals. TI and TI suppliers consider certain information to be proprietary, and thus CAS numbers and other limited information may not be available for release.

In no event shall TI's liability arising out of such information exceed the total purchase price of the TI part(s) at issue in this document sold by TI to Customer on an annual basis.

OTHER QUALIFIED VERSIONS OF SN74LVC126A :

- Automotive : [SN74LVC126A-Q1](#)

NOTE: Qualified Version Definitions:

- Automotive - Q100 devices qualified for high-reliability automotive applications targeting zero defects

TAPE AND REEL INFORMATION

QUADRANT ASSIGNMENTS FOR PIN 1 ORIENTATION IN TAPE

*All dimensions are nominal

Device	Package Type	Package Drawing	Pins	SPQ	Reel Diameter (mm)	Reel Width W1 (mm)	A0 (mm)	B0 (mm)	K0 (mm)	P1 (mm)	W (mm)	Pin1 Quadrant
SN74LVC126ABQAR	WQFN	BQA	14	3000	180.0	12.4	2.8	3.3	1.1	4.0	12.0	Q1
SN74LVC126ADBR	SSOP	DB	14	2000	330.0	16.4	8.35	6.6	2.4	12.0	16.0	Q1
SN74LVC126ADGVR	TVSOP	DGV	14	2000	330.0	12.4	6.8	4.0	1.6	8.0	12.0	Q1
SN74LVC126ADR	SOIC	D	14	2500	330.0	16.4	6.5	9.0	2.1	8.0	16.0	Q1
SN74LVC126ADT	SOIC	D	14	250	330.0	16.4	6.5	9.0	2.1	8.0	16.0	Q1
SN74LVC126ANSR	SOP	NS	14	2000	330.0	16.4	8.2	10.5	2.5	12.0	16.0	Q1
SN74LVC126APWR	TSSOP	PW	14	2000	330.0	12.4	6.9	5.6	1.6	8.0	12.0	Q1
SN74LVC126APWT	TSSOP	PW	14	250	330.0	12.4	6.9	5.6	1.6	8.0	12.0	Q1
SN74LVC126ARGYR	VQFN	RGY	14	3000	330.0	12.4	3.75	3.75	1.15	8.0	12.0	Q1

TAPE AND REEL BOX DIMENSIONS



*All dimensions are nominal

Device	Package Type	Package Drawing	Pins	SPQ	Length (mm)	Width (mm)	Height (mm)
SN74LVC126ABQAR	WQFN	BQA	14	3000	210.0	185.0	35.0
SN74LVC126ADBR	SSOP	DB	14	2000	356.0	356.0	35.0
SN74LVC126ADGVR	TVSOP	DGV	14	2000	356.0	356.0	35.0
SN74LVC126ADR	SOIC	D	14	2500	356.0	356.0	35.0
SN74LVC126ADT	SOIC	D	14	250	210.0	185.0	35.0
SN74LVC126ANSR	SOP	NS	14	2000	356.0	356.0	35.0
SN74LVC126APWR	TSSOP	PW	14	2000	356.0	356.0	35.0
SN74LVC126APWT	TSSOP	PW	14	250	356.0	356.0	35.0
SN74LVC126ARGYR	VQFN	RGY	14	3000	356.0	356.0	35.0

TUBE

*All dimensions are nominal

Device	Package Name	Package Type	Pins	SPQ	L (mm)	W (mm)	T (μm)	B (mm)
SN74LVC126AD	D	SOIC	14	50	506.6	8	3940	4.32
SN74LVC126APW	PW	TSSOP	14	90	530	10.2	3600	3.5
SN74LVC126APWG4	PW	TSSOP	14	90	530	10.2	3600	3.5

GENERIC PACKAGE VIEW

RGY 14

VQFN - 1 mm max height

3.5 x 3.5, 0.5 mm pitch

PLASTIC QUAD FLATPACK - NO LEAD

This image is a representation of the package family, actual package may vary.
Refer to the product data sheet for package details.

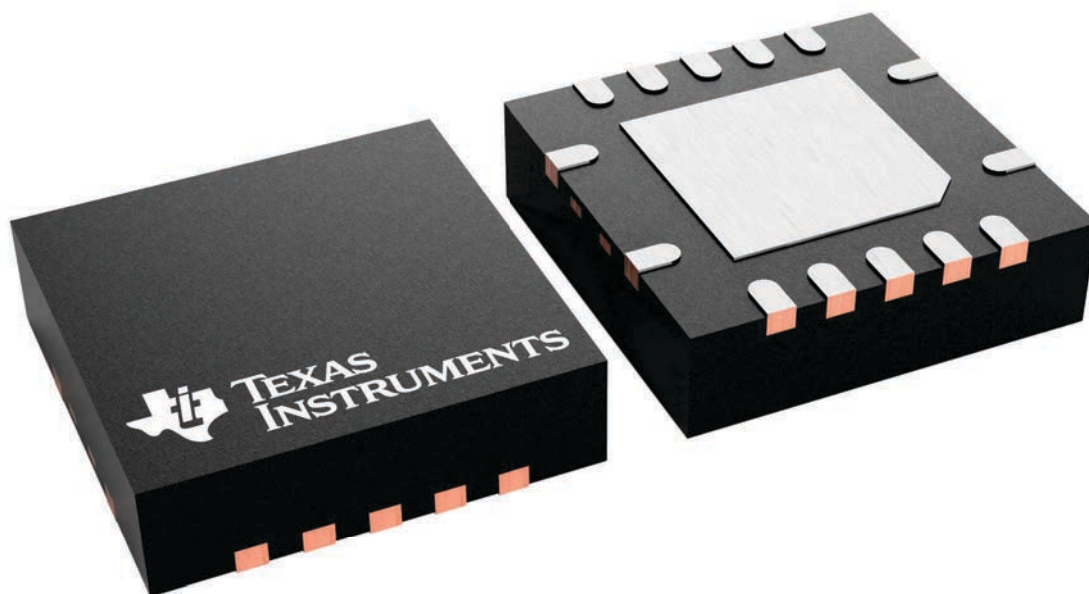

4231541/A

RGY0014A

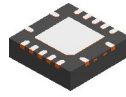

PACKAGE OUTLINE

VQFN - 1 mm max height

PLASTIC QUAD FLATPACK - NO LEAD

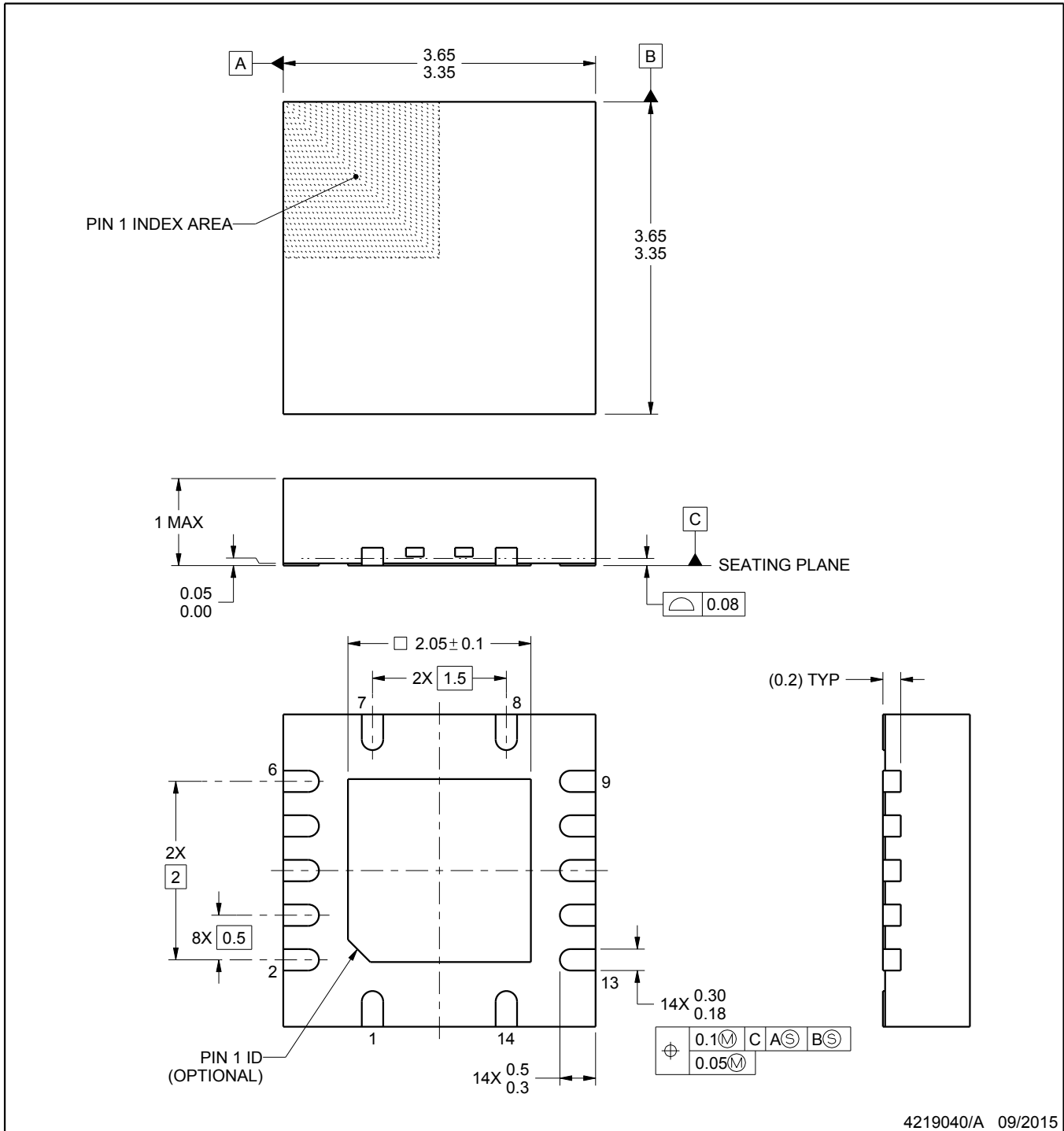

4219040/A 09/2015

NOTES:

1. All linear dimensions are in millimeters. Any dimensions in parenthesis are for reference only. Dimensioning and tolerancing per ASME Y14.5M.
2. This drawing is subject to change without notice.
3. The package thermal pad must be soldered to the printed circuit board for thermal and mechanical performance.

EXAMPLE BOARD LAYOUT

RGY0014A

VQFN - 1 mm max height

PLASTIC QUAD FLATPACK - NO LEAD

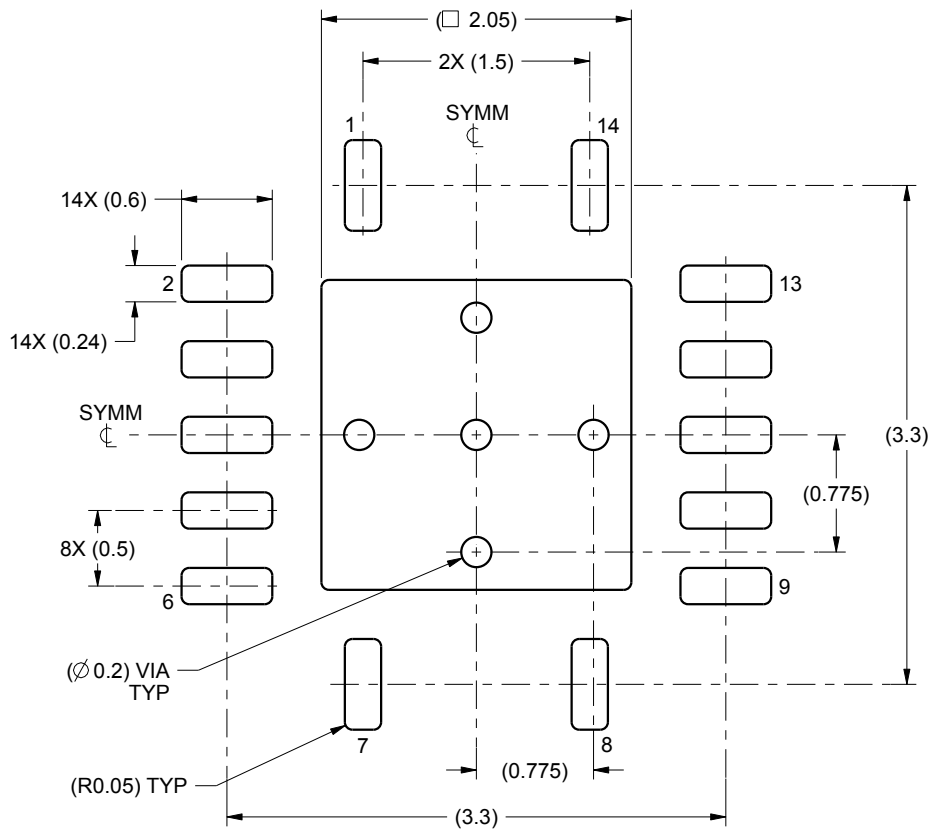

LAND PATTERN EXAMPLE
SCALE:20X

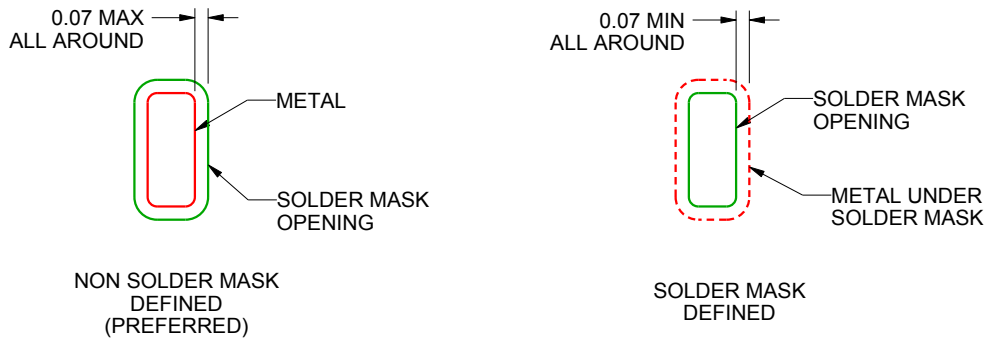

SOLDER MASK DETAILS

4219040/A 09/2015

NOTES: (continued)

4. This package is designed to be soldered to a thermal pad on the board. For more information, see Texas Instruments literature number SLUA271 (www.ti.com/lit/sl原因271).

EXAMPLE STENCIL DESIGN

RGY0014A

VQFN - 1 mm max height

PLASTIC QUAD FLATPACK - NO LEAD

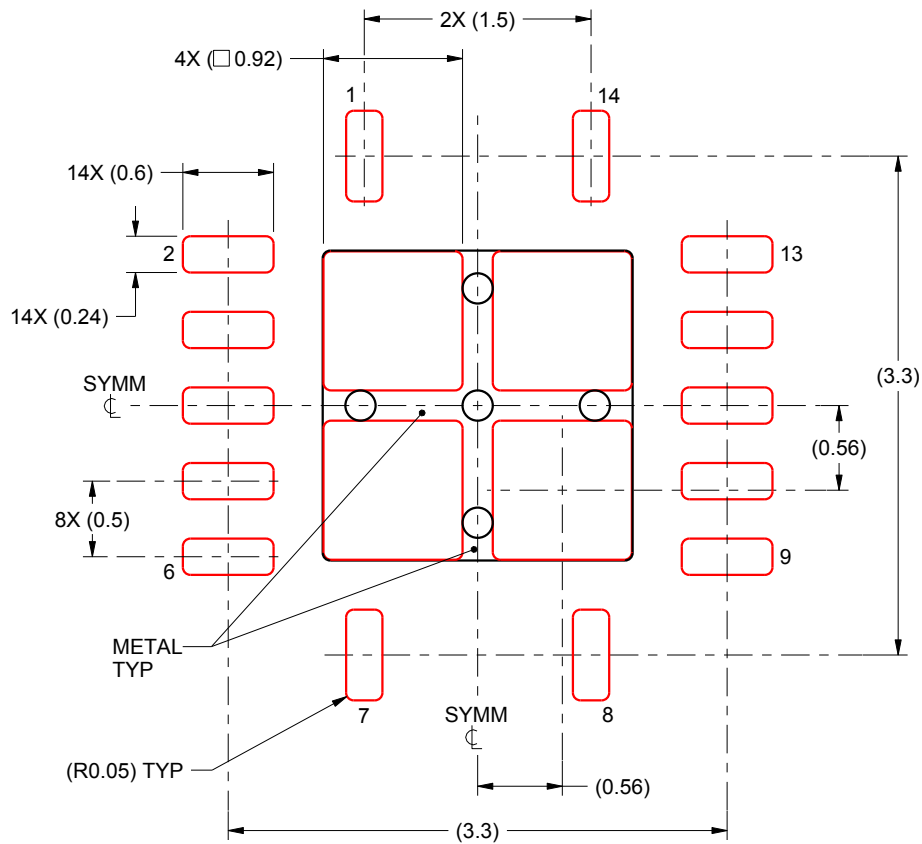

SOLDER PASTE EXAMPLE
BASED ON 0.125 mm THICK STENCIL

EXPOSED PAD
80% PRINTED SOLDER COVERAGE BY AREA
SCALE:20X

4219040/A 09/2015

NOTES: (continued)

5. Laser cutting apertures with trapezoidal walls and rounded corners may offer better paste release. IPC-7525 may have alternate design recommendations.



D0014A

PACKAGE OUTLINE

SOIC - 1.75 mm max height

SMALL OUTLINE INTEGRATED CIRCUIT



4220718/A 09/2016

NOTES:

1. All linear dimensions are in millimeters. Dimensions in parenthesis are for reference only. Dimensioning and tolerancing per ASME Y14.5M.
2. This drawing is subject to change without notice.
3. This dimension does not include mold flash, protrusions, or gate burrs. Mold flash, protrusions, or gate burrs shall not exceed 0.15 mm, per side.
4. This dimension does not include interlead flash. Interlead flash shall not exceed 0.43 mm, per side.
5. Reference JEDEC registration MS-012, variation AB.

EXAMPLE BOARD LAYOUT

D0014A

SOIC - 1.75 mm max height

SMALL OUTLINE INTEGRATED CIRCUIT



LAND PATTERN EXAMPLE
SCALE:8X



SOLDER MASK DETAILS

4220718/A 09/2016

NOTES: (continued)

- 6. Publication IPC-7351 may have alternate designs.
- 7. Solder mask tolerances between and around signal pads can vary based on board fabrication site.

EXAMPLE STENCIL DESIGN

D0014A

SOIC - 1.75 mm max height

SMALL OUTLINE INTEGRATED CIRCUIT



SOLDER PASTE EXAMPLE
BASED ON 0.125 mm THICK STENCIL
SCALE:8X

4220718/A 09/2016

NOTES: (continued)

8. Laser cutting apertures with trapezoidal walls and rounded corners may offer better paste release. IPC-7525 may have alternate design recommendations.
9. Board assembly site may have different recommendations for stencil design.

GENERIC PACKAGE VIEW

BQA 14

WQFN - 0.8 mm max height

2.5 x 3, 0.5 mm pitch

PLASTIC QUAD FLATPACK - NO LEAD

This image is a representation of the package family, actual package may vary.
Refer to the product data sheet for package details.

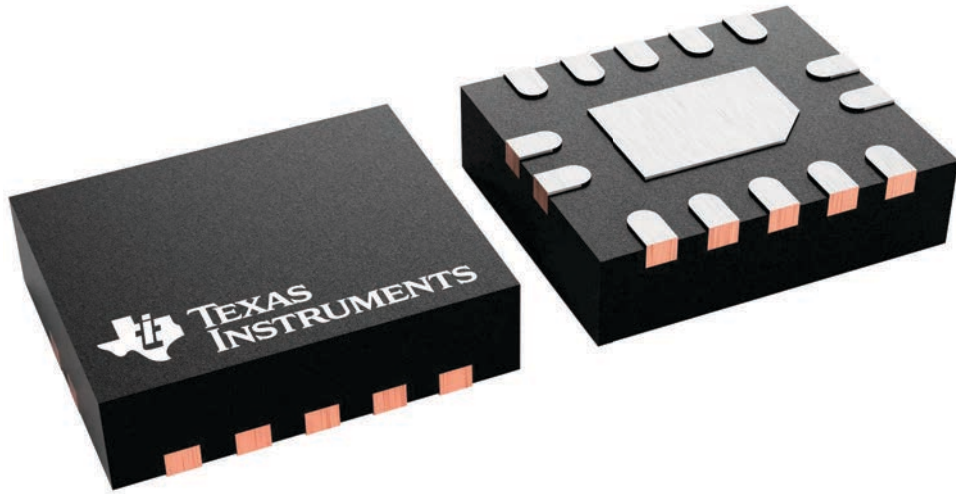

4227145/A

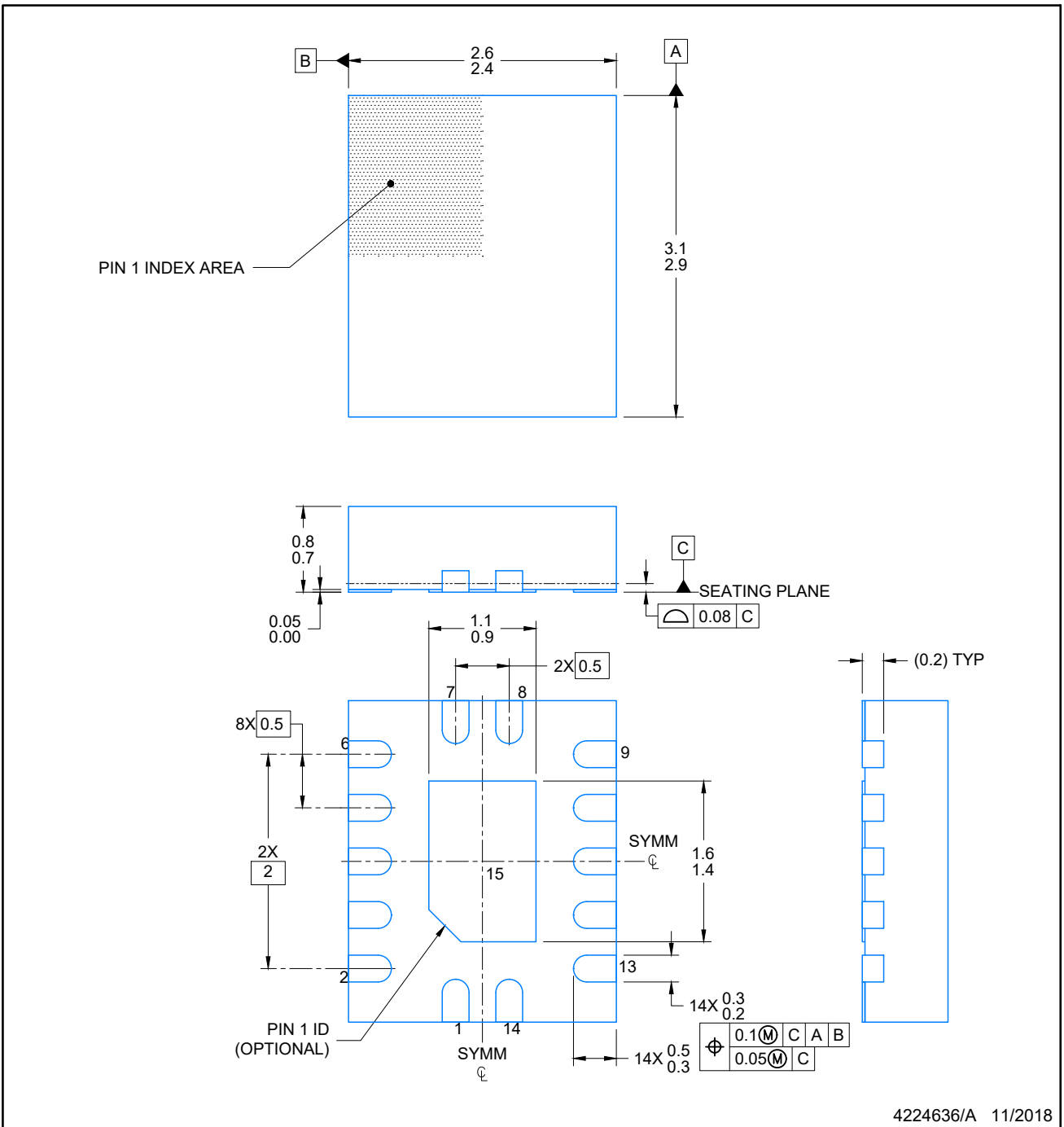

NOTES:

1. All linear dimensions are in millimeters. Any dimensions in parenthesis are for reference only. Dimensioning and tolerancing per ASME Y14.5M.
2. This drawing is subject to change without notice.
3. The package thermal pad must be soldered to the printed circuit board for optimal thermal and mechanical performance.

EXAMPLE BOARD LAYOUT

WQFN - 0.8 mm max height

BQA0014A

PLASTIC QUAD FLAT PACK-NO LEAD



LAND PATTERN EXAMPLE
EXPOSED METAL SHOWN
SCALE: 20X

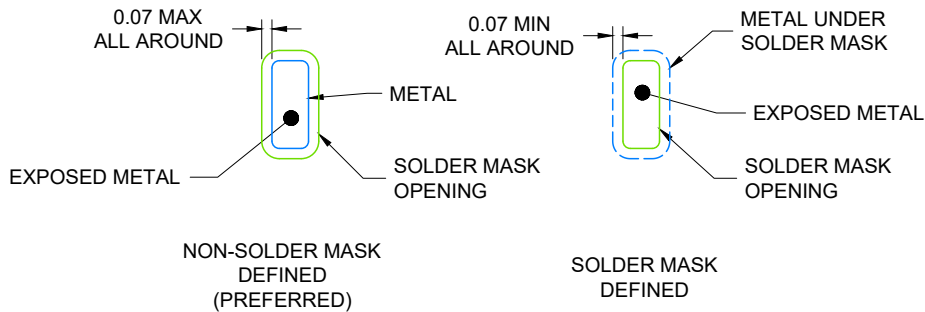

4224636/A 11/2018

NOTES: (continued)

4. This package is designed to be soldered to a thermal pad on the board. For more information, see Texas Instruments literature number SLUA271 (www.ti.com/lit/slua271).
5. Vias are optional depending on application, refer to device data sheet. If any vias are implemented, refer to their locations shown on this view. It is recommended that vias under paste be filled, plugged or tented.

EXAMPLE STENCIL DESIGN

BQA0014A

WQFN - 0.8 mm max height

PLASTIC QUAD FLAT PACK-NO LEAD

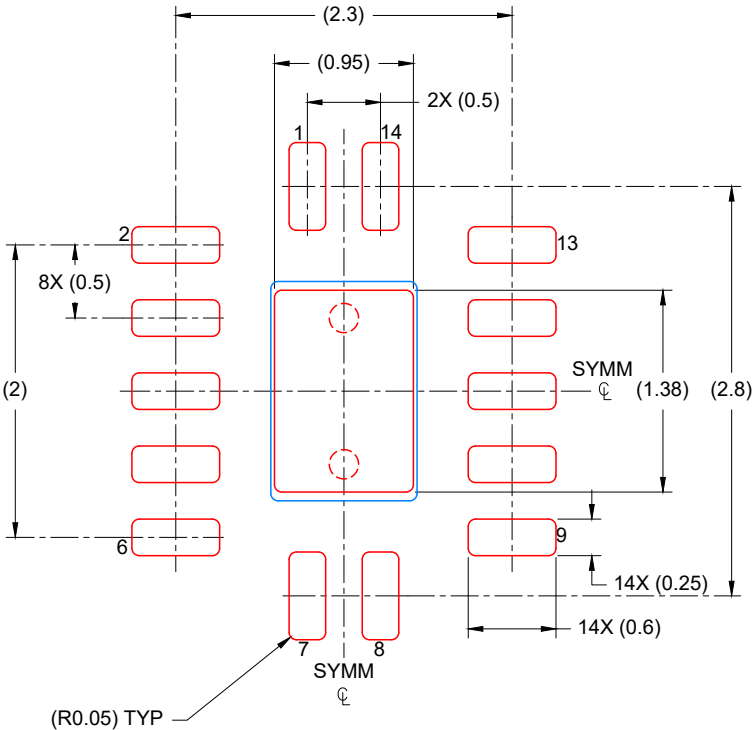

SOLDER PASTE EXAMPLE
BASED ON 0.125 mm THICK STENCIL

EXPOSED PAD
88% PRINTED COVERAGE BY AREA
SCALE: 20X

4224636/A 11/2018

NOTES: (continued)

- 6. Laser cutting apertures with trapezoidal walls and rounded corners may offer better paste release. IPC-7525 may have alternate design recommendations.

MECHANICAL DATA

NS (R-PDSO-G**)

PLASTIC SMALL-OUTLINE PACKAGE

14-PINS SHOWN



- NOTES:
- A. All linear dimensions are in millimeters.
 - B. This drawing is subject to change without notice.
 - C. Body dimensions do not include mold flash or protrusion, not to exceed 0,15.

DB0014A



PACKAGE OUTLINE

SSOP - 2 mm max height

SMALL OUTLINE PACKAGE



4220762/A 05/2024

NOTES:

1. All linear dimensions are in millimeters. Any dimensions in parenthesis are for reference only. Dimensioning and tolerancing per ASME Y14.5M.
2. This drawing is subject to change without notice.
3. This dimension does not include mold flash, protrusions, or gate burrs. Mold flash, protrusions, or gate burrs shall not exceed 0.15 mm per side.
4. Reference JEDEC registration MO-150.

EXAMPLE BOARD LAYOUT

DB0014A

SSOP - 2 mm max height

SMALL OUTLINE PACKAGE



LAND PATTERN EXAMPLE
EXPOSED METAL SHOWN
SCALE: 10X



4220762/A 05/2024

NOTES: (continued)

- 5. Publication IPC-7351 may have alternate designs.
- 6. Solder mask tolerances between and around signal pads can vary based on board fabrication site.

EXAMPLE STENCIL DESIGN

DB0014A

SSOP - 2 mm max height

SMALL OUTLINE PACKAGE



SOLDER PASTE EXAMPLE
BASED ON 0.125 mm THICK STENCIL
SCALE: 10X

4220762/A 05/2024

NOTES: (continued)

7. Laser cutting apertures with trapezoidal walls and rounded corners may offer better paste release. IPC-7525 may have alternate design recommendations.
8. Board assembly site may have different recommendations for stencil design.

PW0014A



PACKAGE OUTLINE
TSSOP - 1.2 mm max height

SMALL OUTLINE PACKAGE



4220202/B 12/2023

NOTES:

1. All linear dimensions are in millimeters. Any dimensions in parenthesis are for reference only. Dimensioning and tolerancing per ASME Y14.5M.
2. This drawing is subject to change without notice.
3. This dimension does not include mold flash, protrusions, or gate burrs. Mold flash, protrusions, or gate burrs shall not exceed 0.15 mm per side.
4. This dimension does not include interlead flash. Interlead flash shall not exceed 0.25 mm per side.
5. Reference JEDEC registration MO-153.

EXAMPLE BOARD LAYOUT

PW0014A

TSSOP - 1.2 mm max height

SMALL OUTLINE PACKAGE



LAND PATTERN EXAMPLE
EXPOSED METAL SHOWN
SCALE: 10X



4220202/B 12/2023

NOTES: (continued)

- 6. Publication IPC-7351 may have alternate designs.
- 7. Solder mask tolerances between and around signal pads can vary based on board fabrication site.

EXAMPLE STENCIL DESIGN

PW0014A

TSSOP - 1.2 mm max height

SMALL OUTLINE PACKAGE



SOLDER PASTE EXAMPLE
BASED ON 0.125 mm THICK STENCIL
SCALE: 10X

4220202/B 12/2023

NOTES: (continued)

8. Laser cutting apertures with trapezoidal walls and rounded corners may offer better paste release. IPC-7525 may have alternate design recommendations.
9. Board assembly site may have different recommendations for stencil design.

IMPORTANT NOTICE AND DISCLAIMER

TI PROVIDES TECHNICAL AND RELIABILITY DATA (INCLUDING DATA SHEETS), DESIGN RESOURCES (INCLUDING REFERENCE DESIGNS), APPLICATION OR OTHER DESIGN ADVICE, WEB TOOLS, SAFETY INFORMATION, AND OTHER RESOURCES "AS IS" AND WITH ALL FAULTS, AND DISCLAIMS ALL WARRANTIES, EXPRESS AND IMPLIED, INCLUDING WITHOUT LIMITATION ANY IMPLIED WARRANTIES OF MERCHANTABILITY, FITNESS FOR A PARTICULAR PURPOSE OR NON-INFRINGEMENT OF THIRD PARTY INTELLECTUAL PROPERTY RIGHTS.

These resources are intended for skilled developers designing with TI products. You are solely responsible for (1) selecting the appropriate TI products for your application, (2) designing, validating and testing your application, and (3) ensuring your application meets applicable standards, and any other safety, security, regulatory or other requirements.

These resources are subject to change without notice. TI grants you permission to use these resources only for development of an application that uses the TI products described in the resource. Other reproduction and display of these resources is prohibited. No license is granted to any other TI intellectual property right or to any third party intellectual property right. TI disclaims responsibility for, and you will fully indemnify TI and its representatives against, any claims, damages, costs, losses, and liabilities arising out of your use of these resources.

TI's products are provided subject to [TI's Terms of Sale](#) or other applicable terms available either on [ti.com](https://www.ti.com) or provided in conjunction with such TI products. TI's provision of these resources does not expand or otherwise alter TI's applicable warranties or warranty disclaimers for TI products.

TI objects to and rejects any additional or different terms you may have proposed.

Mailing Address: Texas Instruments, Post Office Box 655303, Dallas, Texas 75265
Copyright © 2025, Texas Instruments Incorporated