

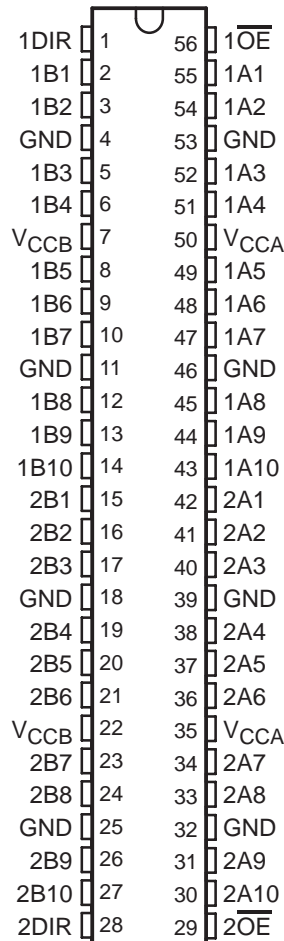
# SN74AVC20T245

## 20-BIT DUAL-SUPPLY BUS TRANSCEIVER WITH CONFIGURABLE VOLTAGE TRANSLATION AND 3-STATE OUTPUTS

SCE5566F – MAY 2004 – REVISED APRIL 2005

- Control Inputs  $V_{IH}/V_{IL}$  Levels are Referenced to  $V_{CCA}$  Voltage
- $V_{CC}$  Isolation Feature – If Either  $V_{CC}$  Input Is at GND, Both Ports Are in the High-Impedance State
- Overvoltage-Tolerant Inputs/Outputs Allow Mixed-Voltage-Mode Data Communications
- Fully Configurable Dual-Rail Design Allows Each Port to Operate Over the Full 1.2-V to 3.6-V Power-Supply Range
- $I_{off}$  Supports Partial-Power-Down Mode Operation
- I/Os Are 4.6-V Tolerant
- Max Data Rates
  - 380 Mbps (1.8-V to 3.3-V Translation)
  - 260 Mbps (< 1.8-V to 3.3-V Translation)
  - 260 Mbps (Translate to 2.5 V)
  - 210 Mbps (Translate to 1.8 V)
  - 120 Mbps (Translate to 1.5 V)
  - 100 Mbps (Translate to 1.2 V)
- Latch-Up Performance Exceeds 100 mA Per JESD 78, Class II
- ESD Protection Exceeds JESD 22
  - 8000-V Human-Body Model (A114-A)
  - 200-V Machine Model (A115-A)
  - 1000-V Charged-Device Model (C101)

DGG OR DGV PACKAGE  
(TOP VIEW)



### description/ordering information

This 20-bit noninverting bus transceiver uses two separate configurable power-supply rails.

The SN74AVC20T245 is optimized to operate with  $V_{CCA}/V_{CCB}$  set at 1.4 V to 3.6 V. It is operational with  $V_{CCA}/V_{CCB}$  as low as 1.2 V. The A port is designed to track  $V_{CCA}$ .  $V_{CCA}$  accepts any supply voltage from 1.2 V to 3.6 V. The B port is designed to track  $V_{CCB}$ .  $V_{CCB}$  accepts any supply voltage from 1.2 V to 3.6 V. This allows for universal low-voltage bidirectional translation between any of the 1.2-V, 1.5-V, 1.8-V, 2.5-V, and 3.3-V voltage nodes.

### ORDERING INFORMATION

$T_A$	PACKAGE†		ORDERABLE PART NUMBER	TOP-SIDE MARKING
–40°C to 85°C	TSSOP – DGG	Tape and reel	SN74AVC20T245DGGR	AVC20T245
	TVSOP – DGV	Tape and reel	SN74AVC20T245DGVR	WG245
	VFBGA – GQL	Tape and reel	SN74AVC20T245GQLR	WG245
	VFBGA – ZQL (Pb-free)		SN74AVC20T245ZQLR	

† Package drawings, standard packing quantities, thermal data, symbolization, and PCB design guidelines are available at [www.ti.com/sc/package](http://www.ti.com/sc/package).



Please be aware that an important notice concerning availability, standard warranty, and use in critical applications of Texas Instruments semiconductor products and disclaimers thereto appears at the end of this data sheet.

PRODUCTION DATA information is current as of publication date. Products conform to specifications per the terms of Texas Instruments standard warranty. Production processing does not necessarily include testing of all parameters.



POST OFFICE BOX 655303 • DALLAS, TEXAS 75265

Copyright © 2005, Texas Instruments Incorporated

# SN74AVC20T245

## 20-BIT DUAL-SUPPLY BUS TRANSCEIVER

### WITH CONFIGURABLE VOLTAGE TRANSLATION AND 3-STATE OUTPUTS

SCES566F – MAY 2004 – REVISED APRIL 2005

#### description/ordering information (continued)

The SN74AVC20T245 is designed for asynchronous communication between data buses. The device transmits data from the A bus to the B bus or from the B bus to the A bus, depending on the logic level at the direction-control (DIR) input. The output-enable ( $\overline{OE}$ ) input is used to disable the outputs so that the buses are isolated.

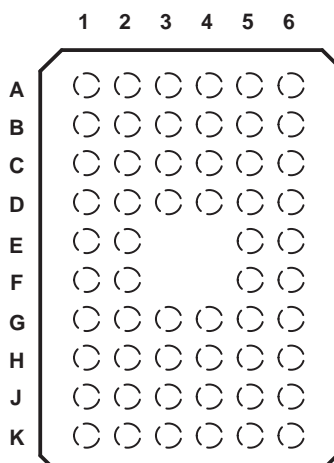
The SN74AVC20T245 is designed so that the control (1DIR, 2DIR,  $1\overline{OE}$ , and  $2\overline{OE}$ ) inputs are supplied by  $V_{CCA}$ .

This device is fully specified for partial-power-down applications using  $I_{off}$ . The  $I_{off}$  circuitry disables the outputs, preventing damaging current backflow through the device when it is powered down.

The  $V_{CC}$  isolation feature ensures that if either  $V_{CC}$  input is at GND, both ports are in the high-impedance state.

To ensure the high-impedance state during power up or power down,  $\overline{OE}$  should be tied to  $V_{CC}$  through a pullup resistor; the minimum value of the resistor is determined by the current-sinking capability of the driver.

#### GQL OR ZQL PACKAGE (TOP VIEW)



#### terminal assignments

	1	2	3	4	5	6
A	1B1	1B2	1DIR	$1\overline{OE}$	1A2	1A1
B	1B3	1B4	GND	GND	1A4	1A3
C	1B5	1B6	$V_{CCB}$	$V_{CCA}$	1A6	1A5
D	1B7	1B8	GND	GND	1A8	1A7
E	1B9	1B10			1A10	1A9
F	2B1	2B2			2A2	2A1
G	2B3	2B4	GND	GND	2A4	2A3
H	2B5	2B6	$V_{CCB}$	$V_{CCA}$	2A6	2A5
J	2B7	2B8	GND	GND	2A8	2A7
K	2B9	2B10	2DIR	$2\overline{OE}$	2A10	2A9

#### FUNCTION TABLE (each 10-bit section)

INPUTS		OPERATION
$\overline{OE}$	DIR	
L	L	B data to A bus
L	H	A data to B bus
H	X	Isolation



# SN74AVC20T245

## 20-BIT DUAL-SUPPLY BUS TRANSCEIVER

### WITH CONFIGURABLE VOLTAGE TRANSLATION AND 3-STATE OUTPUTS

SCES566F – MAY 2004 – REVISED APRIL 2005

#### recommended operating conditions (see Notes 4 through 8)

		V <sub>CCI</sub>	V <sub>CCO</sub>	MIN	MAX	UNIT
V <sub>CCA</sub>	Supply voltage			1.2	3.6	V
V <sub>CCB</sub>	Supply voltage			1.2	3.6	V
V <sub>IH</sub>	High-level input voltage	Data inputs (see Note 7)	1.2 V to 1.95 V	V <sub>CCI</sub> × 0.65		V
			1.95 V to 2.7 V	1.6		
			2.7 V to 3.6 V	2		
V <sub>IL</sub>	Low-level input voltage	Data inputs (see Note 7)	1.2 V to 1.95 V	V <sub>CCI</sub> × 0.35		V
			1.95 V to 2.7 V	0.7		
			2.7 V to 3.6 V	0.8		
V <sub>IH</sub>	High-level input voltage	DIR (referenced to V <sub>CCA</sub> ) (see Note 8)	1.2 V to 1.95 V	V <sub>CCA</sub> × 0.65		V
			1.95 V to 2.7 V	1.6		
			2.7 V to 3.6 V	2		
V <sub>IL</sub>	Low-level input voltage	DIR (referenced to V <sub>CCA</sub> ) (see Note 8)	1.2 V to 1.95 V	V <sub>CCA</sub> × 0.35		V
			1.95 V to 2.7 V	0.7		
			2.7 V to 3.6 V	0.8		
V <sub>I</sub>	Input voltage			0	3.6	V
V <sub>O</sub>	Output voltage	Active state		0	V <sub>CCO</sub>	V
		3-state		0	3.6	V
I <sub>OH</sub>	High-level output current		1.2 V	-3		mA
			1.4 V to 1.6 V	-6		
			1.65 V to 1.95 V	-8		
			2.3 V to 2.7 V	-9		
			3 V to 3.6 V	-12		
I <sub>OL</sub>	Low-level output current		1.2 V	3		mA
			1.4 V to 1.6 V	6		
			1.65 V to 1.95 V	8		
			2.3 V to 2.7 V	9		
			3 V to 3.6 V	12		
Δt/Δv	Input transition rise or fall rate				5	ns/V
T <sub>A</sub>	Operating free-air temperature			-40	85	°C

- NOTES:
- V<sub>CCI</sub> is the V<sub>CC</sub> associated with the data input port.
  - V<sub>CCO</sub> is the V<sub>CC</sub> associated with the output port.
  - All unused data inputs of the device must be held at V<sub>CCI</sub> or GND to ensure proper device operation. Refer to the TI application report, *Implications of Slow or Floating CMOS Inputs*, literature number SCBA004.
  - For V<sub>CCI</sub> values not specified in the data sheet, V<sub>IH(min)</sub> = V<sub>CCI</sub> × 0.7 V, V<sub>IL(max)</sub> = V<sub>CCI</sub> × 0.3 V.
  - For V<sub>CCI</sub> values not specified in the data sheet, V<sub>IH(min)</sub> = V<sub>CCA</sub> × 0.7 V, V<sub>IL(max)</sub> = V<sub>CCA</sub> × 0.3 V.



**SN74AVC20T245**  
**20-BIT DUAL-SUPPLY BUS TRANSCEIVER**  
**WITH CONFIGURABLE VOLTAGE TRANSLATION AND 3-STATE OUTPUTS**

SCE5566F – MAY 2004 – REVISED APRIL 2005

electrical characteristics over recommended operating free-air temperature range (unless otherwise noted) (see Notes 9 and 10)

PARAMETER	TEST CONDITIONS		V <sub>CCA</sub>	V <sub>CCB</sub>	T <sub>A</sub> = 25°C			-40°C to 85°C		UNIT
					MIN	TYP	MAX	MIN	MAX	
V <sub>OH</sub>		V <sub>I</sub> = V <sub>IH</sub>	1.2 V to 3.6 V	1.2 V to 3.6 V				V <sub>CCO</sub> - 0.2 V		V
			1.2 V	1.2 V	0.95					
			1.4 V	1.4 V				1.05		
			1.65 V	1.65 V				1.2		
			2.3 V	2.3 V				1.75		
			3 V	3 V				2.3		
V <sub>OL</sub>		V <sub>I</sub> = V <sub>IL</sub>	1.2 V to 3.6 V	1.2 V to 3.6 V				0.2		V
			1.2 V	1.2 V	0.15					
			1.4 V	1.4 V				0.35		
			1.65 V	1.65 V				0.45		
			2.3 V	2.3 V				0.55		
			3 V	3 V				0.7		
I <sub>I</sub>	Control inputs	V <sub>I</sub> = V <sub>CCA</sub> or GND	1.2 V to 3.6 V	1.2 V to 3.6 V	±0.025	±0.25		±1	μA	
I <sub>off</sub>	A or B port	V <sub>I</sub> or V <sub>O</sub> = 0 to 3.6 V	0 V	0 to 3.6 V	±0.1	±1		±5	μA	
	A or B port		0 to 3.6 V	0 V	±0.1	±1		±5		
I <sub>OZ</sub> †	A or B ports	V <sub>O</sub> = V <sub>CCO</sub> or GND, V <sub>I</sub> = V <sub>CCI</sub> or GND, $\overline{OE}$ = V <sub>IH</sub>	3.6 V	3.6 V	±0.5	±2.5		±5	μA	
I <sub>CCA</sub>		V <sub>I</sub> = V <sub>CCI</sub> or GND, I <sub>O</sub> = 0	1.2 V to 3.6 V	1.2 V to 3.6 V				35	μA	
			0 V	3.6 V				-5		
			3.6 V	0 V				35		
I <sub>CCB</sub>		V <sub>I</sub> = V <sub>CCI</sub> or GND, I <sub>O</sub> = 0	1.2 V to 3.6 V	1.2 V to 3.6 V				35	μA	
			0 V	3.6 V				35		
			3.6 V	0 V				-5		
I <sub>CCA</sub> + I <sub>CCB</sub>		V <sub>I</sub> = V <sub>CCI</sub> or GND, I <sub>O</sub> = 0	1.2 V to 3.6 V	1.2 V to 3.6 V				65	μA	
C <sub>i</sub>	Control inputs	V <sub>I</sub> = 3.3 V or GND	3.3 V	3.3 V	3.5				pF	
C <sub>io</sub>	A or B ports	V <sub>O</sub> = 3.3 V or GND	3.3 V	3.3 V	7				pF	

† For I/O ports, the parameter I<sub>OZ</sub> includes the input leakage current.

NOTES: 9. V<sub>CCO</sub> is the V<sub>CC</sub> associated with the output port.

10. V<sub>CCI</sub> is the V<sub>CC</sub> associated with the input port.



**SN74AVC20T245**  
**20-BIT DUAL-SUPPLY BUS TRANSCEIVER**  
**WITH CONFIGURABLE VOLTAGE TRANSLATION AND 3-STATE OUTPUTS**

SCES566F – MAY 2004 – REVISED APRIL 2005

switching characteristics over recommended operating free-air temperature range,  
**V<sub>CCA</sub> = 1.2 V** (see Figure 1)

PARAMETER	FROM (INPUT)	TO (OUTPUT)	V <sub>CCB</sub> = 1.2 V	V <sub>CCB</sub> = 1.5 V	V <sub>CCB</sub> = 1.8 V	V <sub>CCB</sub> = 2.5 V	V <sub>CCB</sub> = 3.3 V	UNIT
			TYP	TYP	TYP	TYP	TYP	
t <sub>PLH</sub>	A	B	3.8	3.1	2.8	2.7	3.3	ns
t <sub>PHL</sub>			3.8	3.1	2.8	2.7	3.3	
t <sub>PLH</sub>	B	A	4.1	3.8	3.6	3.5	3.4	ns
t <sub>PHL</sub>			4.1	3.8	3.6	3.5	3.4	
t <sub>PZH</sub>	$\overline{OE}$	A	6.5	6.5	6.5	6.5	6.5	ns
t <sub>PZL</sub>			6.5	6.5	6.5	6.5	6.5	
t <sub>PZH</sub>	$\overline{OE}$	B	5.6	4.4	3.8	3.3	3.2	ns
t <sub>PZL</sub>			5.6	4.4	3.8	3.3	3.2	
t <sub>PHZ</sub>	$\overline{OE}$	A	6.4	6.4	6.4	6.4	6.4	ns
t <sub>PLZ</sub>			6.4	6.4	6.4	6.4	6.4	
t <sub>PHZ</sub>	$\overline{OE}$	B	5.7	4.6	4.7	4.1	5.4	ns
t <sub>PLZ</sub>			5.7	4.6	4.7	4.1	5.4	

switching characteristics over recommended operating free-air temperature range,  
**V<sub>CCA</sub> = 1.5 V ± 0.1 V** (see Figure 1)

PARAMETER	FROM (INPUT)	TO (OUTPUT)	V <sub>CCB</sub> = 1.2 V	V <sub>CCB</sub> = 1.5 V ± 0.1 V		V <sub>CCB</sub> = 1.8 V ± 0.15 V		V <sub>CCB</sub> = 2.5 V ± 0.2 V		V <sub>CCB</sub> = 3.3 V ± 0.3 V		UNIT
			TYP	MIN	MAX	MIN	MAX	MIN	MAX	MIN	MAX	
t <sub>PLH</sub>	A	B	3.8	0.5	6.4	0.5	5.4	0.5	4.3	0.5	3.9	ns
t <sub>PHL</sub>			3.8	0.5	6.4	0.5	5.4	0.5	4.3	0.5	3.9	
t <sub>PLH</sub>	B	A	3.1	0.5	6.4	0.5	6.1	0.5	5.8	0.5	5.7	ns
t <sub>PHL</sub>			3.1	0.5	6.4	0.5	6.1	0.5	5.8	0.5	5.7	
t <sub>PZH</sub>	$\overline{OE}$	A	4.3	1.5	10.3	1.5	10.3	1.5	10.2	1.5	10.2	ns
t <sub>PZL</sub>			4.3	1.5	10.3	1.5	10.3	1.5	10.2	1.5	10.2	
t <sub>PZH</sub>	$\overline{OE}$	B	5.2	1	10.3	1	8.4	0.5	6.1	0.5	5.3	ns
t <sub>PZL</sub>			5.2	1	10.3	1	8.4	0.5	6.1	0.5	5.3	
t <sub>PHZ</sub>	$\overline{OE}$	A	4.5	2	9	2	9	2	9	2	9	ns
t <sub>PLZ</sub>			4.5	2	9	2	9	2	9	2	9	
t <sub>PHZ</sub>	$\overline{OE}$	B	5.1	1.5	9	1.5	7.8	1	6.4	1	5.9	ns
t <sub>PLZ</sub>			5.1	1.5	9	1.5	7.8	1	6.4	1	5.9	



**SN74AVC20T245**  
**20-BIT DUAL-SUPPLY BUS TRANSCEIVER**  
**WITH CONFIGURABLE VOLTAGE TRANSLATION AND 3-STATE OUTPUTS**

SCES566F – MAY 2004 – REVISED APRIL 2005

switching characteristics over recommended operating free-air temperature range,  
 $V_{CCA} = 1.8\text{ V} \pm 0.15\text{ V}$  (see Figure 1)

PARAMETER	FROM (INPUT)	TO (OUTPUT)	$V_{CCB} = 1.2\text{ V}$	$V_{CCB} = 1.5\text{ V} \pm 0.1\text{ V}$		$V_{CCB} = 1.8\text{ V} \pm 0.15\text{ V}$		$V_{CCB} = 2.5\text{ V} \pm 0.2\text{ V}$		$V_{CCB} = 3.3\text{ V} \pm 0.3\text{ V}$		UNIT
			TYP	MIN	MAX	MIN	MAX	MIN	MAX	MIN	MAX	
$t_{PLH}$	A	B	3.6	0.5	6.1	0.5	5	0.5	3.9	0.5	3.5	ns
$t_{PHL}$			3.6	0.5	6.1	0.5	5	0.5	3.9	0.5	3.5	
$t_{PLH}$	B	A	2.8	0.5	5.4	0.5	5	0.5	4.7	0.5	4.6	ns
$t_{PHL}$			2.8	0.5	5.4	0.5	5	0.5	4.7	0.5	4.6	
$t_{PZH}$	$\overline{OE}$	A	3.4	1	8.1	1	7.9	1	7.9	1	7.9	ns
$t_{PZL}$			3.4	1	8.1	1	7.9	1	7.9	1	7.9	
$t_{PZH}$	$\overline{OE}$	B	5	0.5	10	0.5	7.9	0.5	5.7	0.5	4.8	ns
$t_{PZL}$			5	0.5	10	0.5	7.9	0.5	5.7	0.5	4.8	
$t_{PHZ}$	$\overline{OE}$	A	4.1	2	7.4	2	7.4	2	7.4	2	7.4	ns
$t_{PLZ}$			4.1	2	7.4	2	7.4	2	7.4	2	7.4	
$t_{PHZ}$	$\overline{OE}$	B	4.9	1.5	8.7	1.5	7.4	1	5.8	1	5.1	ns
$t_{PLZ}$			4.9	1.5	8.7	1.5	7.4	1	5.8	1	5.1	

switching characteristics over recommended operating free-air temperature range,  
 $V_{CCA} = 2.5\text{ V} \pm 0.2\text{ V}$  (see Figure 1)

PARAMETER	FROM (INPUT)	TO (OUTPUT)	$V_{CCB} = 1.2\text{ V}$	$V_{CCB} = 1.5\text{ V} \pm 0.1\text{ V}$		$V_{CCB} = 1.8\text{ V} \pm 0.15\text{ V}$		$V_{CCB} = 2.5\text{ V} \pm 0.2\text{ V}$		$V_{CCB} = 3.3\text{ V} \pm 0.3\text{ V}$		UNIT
			TYP	MIN	MAX	MIN	MAX	MIN	MAX	MIN	MAX	
$t_{PLH}$	A	B	3.5	0.5	5.8	0.5	4.7	0.5	3.5	0.5	3	ns
$t_{PHL}$			3.5	0.5	5.8	0.5	4.7	0.5	3.5	0.5	3	
$t_{PLH}$	B	A	2.7	0.5	4.3	0.5	3.9	0.5	3.5	0.5	3.4	ns
$t_{PHL}$			2.7	0.5	4.3	0.5	3.9	0.5	3.5	0.5	3.4	
$t_{PZH}$	$\overline{OE}$	A	2.5	0.5	5.4	0.5	5.3	0.5	5.2	0.5	5.2	ns
$t_{PZL}$			2.5	0.5	5.4	0.5	5.3	0.5	5.2	0.5	5.2	
$t_{PZH}$	$\overline{OE}$	B	4.8	0.5	9.6	0.5	7.6	0.5	5.3	0.5	4.3	ns
$t_{PZL}$			4.8	0.5	9.6	0.5	7.6	0.5	5.3	0.5	4.3	
$t_{PHZ}$	$\overline{OE}$	A	3	1.1	5.2	1.1	5.2	1.1	5.2	1.1	5.2	ns
$t_{PLZ}$			3	1.1	5.2	1.1	5.2	1.1	5.2	1.1	5.2	
$t_{PHZ}$	$\overline{OE}$	B	4.7	1.2	8.2	1.2	6.9	1	5.3	1	5	ns
$t_{PLZ}$			4.7	1.2	8.2	1.2	6.9	1	5.3	1	5	

# SN74AVC20T245

## 20-BIT DUAL-SUPPLY BUS TRANSCEIVER

### WITH CONFIGURABLE VOLTAGE TRANSLATION AND 3-STATE OUTPUTS

SCES566F – MAY 2004 – REVISED APRIL 2005

switching characteristics over recommended operating free-air temperature range,  
 $V_{CCA} = 3.3 \text{ V} \pm 0.3 \text{ V}$  (see Figure 1)

PARAMETER	FROM (INPUT)	TO (OUTPUT)	$V_{CCB} = 1.2 \text{ V}$	$V_{CCB} = 1.5 \text{ V} \pm 0.1 \text{ V}$		$V_{CCB} = 1.8 \text{ V} \pm 0.15 \text{ V}$		$V_{CCB} = 2.5 \text{ V} \pm 0.2 \text{ V}$		$V_{CCB} = 3.3 \text{ V} \pm 0.3 \text{ V}$		UNIT
			TYP	MIN	MAX	MIN	MAX	MIN	MAX	MIN	MAX	
$t_{PLH}$	A	B	3.4	0.5	5.7	0.5	4.6	0.5	3.4	0.5	2.9	ns
$t_{PHL}$			3.4	0.5	5.7	0.5	4.6	0.5	3.4	0.5	2.9	
$t_{PLH}$	B	A	3.3	0.5	3.9	0.5	3.5	0.5	3	0.5	2.9	ns
$t_{PHL}$			3.3	0.5	3.9	0.5	3.5	0.5	3	0.5	2.9	
$t_{PZH}$	$\overline{OE}$	A	2.2	0.5	4.4	0.5	4.3	0.5	4.2	0.5	4.1	ns
$t_{PZL}$			2.2	0.5	4.4	0.5	4.3	0.5	4.2	0.5	4.1	
$t_{PZH}$	$\overline{OE}$	B	4.7	1	9.6	0.5	7.5	0.5	5.1	0.5	4.1	ns
$t_{PZL}$			4.7	1	9.6	0.5	7.5	0.5	5.1	0.5	4.1	
$t_{PHZ}$	$\overline{OE}$	A	3.4	0.8	5	0.8	5	0.8	5	0.8	5	ns
$t_{PLZ}$			3.4	0.8	5	0.8	5	0.8	5	0.8	5	
$t_{PHZ}$	$\overline{OE}$	B	4.6	1.2	8.1	1.2	6.7	1	5.1	0.8	5	ns
$t_{PLZ}$			4.6	1.2	8.1	1.2	6.7	1	5.1	0.8	5	

operating characteristics,  $T_A = 25^\circ\text{C}$

PARAMETER			TEST CONDITIONS	$V_{CCA} = V_{CCB} = 1.2 \text{ V}$	$V_{CCA} = V_{CCB} = 1.5 \text{ V}$	$V_{CCA} = V_{CCB} = 1.8 \text{ V}$	$V_{CCA} = V_{CCB} = 2.5 \text{ V}$	$V_{CCA} = V_{CCB} = 3.3 \text{ V}$	UNIT
				TYP	TYP	TYP	TYP	TYP	
$C_{pdA}^\dagger$	A to B	Outputs Enabled	$C_L = 0,$ $f = 10 \text{ MHz},$ $t_r = t_f = 1 \text{ ns}$	1	1	1	1	2	pF
		Outputs Disabled		1	1	1	1		
	B to A	Outputs Enabled		12	13	14	15	16	
		Outputs Disabled		1	1	1	1	1	
$C_{pdB}^\dagger$	A to B	Outputs Enabled	$C_L = 0,$ $f = 10 \text{ MHz},$ $t_r = t_f = 1 \text{ ns}$	13	13	14	15	16	pF
		Outputs Disabled		1	1	1	1	1	
	B to A	Outputs Enabled		1	1	1	2	2	
		Outputs Disabled		1	1	1	1	1	

$^\dagger$  Power-dissipation capacitance per transceiver





**SN74AVC20T245**  
**20-BIT DUAL-SUPPLY BUS TRANSCEIVER**  
**WITH CONFIGURABLE VOLTAGE TRANSLATION AND 3-STATE OUTPUTS**  
SCE5566F – MAY 2004 – REVISED APRIL 2005

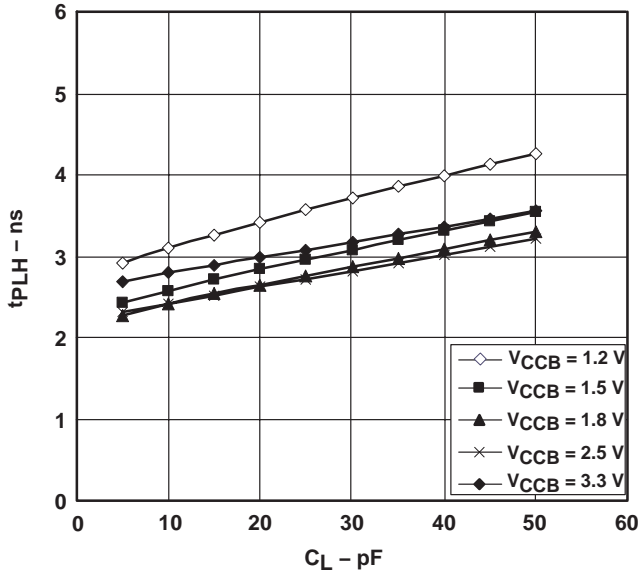
typical total static power consumption ( $I_{CCA} + I_{CCB}$ )

TABLE 1

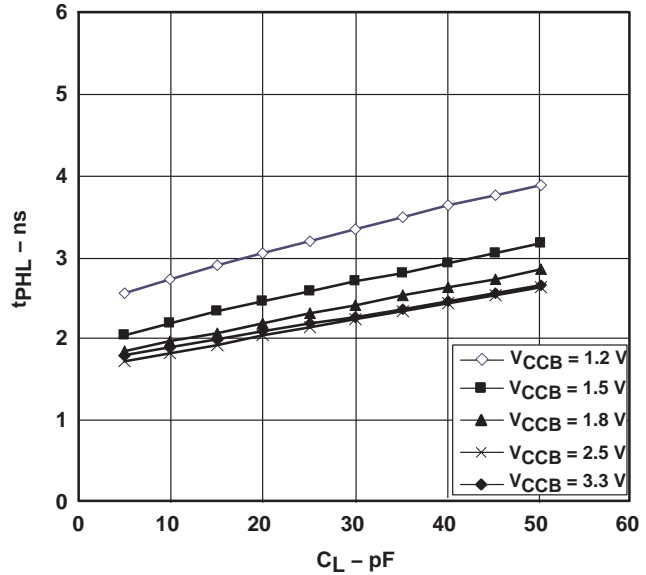
V <sub>CCB</sub>	V <sub>CCA</sub>						UNIT
	0 V	1.2 V	1.5 V	1.8 V	2.5 V	3.3 V	
0 V	0	< 0.5	< 0.5	< 0.5	< 0.5	< 0.5	μA
1.2 V	< 0.5	< 1	< 1	< 1	< 1	1	
1.5 V	< 0.5	< 1	< 1	< 1	< 1	1	
1.8 V	< 0.5	< 1	< 1	< 1	< 1	< 1	
2.5 V	< 0.5	1	< 1	< 1	< 1	< 1	
3.3 V	< 0.5	1	< 1	< 1	< 1	< 1	

**TYPICAL CHARACTERISTICS**

**TYPICAL PROPAGATION DELAY (A to B) vs LOAD CAPACITANCE**  
 $T_A = 25^\circ\text{C}, V_{CCA} = 1.2\text{ V}$

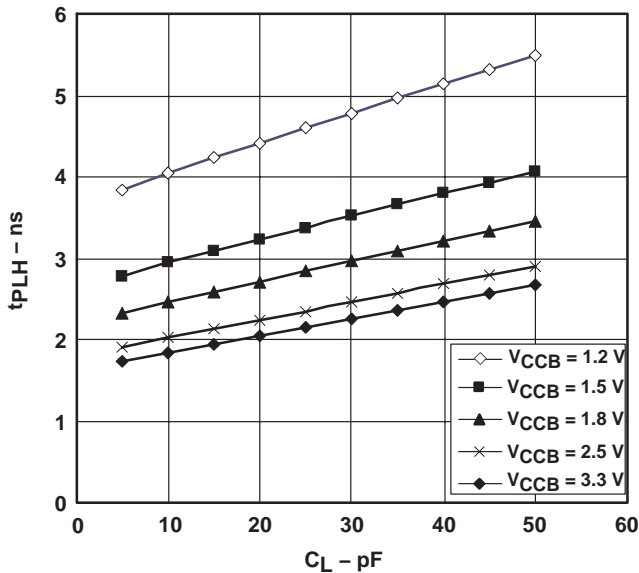


**Figure 1**

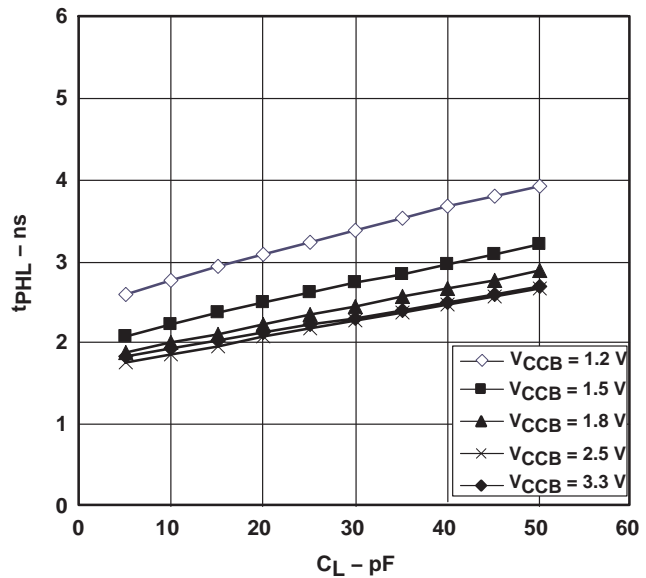


**Figure 2**

**TYPICAL PROPAGATION DELAY (A to B) vs LOAD CAPACITANCE**  
 $T_A = 25^\circ\text{C}, V_{CCA} = 1.5\text{ V}$



**Figure 3**



**Figure 4**

**SN74AVC20T245**  
**20-BIT DUAL-SUPPLY BUS TRANSCEIVER**  
**WITH CONFIGURABLE VOLTAGE TRANSLATION AND 3-STATE OUTPUTS**

SCE5566F – MAY 2004 – REVISED APRIL 2005

**TYPICAL PROPAGATION DELAY (A to B) vs LOAD CAPACITANCE**  
 $T_A = 25^\circ\text{C}$ ,  $V_{CCA} = 1.8\text{ V}$

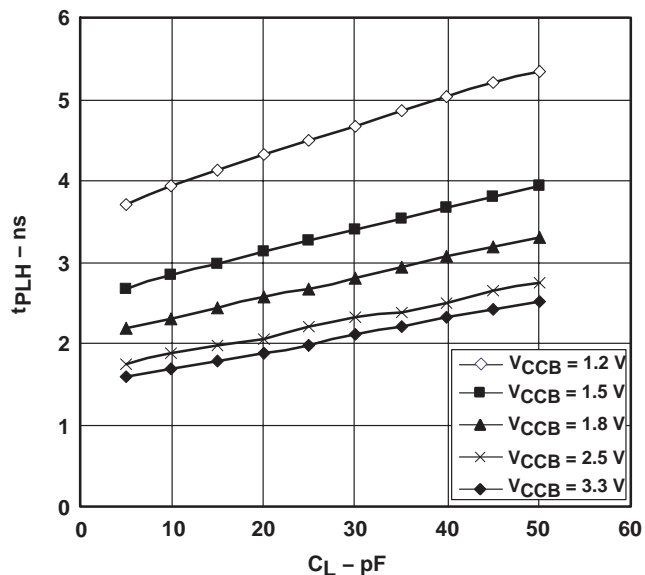


Figure 5

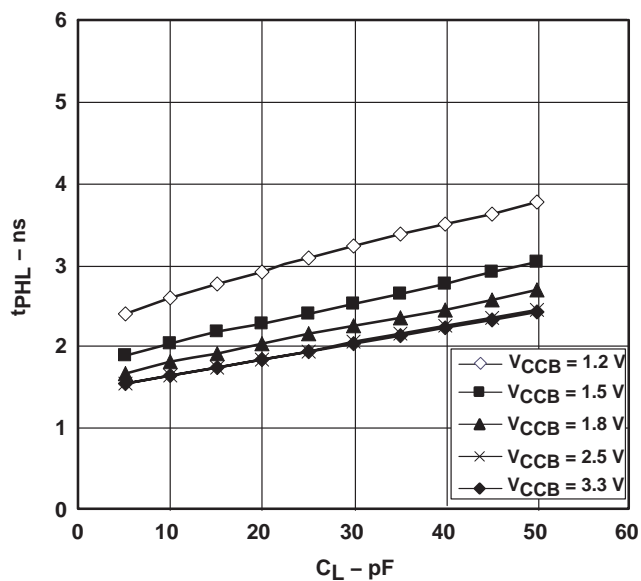


Figure 6

**TYPICAL PROPAGATION DELAY (A to B) vs LOAD CAPACITANCE**  
 $T_A = 25^\circ\text{C}$ ,  $V_{CCA} = 2.5\text{ V}$

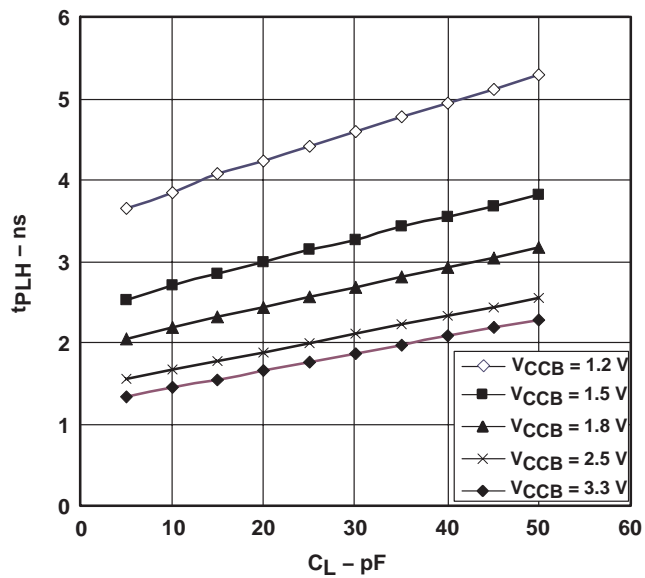


Figure 7

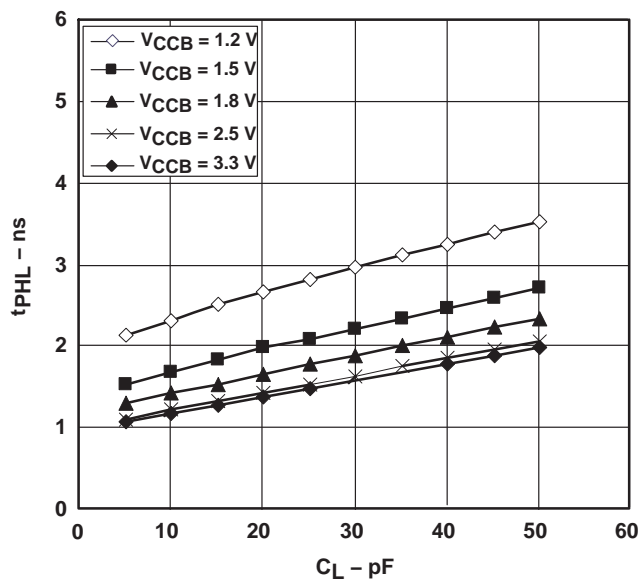


Figure 8

**SN74AVC20T245**  
**20-BIT DUAL-SUPPLY BUS TRANSCEIVER**  
**WITH CONFIGURABLE VOLTAGE TRANSLATION AND 3-STATE OUTPUTS**

SCES566F – MAY 2004 – REVISED APRIL 2005

**TYPICAL PROPAGATION DELAY (A to B) vs LOAD CAPACITANCE**  
 $T_A = 25^\circ\text{C}, V_{CCA} = 3.3\text{ V}$

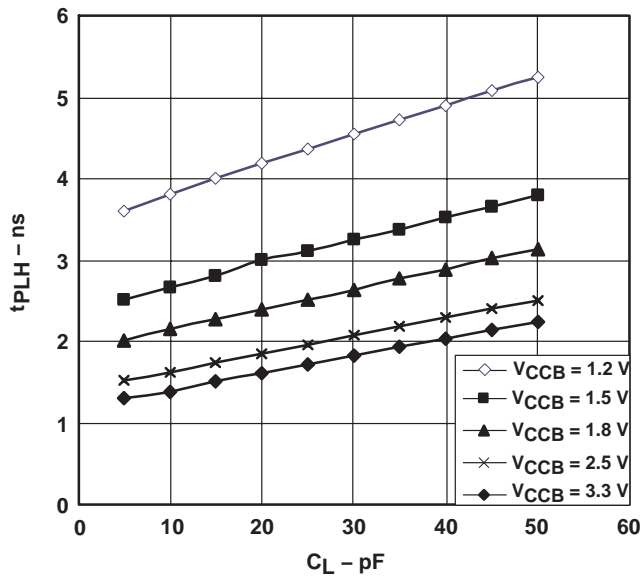


Figure 9

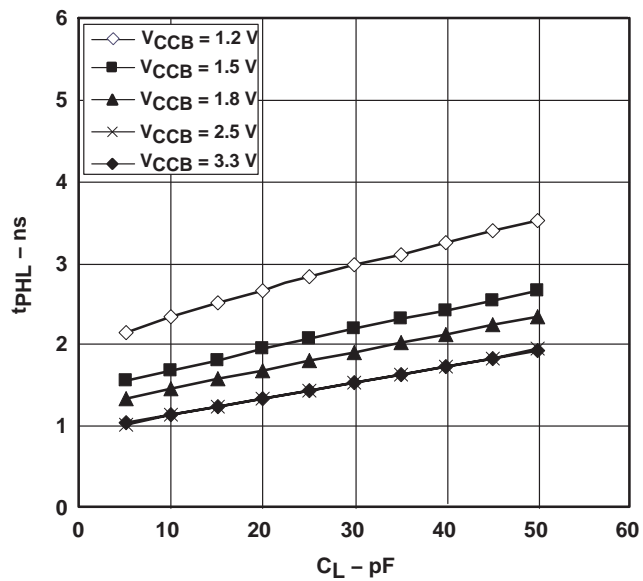
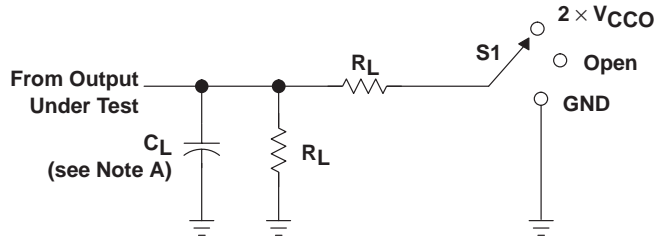


Figure 10

**SN74AVC20T245**  
**20-BIT DUAL-SUPPLY BUS TRANSCEIVER**  
**WITH CONFIGURABLE VOLTAGE TRANSLATION AND 3-STATE OUTPUTS**

SCES566F – MAY 2004 – REVISED APRIL 2005

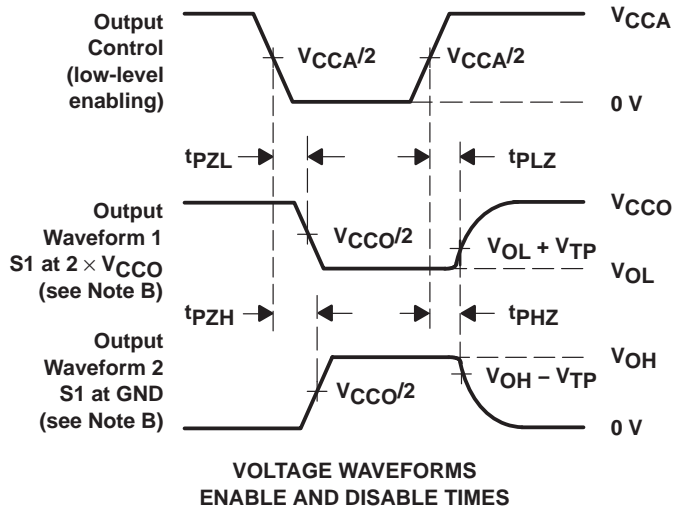
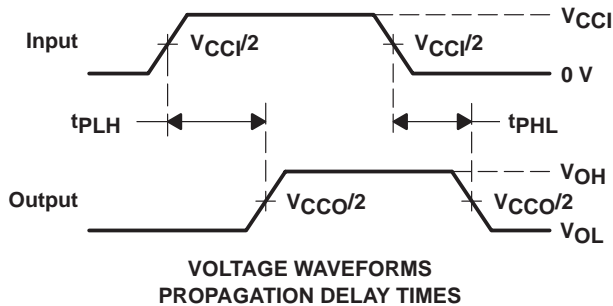
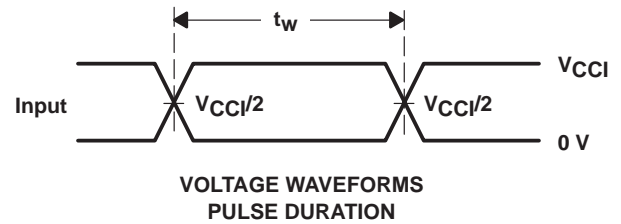
**PARAMETER MEASUREMENT INFORMATION**



**LOAD CIRCUIT**

TEST	S1
$t_{pd}$	Open
$t_{PLZ}/t_{PZL}$	$2 \times V_{CCO}$
$t_{PHZ}/t_{PZH}$	GND

$V_{CCO}$	$C_L$	$R_L$	$V_{TP}$
1.2 V	15 pF	2 k $\Omega$	0.1 V
1.5 V $\pm$ 0.1 V	15 pF	2 k $\Omega$	0.1 V
1.8 V $\pm$ 0.15 V	15 pF	2 k $\Omega$	0.15 V
2.5 V $\pm$ 0.2 V	15 pF	2 k $\Omega$	0.15 V
3.3 V $\pm$ 0.3 V	15 pF	2 k $\Omega$	0.3 V



- NOTES:
- $C_L$  includes probe and jig capacitance.
  - Waveform 1 is for an output with internal conditions such that the output is low, except when disabled by the output control. Waveform 2 is for an output with internal conditions such that the output is high, except when disabled by the output control.
  - All input pulses are supplied by generators having the following characteristics: PRR  $\leq$  10 MHz,  $Z_O = 50 \Omega$ ,  $dv/dt \geq 1$  V/ns.
  - The outputs are measured one at a time, with one transition per measurement.
  - $t_{PLZ}$  and  $t_{PHZ}$  are the same as  $t_{dis}$ .
  - $t_{PZL}$  and  $t_{PZH}$  are the same as  $t_{en}$ .
  - $t_{PLH}$  and  $t_{PHL}$  are the same as  $t_{pd}$ .
  - $V_{CCI}$  is the  $V_{CC}$  associated with the input port.
  - $V_{CCO}$  is the  $V_{CC}$  associated with the output port.

**Figure 11. Load Circuit and Voltage Waveforms**

**PACKAGING INFORMATION**

Orderable Device	Status (1)	Package Type	Package Drawing	Pins	Package Qty	Eco Plan (2)	Lead finish/ Ball material (6)	MSL Peak Temp (3)	Op Temp (°C)	Device Marking (4/5)	Samples
SN74AVC20T245DGG	ACTIVE	TSSOP	DGG	56	35	RoHS & Green	NIPDAU	Level-1-260C-UNLIM	-40 to 85	AVC20T245	<a href="#">Samples</a>
SN74AVC20T245DGGR	ACTIVE	TSSOP	DGG	56	2000	RoHS & Green	NIPDAU	Level-1-260C-UNLIM	-40 to 85	AVC20T245	<a href="#">Samples</a>
SN74AVC20T245DGVR	ACTIVE	TVSOP	DGV	56	2000	RoHS & Green	NIPDAU	Level-1-260C-UNLIM	-40 to 85	WG245	<a href="#">Samples</a>

(1) The marketing status values are defined as follows:

**ACTIVE:** Product device recommended for new designs.

**LIFEBUY:** TI has announced that the device will be discontinued, and a lifetime-buy period is in effect.

**NRND:** Not recommended for new designs. Device is in production to support existing customers, but TI does not recommend using this part in a new design.

**PREVIEW:** Device has been announced but is not in production. Samples may or may not be available.

**OBSOLETE:** TI has discontinued the production of the device.

(2) **RoHS:** TI defines "RoHS" to mean semiconductor products that are compliant with the current EU RoHS requirements for all 10 RoHS substances, including the requirement that RoHS substance do not exceed 0.1% by weight in homogeneous materials. Where designed to be soldered at high temperatures, "RoHS" products are suitable for use in specified lead-free processes. TI may reference these types of products as "Pb-Free".

**RoHS Exempt:** TI defines "RoHS Exempt" to mean products that contain lead but are compliant with EU RoHS pursuant to a specific EU RoHS exemption.

**Green:** TI defines "Green" to mean the content of Chlorine (Cl) and Bromine (Br) based flame retardants meet JS709B low halogen requirements of <=1000ppm threshold. Antimony trioxide based flame retardants must also meet the <=1000ppm threshold requirement.

(3) MSL, Peak Temp. - The Moisture Sensitivity Level rating according to the JEDEC industry standard classifications, and peak solder temperature.

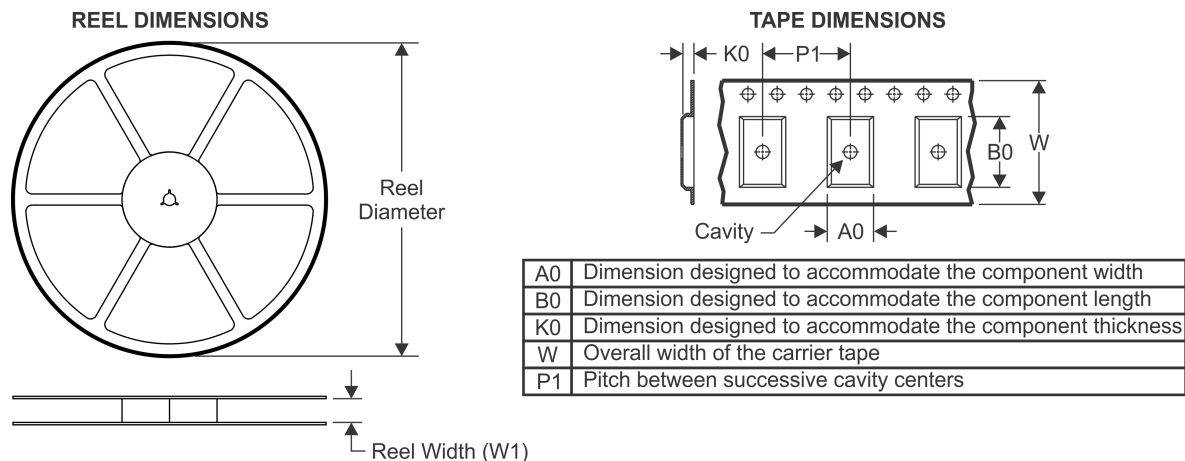
(4) There may be additional marking, which relates to the logo, the lot trace code information, or the environmental category on the device.

(5) Multiple Device Markings will be inside parentheses. Only one Device Marking contained in parentheses and separated by a "~" will appear on a device. If a line is indented then it is a continuation of the previous line and the two combined represent the entire Device Marking for that device.

(6) Lead finish/Ball material - Orderable Devices may have multiple material finish options. Finish options are separated by a vertical ruled line. Lead finish/Ball material values may wrap to two lines if the finish value exceeds the maximum column width.

**Important Information and Disclaimer:**The information provided on this page represents TI's knowledge and belief as of the date that it is provided. TI bases its knowledge and belief on information provided by third parties, and makes no representation or warranty as to the accuracy of such information. Efforts are underway to better integrate information from third parties. TI has taken and continues to take reasonable steps to provide representative and accurate information but may not have conducted destructive testing or chemical analysis on incoming materials and chemicals. TI and TI suppliers consider certain information to be proprietary, and thus CAS numbers and other limited information may not be available for release.

In no event shall TI's liability arising out of such information exceed the total purchase price of the TI part(s) at issue in this document sold by TI to Customer on an annual basis.

**TAPE AND REEL INFORMATION**

**QUADRANT ASSIGNMENTS FOR PIN 1 ORIENTATION IN TAPE**


\*All dimensions are nominal

Device	Package Type	Package Drawing	Pins	SPQ	Reel Diameter (mm)	Reel Width W1 (mm)	A0 (mm)	B0 (mm)	K0 (mm)	P1 (mm)	W (mm)	Pin1 Quadrant
SN74AVC20T245DGGR	TSSOP	DGG	56	2000	330.0	24.4	8.6	15.6	1.8	12.0	24.0	Q1
SN74AVC20T245DGVR	TVSOP	DGV	56	2000	330.0	24.4	6.8	11.7	1.6	12.0	24.0	Q1



**TAPE AND REEL BOX DIMENSIONS**


\*All dimensions are nominal

Device	Package Type	Package Drawing	Pins	SPQ	Length (mm)	Width (mm)	Height (mm)
SN74AVC20T245DGGR	TSSOP	DGG	56	2000	367.0	367.0	45.0
SN74AVC20T245DGVR	TVSOP	DGV	56	2000	367.0	367.0	45.0

**TUBE**


\*All dimensions are nominal

Device	Package Name	Package Type	Pins	SPQ	L (mm)	W (mm)	T (μm)	B (mm)
SN74AVC20T245DGG	DGG	TSSOP	56	35	530	11.89	3600	4.9

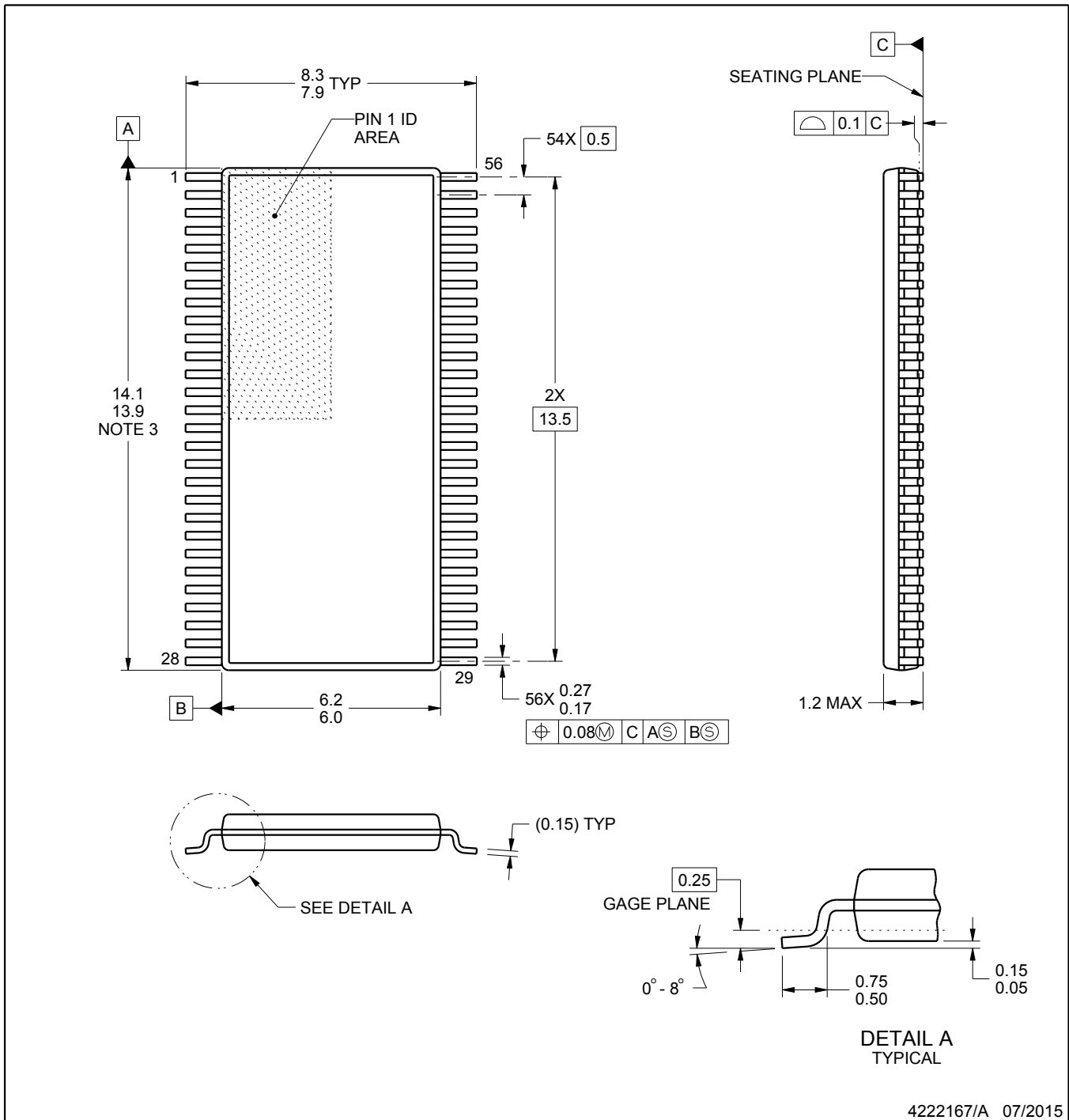
# DGG0056A



# PACKAGE OUTLINE

## TSSOP - 1.2 mm max height

SMALL OUTLINE PACKAGE



4222167/A 07/2015

### NOTES:

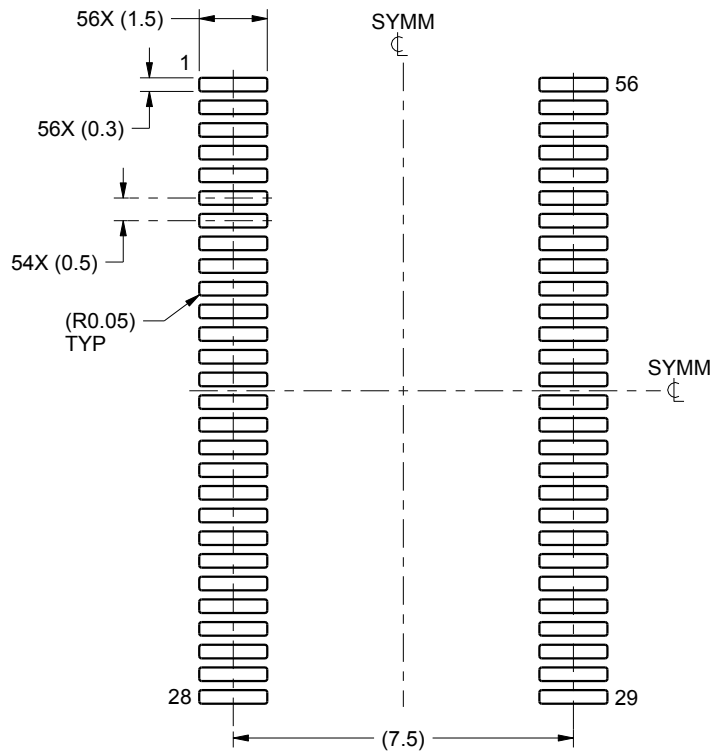
1. All linear dimensions are in millimeters. Any dimensions in parenthesis are for reference only. Dimensioning and tolerancing per ASME Y14.5M.
2. This drawing is subject to change without notice.
3. This dimension does not include mold flash, protrusions, or gate burrs. Mold flash, protrusions, or gate burrs shall not exceed 0.15 mm per side.
4. Reference JEDEC registration MO-153.

# EXAMPLE BOARD LAYOUT

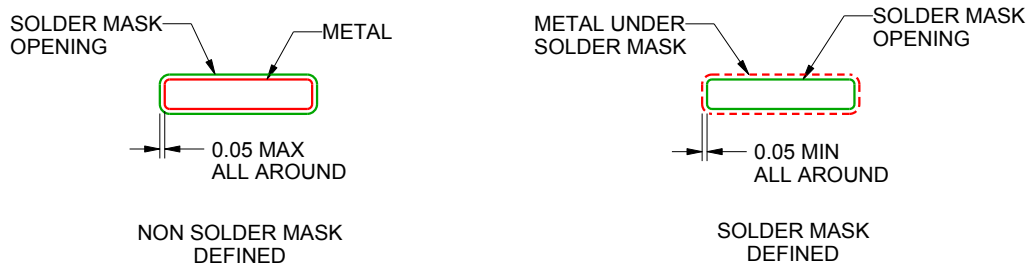
DGG0056A

TSSOP - 1.2 mm max height

SMALL OUTLINE PACKAGE



LAND PATTERN EXAMPLE  
SCALE:6X



SOLDER MASK DETAILS

4222167/A 07/2015

NOTES: (continued)

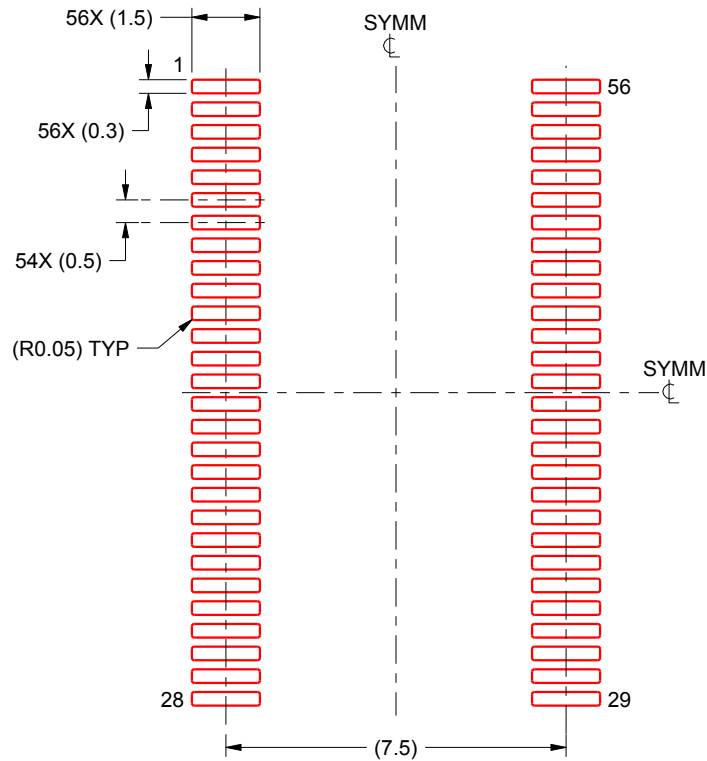
- 5. Publication IPC-7351 may have alternate designs.
- 6. Solder mask tolerances between and around signal pads can vary based on board fabrication site.

# EXAMPLE STENCIL DESIGN

DGG0056A

TSSOP - 1.2 mm max height

SMALL OUTLINE PACKAGE



SOLDER PASTE EXAMPLE  
BASED ON 0.125 mm THICK STENCIL  
SCALE:6X

4222167/A 07/2015

NOTES: (continued)

7. Laser cutting apertures with trapezoidal walls and rounded corners may offer better paste release. IPC-7525 may have alternate design recommendations.
8. Board assembly site may have different recommendations for stencil design.

DGV (R-PDSO-G\*\*)

PLASTIC SMALL-OUTLINE

24 PINS SHOWN



- NOTES: A. All linear dimensions are in millimeters.  
 B. This drawing is subject to change without notice.  
 C. Body dimensions do not include mold flash or protrusion, not to exceed 0,15 per side.  
 D. Falls within JEDEC: 24/48 Pins – MO-153  
 14/16/20/56 Pins – MO-194

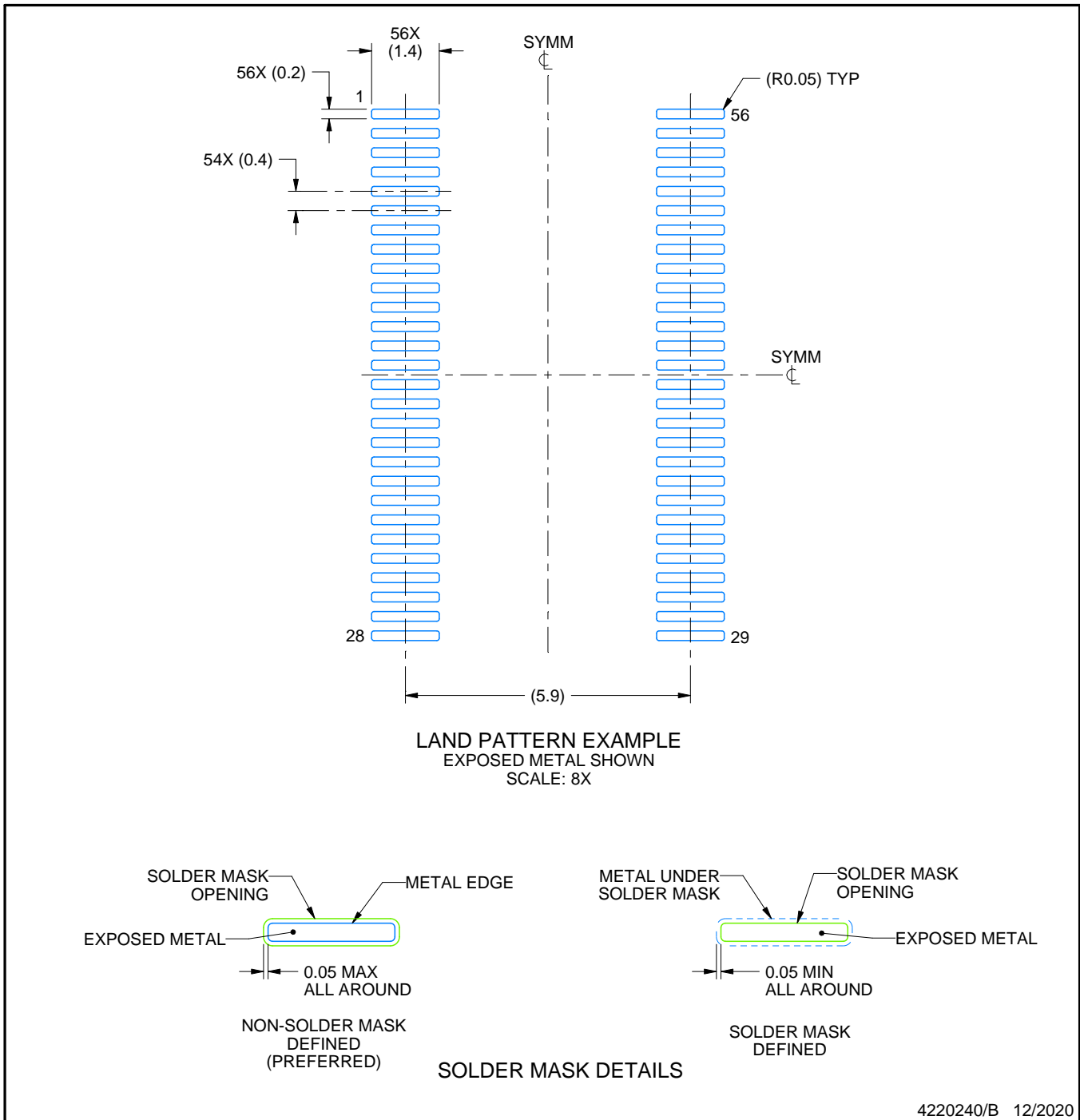


# EXAMPLE BOARD LAYOUT

DGV0056A

TVSOP - 1.2 mm max height

SMALL OUTLINE PACKAGE



NOTES: (continued)

6. Publication IPC-7351 may have alternate designs.

7. Solder mask tolerances between and around signal pads can vary based on board fabrication site.

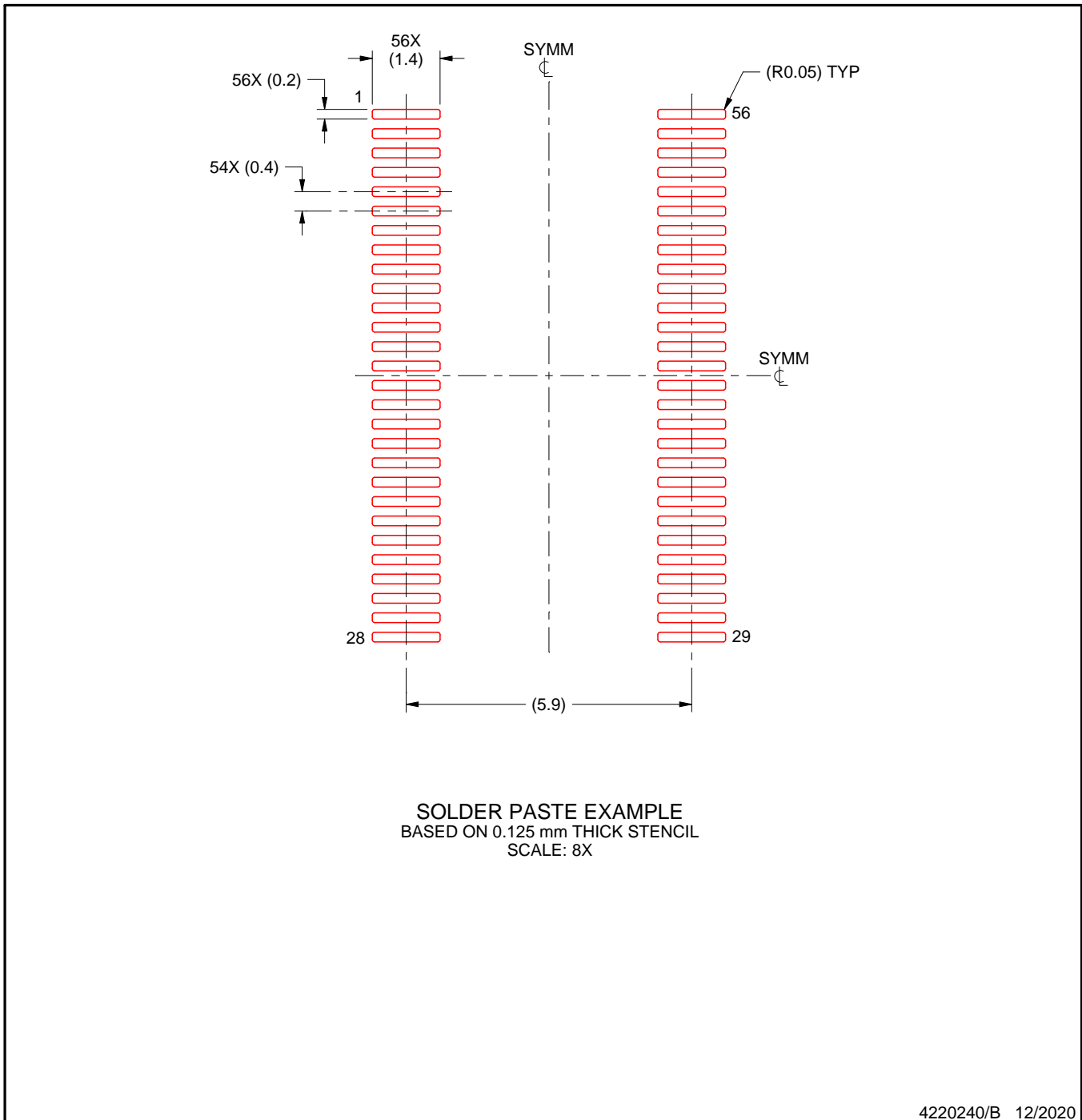


# EXAMPLE STENCIL DESIGN

DGV0056A

TVSOP - 1.2 mm max height

SMALL OUTLINE PACKAGE



NOTES: (continued)

8. Laser cutting apertures with trapezoidal walls and rounded corners may offer better paste release. IPC-7525 may have alternate design recommendations.
9. Board assembly site may have different recommendations for stencil design.

## IMPORTANT NOTICE AND DISCLAIMER

TI PROVIDES TECHNICAL AND RELIABILITY DATA (INCLUDING DATA SHEETS), DESIGN RESOURCES (INCLUDING REFERENCE DESIGNS), APPLICATION OR OTHER DESIGN ADVICE, WEB TOOLS, SAFETY INFORMATION, AND OTHER RESOURCES "AS IS" AND WITH ALL FAULTS, AND DISCLAIMS ALL WARRANTIES, EXPRESS AND IMPLIED, INCLUDING WITHOUT LIMITATION ANY IMPLIED WARRANTIES OF MERCHANTABILITY, FITNESS FOR A PARTICULAR PURPOSE OR NON-INFRINGEMENT OF THIRD PARTY INTELLECTUAL PROPERTY RIGHTS.

These resources are intended for skilled developers designing with TI products. You are solely responsible for (1) selecting the appropriate TI products for your application, (2) designing, validating and testing your application, and (3) ensuring your application meets applicable standards, and any other safety, security, regulatory or other requirements.

These resources are subject to change without notice. TI grants you permission to use these resources only for development of an application that uses the TI products described in the resource. Other reproduction and display of these resources is prohibited. No license is granted to any other TI intellectual property right or to any third party intellectual property right. TI disclaims responsibility for, and you will fully indemnify TI and its representatives against, any claims, damages, costs, losses, and liabilities arising out of your use of these resources.

TI's products are provided subject to [TI's Terms of Sale](#) or other applicable terms available either on [ti.com](http://ti.com) or provided in conjunction with such TI products. TI's provision of these resources does not expand or otherwise alter TI's applicable warranties or warranty disclaimers for TI products.

TI objects to and rejects any additional or different terms you may have proposed.

Mailing Address: Texas Instruments, Post Office Box 655303, Dallas, Texas 75265  
Copyright © 2022, Texas Instruments Incorporated