

DS125BR800 Low-Power 12.5-Gbps 8-Channel Repeater With Input Equalization and Output De-Emphasis

1 Features

- Comprehensive Family, Proven System Inter-Operability
 - DS125BR111: One-Lane Repeater
 - DS125BR401: Four-Lane Repeater
 - DS125BR800: Eight-Channel Repeater
 - DS125MB203: Two-Port 2:1/1:2 Mux/Switch
 - DS125DF410: Four-Channel Retimer With CDR
- Low 65-mW/Channel (Typical) Power Consumption, With Option to Power Down Unused Channels
- "Non-Limiting" Output for PCIe and 10G-KR Link Training Support
- Advanced Signal Conditioning Features
 - Receive Equalization up to 30 dB at 6.25 GHz
 - Transmit De-Emphasis up to –12 dB
 - Transmit Output Voltage Control: 700 mV to 1300 mV
- Programmable Through Pin Selection, EEPROM, or SMBus Interface
- Single Supply Voltage: 2.5 V or 3.3 V (Selectable)
- 40°C to 85°C Operating Temperature Range
- 3-kV HBM ESD Rating
- Flow-Thru Pinout: 54-Pin WQFN (10-mm × 5.5-mm, 0.5-mm Pitch)
- Supported Protocols
 - sRIO, Infiniband, Interlaken, CPRI, OBSAI
 - Other Proprietary Interface up to 12.5 Gbps

2 Applications

- SAS/SATA (up to 6 Gbps), Fibre Channel (up to 10GFC)
- PCIe Gen-3/2/1, 10G-KR, 10GbE, XAUI, RXAUI

3 Description

The DS125BR800 device is an extremely low-power high-performance multiprotocol repeater/redriver designed to support eight channels of PCIe Gen-3/2/1, 10G-KR, and other high-speed interface serial protocols up to 12.5 Gbps. The continuous time linear equalizer (CTLE) of the receiver provides a boost of up to +30 dB at 6.25 GHz (12.5 Gbps) in each of its eight channels and can open an input eye that is completely closed due to intersymbol interference (ISI) induced by interconnect medium such as 30in+ backplane traces or 8m+ copper cables, hence enabling host controllers to ensure an error-free end-to-end link. The transmitter provides a de-emphasis boost of up to –12 dB and output voltage amplitude control from 700 mV to 1300 mV to allow maximum flexibility in the physical placement within the interconnect channel.

Device Information⁽¹⁾

PART NUMBER	PACKAGE	BODY SIZE (NOM)
DS125BR800	WQFN (54)	10.00 mm × 5.50 mm

(1) For all available packages, see the orderable addendum at the end of the data sheet.

Typical Application

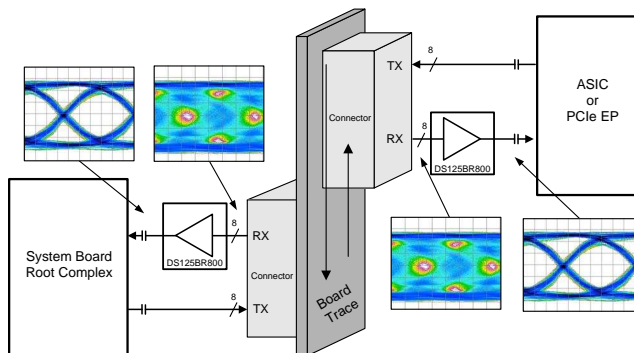

Table of Contents

1	Features	1	8.4	Device Functional Modes	15
2	Applications	1	8.5	Programming	15
3	Description	1	8.6	Register Maps	25
4	Revision History	2	9	Application and Implementation	44
5	Description (cont.)	3	9.1	Application Information	44
6	Pin Configuration and Functions	3	9.2	Typical Application	44
7	Specifications	6	10	Power Supply Recommendations	48
7.1	Absolute Maximum Ratings	6	10.1	3.3-V or 2.5-V Supply Mode Operation	48
7.2	ESD Ratings	6	10.2	Power Supply Bypassing	49
7.3	Recommended Operating Conditions	6	11	Layout	49
7.4	Thermal Information	6	11.1	Layout Guidelines	49
7.5	Electrical Characteristics	7	11.2	Layout Example	50
7.6	Electrical Characteristics: Serial Management Bus Interface	9	12	Device and Documentation Support	51
7.7	Timing Requirements	9	12.1	Documentation Support	51
7.8	Typical Characteristics	11	12.2	Receiving Notification of Documentation Updates	51
8	Detailed Description	12	12.3	Trademarks	51
8.1	Overview	12	12.4	Electrostatic Discharge Caution	51
8.2	Functional Block Diagram	12	12.5	Glossary	51
8.3	Feature Description	12	13	Mechanical, Packaging, and Orderable Information	51

4 Revision History

Changes from Revision E (January 2015) to Revision F

Page

- Changed $1/3 \times V_{DD}$ and $2/3 \times V_{DD}$ to $1/3 \times V_{IN}$ and $2/3 \times V_{IN}$ in the 3.3-V MODE column of the *4-Level Input Voltage* table **12**
- Changed $V_{IN} - 0.04 \text{ V}$ to $V_{DD} - 0.04 \text{ V}$ in the 2.5-V MODE column of the *4-Level Input Voltage* table **12**
- Added *Receiving Notification of Documentation Updates* section **51**

Changes from Revision D (March 2013) to Revision E

Page

- Added *Pin Configuration and Functions* section, *ESD Ratings* table, *Feature Description* section, *Device Functional Modes*, *Application and Implementation* section, *Power Supply Recommendations* section, *Layout* section, *Device and Documentation Support* section, and *Mechanical, Packaging, and Orderable Information* section **1**

5 Description (cont.)

When operating in 10G-KR and PCIe Gen-3 mode, the DS125BR800 transparently allows the host controller and the end point to optimize the full link and negotiate transmit equalizer coefficients. This seamless management of the link training protocol ensures system-level interoperability with minimum latency. With a low power consumption of 65 mW per channel (typical) and option to turn off unused channels, the DS125BR800 enables energy efficient system design. A single supply of 3.3 V or 2.5 V is required to power the device.

The programmable settings can be applied easily through pins, software (SMBus or I2C) or loaded through an external EEPROM. When operating in the EEPROM mode, the configuration information is automatically loaded on power up, which eliminates the need for an external microprocessor or software driver.

6 Pin Configuration and Functions

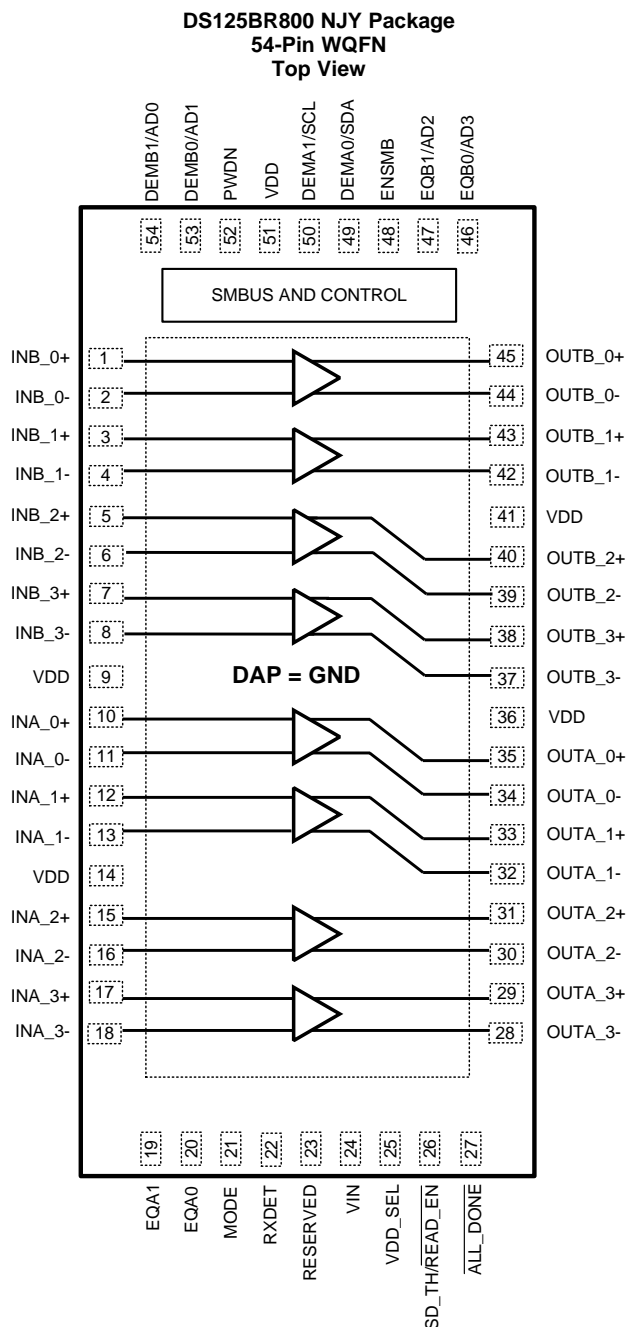

Pin Functions⁽¹⁾

PIN		TYPE	DESCRIPTION
NAME	NO.		
DIFFERENTIAL HIGH SPEED I/O'S			
INA_0+, INA_0-, INA_1+, INA_1-, INA_2+, INA_2- ,INA_3+, INA_3-	10, 11, 12, 13, 15, 16, 17, 18	I	Inverting and noninverting CML differential inputs to the equalizer. On-chip, 50-Ω termination resistor connects INA_n+ to VDD and INA_n- to VDD when enabled. AC coupling required on high-speed I/O
INB_0+, INB_0-, INB_1+, INB_1-, INB_2+, INB_2- ,INB_3+, INB_3-,	1, 2, 3, 4, 5, 6, 7, 8,	I	Inverting and noninverting CML differential inputs to the equalizer. On-chip, 50-Ω termination resistor connects INB_n+ to VDD and INB_n- to VDD when enabled. AC coupling required on high-speed I/O
OUTA_0+, OUTA_0-, OUTA_1+, OUTA_1-, OUTA_2+, OUTA_2-, OUTA_3+, OUTA_3-	35, 34, 33, 32, 31, 30, 29, 28	O	Inverting and noninverting 50-Ω driver outputs with de-emphasis. Compatible with AC-coupled CML inputs. AC coupling required on high-speed I/O
OUTB_0+, OUTB_0-, OUTB_1+, OUTB_1-, OUTB_2+, OUTB_2-, OUTB_3+, OUTB_3-,	45, 44, 43, 42, 40, 39, 38, 37	O	Inverting and noninverting 50-Ω driver outputs with de-emphasis. Compatible with AC-coupled CML inputs. AC coupling required on high-speed I/O
CONTROL PINS — SHARED (LVCMOS)			
ENSMB	48	I, 4-LEVEL, LVCMOS	System Management Bus (SMBus) Enable pin Tie 1 kΩ to VDD = Register Access SMBus Slave Mode FLOAT = Read External EEPROM (Master SMBUS Mode) Tie 1 kΩ to GND = Pin Mode
ENSMB = 1 (SMBUS MODE)			
AD0-AD3	54, 53, 47, 46	I, 4-LEVEL, LVCMOS	ENSMB Master or Slave mode SMBus Slave Address Inputs. In SMBus mode, these pins are the user set SMBus slave address inputs. There are 16 addresses supported by these pins. Pins must be tied LOW or HIGH when used to define the device SMBus address.
READ_EN	26	I, 2-LEVEL, LVCMOS	When using an External EEPROM, a transition from high to low starts the load from the external EEPROM
SCL	50	I, 2-LEVEL, LVCMOS, O, OPEN Drain	Clock output when loading EEPROM configuration, reverting to SMBus clock input when EEPROM load is complete (ALL_DONE = 0). External 2-kΩ to 5-kΩ pullup resistor to VDD (2.5-V Mode) or VIN (3.3-V Mode) recommended as per SMBus interface standards.
SDA	49	I, 2-LEVEL, LVCMOS, O, OPEN Drain	In both SMBus Modes, this pin is the SMBus data I/O. Data input or open-drain output. External 2-kΩ to 5-kΩ pullup resistor to VDD (2.5-V Mode) or VIN (3.3-V Mode) recommended as per SMBus interface standards.
ENSMB = 0 (PIN MODE)			
DEMA0, DEMA1, DEMB0, DEMB1	49, 50, 53, 54	I, 4-LEVEL, LVCMOS	DEMA[1:0] and DEMB[1:0] control the level of de-emphasis of the output driver. The pins are only active when ENSMB is de-asserted (low). The 8 channels are organized into two banks. Bank A is controlled with the DEMA[1:0] pins and bank B is controlled with the DEMB[1:0] pins. When ENSMB goes high the SMBus registers provide independent control of each channel. The DEMA[1:0] pins are converted to SMBUS SCL/SDA and DEMB[1:0] pins are converted to AD0, AD1 inputs. See Table 3 .
EQA0, EQA1, EQB0, EQB1	20, 19, 46, 47	I, 4-LEVEL, LVCMOS	EQA[1:0] and EQB[1:0] control the level of equalization on the input pins. The pins are active only when ENSMB is deasserted (low). The 8 channels are organized into two banks. Bank A is controlled with the EQA[1:0] pins and bank B is controlled with the EQB[1:0] pins. When ENSMB goes high the SMBus registers provide independent control of each channel. The EQB[1:0] pins are converted to SMBUS AD2/AD3 inputs. See Table 2 .

- (1) LVCMOS inputs without the FLOAT conditions must be driven to a logic low or high at all times or operation is not ensured.
Input edge rate for LVCMOS/FLOAT inputs must be faster than 50 ns from 10–90%.
For 3.3-V Mode operation, VIN pin = 3.3 V and the VDD for the 4-level input is 3.3 V.
For 2.5-V Mode operation, VDD pin = 2.5 V and the VDD for the 4-level input is 2.5 V.

Pin Functions⁽¹⁾ (continued)

PIN		TYPE	DESCRIPTION
NAME	NO.		
MODE	21	I, 4-LEVEL, LVCMOS	MODE control pin selects operating modes. Tie 1 k Ω to GND = PCIe Gen-1 or PCIe Gen-2 and SAS/SATA (up to 6 Gbps) FLOAT = AUTO Rate Select (for PCIe) Tie 20 k Ω to GND = PCIe Gen-3 without De-emphasis Tie 1 k Ω to VDD = PCIe Gen-3 with De-emphasis See Table 6
SD_TH	26	I, 4-LEVEL, LVCMOS	Controls the internal Signal Detect Threshold. For data rates above 8 Gbps the Signal Detect function should be disabled to avoid potential for intermittent data loss. See Table 5 for additional information.
CONTROL PINS — BOTH PIN AND SMBus MODES (LVCMOS)			
PWDN	52	I, LVCMOS	Tie High = Low power - power down Tie GND = Normal Operation See Table 4 .
RESERVED	23	I, FLOAT	Float (leave pin open) = Normal Operation
RXDET	22	I, 4-LEVEL, LVCMOS	The RXDET pin controls the receiver detect function. Depending on the input level, a 50 Ω or >50-k Ω termination to the power rail is enabled. See Table 4 .
VDD_SEL	25	I, LVCMOS	Controls the internal regulator FLOAT = 2.5-V mode Tie GND = 3.3-V mode
OUTPUTS			
ALL_DONE	27	O, LVCMOS	Valid Register Load Status Output HIGH = External EEPROM load failed LOW = External EEPROM load passed
POWER			
GND	DAP	Power	Ground pad (DAP - die attach pad)
VDD	9, 14, 36, 41, 51	Power	Power supply pins CML/analog 2.5-V Mode, connect to 2.5-V supply 3.3-V mode, connect 0.1- μ F cap to each VDD pin See Power Supply Recommendations for proper power supply decoupling.
VIN	24	Power	In 3.3-V mode, feed 3.3 V to VIN In 2.5-V mode, leave floating

7 Specifications

7.1 Absolute Maximum Ratings⁽¹⁾⁽²⁾⁽³⁾

	MIN	MAX	UNIT
Supply voltage (VDD - 2.5-V mode)	-0.5	2.75	V
Supply voltage (VIN - 3.3-V mode)	-0.5	4	V
LVC MOS Input/Output Voltage	-0.5	4	V
CML input voltage	-0.5	VDD + 0.5	V
CML input current	-30	30	mA
Junction temperature		125	°C
Lead temperature soldering (4 sec.)		260	°C
Storage temperature, T _{stg}	-40	125	°C

- (1) Absolute Maximum Ratings indicate limits beyond which damage to the device may occur, including inoperability and degradation of device reliability and/or performance. Functional operation of the device and/or non-degradation at the Absolute Maximum Ratings or other conditions beyond those indicated in the [Recommended Operating Conditions](#) is not implied. The Recommended Operating Conditions indicate conditions at which the device is functional and the device should not be operated beyond such conditions. Absolute Maximum Numbers are specified for a junction temperature range of -40°C to +125°C. Models are validated to Maximum Operating Voltages only.
- (2) For soldering specifications: see product folder at [Absolute Maximum Ratings for Soldering](#) (SNOA549).
- (3) If Military/Aerospace specified devices are required, contact the Texas Instruments Sales Office/Distributors for availability and specifications.

7.2 ESD Ratings

		VALUE	UNIT
V _(ESD)	Electrostatic discharge		
	Human body model (HBM), per ANSI/ESDA/JEDEC JS-001, all pins ⁽¹⁾	±3000	V
	Charged device model (CDM), per JEDEC specification JESD22-C101, all pins ⁽²⁾	±1000	
Machine model, STD - JESD22-A115-A	±200		

- (1) JEDEC document JEP155 states that 500-V HBM allows safe manufacturing with a standard ESD control process.
- (2) JEDEC document JEP157 states that 250-V CDM allows safe manufacturing with a standard ESD control process.

7.3 Recommended Operating Conditions

	MIN	TYP	MAX	UNIT
Supply voltage (2.5-V mode)	2.375	2.5	2.625	V
Supply voltage (3.3-V mode)	3	3.3	3.6	V
Ambient temperature	-40	25	85	°C
SMBus (SDA, SCL)			3.6	V
Supply noise up to 50 MHz ⁽¹⁾			100	mVp-p

- (1) Allowed supply noise (mVp-p sine wave) under typical conditions.

7.4 Thermal Information

THERMAL METRIC ⁽¹⁾		DS125BR800	UNIT
		NJY (WQFN)	
		54 PINS	
R _{θJA}	Junction-to-ambient thermal resistance	26.6	°C/W
R _{θJC(top)}	Junction-to-case (top) thermal resistance	10.8	°C/W
R _{θJB}	Junction-to-board thermal resistance	4.4	°C/W
ψ _{JT}	Junction-to-top characterization parameter	0.2	°C/W
ψ _{JB}	Junction-to-board characterization parameter	4.3	°C/W
R _{θJC(bot)}	Junction-to-case (bottom) thermal resistance	1.5	°C/W

- (1) For more information about traditional and new thermal metrics, see the [Semiconductor and IC Package Thermal Metrics](#) application report (SPRA953).

7.5 Electrical Characteristics⁽¹⁾⁽²⁾⁽³⁾

PARAMETER		TEST CONDITIONS	MIN	TYP	MAX	UNIT
POWER						
PD	Power Dissipation	VDD = 2.5-V supply, EQ Enabled, VOD = 1.0 Vp-p, RXDET = 1, PWDN = 0	500	700		mW
		VIN = 3.3-V supply, EQ Enabled, VOD = 1.0 Vp-p, RXDET = 1, PWDN = 0	660	900		mW
LVC MOS / LV TTL DC SPECIFICATIONS						
V _{IH25}	High Level Input Voltage	2.5 V-Mode	2	VDD		V
V _{IH33}	High Level Input Voltage	3.3 V-Mode	2	VIN		V
V _{IL}	Low Level Input Voltage		0	0.8		V
V _{OH}	High Level Output Voltage (ALL_DONE pin)	I _{oh} = -4 mA	2			V
V _{OL}	Low Level Output Voltage (ALL_DONE pin)	I _{ol} = 4 mA			0.4	V
I _{IH}	Input High Current (PWDN pin)	VIN = 3.6 V, LVCMOS = 3.6 V	-15		15	μA
	Input High Current with internal resistors (4-level input pin)		20		150	μA
I _{IL}	Input Low Current (PWDN pin)	VIN = 3.6 V, LVCMOS = 0 V	-15		15	μA
	Input Low Current with internal resistors (4-level input pin)		-160		-40	μA
CML RECEIVER INPUTS (IN_{n+}, IN_{n-})						
RL _{RX-DIFF}	RX Differential return loss	0.05 - 7.5 GHz	-15			dB
		7.5 - 15 GHz	-5			dB
RL _{RX-CM}	RX Common mode return loss	0.05 - 5 GHz	-10			dB
Z _{RX-DC}	RX DC common mode impedance	Tested at VDD = 2.5 V	40	50	60	Ω
Z _{RX-DIFF-DC}	RX DC differential mode impedance	Tested at VDD = 2.5 V	80	100	120	Ω
V _{RX-DIFF-DC}	Differential RX peak to peak voltage (VID)	Tested at pins			1.2	V
V _{RX-SIGNAL-DET-DIFF-PP}	Signal detect assert level for active data signal	SD_TH = float, 0101 pattern at 8 Gbps		180		mVp-p
V _{RX-IDLE-DET-DIFF-PP}	Signal detect de-assert level for electrical idle	SD_TH = float, 0101 pattern at 8 Gbps		110		mVp-p
HIGH SPEED OUTPUTS						
V _{TX-DIFF-PP}	Output Voltage Differential Swing	Differential measurement with OUT _{n+} and OUT _{n-} , terminated by 50 Ω to GND, AC-Coupled, VID = 1.0 Vp-p, DEM0 = 1, DEM1 = 0 ⁽⁴⁾	0.8	1	1.2	Vp-p
V _{TX-DE-RATIO_3.5}	TX de-emphasis ratio	VOD = 1.0 Vp-p, DEM0 = 0, DEM1 = R PCIe Gen-1 or PCIe Gen-2 and SAS/SATA (up to 6 Gbps)	-3.5			dB

- (1) Typical values represent most likely parametric norms at VDD = 2.5 V, TA = 25°C., and at the [Recommended Operating Conditions](#) at the time of product characterization and are not guaranteed.
- (2) The Electrical Characteristics tables list specified specifications under the listed [Recommended Operating Conditions](#) except as otherwise modified or specified by the Electrical Characteristics Conditions and/or Notes. Typical specifications are estimations only and are **not** guaranteed.
- (3) Specified by device characterization.
- (4) In PCIe Gen-3 mode, the output VOD level is not fixed. It will be adjusted automatically based on the VID input amplitude level. The output VOD level set by DEMA/B[1:0] in this MODE is dependent on the VID level and the frequency content. The DS125BR800 repeater is designed to be non-limiting in this MODE, so the TX-FIR (de-emphasis) is passed to the RX to support the handshake negotiation link training.

Electrical Characteristics⁽¹⁾⁽²⁾⁽³⁾ (continued)

PARAMETER		TEST CONDITIONS	MIN	TYP	MAX	UNIT
$V_{TX-DE-RATIO_6}$	TX de-emphasis ratio	VOD = 1.0 Vp-p, DEM0 = R, DEM1 = R PCIe Gen-1 or PCIe Gen-2 and SAS/SATA (up to 6 Gbps)		-6		dB
T_{TX-DJ}	Deterministic Jitter	VID = 800 mV, PRBS15 pattern, 8.0 Gbps, VOD = 1.0 V, EQ = 0x00, DE = 0 dB, (no input or output trace loss)		0.05		Upp
T_{TX-RJ}	Random Jitter	VID = 800 mV, 0101 pattern, 8.0 Gbps, VOD = 1.0 V, EQ = 0x00, DE = 0 dB, (no input or output trace loss)		0.3		ps RMS
$T_{TX-RISE-FALL}$	TX rise/fall time	20% to 80% of differential output voltage	35	45		ps
$T_{RF-MISMATCH}$	TX rise/fall mismatch	20% to 80% of differential output voltage		0.01	0.1	UI
$RL_{TX-DIFF}$	TX Differential return loss	0.05 - 7.5 GHz		-15		dB
		7.5 - 15 GHz		-5		dB
RL_{TX-CM}	TX Common mode return loss	0.05 - 5 GHz		-10		dB
$Z_{TX-DIFF-DC}$	DC differential TX impedance			100		Ω
$V_{TX-CM-AC-PP}$	TX AC common mode voltage	VOD = 1.0 Vp-p, DEM0 = 1, DEM1 = 0			100	mVp-p
$I_{TX-SHORT}$	TX short circuit current limit	Total current the transmitter can supply when shorted to VDD or GND		20		mA
$V_{TX-CM-DC-ACTIVE-IDLE-DELTA}$	Absolute delta of DC common mode voltage during L0 and electrical idle				100	mV
$V_{TX-CM-DC-LINE-DELTA}$	Absolute delta of DC common mode voltage between TX+ and TX-				25	mV
$T_{TX-IDLE-DATA}$	Max time to transition to differential DATA signal after IDLE	VID = 1.0 Vp-p, 8 Gbps		3.5		ns
$T_{TX-DATA-IDLE}$	Max time to transition to IDLE after differential DATA signal	VID = 1.0 Vp-p, 8 Gbps		6.2		ns
$T_{PLHD/PHLD}$	Differential Propagation Delay	EQ = 00 ⁽⁵⁾		200		ps
T_{LSK}	Lane to lane skew	T = 25°C, VDD = 2.5 V		25		ps
T_{PPSK}	Part to part propagation delay skew	T = 25°C, VDD = 2.5 V		40		ps
EQUALIZATION						
DJE1	Residual deterministic jitter at 12 Gbps	30in 5mils FR4, VID = 0.6 Vp-p, PRBS15, EQ = 0x07, DEM = 0 dB		0.18		Upp
DJE2	Residual deterministic jitter at 8 Gbps	30in 5mils FR4, VID = 0.6 Vp-p, PRBS15, EQ = 0x07, DEM = 0 dB		0.11		Upp
DJE3	Residual deterministic jitter at 5 Gbps	30in 5mils FR4, VID = 0.6 Vp-p, PRBS15, EQ = 0x07, DEM = 0 dB		0.07		Upp
DJE4	Residual deterministic jitter at 12 Gbps	5m 30 awg cable, VID = 0.6 Vp-p, PRBS15, EQ = 0x07, DEM = 0 dB		0.25		Upp
DJE5	Residual deterministic jitter at 5 Gbps	8m 30 awg cable, VID = 0.6 Vp-p, PRBS15, EQ = 0x0F, DEM = 0 dB		0.33		Upp
DE-EMPHASIS — PCIe Gen-1 or PCIe Gen-2 and SAS/SATA (up to 6 Gbps)						
DJD1	Residual deterministic jitter at 12 Gbps	Input Channel: 20in 5mils FR4, Output Channel: 10in 5mils FR4 VID = 0.6 Vp-p, PRBS15, EQ = 0x03, VOD = 1.0 Vp-p, DEM = -3.5 dB		0.1		Upp

(5) Propagation Delay measurements will change slightly based on the level of EQ selected. EQ = 00 will result in the longest propagation delays.

7.6 Electrical Characteristics: Serial Management Bus Interface

over recommended operating supply and temperature ranges unless other specified.

PARAMETER		TEST CONDITIONS	MIN	TYP	MAX	UNIT
SERIAL BUS INTERFACE DC SPECIFICATIONS						
V _{IL}	Data, Clock Input Low Voltage				0.8	V
V _{IH}	Data, Clock Input High Voltage		2.1		3.6	V
I _{PULLUP}	Current Through Pull-Up Resistor or Current Source	High Power Specification	4			mA
V _{DD}	Nominal Bus Voltage		2.375		3.6	V
I _{LEAK-Bus}	Input Leakage Per Bus Segment	(1)	-200		200	μA
I _{LEAK-Pin}	Input Leakage Per Device Pin			-15		μA
C _I	Capacitance for SDA and SCL	(1) (2)			10	pF
R _{TERM}	External Termination Resistance pull to V _{DD} = 2.5 V ± 5% or 3.3 V ± 10%	Pullup V _{DD} = 3.3 V ⁽¹⁾ (2) (3)		2000		Ω
		Pullup V _{DD} = 2.5 V ⁽¹⁾ (2) (3)		1000		Ω

- (1) Recommended value.
 (2) Recommended maximum capacitance load per bus segment is 400 pF.
 (3) Maximum termination voltage should be identical to the device supply voltage.

7.7 Timing Requirements

		MIN	TYP	MAX	UNIT
SERIAL BUS INTERFACE TIMING SPECIFICATIONS					
FSMB	Bus Operating Frequency ⁽¹⁾	ENSMB = VDD (Slave Mode)		400	kHz
		ENSMB = FLOAT (Master Mode)	280	400	520
TBUF	Bus Free Time Between Stop and Start Condition	1.3			μs
THD:STA	Hold time after (Repeated) Start Condition. After this period, the first clock is generated.	At I _{PULLUP} , Max		0.6	μs
TSU:STA	Repeated Start Condition Setup Time	0.6			μs
TSU:STO	Stop Condition Setup Time	0.6			μs
THD:DAT	Data Hold Time	0			ns
TSU:DAT	Data Setup Time	100			ns
T _{LOW}	Clock Low Period	1.3			μs
T _{HIGH}	Clock High Period	(2)0.6		50	μs
t _F	Clock/Data Fall Time	(2)		300	ns
t _R	Clock/Data Rise Time	(2)		300	ns
t _{POR}	Time in which a device must be operational after power-on reset	(2) (3)		500	ms

- (1) In Master Mode, a serial EEPROM with a minimum rating of 520 KHz is required.
 (2) Compliant to SMBus 2.0 physical layer specification. See System Management Bus (SMBus) Specification Version 2.0, section 3.1.1 SMBus common AC specifications for details.
 (3) Specified by Design. Parameter not tested in production.

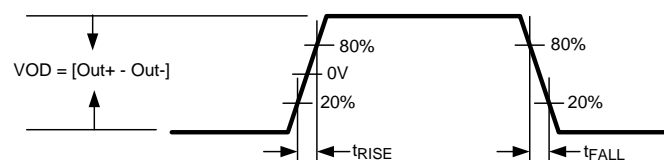

Figure 1. CML Output and Rise and FALL Transition Time

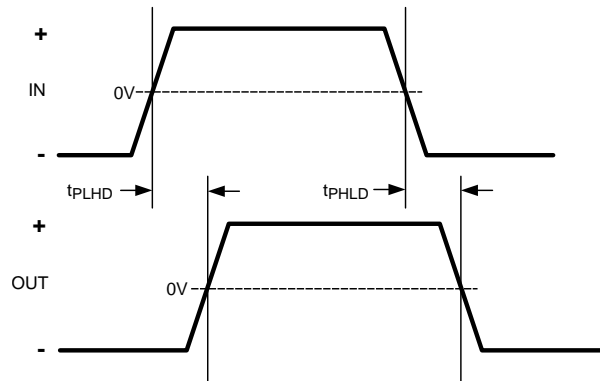

Figure 2. Propagation Delay Timing Diagram

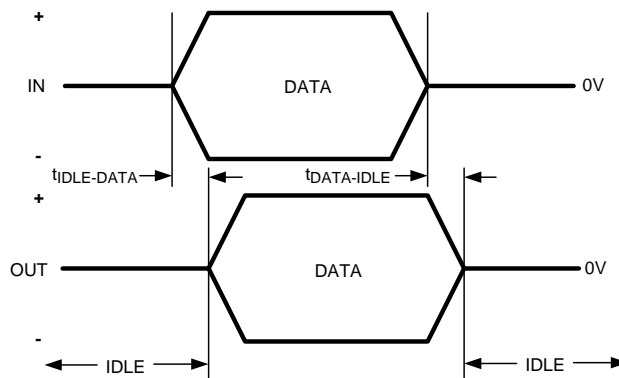

Figure 3. Transmit IDLE-DATA and DATA-IDLE Response Time

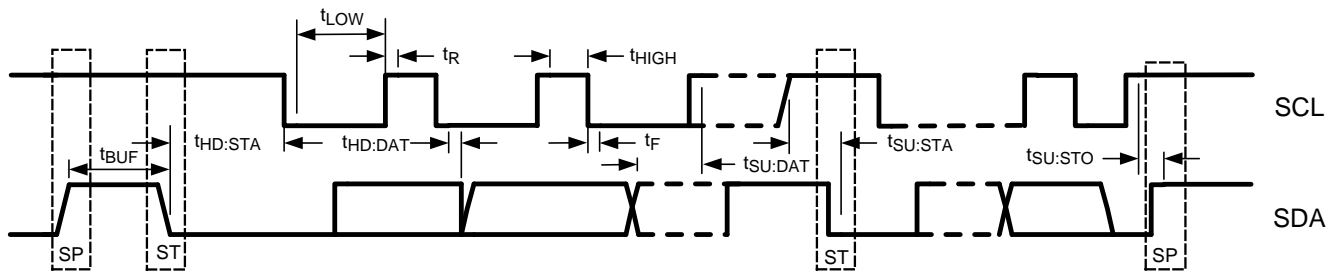

Figure 4. SMBus Timing Parameters

7.8 Typical Characteristics

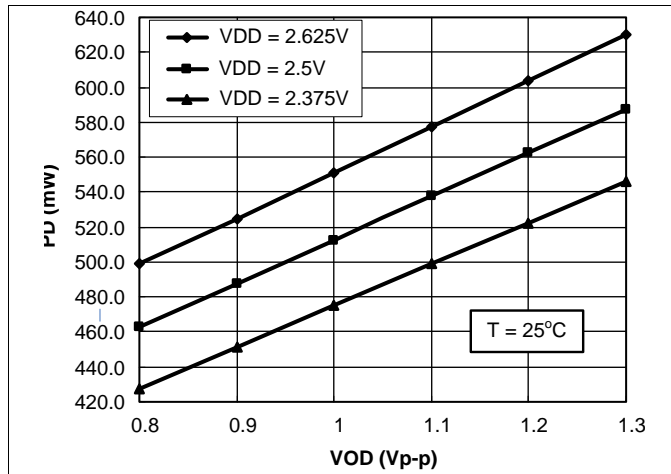

Figure 5. Power Dissipation (PD) vs Output Differential Voltage (VOD)

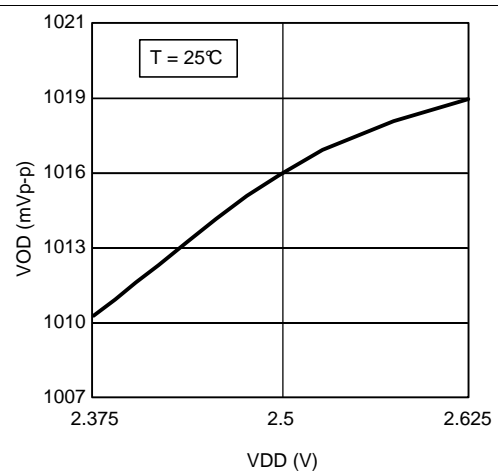

Figure 6. Output Differential Voltage (VOD = 1.0 Vp-p) vs Supply Voltage (VDD)

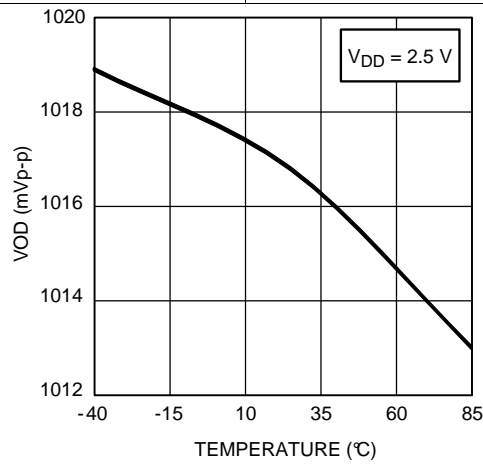

Figure 7. Output Differential Voltage (VOD = 1.0 Vp-p) vs. Temperature

8 Detailed Description

8.1 Overview

The DS125BR800 compensates for lossy printed-circuit board backplanes and balanced cables.

The DS125BR800 operates in 3 modes: Pin Control Mode (ENSMB = 0), SMBus Slave Mode (ENSMB = 1) and SMBus Master Mode (ENSMB = float) to load register information from external EEPROM. Refer to [SMBUS Master Mode](#) for more information.

8.2 Functional Block Diagram

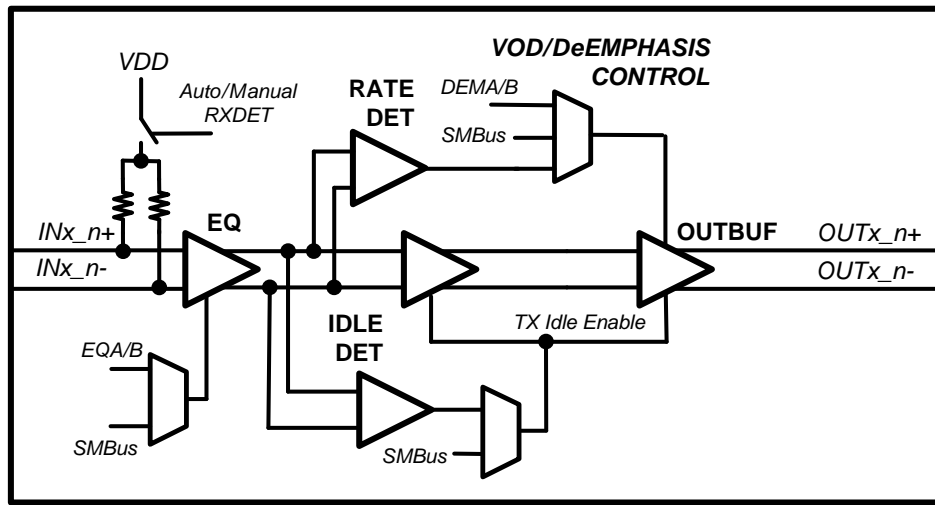

Figure 8. Block Diagram - Detail View of Channel (1 of 8)

8.3 Feature Description

8.3.1 4-Level Input Configuration Guidelines

The 4-level input pins use a resistor divider to help set the 4 valid levels and provide a wider range of control settings when ENSMB=0. There is an internal 30-kΩ pullup and a 60-kΩ pulldown connected to the package pin. These resistors, together with the external resistor connection combine to achieve the desired voltage level. Using the 1-kΩ pullup, 1-kΩ pulldown, no connect, and 20-kΩ pulldown provide the optimal voltage levels for each of the four input states.

Table 1. 4-Level Input Voltage

LEVEL	SETTING	3.3-V MODE	2.5-V MODE
0	Tie 1 kΩ to GND	0.10 V	0.08 V
R	Tie 20 kΩ to GND	$1/3 \times V_{IN}$	$1/3 \times V_{DD}$
Float	Float (leave pin open)	$2/3 \times V_{IN}$	$2/3 \times V_{DD}$
1	Tie 1 kΩ to V _{DD}	$V_{IN} - 0.05 \text{ V}$	$V_{DD} - 0.04 \text{ V}$

- Level 1 - 2 = $0.2 \times V_{IN}$ or V_{DD}
- Level 2 - 3 = $0.5 \times V_{IN}$ or V_{DD}
- Level 3 - 4 = $0.8 \times V_{IN}$ or V_{DD}

To minimize the startup current associated with the integrated 2.5-V regulator the 1-kΩ pullup and pulldown resistors are recommended. If several 4-level inputs require the same setting, it is possible to combine two or more 1-kΩ resistors into a single lower value resistor. For example, combining two inputs with a single 500-Ω resistor is a good way to save board space.

8.3.2 PCIe Signal Integrity

When using the DS125BR800 in PCIe Gen-3 systems, there are specific signal integrity settings to ensure signal integrity margin. The settings were achieved with completing extensive testing. Contact your field representative for more information regarding the testing completed to achieve these settings.

For tuning the in the downstream direction (from CPU to EP).

- EQ: use the guidelines outlined in [Table 2](#).
- De-Emphasis: use the guidelines outlined in [Table 3](#).
- VOD: use the guidelines outlined in [Table 3](#).

For tuning in the upstream direction (from EP to CPU).

- EQ: use the guidelines outlined in [Table 2](#).
- De-Emphasis:
 - For trace lengths < 15" set to -3.5 dB
 - For trace lengths > 15" set to -6 dB
- VOD: set to 900 mV

Table 2. Equalizer Settings

Level	EQA1 EQB1	EQA0 EQB	EQ – 8 bits [7:0]	dB at 1.5 GHz	dB at 2.5 GHz	dB at 4 GHz	dB at 6 GHz	Suggested Use ⁽¹⁾
1	0	0	0000 0000 = 0x00	2.5	3.5	3.8	3.1	FR4 < 5 inch trace
2	0	R	0000 0001 = 0x01	3.8	5.4	6.7	6.7	FR4 5-10 inch trace
3	0	Float	0000 0010 = 0x02	5.0	7.0	8.4	8.4	FR4 10 inch trace
4	0	1	0000 0011 = 0x03	5.9	8.0	9.3	9.1	FR4 15-20 inch trace
5	R	0	0000 0111 = 0x07	7.4	10.3	12.8	13.7	FR4 20-30 inch trace
6	R	R	0001 0101 = 0x15	6.9	10.2	13.9	16.2	FR4 25-30 inch trace
7	R	Float	0000 1011 = 0x0B	9.0	12.4	15.3	15.9	FR4 25-30 inch trace
8	R	1	0000 1111 = 0x0F	10.2	13.8	16.7	17.0	8m, 30awg cable
9	Float	0	0101 0101 = 0x55	8.5	12.6	17.5	20.7	> 8m cable
10	Float	R	0001 1111 = 0x1F	11.7	16.2	20.3	21.8	
11	Float	Float	0010 1111 = 0x2F	13.2	18.3	22.8	23.6	
12	Float	1	0011 1111 = 0x3F	14.4	19.8	24.2	24.7	
13	1	0	1010 1010 = 0xAA	14.4	20.5	26.4	28.0	
14	1	R	0111 1111 = 0x7F	16.0	22.2	27.8	29.2	
15	1	Float	1011 1111 = 0xBF	17.6	24.4	30.2	30.9	
16	1	1	1111 1111 = 0xFF	18.7	25.8	31.6	31.9	

(1) Cable and FR4 lengths are for reference only. FR4 lengths based on a 100 Ω differential stripline with 5-mil traces and 8-mil trace separation. Optimal EQ setting should be determined via simulation and prototype verification.

Table 3. Output Voltage and De-Emphasis Settings

Level	DEMA1 DEMB1	DEMA0 DEMB0	VOD Vp-p	DEM dB ⁽¹⁾	Inner Amplitude Vp-p	Suggested Use ⁽²⁾
1	0	0	0.8	0	0.8	FR4 < 5 inch 4-mil trace
2	0	R	0.9	0	0.9	FR4 < 5 inch 4-mil trace
3	0	Float	0.9	- 3.5	0.6	FR4 10 inch 4-mil trace
4	0	1	1.0	0	1.0	FR4 < 5 inch 4-mil trace
5	R	0	1.0	- 3.5	0.7	FR4 10 inch 4-mil trace
6	R	R	1.0	- 6	0.5	FR4 15 inch 4-mil trace
7	R	Float	1.1	0	1.1	FR4 < 5 inch 4-mil trace

(1) The VOD output amplitude and DEM de-emphasis levels are set with the DEMA/B[1:0] pins.

The de-emphasis levels are available in PCIe Gen-3 modes when MODE = 1 (tied to VIN)

(2) FR4 lengths are for reference only. FR4 lengths based on a 100 Ω differential stripline with 5-mil traces and 8-mil trace separation. Optimal DEM settings should be determined via simulation and prototype verification.

Table 3. Output Voltage and De-Emphasis Settings (continued)

Level	DEMA1 DEMB1	DEMA0 DEMB0	VOD Vp-p	DEM dB ⁽¹⁾	Inner Amplitude Vp-p	Suggested Use ⁽²⁾
8	R	1	1.1	- 3.5	0.7	FR4 10 inch 4–mil trace
9	Float	0	1.1	- 6	0.6	FR4 15 inch 4–mil trace
10	Float	R	1.2	0	1.2	FR4 < 5 inch 4–mil trace
11	Float	Float	1.2	- 3.5	0.8	FR4 10 inch 4–mil trace
12	Float	1	1.2	- 6	0.6	FR4 15 inch 4–mil trace
13	1	0	1.3	0	1.3	FR4 < 5 inch 4–mil trace
14	1	R	1.3	- 3.5	0.9	FR4 10 inch 4–mil trace
15	1	Float	1.3	- 6	0.7	FR4 15 inch 4–mil trace
16	1	1	1.3	- 9	0.5	FR4 20 inch 4–mil trace

Table 4. RX-Detect Settings

PWDN (PIN 52)	RXDET (PIN 22)	SMBus REG bit [3:2]	Input Termination	Recommended Use	Comments
0	0	00	Hi-Z	X	Manual RX-Detect, input is high impedance mode
0	Tie 20 kΩ to GND	01	Pre Detect: Hi-Z Post Detect: 50 Ω	PCIe Only	Auto RX-Detect, outputs test every 12 msec for 600 msec then stops; termination is Hi-Z until detection; once detected input termination is 50 Ω. Reset function by pulsing PWDN high for 5 μsec then low again
0	Float (Default)	10	Pre Detect: Hi-Z Post Detect: 50 Ω	PCIe Only	Auto RX-Detect, outputs test every 12 msec until detection occurs; termination is Hi-Z until RX detection; once detected input termination is 50 Ω.
0	1	11	50 Ω	All Others	Manual RX-Detect, input is 50 Ω.
1	X		High Impedance	X	Power down mode, input is Hi-Z, output drivers are disabled. Used to reset RX-Detect State Machine when held high for 5 μsec.

8.3.2.1 RX-Detect in SAS/SATA (up to 6 Gbps) Applications

Unlike PCIe systems, SAS/SATA (up to 6 Gbps) systems use a low speed Out-Of-Band or OOB communications sequence to detect and communicate between Controllers/Expanders and target drives. This communication eliminates the need to detect for endpoints like PCIe. For SAS/SATA systems, it is recommended to tie the RXDET pin high. This will ensure any OOB sequences sent from the Controller/Expander will reach the target drive without any additional latency due to the termination detection sequence defined by PCIe.

Table 5. Signal Detect Threshold Level⁽¹⁾

SD_TH (PIN 26)	SMBus REG Bit [3:2] and [1:0]	Assert Level (typ)	De-assert Level (typ)
0	10	210 mVp-p	150 mVp-p
R	01	160 mVp-p	100 mVp-p
F (default)	00	180 mVp-p	110 mVp-p
1	11	190 mVp-p	130 mVp-p

(1) VDD = 2.5 V, 25°C and 0101 pattern at 8 Gbps

8.3.2.1.1 Signal Detect Control for Datarates above 8 Gbps

Signal detect bandwidth limitations combined with high levels of signal attenuation can result in intermittent data loss above 8 Gbps. This data loss can be eliminated by disabling automatic detection and forcing the Signal Detect function to be always "on". This programming requires SMBus control over the DS125BR800 to be present. The Signal Detect function is controlled for each channel independently. The register programming sequence is shown below:

1. Write register 0x06 = 0x18 // * Enable SMBus register programming

2. Write registers 0x0D[1]= 1'b, 0x14[1] = 1'b, 0x1B[1] = 1'b, 0x22[1] = 1'b /* CH0 - CH3
3. Write registers 0x2A[1]= 1'b, 0x31[1] = 1'b, 0x38[1] = 1'b, 0x3F[1] = 1'b /* CH4 - CH7

Table 6. MODE Operation With Pin Control

MODE (PIN 21)	Driver Characteristics	PCIe	SAS SATA	10G-KR	10GbE	CPRI OBSAI	SRIO (R)XAUI	Interlaken Infiniband
0	Limiting		X		X	X	X	X
R	Transparent without DE							
F (default)	Automatic	X						
1	Transparent with DE			X				

NOTE: Automatic operation allows input to "sense" the incoming data-rate and utilize a "Transparent" output driver for operation at or above 8 Gbps.

NOTE: SAS/SATA up to 6 Gbps.

8.3.2.2 MODE Operation with SMBus Registers

When in SMBus mode (Slave or Master), the MODE pin retains control of the output driver characteristics. In order to override this control function, Register 0x08[2] must be written with a "1". Writing this bit enables MODE control of each channel individually using the channel registers defined in [Table 10](#).

8.4 Device Functional Modes

8.4.1 Pin Control Mode

When in pin mode (ENSMB = 0), equalization and de-emphasis can be selected via pin for each side independently. When de-emphasis is asserted VOD is automatically adjusted per [Table 3](#). For PCIe applications, the RXDET pins provides automatic and manual control for input termination (50 Ω or >50 kΩ). MODE setting is also pin controllable with pin selections (PCIe Gen-1, PCIe Gen-2, auto detect, and PCIe Gen-3). The receiver electrical idle detect threshold is also adjustable via the SD_TH pin.

8.4.2 SMBus Mode

When in SMBus mode (ENSMB = 1), the VOD (output amplitude), equalization, de-emphasis, and termination disable features are all programmable on a individual lane basis, instead of grouped by A or B as in the pin mode case. Upon assertion of ENSMB, the EQx and DEMx functions revert to register control immediately. The EQx and DEMx pins are converted to AD0-AD3 SMBus address inputs. The other external control pins (MODE, RXDET and SD_TH) remain active unless their respective registers are written to and the appropriate override bit is set, in which case they are ignored until ENSMB is driven low (pin mode). On power-up and when ENSMB is driven low all registers are reset to their default state. If PWDN is asserted while ENSMB is high, the registers retain their current state.

Equalization settings accessible via the pin controls were chosen to meet the needs of most high speed applications. If additional fine tuning or adjustment is needed, additional equalization settings can be accessed via the SMBus registers. Each input has a total of 256 possible equalization settings. [4-Level Input Configuration Guidelines](#) shows the 16 setting when the device is in pin mode. When using SMBus mode, the equalization, VOD and de-Emphasis levels are set by registers.

8.5 Programming

8.5.1 SMBus Master Mode

The DS125BR800 devices support reading directly from an external EEPROM device by implementing SMBus Master mode. When using the SMBus master mode, the DS125BR800 will read directly from specific location in the external EEPROM. When designing a system for using the external EEPROM, the user needs to follow these specific guidelines. For additional information, refer to [SNLA228](#).

- Set ENSMB = Float — enable the SMBUS master mode.
- The external EEPROM device address byte must be 0xA0 and capable of 520 kHz operation at 2.5 V and 3.3 V supply.

Table 7. EEPROM Register Map - Single Device with Default Value

EEPROM Address Byte		Bit 7	Bit 6	Bit 5	Bit 4	Bit 3	Bit 2	Bit 1	Bit 0
Description	0x00	CRC EN	Address Map Present	EEPROM > 256 Bytes	Reserved	DEVICE COUNT[3]	DEVICE COUNT[2]	DEVICE COUNT[1]	DEVICE COUNT[0]
Default Value		0	0	0	0	0	0	0	0
Description	0x01	Reserved	Reserved	Reserved	Reserved	Reserved	Reserved	Reserved	Reserved
Default Value		0	0	0	0	0	0	0	0
Description	0x02	Max EEPROM Burst size[7]	Max EEPROM Burst size[6]	Max EEPROM Burst size[5]	Max EEPROM Burst size[4]	Max EEPROM Burst size[3]	Max EEPROM Burst size[2]	Max EEPROM Burst size[1]	Max EEPROM Burst size[0]
Default Value		0	0	0	0	0	0	0	0
Description	0x03	PWDN_ch7	PWDN_ch6	PWDN_ch5	PWDN_ch4	PWDN_ch3	PWDN_ch2	PWDN_ch1	PWDN_ch0
SMBus Register		0x01 [7]	0x01 [6]	0x01 [5]	0x01 [4]	0x01 [3]	0x01 [2]	0x01 [1]	0x01 [0]
Default Value		0	0	0	0	0	0	0	0
Description	0x04	lpbk_1	lpbk_0	PWDN_INPUTS	PWDN_OSC	Ovrd_PWDN	Reserved	Reserved	Reserved
SMBus Register		0x02 [5]	0x02 [4]	0x02 [3]	0x02 [2]	0x02 [0]	0x04 [7]	0x04 [6]	0x04 [5]
Default Value		00	0	0	0	0	0	0	0
Description	0x05	Reserved	Reserved	Reserved	Reserved	Reserved	rxdet_bt看_en	Ovrd_idle_th	Ovrd_RES
SMBus Register		0x04 [4]	0x04 [3]	0x04 [2]	0x04 [1]	0x04 [0]	0x06 [4]	0x08 [6]	0x08 [5]
Default Value		04	0	0	0	0	1	0	0
Description	0x06	Ovrd_IDLE	Ovrd_RX_DET	Ovrd_MODE	Ovrd_RES	Ovrd_RES	rx_delay_sel_2	rx_delay_sel_1	rx_delay_sel_0
SMBus Register		0x08 [4]	0x08 [3]	0x08 [2]	0x08 [1]	0x08 [0]	0x0B [6]	0x0B [5]	0x0B [4]
Default Value		07	0	0	0	0	1	1	1
Description	0x07	RD_delay_sel_3	RD_delay_sel_2	RD_delay_sel_1	RD_delay_sel_0	ch0_idle_auto	ch0_idle_sel	ch0_RXDET_1	ch0_RXDET_0
SMBus Register		0x0B [3]	0x0B [2]	0x0B [1]	0x0B [0]	0x0E [5]	0x0E [4]	0x0E [3]	0x0E [2]
Default Value		00	0	0	0	0	0	0	0
Description	0x08	ch0_BST_7	ch0_BST_6	ch0_BST_5	ch0_BST_4	ch0_BST_3	ch0_BST_2	ch0_BST_1	ch0_BST_0
SMBus Register		0x0F [7]	0x0F [6]	0x0F [5]	0x0F [4]	0x0F [3]	0x0F [2]	0x0F [1]	0x0F [0]
Default Value		2F	0	1	0	1	1	1	1
Description	0x09	ch0_Sel_scp	ch0_Sel_mode	ch0_RES_2	ch0_RES_1	ch0_RES_0	ch0_VOD_2	ch0_VOD_1	ch0_VOD_0
SMBus Register		0x10 [7]	0x10 [6]	0x10 [5]	0x10 [4]	0x10 [3]	0x10 [2]	0x10 [1]	0x10 [0]
Default Value		AD	1	0	1	0	1	0	1
Description	0x0A	ch0_DEM_2	ch0_DEM_1	ch0_DEM_0	ch0_Slow	ch0_idle_tha_1	ch0_idle_tha_0	ch0_idle_thd_1	ch0_idle_thd_0
SMBus Register		0x11 [2]	0x11 [1]	0x11 [0]	0x12 [7]	0x12 [3]	0x12 [2]	0x12 [1]	0x12 [0]
Default Value		40	0	1	0	0	0	0	0

Table 7. EEPROM Register Map - Single Device with Default Value (continued)

EEPROM Address Byte		Bit 7	Bit 6	Bit 5	Bit 4	Bit 3	Bit 2	Bit 1	Bit 0
Description	0x0B	ch1_idle_auto	ch1_idle_sel	ch1_RXDET_1	ch1_RXDET_0	ch1_BST_7	ch1_BST_6	ch1_BST_5	ch1_BST_4
SMBus Register		0x15 [5]	0x15 [4]	0x15 [3]	0x15 [2]	0x16 [7]	0x16 [6]	0x16 [5]	0x16 [4]
Default Value		02	0	0	0	0	0	0	1
Description	0x0C	ch1_BST_3	ch1_BST_2	ch1_BST_1	ch1_BST_0	ch1_Sel_scp	ch1_Sel_mode	ch1_RES_2	ch1_RES_1
SMBus Register		0x16 [3]	0x16 [2]	0x16 [1]	0x16 [0]	0x17 [7]	0x17 [6]	0x17 [5]	0x17 [4]
Default Value		FA	1	1	1	1	1	0	1
Description	0x0D	ch1_RES_0	ch1_VOD_2	ch1_VOD_1	ch1_VOD_0	ch1_DEM_2	ch1_DEM_1	ch1_DEM_0	ch1_Slow
SMBus Register		0x17 [3]	0x17 [2]	0x17 [1]	0x17 [0]	0x18 [2]	0x18 [1]	0x18 [0]	0x19 [7]
Default Value		2F	1	1	0	1	0	1	0
Description	0x0E	ch1_idle_tha_1	ch1_idle_tha_0	ch1_idle_thd_1	ch1_idle_thd_0	ch2_Idle_auto	ch2_Idle_sel	ch2_RXDET_1	ch2_RXDET_0
SMBus Register		0x19 [3]	0x19 [2]	0x19 [1]	0x19 [0]	0x1C [5]	0x1C [4]	0x1C [3]	0x1C [2]
Default Value		00	0	0	0	0	0	0	0
Description	0x0F	ch2_BST_7	ch2_BST_6	ch2_BST_5	ch2_BST_4	ch2_BST_3	ch2_BST_2	ch2_BST_1	ch2_BST_0
SMBus Register		0x1D [7]	0x1D [6]	0x1D [5]	0x1D [4]	0x1D [3]	0x1D [2]	0x1D [1]	0x1D [0]
Default Value		2F	0	0	1	0	1	1	1
Description	0x10	ch2_Sel_scp	ch2_Sel_mode	ch2_RES_2	ch2_RES_1	ch2_RES_0	ch2_VOD_2	ch2_VOD_1	ch2_VOD_0
SMBus Register		0x1E [7]	0x1E [6]	0x1E [5]	0x1E [4]	0x1E [3]	0x1E [2]	0x1E [1]	0x1E [0]
Default Value		AD	1	0	1	0	1	1	0
Description	0x11	ch2_DEM_2	ch2_DEM_1	ch2_DEM_0	ch2_Slow	ch2_idle_tha_1	ch2_idle_tha_0	ch2_idle_thd_1	ch2_idle_thd_0
SMBus Register		0x1F [2]	0x1F [1]	0x1F [0]	0x20 [7]	0x20 [3]	0x20 [2]	0x20 [1]	0x20 [0]
Default Value		40	0	1	0	0	0	0	0
Description	0x12	ch3_idle_auto	ch3_Idle_sel	ch3_RXDET_1	ch3_RXDET_0	ch3_BST_7	ch3_BST_6	ch3_BST_5	ch3_BST_4
SMBus Register		0x23 [5]	0x23 [4]	0x23 [3]	0x23 [2]	0x24 [7]	0x24 [6]	0x24 [5]	0x24 [4]
Default Value		02	0	0	0	0	0	0	1
Description	0x13	ch3_BST_3	ch3_BST_2	ch3_BST_1	ch3_BST_0	ch3_Sel_scp	ch3_Sel_mode	ch3_RES_2	ch3_RES_1
SMBus Register		0x24 [3]	0x24 [2]	0x24 [1]	0x24 [0]	0x25 [7]	0x25 [6]	0x25 [5]	0x25 [4]
Default Value		FA	1	1	1	1	1	0	1
Description	0x14	ch3_RES_0	ch3_VOD_2	ch3_VOD_1	ch3_VOD_0	ch3_DEM_2	ch3_DEM_1	ch3_DEM_0	ch3_Slow
SMBus Register		0x25 [3]	0x25 [2]	0x25 [1]	0x25 [0]	0x26 [2]	0x26 [1]	0x26 [0]	0x27 [7]
Default Value		D4	1	1	0	1	0	1	0
Description	0x15	ch3_idle_tha_1	ch3_idle_tha_0	ch3_idle_thd_1	ch3_idle_thd_0	ovrd_fast_idle	en_high_idle_th_n	en_high_idle_th_s	en_fast_idle_n
SMBus Register		0x27 [3]	0x27 [2]	0x27 [1]	0x27 [0]	0x28 [6]	0x28 [5]	0x28 [4]	0x28 [3]
Default Value		09	0	0	0	0	0	0	0

Table 7. EEPROM Register Map - Single Device with Default Value (continued)

EEPROM Address Byte		Bit 7	Bit 6	Bit 5	Bit 4	Bit 3	Bit 2	Bit 1	Bit 0
Description	0x16	en_fast_idle_s	eqsd_mgain_n	eqsd_mgain_s	ch4_idle_auto	ch4_idle_sel	ch4_RXDET_1	ch4_RXDET_0	ch4_BST_7
SMBus Register		0x28 [2]	0x28 [1]	0x28 [0]	0x2B [5]	0x2B [4]	0x2B [3]	0x2B [2]	0x2C [7]
Default Value		80	1	0	0	0	0	0	0
Description	0x17	ch4_BST_6	ch4_BST_5	ch4_BST_4	ch4_BST_3	ch4_BST_2	ch4_BST_1	ch4_BST_0	ch4_Sel_scp
SMBus Register		0x2C [6]	0x2C [5]	0x2C [4]	0x2C [3]	0x2C [2]	0x2C [1]	0x2C [0]	0x2D [7]
Default Value		5F	0	1	0	1	1	1	1
Description	0x18	ch4_Sel_mode	ch4_RES_2	ch4_RES_1	ch4_RES_0	ch4_VOD_2	ch4_VOD_1	ch4_VOD_0	ch4_DEM_2
SMBus Register		0x2D [6]	0x2D [5]	0x2D [4]	0x2D [3]	0x2D [2]	0x2D [1]	0x2D [0]	0x2E [2]
Default Value		5A	0	1	0	1	1	0	1
Description	0x19	ch4_DEM_1	ch4_DEM_0	ch4_Slow	ch4_idle_tha_1	ch4_idle_tha_0	ch4_idle_thd_1	ch4_idle_thd_0	ch5_idle_auto
SMBus Register		0x2E [1]	0x2E [0]	0x2F [7]	0x2F [3]	0x2F [2]	0x2F [1]	0x2F [0]	0x32 [5]
Default Value		80	1	0	0	0	0	0	0
Description	0x1A	ch5_idle_sel	ch5_RXDET_1	ch5_RXDET_0	ch5_BST_7	ch5_BST_6	ch5_BST_5	ch5_BST_4	ch5_BST_3
SMBus Register		0x32 [4]	0x32 [3]	0x32 [2]	0x33 [7]	0x33 [6]	0x33 [5]	0x33 [4]	0x33 [3]
Default Value		05	0	0	0	0	1	0	1
Description	0x1B	ch5_BST_2	ch5_BST_1	ch5_BST_0	ch5_Sel_scp	ch5_Sel_mode	ch5_RES_2	ch5_RES_1	ch5_RES_0
SMBus Register		0x33 [2]	0x33 [1]	0x33 [0]	0x34 [7]	0x34 [6]	0x34 [5]	0x34 [4]	0x34 [3]
Default Value		F5	1	1	1	1	0	1	0
Description	0x1C	ch5_VOD_2	ch5_VOD_1	ch5_VOD_0	ch5_DEM_2	ch5_DEM_1	ch5_DEM_0	ch5_Slow	ch5_idle_tha_1
SMBus Register		0x34 [2]	0x34 [1]	0x34 [0]	0x35 [2]	0x35 [1]	0x35 [0]	0x36 [7]	0x36 [3]
Default Value		A8	1	0	1	0	1	0	0
Description	0x1D	ch5_idle_tha_0	ch5_idle_thd_1	ch5_idle_thd_0	ch6_idle_auto	ch6_idle_sel	ch6_RXDET_1	ch6_RXDET_0	ch6_BST_7
SMBus Register		0x36 [2]	0x36 [1]	0x36 [0]	0x39 [5]	0x39 [4]	0x39 [3]	0x39 [2]	0x3A [7]
Default Value		00	0	0	0	0	0	0	0
Description	0x1E	ch6_BST_6	ch6_BST_5	ch6_BST_4	ch6_BST_3	ch6_BST_2	ch6_BST_1	ch6_BST_0	ch6_Sel_scp
SMBus Register		0x3A [6]	0x3A [5]	0x3A [4]	0x3A [3]	0x3A [2]	0x3A [1]	0x3A [0]	0x3B [7]
Default Value		5F	0	1	0	1	1	1	1
Description	0x1F	ch6_Sel_mode	ch6_RES_2	ch6_RES_1	ch6_RES_0	ch6_VOD_2	ch6_VOD_1	ch6_VOD_0	ch6_DEM_2
SMBus Register		0x3B [6]	0x3B [5]	0x3B [4]	0x3B [3]	0x3B [2]	0x3B [1]	0x3B [0]	0x3C [2]
Default Value		5A	0	1	0	1	1	0	1
Description	0x20	ch6_DEM_1	ch6_DEM_0	ch6_Slow	ch6_idle_tha_1	ch6_idle_tha_0	ch6_idle_thd_1	ch6_idle_thd_0	ch7_idle_auto
SMBus Register		0x3C [1]	0x3C [0]	0x3D [7]	0x3D [3]	0x3D [2]	0x3D [1]	0x3D [0]	0x40 [5]
Default Value		80	1	0	0	0	0	0	0

Table 7. EEPROM Register Map - Single Device with Default Value (continued)

EEPROM Address Byte		Bit 7	Bit 6	Bit 5	Bit 4	Bit 3	Bit 2	Bit 1	Bit 0
Description	0x21	ch7_idle_sel	ch7_RXDET_1	ch7_RXDET_0	ch7_BST_7	ch7_BST_6	ch7_BST_5	ch7_BST_4	ch7_BST_3
SMBus Register		0x40 [4]	0x40 [3]	0x40 [2]	0x41 [7]	0x41 [6]	0x41 [5]	0x41 [4]	0x41 [3]
Default Value		05	0	0	0	0	0	1	0
Description	0x22	ch7_BST_2	ch7_BST_1	ch7_BST_0	ch7_Sel_scp	ch7_Sel_mode	ch7_RES_2	ch7_RES_1	ch7_RES_0
SMBus Register		0x41 [2]	0x41 [1]	0x41 [0]	0x42 [7]	0x42 [6]	0x42 [5]	0x42 [4]	0x42 [3]
Default Value		F5	1	1	1	1	0	1	0
Description	0x23	ch7_VOD_2	ch7_VOD_1	ch7_VOD_0	ch7_DEM_2	ch7_DEM_1	ch7_DEM_0	ch7_Slow	ch7_idle_tha_1
SMBus Register		0x42 [2]	0x42 [1]	0x42 [0]	0x43 [2]	0x43 [1]	0x43 [0]	0x44 [7]	0x44 [3]
Default Value		A8	1	0	1	0	1	0	0
Description	0x24	ch7_idle_tha_0	ch7_idle_thd_1	ch7_idle_thd_0	Reserved	Reserved	Reserved	Reserved	Reserved
SMBus Register		0x44 [2]	0x44 [1]	0x44 [0]	0x47 [3]	0x47 [2]	0x47 [2]	0x47 [0]	0x48 [7]
Default Value		00	0	0	0	0	0	0	0
Description	0x25	Reserved	Reserved	Reserved	Reserved	Reserved	Reserved	Reserved	Reserved
SMBus Register		0x48 [6]	0x4C [7]	0x4C [6]	0x4C [5]	0x4C [4]	0x4C [3]	0x4C [0]	0x59 [0]
Default Value		00	0	0	0	0	0	0	0
Description	0x26	Reserved	Reserved	Reserved	Reserved	Reserved	Reserved	Reserved	Reserved
SMBus Register		0x5A [7]	0x5A [6]	0x5A [5]	0x5A [4]	0x5A [3]	0x5A [2]	0x5A [1]	0x5A [0]
Default Value		54	0	1	0	1	0	1	0
Description	0x27	Reserved	Reserved	Reserved	Reserved	Reserved	Reserved	Reserved	Reserved
SMBus Register		0x5B [7]	0x5B [6]	0x5B [5]	0x5B [4]	0x5B [3]	0x5B [2]	0x5B [1]	0x5B [0]
Default Value		54	0	1	0	1	0	1	0

Table 8. Example of EEPROM for Four Devices Using Two Address Maps

EEPROM Address	Address (Hex)	EEPROM Data	Comments
0	00	0x43	CRC_EN = 0, Address Map = 1, >256 bytes = 0, Device Count[3:0] = 3
1	01	0x00	
2	02	0x08	EEPROM Burst Size
3	03	0x00	CRC not used
4	04	0x0B	Device 0 Address Location
5	05	0x00	CRC not used
6	06	0x0B	Device 1 Address Location
7	07	0x00	CRC not used
8	08	0x30	Device 2 Address Location
9	09	0x00	CRC not used
10	0A	0x30	Device 3 Address Location
11	0B	0x00	Begin Device 0, 1 - Address Offset 3
12	0C	0x00	
13	0D	0x04	
14	0E	0x07	
15	0F	0x00	
16	10	0x00	EQ CHB0 = 00
17	11	0xAB	VOD CHB0 = 1.0 V
18	12	0x00	DEM CHB0 = 0 (0 dB)
19	13	0x00	EQ CHB1 = 00
20	14	0x0A	VOD CHB1 = 1.0 V
21	15	0xB0	DEM CHB1 = 0 (0 dB)
22	16	0x00	
23	17	0x00	EQ CHB2 = 00
24	18	0xAB	VOD CHB2 = 1.0 V
25	19	0x00	DEM CHB2 = 0 (0 dB)
26	1A	0x00	EQ CHB3 = 00
27	1B	0x0A	VOD CHB3 = 1.0 V
28	1C	0xB0	DEM CHB3 = 0 (0 dB)
29	1D	0x01	
30	1E	0x80	
31	1F	0x01	EQ CHA0 = 00
32	20	0x56	VOD CHA0 = 1.0 V
33	21	0x00	DEM CHA0 = 0 (0 dB)
34	22	0x00	EQ CHA1 = 00
35	23	0x15	VOD CHA1 = 1.0 V
36	24	0x60	DEM CHA1 = 0 (0 dB)
37	25	0x00	
38	26	0x01	EQ CHA2 = 00
39	27	0x56	VOD CHA2 = 1.0 V
40	28	0x00	DEM CHA2 = 0 (0 dB)
41	29	0x00	EQ CHA3 = 00
42	2A	0x15	VOD CHA3 = 1.0 V
43	2B	0x60	DEM CHA3 = 0 (0 dB)
44	2C	0x00	
45	2D	0x00	
46	2E	0x54	

Table 8. Example of EEPROM for Four Devices Using Two Address Maps (continued)

EEPROM Address	Address (Hex)	EEPROM Data	Comments
47	2F	0x54	End Device 0, 1 - Address Offset 39
48	30	0x00	Begin Device 2, 3 - Address Offset 3
49	31	0x00	
50	32	0x04	
51	33	0x07	
52	34	0x00	
53	35	0x00	EQ CHB0 = 00
54	36	0xAB	VOD CHB0 = 1.0 V
55	37	0x00	DEM CHB0 = 0 (0 dB)
56	38	0x00	EQ CHB1 = 00
57	39	0x0A	VOD CHB1 = 1.0 V
58	3A	0xB0	DEM CHB1 = 0 (0 dB)
59	3B	0x00	
60	3C	0x00	EQ CHB2 = 00
61	3D	0xAB	VOD CHB2 = 1.0 V
62	3E	0x00	DEM CHB2 = 0 (0 dB)
63	3F	0x00	EQ CHB3 = 00
64	40	0x0A	VOD CHB3 = 1.0 V
65	41	0xB0	DEM CHB3 = 0 (0 dB)
66	42	0x01	
67	43	0x80	
68	44	0x01	EQ CHA0 = 00
69	45	0x56	VOD CHA0 = 1.0 V
70	46	0x00	DEM CHA0 = 0 (0 dB)
71	47	0x00	EQ CHA1 = 00
72	48	0x15	VOD CHA1 = 1.0 V
73	49	0x60	DEM CHA1 = 0 (0 dB)
74	4A	0x00	
75	4B	0x01	EQ CHA2 = 00
76	4C	0x56	VOD CHA2 = 1.0 V
77	4D	0x00	DEM CHA2 = 0 (0 dB)
78	4E	0x00	EQ CHA3 = 00
79	4F	0x15	VOD CHA3 = 1.0 V
80	50	0x60	DEM CHA3 = 0 (0 dB)
81	51	0x00	
82	52	0x00	
83	53	0x54	
84	54	0x54	End Device 2, 3 - Address Offset 39

NOTE: CRC_EN = 0, Address Map = 1, >256 byte = 0, Device Count[3:0] = 3. This example has all 8 channels set to EQ = 00 (min boost), VOD = 1.0 V, DEM = 0 (0 dB) and multiple device can point to the same address map. Maximum EEPROM size is 8kbits (1024 x 8-bits).

8.5.2 Transfer of Data Via the SMBus

During normal operation the data on SDA must be stable during the time when SCL is High.

There are three unique states for the SMBus:

START: A High-to-Low transition on SDA while SCL is High indicates a message START condition.

STOP: A Low-to-High transition on SDA while SCL is High indicates a message STOP condition.

IDLE: If SCL and SDA are both High for a time exceeding t_{BUF} from the last detected STOP condition or if they are High for a total exceeding the maximum specification for t_{HIGH} then the bus will transfer to the IDLE state.

8.5.3 System Management Bus (SMBus) and Configuration Registers

The System Management Bus interface is compatible to SMBus 2.0 physical layer specification. $ENSMB = 1\text{ k}\Omega$ to VDD to enable SMBus slave mode and allow access to the configuration registers.

The DS125BR800 has the AD[3:0] inputs in SMBus mode. These pins are the user set SMBUS slave address inputs. The AD[3:0] pins have internal pull-down. When left floating or pulled low the AD[3:0] = 0000'b, the device default address byte is 0xB0. Based on the SMBus 2.0 specification, the DS125BR800 has a 7-bit slave address. The LSB is set to 0'b (for a WRITE). The device supports up to 16 address byte, which can be set with the AD[3:0] inputs. [Table 9](#) shows the 16 addresses.

Table 9. Device Slave Address Bytes

AD[3:0] Settings	Address Bytes (HEX)
0000	B0
0001	B2
0010	B4
0011	B6
0100	B8
0101	BA
0110	BC
0111	BE
1000	C0
1001	C2
1010	C4
1011	C6
1100	C8
1101	CA
1110	CC
1111	CE

The SDA, SCL pins are 3.3 V tolerant, but are not 5 V tolerant. External pull-up resistor is required on the SDA. The resistor value can be from 1 k Ω to 5 k Ω depending on the voltage, loading and speed. The SCL may also require an external pull-up resistor and it depends on the Host that drives the bus.

8.5.4 SMBus Transactions

The device supports WRITE and READ transactions. See [Table 10](#) for register address, type (Read/Write, Read Only), default value and function information.

8.5.5 Writing a Register

To write a register, the following protocol is used (see SMBus 2.0 specification).

1. The Host drives a START condition, the 7-bit SMBus address, and a "0" indicating a WRITE.
2. The Device (Slave) drives the ACK bit ("0").
3. The Host drives the 8-bit Register Address.
4. The Device drives an ACK bit ("0").
5. The Host drive the 8-bit data byte.
6. The Device drives an ACK bit ("0").
7. The Host drives a STOP condition.

The WRITE transaction is completed, the bus goes IDLE and communication with other SMBus devices may now occur.

8.5.6 Reading a Register

To read a register, the following protocol is used (see SMBus 2.0 specification).

1. The Host drives a START condition, the 7-bit SMBus address, and a "0" indicating a WRITE.
2. The Device (Slave) drives the ACK bit ("0").
3. The Host drives the 8-bit Register Address.
4. The Device drives an ACK bit ("0").
5. The Host drives a START condition.
6. The Host drives the 7-bit SMBus Address, and a "1" indicating a READ.
7. The Device drives an ACK bit "0".
8. The Device drives the 8-bit data value (register contents).
9. The Host drives a NACK bit "1" indicating end of the READ transfer.
10. The Host drives a STOP condition.

The READ transaction is completed, the bus goes IDLE and communication with other SMBus devices may now occur.

8.6 Register Maps

Table 10. SMBUS Slave Mode Register Map

Address	Register Name	Bit	Field	Type	Default	EEPROM Bit	Description	
0x00	Device Address Observation	7	Reserved	R/W	0x00		Set bit to 0.	
		6:3	Address Bit AD[3:0]	R			Observation of AD[3:0] bit [6]: AD3 [5]: AD2 [4]: AD1 [3]: AD0	
		2	EEPROM Read Done	R			1: Device completed the read from external EEPROM.	
		1:0	Reserved	R/W			Set bits to 0.	
0x01	PWDN Channels	7:0	PWDN CHx	R/W	0x00	Yes	Power Down per Channel [7]: CH7 – CHA_3 [6]: CH6 – CHA_2 [5]: CH5 – CHA_1 [4]: CH4 – CHA_0 [3]: CH3 – CHB_3 [2]: CH2 – CHB_2 [1]: CH1 – CHB_1 [0]: CH0 – CHB_0 0x00 = all channels enabled 0xFF = all channels disabled Note: override PWDN pin.	
0x02	Override PWDN Control	7:1	Reserved	R/W	0x00		Set bits to 0.	
		0	Override PWDN				Yes	1: Block PWDN pin control 0: Allow PWDN pin control
0x03	Reserved	7:0	Reserved	R/W	0x00		Set bits to 0	
0x04	Reserved	7:0	Reserved	R/W	0x00	Yes	Set bits to 0	
0x05	Reserved	7:0	Reserved	R/W	0x00		Set bits to 0	
0x05	Reserved	7:0	Reserved	R/W	0x00		Reserved	
0x06	Slave Register Control	7:5	Reserved	R/W	0x10		Set bits to 0.	
		4	Reserved				Yes	Set bit to 1.
		3	Register Enable					1 = Enable SMBus Register Control 0 = Disable SMBus Register Control Note: In order to change VOD, DEM, and EQ of the channels in slave mode, this bit must be set to 1.
		2:0	Reserved					Set bits to 0.
0x07	Digital Reset and Control	7	Reserved	R/W	0x01		Set bit to 0.	
		6	Reset Registers				Self clearing bit, set to 1 to reset the register to default values	
		5	Reset SMBus Master				Self clearing reset to SMBus master state machine	
		4:0	Reserved				Set bits to 0 0001'b.	

Register Maps (continued)
Table 10. SMBUS Slave Mode Register Map (continued)

Address	Register Name	Bit	Field	Type	Default	EEPROM Bit	Description
0x08	Override Pin Control	7	Reserved	R/W	0x00		Set bit to 0.
		6	Override SD_TH			Yes	1: Block SD_TH pin control 0: Allow SD_TH pin control
		5	Reserved			Yes	Set bit to 0.
		4	Override IDLE			Yes	1: IDLE control by registers 0: IDLE control by signal detect
		3	Override RXDET			Yes	1: Block RXDET pin control 0: Allow RXDET pin control
		2	Override MODE			Yes	1: Block MODE pin control 0: Allow MODE pin control
		1	Reserved				Set bit to 0.
		0	Reserved				Set bit to 0.
0x09	Reserved	7:0	Reserved	R/W	0x00		Set bits to 0
0x0A	Signal Detect Monitor	7:0	SD_TH Status	R	0x00		CH7 - CH0 Internal Signal Detector Indicator [7]: CH7 - CHA_3 [6]: CH6 - CHA_2 [5]: CH5 - CHA_1 [4]: CH4 - CHA_0 [3]: CH3 - CHB_3 [2]: CH2 - CHB_2 [1]: CH1 - CHB_1 [0]: CH0 - CHB_0 0 = Signal detected at input (active data) 1 = Signal not detected at input (idle state) NOTE: These bits only function when RATE pin = FLOAT
0x0B	Reserved	7	Reserved	R/W	0x00		Set bits to 0
		6:0	Reserved	R/W	0x70	Yes	Set bits to 111 0000'b
0x0C	Reserved	7:0	Reserved	R/W	0x00		Set bits to 0
0x0D	CH0 - CHB0 Signal Detect	7:3	Reserved	R/W	0x00		Set bits to 0.
		2	SD Reset				1: Force signal detect "off" 0: Normal operation
		1	SD Preset				1: Force signal detect "on" 0: Normal operation
		0	Reserved				Set bit to 0.

Register Maps (continued)
Table 10. SMBUS Slave Mode Register Map (continued)

Address	Register Name	Bit	Field	Type	Default	EEPROM Bit	Description
0x0E	CH0 - CHB0 IDLE, RXDET	7:6	Reserved	R/W	0x00		Set bits to 0.
		5	IDLE_AUTO			Yes	1 = Allow IDLE_SEL control in bit 4 0 = Automatic IDLE detect Note: override IDLE control.
		4	IDLE_SEL			Yes	1: Output is MUTED (electrical idle) 0: Output is ON Note: override IDLE control.
		3:2	RXDET			Yes	00: Input is high-z impedance 01: Auto RX-Detect, outputs test every 12 ms for 600 ms (50 times) then stops; termination is high-z until detection; once detected input termination is 50 Ω 10: Auto RX-Detect, outputs test every 12 ms until detection occurs; termination is high-z until detection; once detected input termination is 50 Ω 11: Input is 50 Ω Note: override RXDET pin.
		1:0	Reserved				Set bits to 0.
0x0F	CH0 - CHB0 EQ	7:0	EQ Control	R/W	0x2F	Yes	IB0 EQ Control - total of 256 levels. See Table 2 .
0x10	CH0 - CHB0 VOD	7	Short Circuit Protection	R/W	0xAD	Yes	1: Enable the short circuit protection 0: Disable the short circuit protection
		6	MODE_SEL			Yes	1: PCIe Gen-1 or PCIe Gen-2 0: PCIe Gen-3 Note: override the MODE pin.
		5:3	Reserved			Yes	Set bits to default value - 101.
		2:0	VOD Control			Yes	OB0 VOD Control 000: 0.7 V 001: 0.8 V 010: 0.9 V 011: 1.0 V 100: 1.1 V 101: 1.2 V (default) 110: 1.3 V 111: 1.4 V

Register Maps (continued)
Table 10. SMBUS Slave Mode Register Map (continued)

Address	Register Name	Bit	Field	Type	Default	EEPROM Bit	Description
0x11	CH0 - CHB0 DEM	7	RXDET STATUS	R	0x02		Observation bit for RXDET CH0 - CHB0. 1: RX = detected 0: RX = not detected
		6:5	MODE_DET STATUS	R			Observation bit for MODE_DET CH0 - CHB0. 00: PCIe Gen-1 (2.5G) 01: PCIe Gen-2 (5G) 11: PCIe Gen-3 (8G+) Note: Only functions when MODE Pin = Automatic
		4:3	Reserved	R/W			Set bits to 0.
		2:0	DEM Control	R/W		Yes	OB0 DEM Control 000: 0 dB 001: -1.5 dB 010: -3.5 dB (default) 011: -5 dB 100: -6 dB 101: -8 dB 110: -9 dB 111: -12 dB
0x12	CH0 - CHB0 IDLE Threshold	7:4	Reserved	R/W	0x00		Set bits to 0.
		3:2	IDLE tha			Yes	Assert threshold 00 = 180 mVp-p (default) 01 = 160 mVp-p 10 = 210 mVp-p 11 = 190 mVp-p Note: override the SD_TH pin.
		1:0	IDLE thd			Yes	De-Assert threshold 00 = 110 mVp-p (default) 01 = 100 mVp-p 10 = 150 mVp-p 11 = 130 mVp-p Note: override the SD_TH pin.
0x13	Reserved	7:0	Reserved	R/W	0x00		Set bits to 0
0x14	CH1 - CHB1 Signal Detect	7:3	Reserved	R/W	0x00		Set bits to 0.
		2	SD Reset				1: Force signal detect "off" 0: Normal operation
		1	SD Preset				1: Force signal detect "on" 0: Normal operation
		0	Reserved				Set bit to 0.

Register Maps (continued)
Table 10. SMBUS Slave Mode Register Map (continued)

Address	Register Name	Bit	Field	Type	Default	EEPROM Bit	Description
0x15	CH1 - CHB1 IDLE, RXDET	7:6	Reserved	R/W	0x00		Set bits to 0.
		5	IDLE_AUTO			Yes	1 = Allow IDLE_SEL control in bit 4 0 = Automatic IDLE detect Note: override IDLE control.
		4	IDLE_SEL			Yes	1: Output is MUTED (electrical idle) 0: Output is ON Note: override IDLE control.
		3:2	RXDET			Yes	00: Input is high-z impedance 01: Auto RX-Detect, outputs test every 12 ms for 600 ms (50 times) then stops; termination is high-z until detection; once detected input termination is 50 Ω 10: Auto RX-Detect, outputs test every 12 ms until detection occurs; termination is high-z until detection; once detected input termination is 50 Ω 11: Input is 50 Ω Note: override RXDET pin.
		1:0	Reserved				Set bits to 0.
0x16	CH1 - CHB1 EQ	7:0	EQ Control	R/W	0x2F	Yes	IB1 EQ Control - total of 256 levels. See Table 2 .
0x17	CH1 - CHB1 VOD	7	Short Circuit Protection	R/W	0xAD	Yes	1: Enable the short circuit protection 0: Disable the short circuit protection
		6	MODE_SEL			Yes	1: PCIe Gen-1 or PCIe Gen-2 0: PCIe Gen-3 Note: override the MODE pin.
		5:3	Reserved			Yes	Set bits to default value - 101.
		2:0	VOD Control			Yes	OB1 VOD Control 000: 0.7 V 001: 0.8 V 010: 0.9 V 011: 1.0 V 100: 1.1 V 101: 1.2 V (default) 110: 1.3 V 111: 1.4 V

Register Maps (continued)
Table 10. SMBUS Slave Mode Register Map (continued)

Address	Register Name	Bit	Field	Type	Default	EEPROM Bit	Description
0x18	CH1 - CHB1 DEM	7	RXDET STATUS	R	0x02		Observation bit for RXDET CH1 - CHB1. 1: RX = detected 0: RX = not detected
		6:5	MODE_DET STATUS	R			Observation bit for MODE_DET CH1 - CHB1. 00: PCIe Gen-1 (2.5G) 01: PCIe Gen-2 (5G) 11: PCIe Gen-3 (8G+) Note: Only functions when MODE Pin = Automatic
		4:3	Reserved	R/W			Set bits to 0.
		2:0	DEM Control	R/W		Yes	OB1 DEM Control 000: 0 dB 001: -1.5 dB 010: -3.5 dB (default) 011: -5 dB 100: -6 dB 101: -8 dB 110: -9 dB 111: -12 dB
0x19	CH1 - CHB1 IDLE Threshold	7:4	Reserved	R/W	0x00		Set bits to 0.
		3:2	IDLE tha			Yes	Assert threshold 00 = 180 mVp-p (default) 01 = 160 mVp-p 10 = 210 mVp-p 11 = 190 mVp-p Note: override the SD_TH pin.
		1:0	IDLE thd			Yes	De-Assert threshold 00 = 110 mVp-p (default) 01 = 100 mVp-p 10 = 150 mVp-p 11 = 130 mVp-p Note: override the SD_TH pin.
0x1A	Reserved	7:0	Reserved	R/W	0x00		Set bits to 0
0x1B	CH2 - CHB2 Signal Detect	7:3	Reserved	R/W	0x00		Set bits to 0.
		2	SD Reset				1: Force signal detect "off" 0: Normal operation
		1	SD Preset				1: Force signal detect "on" 0: Normal operation
		0	Reserved				Set bit to 0.

Register Maps (continued)
Table 10. SMBUS Slave Mode Register Map (continued)

Address	Register Name	Bit	Field	Type	Default	EEPROM Bit	Description
0x1C	CH2 - CHB2 IDLE, RXDET	7:6	Reserved	R/W	0x00		Set bits to 0.
		5	IDLE_AUTO			Yes	1 = Allow IDLE_SEL control in bit 4 0 = Automatic IDLE detect Note: override IDLE control.
		4	IDLE_SEL			Yes	1: Output is MUTED (electrical idle) 0: Output is ON Note: override IDLE control.
		3:2	RXDET			Yes	00: Input is high-z impedance 01: Auto RX-Detect, outputs test every 12 ms for 600 ms (50 times) then stops; termination is high-z until detection; once detected input termination is 50 Ω 10: Auto RX-Detect, outputs test every 12 ms until detection occurs; termination is high-z until detection; once detected input termination is 50 Ω 11: Input is 50 Ω Note: override RXDET pin.
		1:0	Reserved				Set bits to 0.
0x1D	CH2 - CHB2 EQ	7:0	EQ Control	R/W	0x2F	Yes	IB2 EQ Control - total of 256 levels. See Table 2 .
0x1E	CH2 - CHB2 VOD	7	Short Circuit Protection	R/W	0xAD	Yes	1: Enable the short circuit protection 0: Disable the short circuit protection
		6	MODE_SEL			Yes	1: PCIe Gen-1 or PCIe Gen-2 0: PCIe Gen-3 Note: override the MODE pin.
		5:3	Reserved			Yes	Set bits to default value - 101.
		2:0	VOD Control			Yes	OB2 VOD Control 000: 0.7 V 001: 0.8 V 010: 0.9 V 011: 1.0 V 100: 1.1 V 101: 1.2 V (default) 110: 1.3 V 111: 1.4 V

Register Maps (continued)
Table 10. SMBUS Slave Mode Register Map (continued)

Address	Register Name	Bit	Field	Type	Default	EEPROM Bit	Description
0x1F	CH2 - CHB2 DEM	7	RXDET STATUS	R	0x02		Observation bit for RXDET CH2 - CHB2. 1: RX = detected 0: RX = not detected
		6:5	MODE_DET STATUS	R			Observation bit for MODE_DET CH2 - CHB2. 00: PCIe Gen-1 (2.5G) 01: PCIe Gen-2 (5G) 11: PCIe Gen-3 (8G+) Note: Only functions when MODE Pin = Automatic
		4:3	Reserved	R/W			Set bits to 0.
		2:0	DEM Control	R/W		Yes	OB2 DEM Control 000: 0 dB 001: -1.5 dB 010: -3.5 dB (default) 011: -5 dB 100: -6 dB 101: -8 dB 110: -9 dB 111: -12 dB
0x20	CH2 - CHB2 IDLE Threshold	7:4	Reserved	R/W	0x00		Set bits to 0.
		3:2	IDLE tha			Yes	Assert threshold 00 = 180 mVp-p (default) 01 = 160 mVp-p 10 = 210 mVp-p 11 = 190 mVp-p Note: override the SD_TH pin.
		1:0	IDLE thd			Yes	De-Assert threshold 00 = 110 mVp-p (default) 01 = 100 mVp-p 10 = 150 mVp-p 11 = 130 mVp-p Note: override the SD_TH pin.
0x21	Reserved	7:0	Reserved	R/W	0x00		Set bits to 0
0x22	CH3 - CHB3 Signal Detect	7:3	Reserved	R/W	0x00		Set bits to 0.
		2	SD Reset				1: Force signal detect "off" 0: Normal operation
		1	SD Preset				1: Force signal detect "on" 0: Normal operation
		0	Reserved				Set bit to 0.

Register Maps (continued)
Table 10. SMBUS Slave Mode Register Map (continued)

Address	Register Name	Bit	Field	Type	Default	EEPROM Bit	Description
0x23	CH3 - CHB3 IDLE, RXDET	7:6	Reserved	R/W	0x00		Set bits to 0.
		5	IDLE_AUTO			Yes	1 = Allow IDLE_SEL control in bit 4 0 = Automatic IDLE detect Note: override IDLE control.
		4	IDLE_SEL			Yes	1: Output is MUTED (electrical idle) 0: Output is ON Note: override IDLE control.
		3:2	RXDET			Yes	00: Input is high-z impedance 01: Auto RX-Detect, outputs test every 12 ms for 600 ms (50 times) then stops; termination is high-z until detection; once detected input termination is 50 Ω 10: Auto RX-Detect, outputs test every 12 ms until detection occurs; termination is high-z until detection; once detected input termination is 50 Ω 11: Input is 50 Ω Note: override RXDET pin.
		1:0	Reserved				Set bits to 0.
0x24	CH3 - CHB3 EQ	7:0	EQ Control	R/W	0x2F	Yes	IB3 EQ Control - total of 256 levels. See Table 2 .
0x25	CH3 - CHB3 VOD	7	Short Circuit Protection	R/W	0xAD	Yes	1: Enable the short circuit protection 0: Disable the short circuit protection
		6	MODE_SEL			Yes	1: PCIe Gen-1 or PCIe Gen-2 0: PCIe Gen-3 Note: override the MODE pin.
		5:3	Reserved			Yes	Set bits to default value - 101.
		2:0	VOD Control			Yes	OB0 VOD Control 000: 0.7 V 001: 0.8 V 010: 0.9 V 011: 1.0 V 100: 1.1 V 101: 1.2 V (default) 110: 1.3 V 111: 1.4 V

Register Maps (continued)
Table 10. SMBUS Slave Mode Register Map (continued)

Address	Register Name	Bit	Field	Type	Default	EEPROM Bit	Description
0x26	CH3 - CHB3 DEM	7	RXDET STATUS	R	0x02		Observation bit for RXDET CH3 - CHB3. 1: RX = detected 0: RX = not detected
		6:5	MODE_DET STATUS	R			Observation bit for MODE_DET CH3 - CHB3. 00: PCIe Gen-1 (2.5G) 01: PCIe Gen-2 (5G) 11: PCIe Gen-3 (8G+) Note: Only functions when MODE Pin = Automatic
		4:3	Reserved	R/W			Set bits to 0.
		2:0	DEM Control	R/W		Yes	OB3 DEM Control 000: 0 dB 001: -1.5 dB 010: -3.5 dB (default) 011: -5 dB 100: -6 dB 101: -8 dB 110: -9 dB 111: -12 dB
0x27	CH3 - CHB3 IDLE Threshold	7:4	Reserved	R/W	0x00		Set bits to 0.
		3:2	IDLE tha			Yes	Assert threshold 00 = 180 mVp-p (default) 01 = 160 mVp-p 10 = 210 mVp-p 11 = 190 mVp-p Note: override the SD_TH pin.
		1:0	IDLE thd			Yes	De-Assert threshold 00 = 110 mVp-p (default) 01 = 100 mVp-p 10 = 150 mVp-p 11 = 130 mVp-p Note: override the SD_TH pin.
0x28	Signal Detect Control	7:6	Reserved	R/W	0x0C		Set bits to 0.
		5:4	High IDLE			Yes	Enable higher range of Signal Detect Thresholds [5]: CH0 - CH3 [4]: CH4 -CH7
		3:2	Fast IDLE			Yes	Enable Fast OOB response [3]: CH0 - CH3 [2]: CH4 -CH7
		1:0	Reduced SD Gain			Yes	Enable reduced Signal Detect Gain [1]: CH0 - CH3 [0]: CH4 -CH7
0x29	Reserved	7:0	Reserved	R/W	0x00		Set bits to 0

Register Maps (continued)
Table 10. SMBUS Slave Mode Register Map (continued)

Address	Register Name	Bit	Field	Type	Default	EEPROM Bit	Description
0x2A	CH4 - CHA0 Signal Detect	7:3	Reserved	R/W	0x00		Set bits to 0.
		2	SD Reset				1: Force signal detect "off" 0: Normal operation
		1	SD Preset				1: Force signal detect "on" 0: Normal operation
		0	Reserved				Set bit to 0.
0x2B	CH4 - CHA0 IDLE, RXDET	7:6	Reserved	R/W	0x00		Set bits to 0.
		5	IDLE_AUTO			Yes	1 = Allow IDLE_SEL control in bit 4 0 = Automatic IDLE detect Note: override IDLE control.
		4	IDLE_SEL			Yes	1: Output is MUTED (electrical idle) 0: Output is ON Note: override IDLE control.
		3:2	RXDET			Yes	00: Input is high-z impedance 01: Auto RX-Detect, outputs test every 12 ms for 600 ms (50 times) then stops; termination is high-z until detection; once detected input termination is 50 Ω 10: Auto RX-Detect, outputs test every 12 ms until detection occurs; termination is high-z until detection; once detected input termination is 50 Ω 11: Input is 50 Ω Note: override RXDET pin.
		1:0	Reserved				Set bits to 0.
0x2C	CH4 - CHA0 EQ	7:0	EQ Control	R/W	0x2F	Yes	IA0 EQ Control - total of 256 levels. See Table 2 .
0x2D	CH4 - CHA0 VOD	7	Short Circuit Protection	R/W	0xAD	Yes	1: Enable the short circuit protection 0: Disable the short circuit protection
		6	MODE_SEL			Yes	1: PCIe Gen-1 or PCIe Gen-2 0: PCIe Gen-3 Note: override the MODE pin.
		5:3	Reserved			Yes	Set bits to default value - 101.
		2:0	VOD Control			Yes	OA0 VOD Control 000: 0.7 V 001: 0.8 V 010: 0.9 V 011: 1.0 V 100: 1.1 V 101: 1.2 V (default) 110: 1.3 V 111: 1.4 V

Register Maps (continued)
Table 10. SMBUS Slave Mode Register Map (continued)

Address	Register Name	Bit	Field	Type	Default	EEPROM Bit	Description
0x2E	CH4 - CHA0 DEM	7	RXDET STATUS	R	0x02		Observation bit for RXDET CH4 - CHA0. 1: RX = detected 0: RX = not detected
		6:5	MODE_DET STATUS	R			Observation bit for MODE_DET CH4 - CHA0. 00: PCIe Gen-1 (2.5G) 01: PCIe Gen-2 (5G) 11: PCIe Gen-3 (8G+) Note: Only functions when MODE Pin = Automatic
		4:3	Reserved	R/W			Set bits to 0.
		2:0	DEM Control	R/W		Yes	OA0 DEM Control 000: 0 dB 001: -1.5 dB 010: -3.5 dB (default) 011: -5 dB 100: -6 dB 101: -8 dB 110: -9 dB 111: -12 dB
0x2F	CH4 - CHA0 IDLE Threshold	7:4	Reserved	R/W	0x00		Set bits to 0.
		3:2	IDLE tha			Yes	Assert threshold 00 = 180 mVp-p (default) 01 = 160 mVp-p 10 = 210 mVp-p 11 = 190 mVp-p Note: override the SD_TH pin.
		1:0	IDLE thd			Yes	De-Assert threshold 00 = 110 mVp-p (default) 01 = 100 mVp-p 10 = 150 mVp-p 11 = 130 mVp-p Note: override the SD_TH pin.
0x30	Reserved	7:0	Reserved	R/W	0x00		Set bits to 0
0x31	CH5 - CHA1 Signal Detect	7:3	Reserved	R/W	0x00		Set bits to 0.
		2	SD Reset				1: Force signal detect "off" 0: Normal operation
		1	SD Preset				1: Force signal detect "on" 0: Normal operation
		0	Reserved				Set bit to 0.

Register Maps (continued)
Table 10. SMBUS Slave Mode Register Map (continued)

Address	Register Name	Bit	Field	Type	Default	EEPROM Bit	Description
0x32	CH5 - CHA1 IDLE, RXDET	7:6	Reserved	R/W	0x00		Set bits to 0.
		5	IDLE_AUTO			Yes	1 = Allow IDLE_SEL control in bit 4 0 = Automatic IDLE detect Note: override IDLE control.
		4	IDLE_SEL			Yes	1: Output is MUTED (electrical idle) 0: Output is ON Note: override IDLE control.
		3:2	RXDET			Yes	00: Input is high-z impedance 01: Auto RX-Detect, outputs test every 12 ms for 600 ms (50 times) then stops; termination is high-z until detection; once detected input termination is 50 Ω 10: Auto RX-Detect, outputs test every 12 ms until detection occurs; termination is high-z until detection; once detected input termination is 50 Ω 11: Input is 50 Ω Note: override RXDET pin.
		1:0	Reserved				Set bits to 0.
0x33	CH5 - CHA1 EQ	7:0	EQ Control	R/W	0x2F	Yes	IA1 EQ Control - total of 256 levels. See Table 2 .
0x34	CH5 - CHA1 VOD	7	Short Circuit Protection	R/W	0xAD	Yes	1: Enable the short circuit protection 0: Disable the short circuit protection
		6	MODE_SEL			Yes	1: PCIe Gen-1 or PCIe Gen-2 0: PCIe Gen-3 Note: override the MODE pin.
		5:3	Reserved			Yes	Set bits to default value - 101.
		2:0	VOD Control			Yes	OA1 VOD Control 000: 0.7 V 001: 0.8 V 010: 0.9 V 011: 1.0 V 100: 1.1 V 101: 1.2 V (default) 110: 1.3 V 111: 1.4 V

Register Maps (continued)
Table 10. SMBUS Slave Mode Register Map (continued)

Address	Register Name	Bit	Field	Type	Default	EEPROM Bit	Description
0x35	CH5 - CHA1 DEM	7	RXDET STATUS	R	0x02		Observation bit for RXDET CH5 - CHA1. 1: RX = detected 0: RX = not detected
		6:5	MODE_DET STATUS	R			Observation bit for MODE_DET CH5 - CHA1. 00: PCIe Gen-1 (2.5G) 01: PCIe Gen-2 (5G) 11: PCIe Gen-3 (8G+) Note: Only functions when MODE Pin = Automatic
		4:3	Reserved	R/W			Set bits to 0.
		2:0	DEM Control	R/W		Yes	OA1 DEM Control 000: 0 dB 001: -1.5 dB 010: -3.5 dB (default) 011: -5 dB 100: -6 dB 101: -8 dB 110: -9 dB 111: -12 dB
0x36	CH5 - CHA1 IDLE Threshold	7:4	Reserved	R/W	0x00		Set bits to 0.
		3:2	IDLE tha			Yes	Assert threshold 00 = 180 mVp-p (default) 01 = 160 mVp-p 10 = 210 mVp-p 11 = 190 mVp-p Note: override the SD_TH pin.
		1:0	IDLE thd			Yes	De-Assert threshold 00 = 110 mVp-p (default) 01 = 100 mVp-p 10 = 150 mVp-p 11 = 130 mVp-p Note: override the SD_TH pin.
0x37	Reserved	7:0	Reserved	R/W	0x00		Set bits to 0
0x38	CH6 - CHA2 Signal Detect	7:3	Reserved	R/W	0x00		Set bits to 0.
		2	SD Reset				1: Force signal detect "off" 0: Normal operation
		1	SD Preset				1: Force signal detect "on" 0: Normal operation
		0	Reserved				Set bit to 0.

Register Maps (continued)
Table 10. SMBUS Slave Mode Register Map (continued)

Address	Register Name	Bit	Field	Type	Default	EEPROM Bit	Description
0x39	CH6 - CHA2 IDLE, RXDET	7:6	Reserved	R/W	0x00		Set bits to 0.
		5	IDLE_AUTO			Yes	1 = Allow IDLE_SEL control in bit 4 0 = Automatic IDLE detect Note: override IDLE control.
		4	IDLE_SEL			Yes	1: Output is MUTED (electrical idle) 0: Output is ON Note: override IDLE control.
		3:2	RXDET			Yes	00: Input is high-z impedance 01: Auto RX-Detect, outputs test every 12 ms for 600 ms (50 times) then stops; termination is high-z until detection; once detected input termination is 50 Ω 10: Auto RX-Detect, outputs test every 12 ms until detection occurs; termination is high-z until detection; once detected input termination is 50 Ω 11: Input is 50 Ω Note: override RXDET pin.
		1:0	Reserved				Set bits to 0.
0x3A	CH6 - CHA2 EQ	7:0	EQ Control	R/W	0x2F	Yes	IA2 EQ Control - total of 256 levels. See Table 2 .
0x3B	CH6 - CHA2 VOD	7	Short Circuit Protection	R/W	0xAD	Yes	1: Enable the short circuit protection 0: Disable the short circuit protection
		6	MODE_SEL			Yes	1: PCIe Gen-1 or PCIe Gen-2 0: PCIe Gen-3 Note: override the MODE pin.
		5:3	Reserved			Yes	Set bits to default value - 101.
		2:0	VOD Control			Yes	OA2 VOD Control 000: 0.7 V 001: 0.8 V 010: 0.9 V 011: 1.0 V 100: 1.1 V 101: 1.2 V (default) 110: 1.3 V 111: 1.4 V

Register Maps (continued)
Table 10. SMBUS Slave Mode Register Map (continued)

Address	Register Name	Bit	Field	Type	Default	EEPROM Bit	Description
0x3C	CH6 - CHA2 DEM	7	RXDET STATUS	R	0x02		Observation bit for RXDET CH6 - CHA2. 1: RX = detected 0: RX = not detected
		6:5	MODE_DET STATUS	R			Observation bit for MODE_DET CH6 - CHA2. 00: PCIe Gen-1 (2.5G) 01: PCIe Gen-2 (5G) 11: PCIe Gen-3 (8G+) Note: Only functions when MODE Pin = Automatic
		4:3	Reserved	R/W			Set bits to 0.
		2:0	DEM Control	R/W		Yes	OA2 DEM Control 000: 0 dB 001: -1.5 dB 010: -3.5 dB (default) 011: -5 dB 100: -6 dB 101: -8 dB 110: -9 dB 111: -12 dB
0x3D	CH6 - CHA2 IDLE Threshold	7:4	Reserved	R/W	0x00		Set bits to 0.
		3:2	IDLE tha			Yes	Assert threshold 00 = 180 mVp-p (default) 01 = 160 mVp-p 10 = 210 mVp-p 11 = 190 mVp-p Note: override the SD_TH pin.
		1:0	IDLE thd			Yes	De-Assert threshold 00 = 110 mVp-p (default) 01 = 100 mVp-p 10 = 150 mVp-p 11 = 130 mVp-p Note: override the SD_TH pin.
0x3E	Reserved	7:0	Reserved	R/W	0x00		Set bits to 0
0x3F	CH0 - CHB0 Signal Detect	7:3	Reserved	R/W	0x00		Set bits to 0.
		2	SD Reset				1: Force signal detect "off" 0: Normal operation
		1	SD Preset				1: Force signal detect "on" 0: Normal operation
		0	Reserved				Set bit to 0.

Register Maps (continued)
Table 10. SMBUS Slave Mode Register Map (continued)

Address	Register Name	Bit	Field	Type	Default	EEPROM Bit	Description
0x40	CH7 - CHA3 IDLE, RXDET	7:6	Reserved	R/W	0x00		Set bits to 0.
		5	IDLE_AUTO			Yes	1 = Allow IDLE_SEL control in bit 4 0 = Automatic IDLE detect Note: override IDLE control.
		4	IDLE_SEL			Yes	1: Output is MUTED (electrical idle) 0: Output is ON Note: override IDLE control.
		3:2	RXDET			Yes	00: Input is high-z impedance 01: Auto RX-Detect, outputs test every 12 ms for 600 ms (50 times) then stops; termination is high-z until detection; once detected input termination is 50 Ω 10: Auto RX-Detect, outputs test every 12 ms until detection occurs; termination is high-z until detection; once detected input termination is 50 Ω 11: Input is 50 Ω Note: override RXDET pin.
		1:0	Reserved				Set bits to 0.
0x41	CH7 - CHA3 EQ	7:0	EQ Control	R/W	0x2F	Yes	IA3 EQ Control - total of 256 levels. See Table 2 .
0x42	CH7 - CHA3 VOD	7	Short Circuit Protection	R/W	0xAD	Yes	1: Enable the short circuit protection 0: Disable the short circuit protection
		6	MODE_SEL			Yes	1: PCIe Gen-1 or PCIe Gen-2 0: PCIe Gen-3 Note: override the MODE pin.
		5:3	Reserved			Yes	Set bits to default value - 101.
		2:0	VOD Control			Yes	OA3 VOD Control 000: 0.7 V 001: 0.8 V 010: 0.9 V 011: 1.0 V 100: 1.1 V 101: 1.2 V (default) 110: 1.3 V 111: 1.4 V

Register Maps (continued)
Table 10. SMBUS Slave Mode Register Map (continued)

Address	Register Name	Bit	Field	Type	Default	EEPROM Bit	Description
0x43	CH7 - CHA3 DEM	7	RXDET STATUS	R	0x02		Observation bit for RXDET CH7 - CHA3. 1: RX = detected 0: RX = not detected
		6:5	MODE_DET STATUS	R			Observation bit for MODE_DET CH7 - CHA3. 00: PCIe Gen-1 (2.5G) 01: PCIe Gen-2 (5G) 11: PCIe Gen-3 (8G+) Note: Only functions when MODE Pin = Automatic
		4:3	Reserved	R/W			Set bits to 0.
		2:0	DEM Control	R/W		Yes	OA3 DEM Control 000: 0 dB 001: -1.5 dB 010: -3.5 dB (default) 011: -5 dB 100: -6 dB 101: -8 dB 110: -9 dB 111: -12 dB
0x44	CH7 - CHA3 IDLE Threshold	7:4	Reserved	R/W	0x00		Set bits to 0.
		3:2	IDLE tha			Yes	Assert threshold 00 = 180 mVp-p (default) 01 = 160 mVp-p 10 = 210 mVp-p 11 = 190 mVp-p Note: override the SD_TH pin.
		1:0	IDLE thd			Yes	De-Assert threshold 00 = 110 mVp-p (default) 01 = 100 mVp-p 10 = 150 mVp-p 11 = 130 mVp-p Note: override the SD_TH pin.
0x45	Reserved	7:0	Reserved	R/W	0x00		Set bits to 0
0x46	Reserved	7:0	Reserved	R/W	0x38		Set bits to 0x38
0x47	Reserved	7:4	Reserved	R/W	0x00		Set bits to 0
		3:0	Reserved	R/W		Yes	Set bits to 0
0x48	Reserved	7:6	Reserved	R/W	0x05	Yes	Set bits to 0
		5:0	Reserved	R/W			Set bits to 00 0101'b
0x49	Reserved	7:0	Reserved	R/W	0x00		Set bits to 0
0x4A	Reserved	7:0	Reserved	R/W	0x00		Set bits to 0
0x4B	Reserved	7:0	Reserved	R/W	0x00		Set bits to 0

Register Maps (continued)

Table 10. SMBUS Slave Mode Register Map (continued)

Address	Register Name	Bit	Field	Type	Default	EEPROM Bit	Description
0x4C	Reserved	7:3	Reserved	R/W	0x00	Yes	Set bits to 0
		2:1	Reserved	R/W			Set bits to 0
		0	Reserved	R/W		Yes	Set bits to 0
0x4D	Reserved	7:0	Reserved	R/W	0x00		Set bits to 0
0x4E	Reserved	7:0	Reserved	R/W	0x00		Set bits to 0
0x4F	Reserved	7:0	Reserved	R/W	0x00		Set bits to 0
0x50	Reserved	7:0	Reserved	R/W	0x00		Set bits to 0
0x51	Device ID	7:5	VERSION	R	0x45		010'b
		4:0	ID				00101'b
0x52	Reserved	7:0	Reserved	R/W	0x00		Set bits to 0
0x53	Reserved	7:0	Reserved	R/W	0x00		Set bits to 0
0x54	Reserved	7:0	Reserved	R/W	0x00		Set bits to 0
0x55	Reserved	7:0	Reserved	R/W	0x00		Set bits to 0
0x56	Reserved	7:0	Reserved	R/W	0x10		Set bits to 0x10
0x57	Reserved	7:0	Reserved	R/W	0x64		Set bits to 0x64
0x58	Reserved	7:0	Reserved	R/W	0x21		Set bits to 0x21
0x59	Reserved	7:1	Reserved	R/W	0x00		Set bits to 0
		0	Reserved			Yes	Set bit to 0
0x5A	Reserved	7:0	Reserved	R/W	0x54	Yes	Set bits to 0x54
0x5B	Reserved	7:0	Reserved	R/W	0x54	Yes	Set bits to 0x54
0x5C	Reserved	7:0	Reserved	R/W	0x00		Set bits to 0
0x5D	Reserved	7:0	Reserved	R/W	0x00		Set bits to 0
0x5E	Reserved	7:0	Reserved	R/W	0x00		Set bits to 0
0x5F	Reserved	7:0	Reserved	R/W	0x00		Set bits to 0
0x60	Reserved	7:0	Reserved	R/W	0x00		Set bits to 0
0x61	Reserved	7:0	Reserved	R/W	0x00		Set bits to 0

9 Application and Implementation

NOTE

Information in the following applications sections is not part of the TI component specification, and TI does not warrant its accuracy or completeness. TI's customers are responsible for determining suitability of components for their purposes. Customers should validate and test their design implementation to confirm system functionality.

9.1 Application Information

The DS125BR800 is a high performance circuit capable of delivering excellent performance. Careful attention must be paid to the details associated with high-speed design as well as providing a clean power supply. Refer to [Layout Guidelines](#) and the *LVDS Owner's Manual, SNLA187*, for more detailed information on high speed design tips to address signal integrity design issues.

9.2 Typical Application

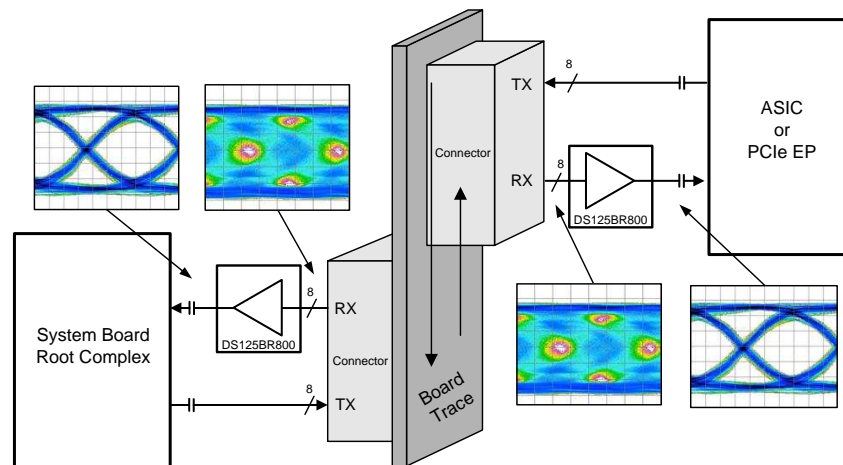

Figure 9. Typical Application

9.2.1 Design Requirements

As with any high speed design, there are many factors which influence the overall performance. Below are a list of critical areas for consideration and study during design.

- Use 100 Ω impedance traces. Generally these are very loosely coupled to ease routing length differences.
- Place AC-coupling capacitors near to the receiver end of each channel segment to minimize reflections.
- The maximum body size for AC-coupling capacitors is 0402.
- Back-drill connector vias and signal vias to minimize stub length.
- Use Reference plane vias to ensure a low inductance path for the return current.

9.2.2 Detailed Design Procedure

The DS125BR800 is designed to be placed at a location where the input CTLE can help to compensate for a portion of the overall channel attenuation. In order to optimize performance, the repeater requires tuning to extend the reach of the cable or trace length while also recovering a solid eye opening. To tune the repeater, the settings mentioned in [Table 2](#) and [Table 3](#) (for Pin Mode) are recommended as a default starting point for most applications. Once these settings are configured, additional tuning of the EQ and, to a lesser extent, VOD may be required to optimize the repeater performance for each specific application environment. Examples of the repeater performance as a generic high speed datapath repeater are illustrated in the performance curves in the next section.

Typical Application (continued)

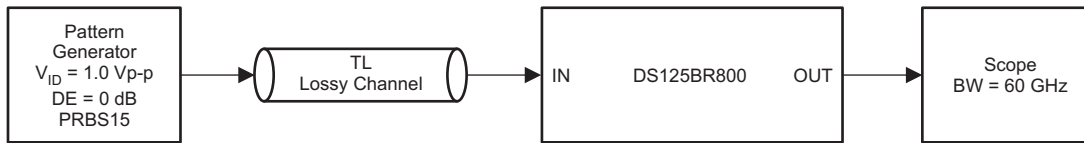
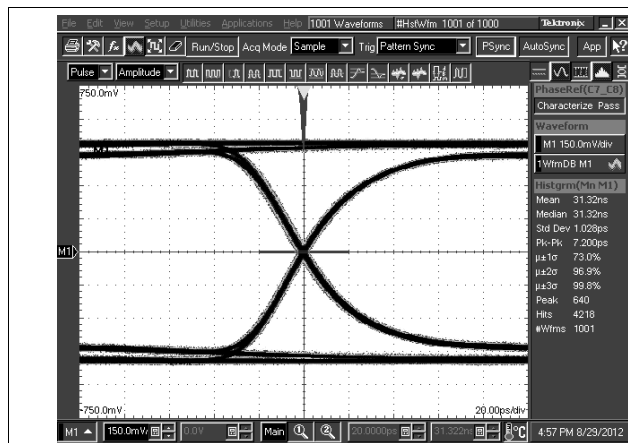

Figure 10. Test Setup Connections Diagram

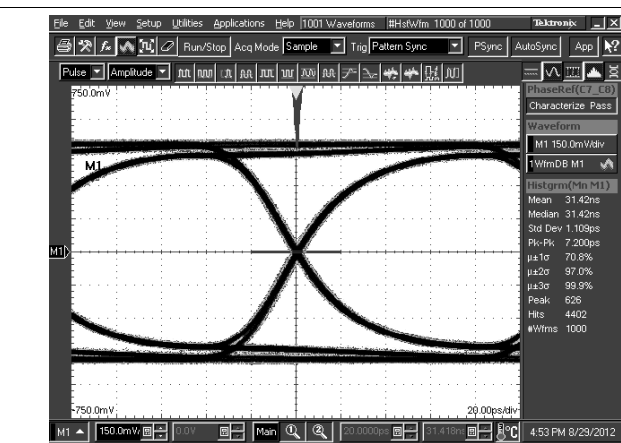

Figure 11. Test Setup Connections Diagram

9.2.3 Application Curves



DS125BR800 settings: EQ[1:0] = 0, F = 0x02, DEM[1:0] = 0, 1
Figure 12. TL = 10 inch 5-mil FR4 trace, 5 Gbps



DS125BR800 settings: EQ[1:0] = 0, F = 0x02, DEM[1:0] = 0, 1
Figure 13. TL = 10 inch 5-mil FR4 trace, 8 Gbps

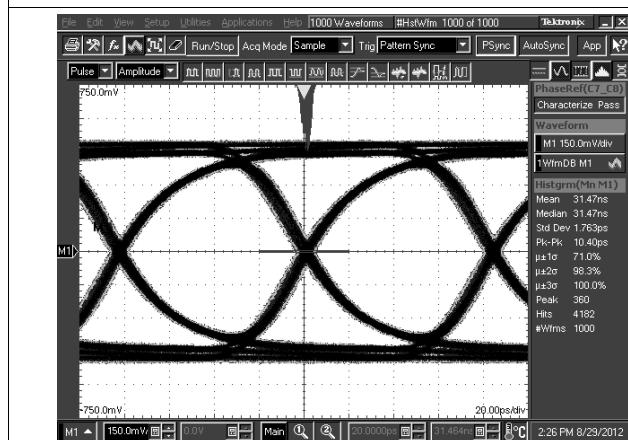

DS125BR800 settings: EQ[1:0] = 0, R = 0x01, DEM[1:0] = 0, 1
Figure 14. TL = 10 inch 5-mil FR4 trace, 12 Gbps

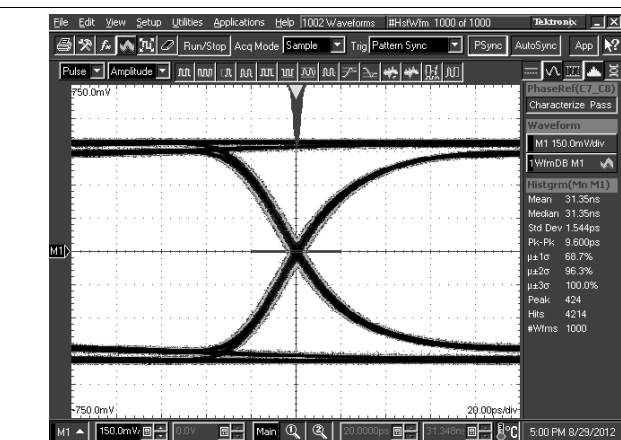

DS125BR800 settings: EQ[1:0] = 0, 1 = 0x03, DEM[1:0] = 0, 1
Figure 15. TL = 20 inch 5-mil FR4 trace, 5 Gbps

Typical Application (continued)

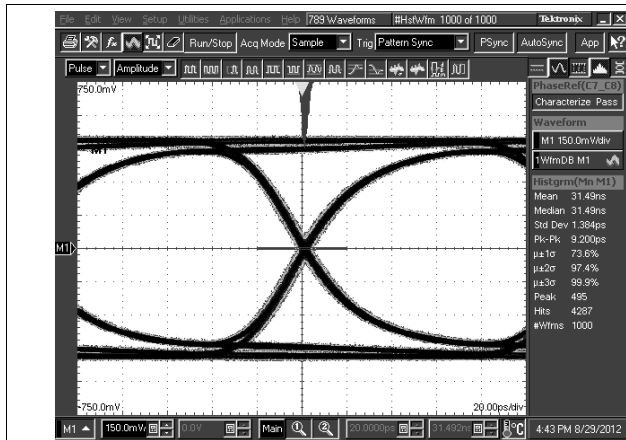

DS125BR800 settings: EQ[1:0] = 0, 1 = 0x03, DEM[1:0] = 0, 1
 Figure 16. TL = 20 inch 5-mil FR4 trace, 8 Gbps

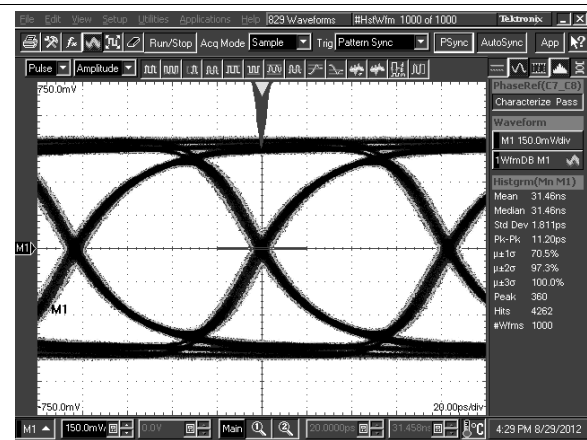

DS125BR800 settings: EQ[1:0] = 0, 1 = 0x03, DEM[1:0] = 0, 1
 Figure 17. TL = 20 inch 5-mil FR4 trace, 12 Gbps

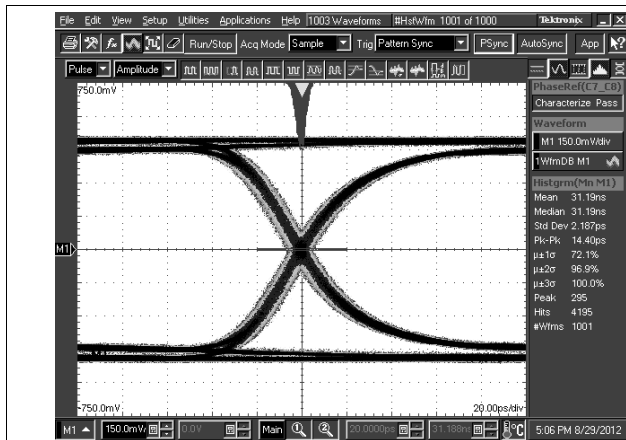

DS125BR800 settings: EQ[1:0] = R, 0 = 0x07, DEM[1:0] = 0, 1
 Figure 18. TL = 30 inch 5-mil FR4 trace, 5 Gbps

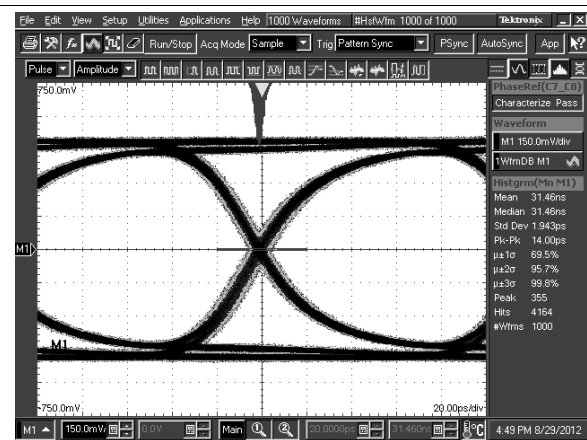

DS125BR800 settings: EQ[1:0] = R, 0 = 0x07, DEM[1:0] = 0, 1
 Figure 19. TL = 30 inch 5-mil FR4 trace, 8 Gbps

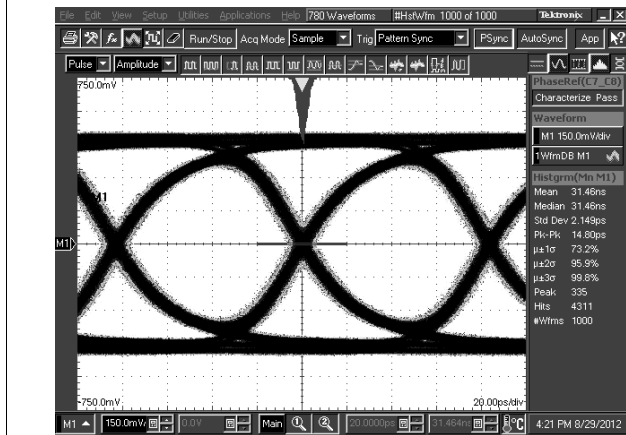

DS125BR800 settings: EQ[1:0] = R, 0 = 0x07, DEM[1:0] = 0, 1
 Figure 20. TL = 30 inch 5-mil FR4 trace, 12 Gbps

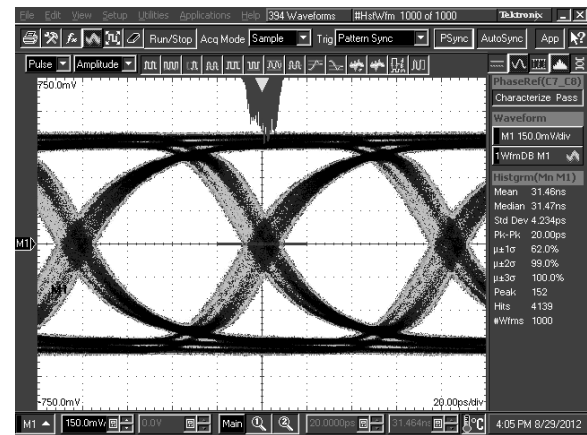

DS125BR800 settings: EQ[1:0] = R, 0 = 0x07, DEM[1:0] = 0, 1
 Figure 21. TL1 = 5-meter 30-AWG 100 Ω Twin-axial Cable, 12 Gbps

Typical Application (continued)

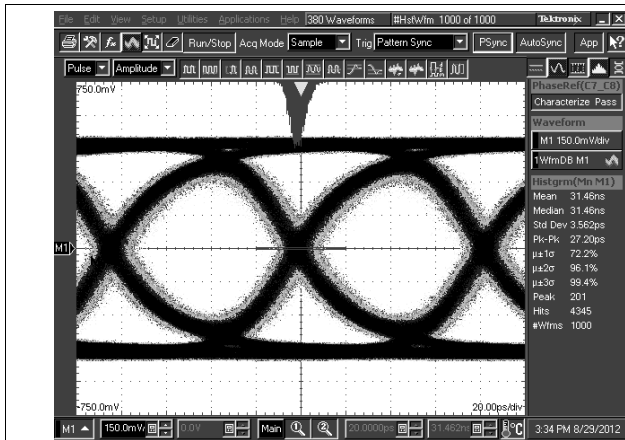

DS125BR800 settings: EQ[1:0] = R, 1 = 0x0F, DEM[1:0] = 0, 1
Figure 22. TL1 = 8-meter 30-AWG 100 Ω Twin-axial Cable, 12 Gbps

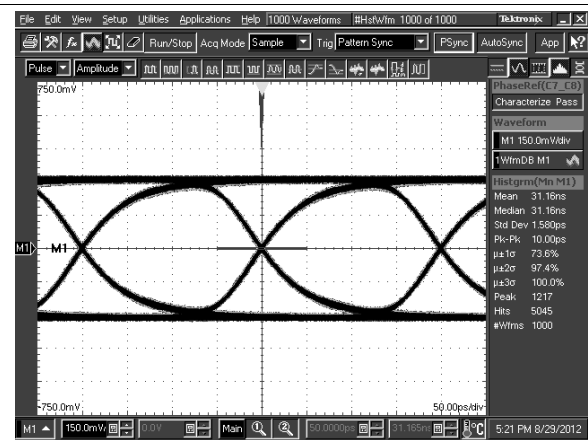

DS125BR800 settings: EQ[1:0] = 0, 1 = 0x03, DEM[1:0] = R, 0
Figure 23. TL1 = 20 inch 5-mil FR4 trace, TL2 = 10 inch 5-mil FR4 trace, 5 Gbps

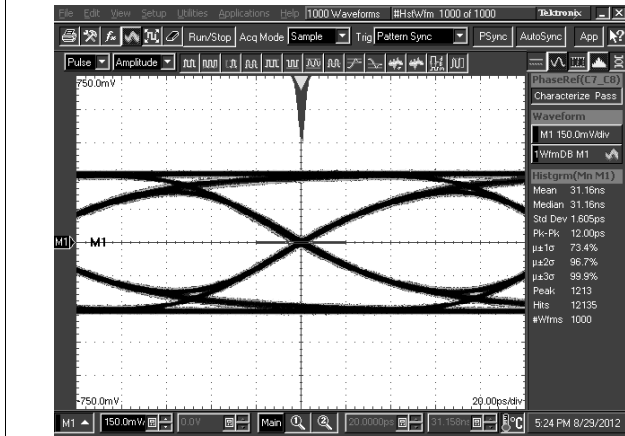

DS125BR800 settings: EQ[1:0] = R, 1 = 0x0F, DEM[1:0] = R, 0
Figure 24. TL1 = 20 inch 5-mil FR4 trace, TL2 = 10 inch 5-mil FR4 trace, 8 Gbps

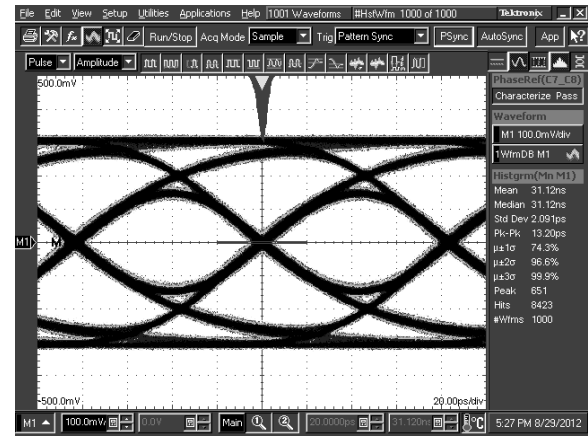

DS125BR800 settings: EQ[1:0] = R, 1 = 0x0F, DEM[1:0] = R, 0
Figure 25. TL1 = 20 inch 5-mil FR4 trace, TL2 = 10 inch 5-mil FR4 trace, 12 Gbps

10 Power Supply Recommendations

10.1 3.3-V or 2.5-V Supply Mode Operation

The DS125BR800 has an optional internal voltage regulator to provide the 2.5-V supply to the device. In 3.3-V mode operation, the VIN pin = 3.3 V is used to supply power to the device. The internal regulator will provide the 2.5 V to the VDD pins of the device and a 0.1- μ F cap is needed at each of the 5 VDD pins for power supply decoupling (total capacitance should be $\leq 0.5 \mu$ F), and the VDD_SEL pin must be tied to GND to enable the internal regulator. In 2.5-V mode operation, the VIN pin should be left open and 2.5-V supply must be applied to the 5 VDD pins to power the device. The VDD_SEL pin must be left open (no connect) to disable the internal regulator.

The DS125BR800 has an optional internal voltage regulator to provide the 2.5 V supply to the device. In 3.3-V Mode operation, the VIN pin = 3.3 V is used to supply power to the device. The internal regulator will provide the 2.5 V to the VDD pins of the device and a 0.1- μ F cap is needed at each of the 5 VDD pins for power supply decoupling (total capacitance should be $\leq 0.5 \mu$ F), and the VDD_SEL pin must be tied to GND to enable the internal regulator. In 2.5-V Mode operation, the VIN pin should be left open and 2.5-V supply must be applied to the 5 VDD pins to power the device. The VDD_SEL pin must be left open (no connect) to disable the internal regulator.

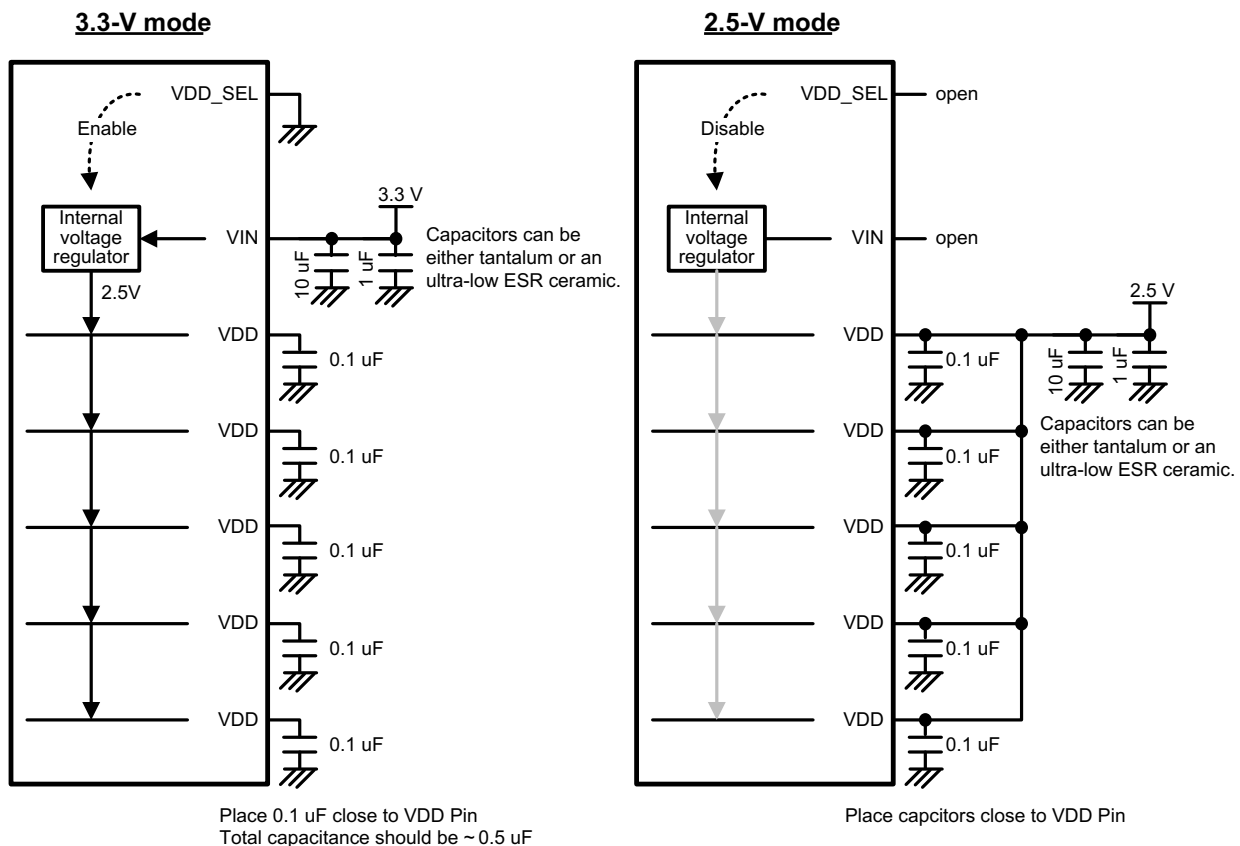

Figure 26. 3.3-V or 2.5-V Supply Connection Diagram

10.2 Power Supply Bypassing

Two approaches are recommended to ensure that the DS125BR800 is provided with an adequate power supply. First, the supply (VDD) and ground (GND) pins should be connected to power planes routed on adjacent layers of the printed circuit board. The layer thickness of the dielectric should be minimized so that the VDD and GND planes create a low inductance supply with distributed capacitance. Second, careful attention to supply bypassing through the proper use of bypass capacitors is required. A 0.1- μ F bypass capacitor should be connected to each VDD pin such that the capacitor is placed as close as possible to the DS125BR800. Smaller body size capacitors can help facilitate proper component placement. Additionally, capacitor with capacitance in the range of 1 μ F to 10 μ F should be incorporated in the power supply bypassing design as well. These capacitors can be either tantalum or an ultra-low ESR ceramic.

11 Layout

11.1 Layout Guidelines

The CML inputs and LPDS outputs have been optimized to work with interconnects using a controlled differential impedance of 85 - 100 Ω . It is preferable to route differential lines exclusively on one layer of the board, particularly for the input traces. The use of vias should be avoided if possible. If vias must be used, they should be used sparingly and must be placed symmetrically for each side of a given differential pair. Whenever differential vias are used the layout must also provide for a low inductance path for the return currents as well. Route the differential signals away from other signals and noise sources on the printed circuit board. See AN-1187 for additional information on LLP packages.

[Figure 27](#) depicts different transmission line topologies which can be used in various combinations to achieve the optimal system performance. Impedance discontinuities at the differential via can be minimized or eliminated by increasing the swell around each hole and providing for a low inductance return current path. When the via structure is associated with thick backplane PCB, further optimization such as back drilling is often used to reduce the detrimental high frequency effects of stubs on the signal path.

11.2 Layout Example

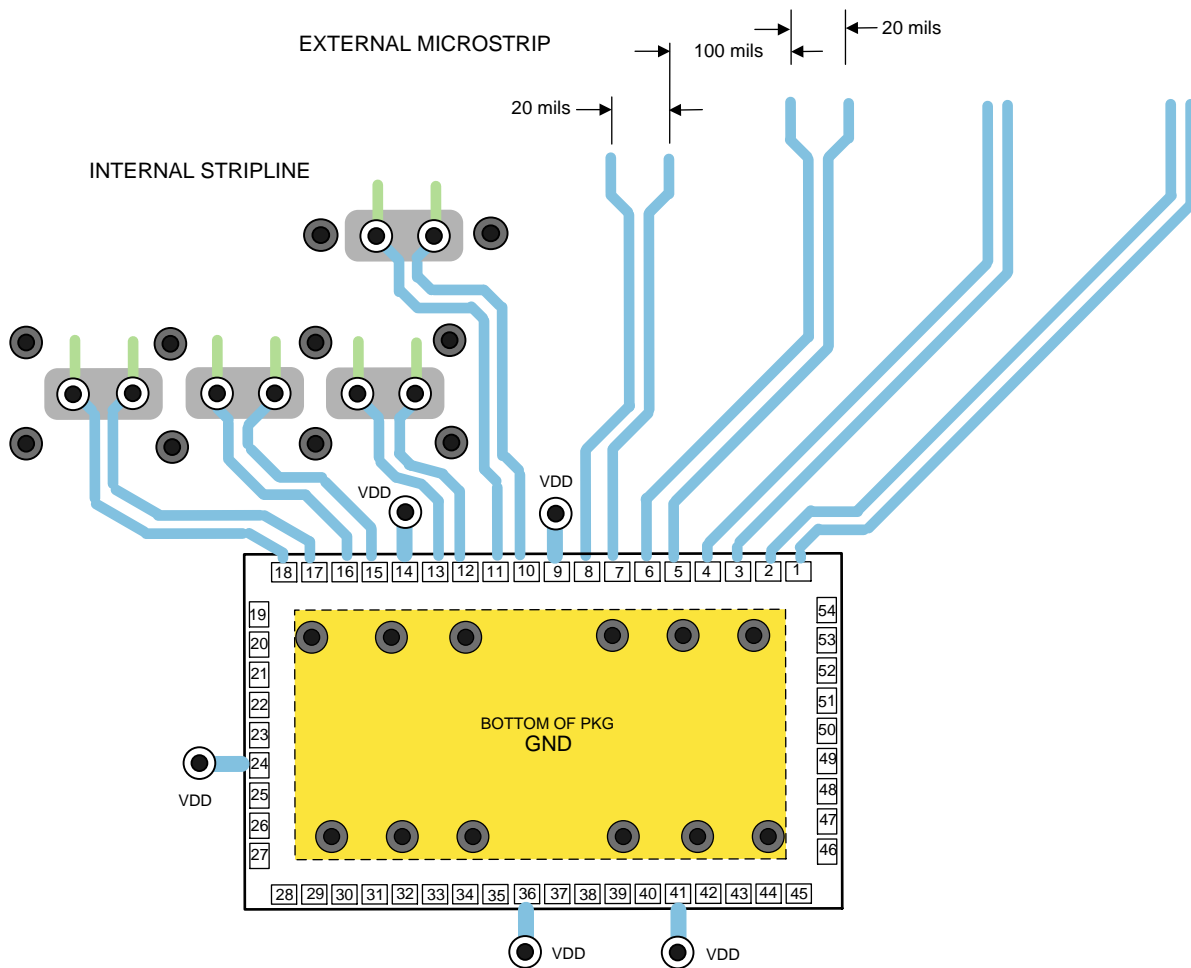

Figure 27. Typical Routing Options

12 Device and Documentation Support

12.1 Documentation Support

12.1.1 Related Documentation

- [Absolute Maximum Ratings for Soldering](#) (SNOA549)
- [LVDS Owner's Manual](#) (SNLA187)
- [Understanding EEPROM Programming for High Speed Repeaters and Mux Buffers](#) (SNLA228)

12.2 Receiving Notification of Documentation Updates

To receive notification of documentation updates, navigate to the device product folder on ti.com. In the upper right corner, click on *Alert me* to register and receive a weekly digest of any product information that has changed. For change details, review the revision history included in any revised document.

12.3 Trademarks

All trademarks are the property of their respective owners.

12.4 Electrostatic Discharge Caution



These devices have limited built-in ESD protection. The leads should be shorted together or the device placed in conductive foam during storage or handling to prevent electrostatic damage to the MOS gates.

12.5 Glossary

[SLYZ022](#) — *TI Glossary*.

This glossary lists and explains terms, acronyms, and definitions.

13 Mechanical, Packaging, and Orderable Information

The following pages include mechanical, packaging, and orderable information. This information is the most current data available for the designated devices. This data is subject to change without notice and revision of this document. For browser-based versions of this data sheet, refer to the left-hand navigation.

PACKAGING INFORMATION

Orderable Device	Status (1)	Package Type	Package Drawing	Pins	Package Qty	Eco Plan (2)	Lead finish/ Ball material (6)	MSL Peak Temp (3)	Op Temp (°C)	Device Marking (4/5)	Samples
DS125BR800SQ/NOPB	ACTIVE	WQFN	NJY	54	2000	RoHS & Green	SN	Level-2-260C-1 YEAR	-40 to 85	DS125BR800SQ	Samples
DS125BR800SQE/NOPB	ACTIVE	WQFN	NJY	54	250	RoHS & Green	SN	Level-2-260C-1 YEAR	-40 to 85	DS125BR800SQ	Samples

(1) The marketing status values are defined as follows:

ACTIVE: Product device recommended for new designs.

LIFEBUY: TI has announced that the device will be discontinued, and a lifetime-buy period is in effect.

NRND: Not recommended for new designs. Device is in production to support existing customers, but TI does not recommend using this part in a new design.

PREVIEW: Device has been announced but is not in production. Samples may or may not be available.

OBSOLETE: TI has discontinued the production of the device.

(2) **RoHS:** TI defines "RoHS" to mean semiconductor products that are compliant with the current EU RoHS requirements for all 10 RoHS substances, including the requirement that RoHS substance do not exceed 0.1% by weight in homogeneous materials. Where designed to be soldered at high temperatures, "RoHS" products are suitable for use in specified lead-free processes. TI may reference these types of products as "Pb-Free".

RoHS Exempt: TI defines "RoHS Exempt" to mean products that contain lead but are compliant with EU RoHS pursuant to a specific EU RoHS exemption.

Green: TI defines "Green" to mean the content of Chlorine (Cl) and Bromine (Br) based flame retardants meet JS709B low halogen requirements of <=1000ppm threshold. Antimony trioxide based flame retardants must also meet the <=1000ppm threshold requirement.

(3) MSL, Peak Temp. - The Moisture Sensitivity Level rating according to the JEDEC industry standard classifications, and peak solder temperature.

(4) There may be additional marking, which relates to the logo, the lot trace code information, or the environmental category on the device.

(5) Multiple Device Markings will be inside parentheses. Only one Device Marking contained in parentheses and separated by a "~" will appear on a device. If a line is indented then it is a continuation of the previous line and the two combined represent the entire Device Marking for that device.

(6) Lead finish/Ball material - Orderable Devices may have multiple material finish options. Finish options are separated by a vertical ruled line. Lead finish/Ball material values may wrap to two lines if the finish value exceeds the maximum column width.

Important Information and Disclaimer:The information provided on this page represents TI's knowledge and belief as of the date that it is provided. TI bases its knowledge and belief on information provided by third parties, and makes no representation or warranty as to the accuracy of such information. Efforts are underway to better integrate information from third parties. TI has taken and continues to take reasonable steps to provide representative and accurate information but may not have conducted destructive testing or chemical analysis on incoming materials and chemicals. TI and TI suppliers consider certain information to be proprietary, and thus CAS numbers and other limited information may not be available for release.

In no event shall TI's liability arising out of such information exceed the total purchase price of the TI part(s) at issue in this document sold by TI to Customer on an annual basis.

TAPE AND REEL INFORMATION

QUADRANT ASSIGNMENTS FOR PIN 1 ORIENTATION IN TAPE



*All dimensions are nominal

Device	Package Type	Package Drawing	Pins	SPQ	Reel Diameter (mm)	Reel Width W1 (mm)	A0 (mm)	B0 (mm)	K0 (mm)	P1 (mm)	W (mm)	Pin1 Quadrant
DS125BR800SQ/NOPB	WQFN	NJY	54	2000	330.0	16.4	5.8	10.3	1.0	12.0	16.0	Q1
DS125BR800SQE/NOPB	WQFN	NJY	54	250	178.0	16.4	5.8	10.3	1.0	12.0	16.0	Q1

TAPE AND REEL BOX DIMENSIONS

*All dimensions are nominal

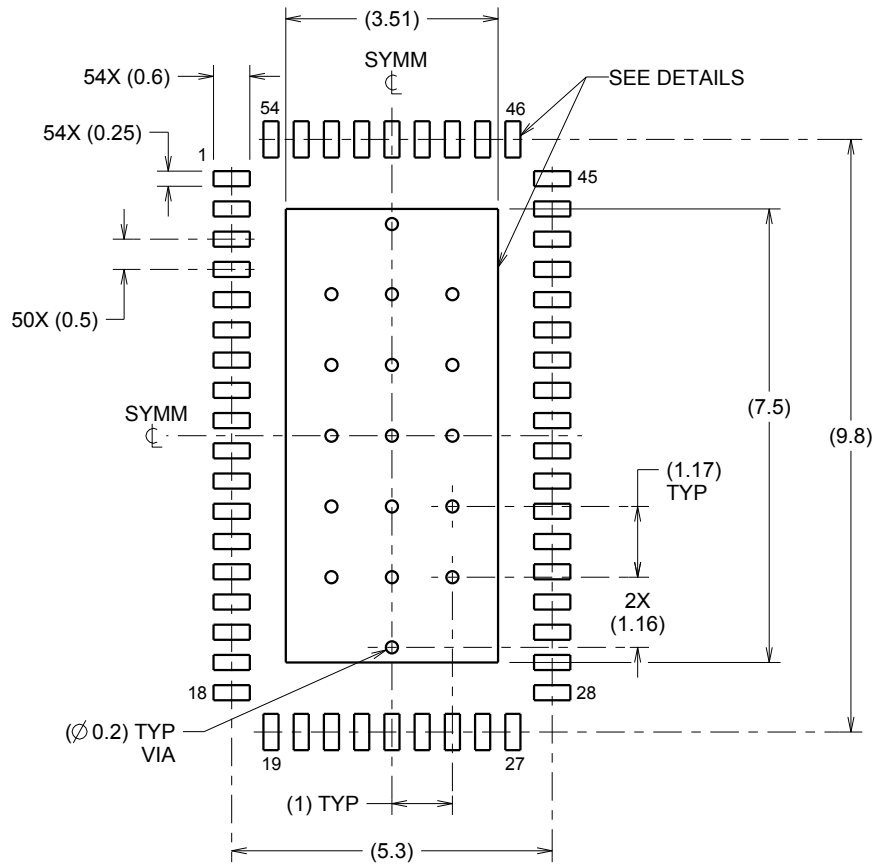
Device	Package Type	Package Drawing	Pins	SPQ	Length (mm)	Width (mm)	Height (mm)
DS125BR800SQ/NOPB	WQFN	NJY	54	2000	356.0	356.0	36.0
DS125BR800SQE/NOPB	WQFN	NJY	54	250	208.0	191.0	35.0



LAND PATTERN EXAMPLE
SCALE:8X

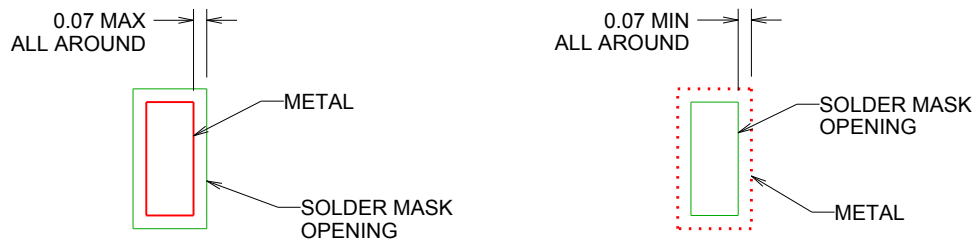

NON SOLDER MASK
DEFINED
(PREFERRED)

SOLDER MASK
DEFINED

SOLDER MASK DETAILS

4214993/A 07/2013

NOTES: (continued)

- This package is designed to be soldered to a thermal pad on the board. For more information, refer to QFN/SON PCB application note in literature No. SLUA271 (www.ti.com/lit/slua271).

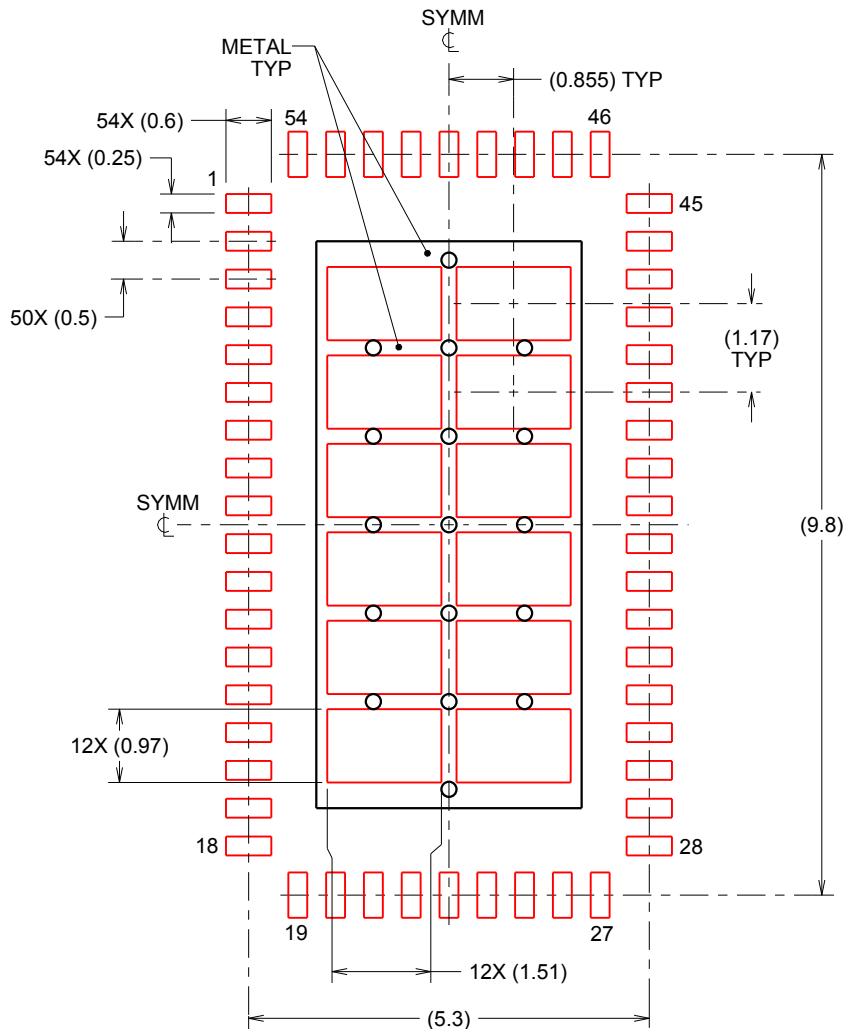

SOLDERPASTE EXAMPLE
 BASED ON 0.125mm THICK STENCIL

EXPOSED PAD
 67% PRINTED SOLDER COVERAGE BY AREA
 SCALE:10X

4214993/A 07/2013

NOTES: (continued)

5. Laser cutting apertures with trapezoidal walls and rounded corners may offer better paste release. IPC-7525 may have alternate design recommendations.

IMPORTANT NOTICE AND DISCLAIMER

TI PROVIDES TECHNICAL AND RELIABILITY DATA (INCLUDING DATA SHEETS), DESIGN RESOURCES (INCLUDING REFERENCE DESIGNS), APPLICATION OR OTHER DESIGN ADVICE, WEB TOOLS, SAFETY INFORMATION, AND OTHER RESOURCES "AS IS" AND WITH ALL FAULTS, AND DISCLAIMS ALL WARRANTIES, EXPRESS AND IMPLIED, INCLUDING WITHOUT LIMITATION ANY IMPLIED WARRANTIES OF MERCHANTABILITY, FITNESS FOR A PARTICULAR PURPOSE OR NON-INFRINGEMENT OF THIRD PARTY INTELLECTUAL PROPERTY RIGHTS.

These resources are intended for skilled developers designing with TI products. You are solely responsible for (1) selecting the appropriate TI products for your application, (2) designing, validating and testing your application, and (3) ensuring your application meets applicable standards, and any other safety, security, regulatory or other requirements.

These resources are subject to change without notice. TI grants you permission to use these resources only for development of an application that uses the TI products described in the resource. Other reproduction and display of these resources is prohibited. No license is granted to any other TI intellectual property right or to any third party intellectual property right. TI disclaims responsibility for, and you will fully indemnify TI and its representatives against, any claims, damages, costs, losses, and liabilities arising out of your use of these resources.

TI's products are provided subject to [TI's Terms of Sale](#) or other applicable terms available either on [ti.com](https://www.ti.com) or provided in conjunction with such TI products. TI's provision of these resources does not expand or otherwise alter TI's applicable warranties or warranty disclaimers for TI products.

TI objects to and rejects any additional or different terms you may have proposed.

Mailing Address: Texas Instruments, Post Office Box 655303, Dallas, Texas 75265
Copyright © 2024, Texas Instruments Incorporated