

This document can handle board shapes up to 7.9in x 10in, although our panel vendors top out at 7in x 10in.

To re-size the board shape, do the following:

Select lines on M1 Board Outline and delete (easy in single layer mode...shift+s)

Draw a rectangle using lines (example will be for a 4 x 6 board)

Enter Place Line mode (keyboard pl)

keyboard jo to jump to origin, hit enter

keyboard j1 to jump to location, set x to 6000, hit enter twice

keyboard j1 to jump to location, set x to 6000 and y to 4000, hit enter twice

keyboard j1 to jump to location, set x to 0 and y to 4000, hit enter twice

keyboard jo to jump to origin, hit enter

Hit ESC twice to exit place line mode

Select lines on M1 Board Outline

Menu Design|Board Shape|Define from Selected Objects (keyboard dsd)

If you re-size the board, don't forget to move the drill table strings on the Drill Drawing Layer...they should be just to the right of your board shape

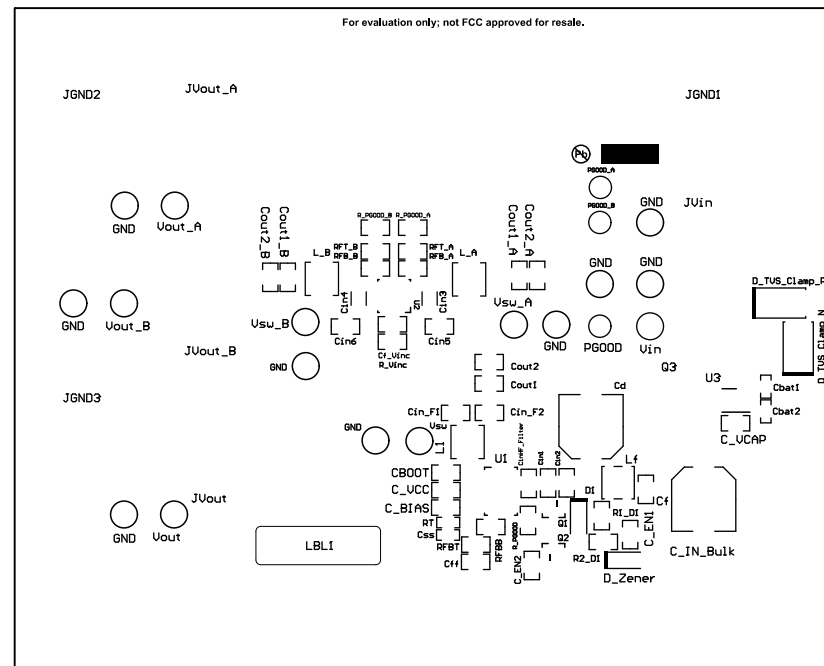

ALL ARTWORK VIEWED FROM TOP SIDE	BOARD #: PMP15023	REV: E1	SUN REV: Not In VersionControl
LAYER NAME = Top Overlay	TID #: PMP15023		
PLOT NAME = Top Overlay	GENERATED : 3/25/2020	2:14:00 PM	TEXAS INSTRUMENTS

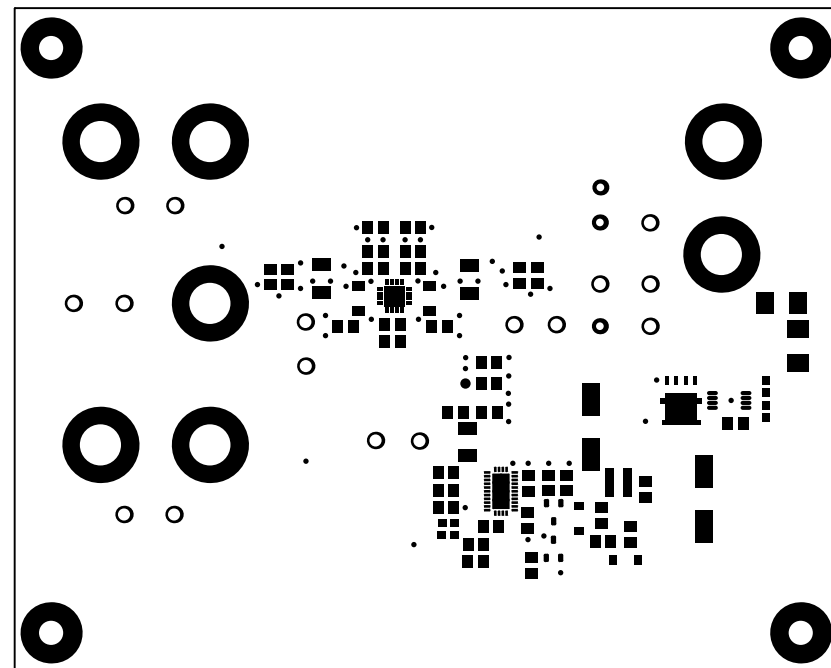

ALL ARTWORK VIEWED FROM TOP SIDE	BOARD #: PMP15023	REV: E1	SUN REV: Not In VersionControl
LAYER NAME = Top Solder	TID #: PMP15023		
PLOT NAME = Top Solder Mask	GENERATED : 3/25/2020 2:14:01 PM	TEXAS INSTRUMENTS	

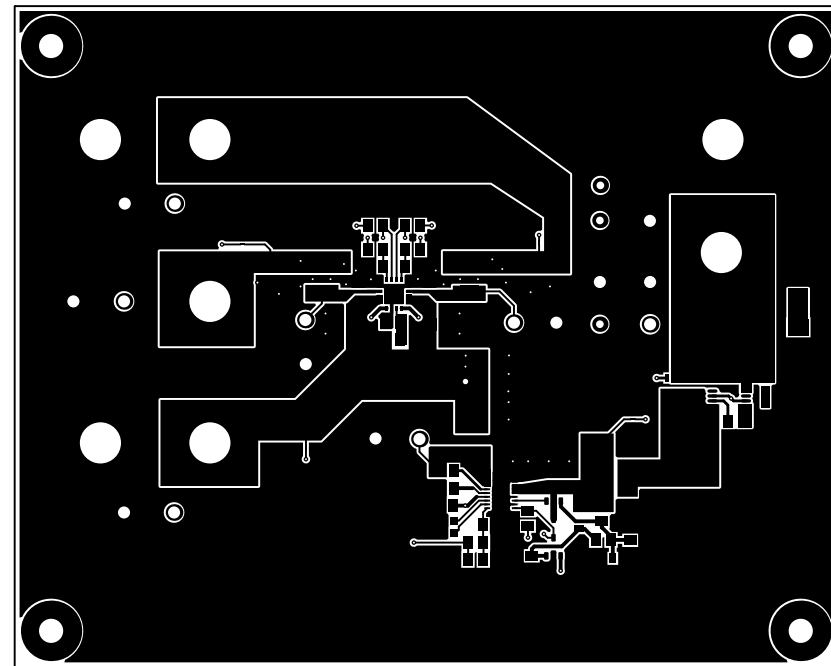

ALL ARTWORK VIEWED FROM TOP SIDE	BOARD #: PMP15023	REV: E1	SUN REV: Not In VersionControl
LAYER NAME = Top Layer	TID #: PMP15023		
PLOT NAME = Top Layer	GENERATED : 3/25/2020 2:14:02 PM	TEXAS INSTRUMENTS	

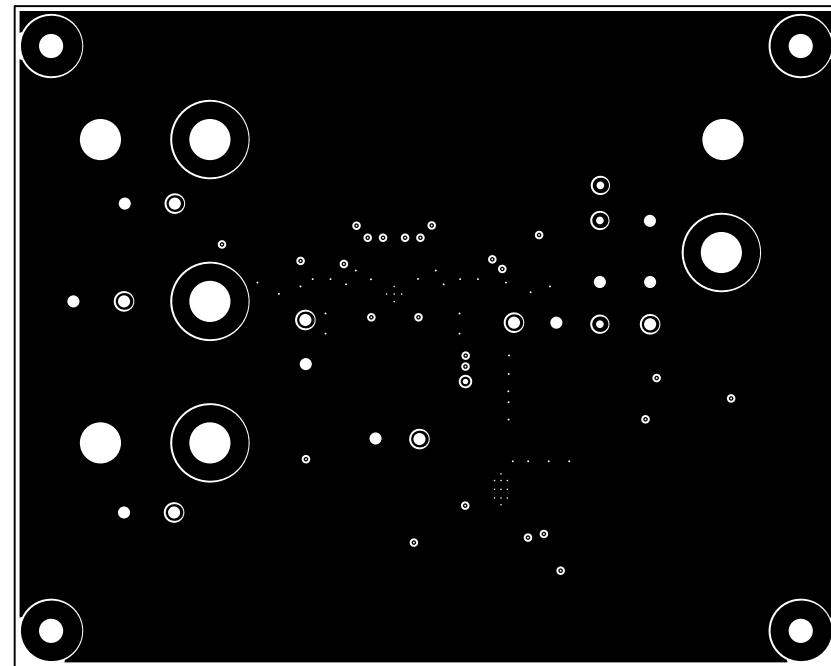

ALL ARTWORK VIEWED FROM TOP SIDE	BOARD #: PMP15023	REV: E1	SUN REV: Not In VersionControl
LAYER NAME =	TID #: PMP15023		
PLOT NAME = Signal Layer 1	GENERATED : 3/25/2020 2:14:04 PM	TEXAS INSTRUMENTS	

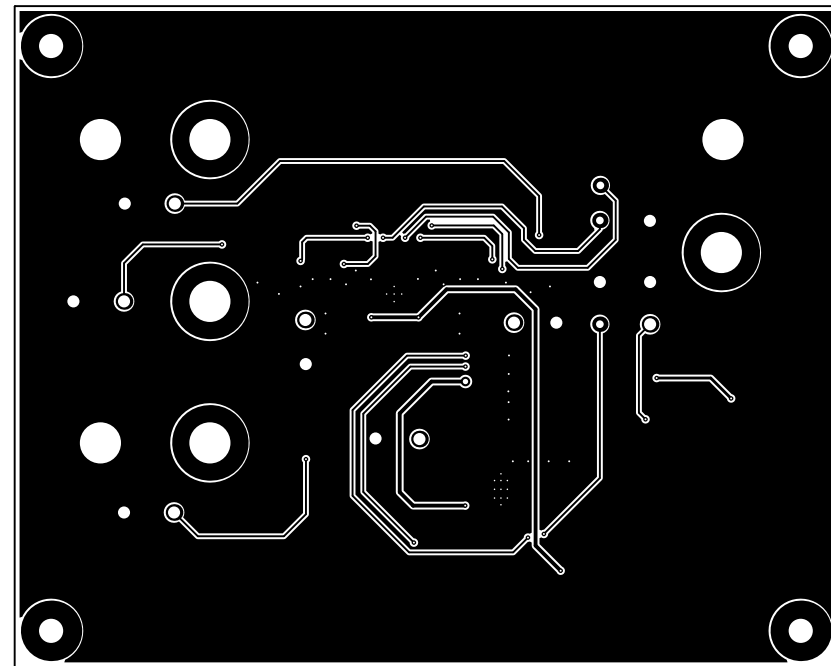

ALL ARTWORK VIEWED FROM TOP SIDE	BOARD #: PMP15023	REV: E1	SUN REV: Not In VersionControl
LAYER NAME =	TID #: PMP15023		
PLOT NAME = Signal Layer 2	GENERATED : 3/25/2020 2:14:05 PM	TEXAS INSTRUMENTS	

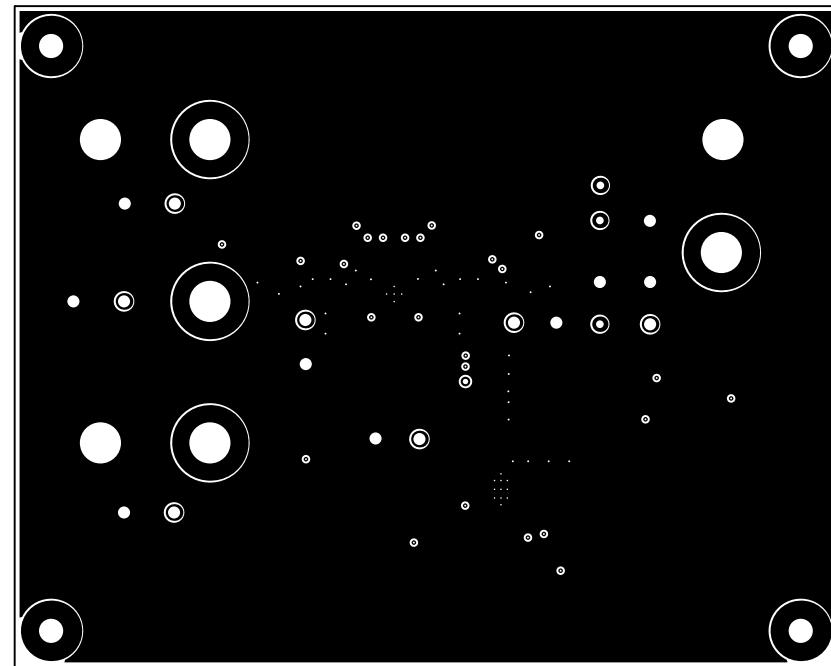

ALL ARTWORK VIEWED FROM TOP SIDE	BOARD #: PMP15023	REV: E1	SUN REV: Not In VersionControl
LAYER NAME = Bottom Layer	TID #: PMP15023		
PLOT NAME = Bottom Layer	GENERATED : 3/25/2020 2:14:06 PM	TEXAS INSTRUMENTS	

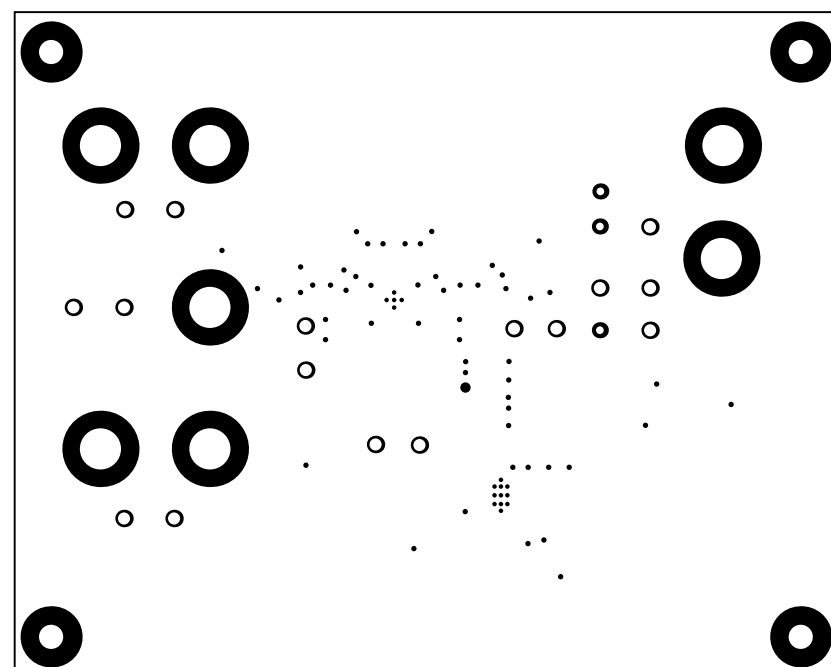

ALL ARTWORK VIEWED FROM TOP SIDE	BOARD #: PMP15023	REV: E1	SUN REV: Not In VersionControl
LAYER NAME = Bottom Solder	TID #: PMP15023		
PLOT NAME = Bottom Solder Mask	GENERATED : 3/25/2020 2:14:08 PM	TEXAS INSTRUMENTS	

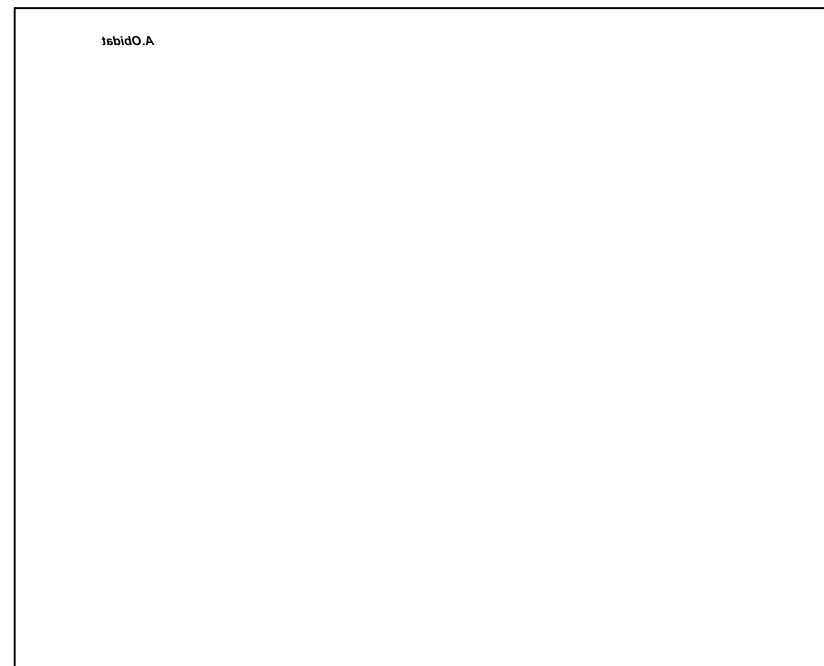

ALL ARTWORK VIEWED FROM TOP SIDE	BOARD #: PMP15023	REV: E1	SUN REV: Not In VersionControl
LAYER NAME = Bottom Overlay	TID #: PMP15023		
PLOT NAME = Bottom Overlay	GENERATED : 3/25/2020 2:14:09 PM	TEXAS INSTRUMENTS	

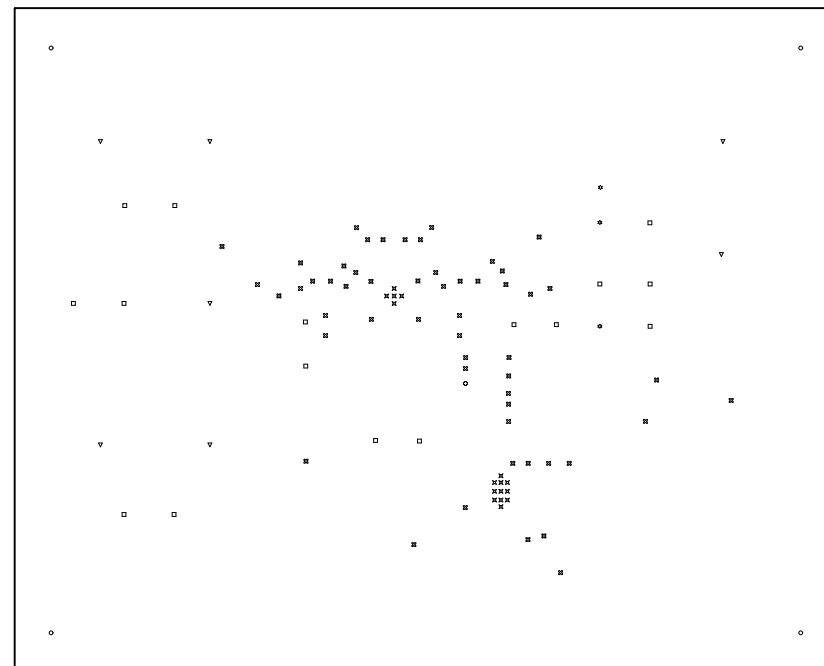

Symbol	Quantity	Finished Hole Size	Plated	Hole Type	Drill Layer Pair	Hole Tolerance
⊗	16	7.87mil (0.200mm)	PTH	Round	Top Layer - Bottom Layer	
⊗	54	10.00mil (0.254mm)	PTH	Round	Top Layer - Bottom Layer	
⊗	1	28.00mil (0.711mm)	PTH	Round	Top Layer - Bottom Layer	
⊗	3	40.00mil (1.016mm)	PTH	Round	Top Layer - Bottom Layer	
□	16	63.00mil (1.600mm)	PTH	Round	Top Layer - Bottom Layer	
○	4	125.98mil (3.200mm)	PTH	Round	Top Layer - Bottom Layer	
▽	7	214.57mil (5.450mm)	PTH	Round	Top Layer - Bottom Layer	
	101 Total					

ALL ARTWORK VIEWED FROM TOP SIDE	BOARD #: PMP15023	REV: E1	SUN REV: Not In VersionControl
LAYER NAME = Drill Drawing	TID #: PMP15023		
PLOT NAME = Drill Drawing	GENERATED : 3/25/2020	2:14:11 PM	TEXAS INSTRUMENTS

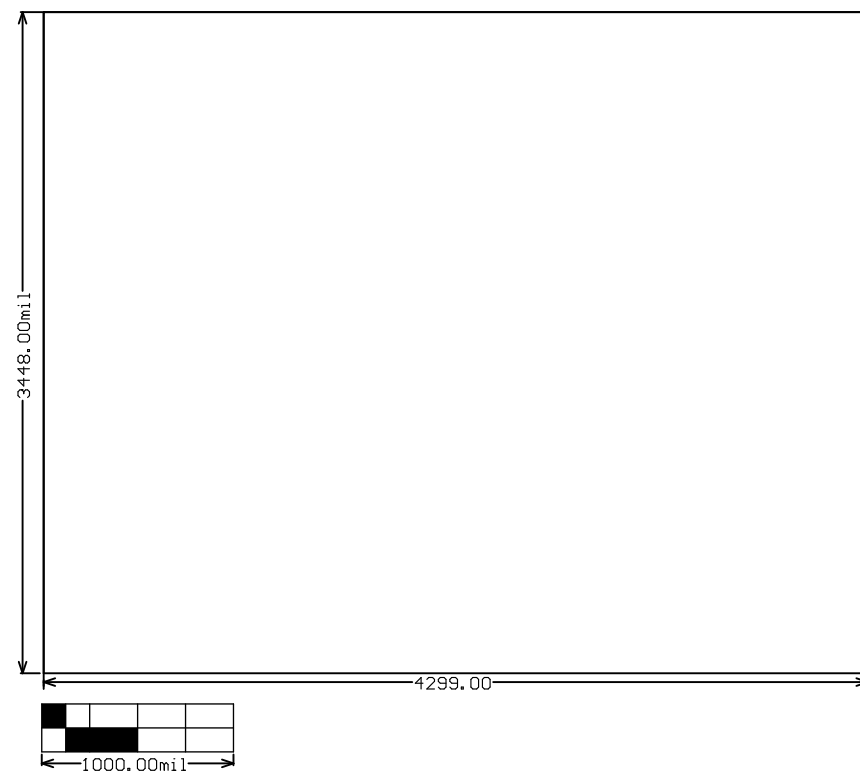

ALL ARTWORK VIEWED FROM TOP SIDE	BOARD #: PMP15023	REV: E1	SUN REV: Not In VersionControl
LAYER NAME = M2 Board Dimensions	TID #: PMP15023		
PLOT NAME = Board Dimensions	GENERATED : 3/25/2020 2:14:13 PM	TEXAS INSTRUMENTS	

IMPORTANT NOTICE AND DISCLAIMER

TI PROVIDES TECHNICAL AND RELIABILITY DATA (INCLUDING DATASHEETS), DESIGN RESOURCES (INCLUDING REFERENCE DESIGNS), APPLICATION OR OTHER DESIGN ADVICE, WEB TOOLS, SAFETY INFORMATION, AND OTHER RESOURCES "AS IS" AND WITH ALL FAULTS, AND DISCLAIMS ALL WARRANTIES, EXPRESS AND IMPLIED, INCLUDING WITHOUT LIMITATION ANY IMPLIED WARRANTIES OF MERCHANTABILITY, FITNESS FOR A PARTICULAR PURPOSE OR NON-INFRINGEMENT OF THIRD PARTY INTELLECTUAL PROPERTY RIGHTS.

These resources are intended for skilled developers designing with TI products. You are solely responsible for (1) selecting the appropriate TI products for your application, (2) designing, validating and testing your application, and (3) ensuring your application meets applicable standards, and any other safety, security, or other requirements. These resources are subject to change without notice. TI grants you permission to use these resources only for development of an application that uses the TI products described in the resource. Other reproduction and display of these resources is prohibited. No license is granted to any other TI intellectual property right or to any third party intellectual property right. TI disclaims responsibility for, and you will fully indemnify TI and its representatives against, any claims, damages, costs, losses, and liabilities arising out of your use of these resources.

TI's products are provided subject to TI's Terms of Sale (www.ti.com/legal/termsofsale.html) or other applicable terms available either on ti.com or provided in conjunction with such TI products. TI's provision of these resources does not expand or otherwise alter TI's applicable warranties or warranty disclaimers for TI products.

Mailing Address: Texas Instruments, Post Office Box 655303, Dallas, Texas 75265
Copyright © 2020, Texas Instruments Incorporated