

AWR1443, AWR1243 Evaluation Module (AWR1443BOOST, AWR1243BOOST) mmWave Sensing Solution

User's Guide



Literature Number: SWRU507C
May 2017–Revised May 2020

1	Getting Started	5
1.1	Introduction.....	5
1.2	Key Features.....	5
1.3	What is Included.....	5
2	Hardware	6
2.1	Block Diagram	7
2.2	Connecting BoosterPack™ to LaunchPad™ or MMWAVE-DEVPACK.....	7
2.3	Power Connections	8
2.4	Connectors	8
2.5	PC Connection	12
2.6	Antenna	13
2.7	Jumpers, Switches, and LEDs	15
3	Design Files and Software Tools	17
3.1	Software, Development Tools, and Example Codes for AWR1443.....	17
4	Design Revision History	18
5	Mechanical Mounting of PCB	18
6	PCB Storage and Handling Recommendations	20
7	Regulatory Information	20
	Revision History	21

List of Figures

1	EVM Front View	6
2	EVM Rear View	6
3	BoosterPack™ Block Diagram	7
4	3V3 and 5-V Mark on the LaunchPad™ (White Triangle)	7
5	Power Connector	8
6	20-Pin BoosterPack™ Connectors (J5 and J6)	8
7	High Density Connector (60 Pin)	10
8	CAN Connector	11
9	XDS110 Ports	12
10	PCB Antenna	13
11	Antenna Pattern in H-Plane	13
12	Antenna Pattern in E-Plane	14
13	SOP Jumpers	15
14	Current Measurement Point	15
15	S1 Switch to Select Between SPI or CAN Interface	17
16	LDO Bypass Enable	18
17	Vertical Assembly of the EVM	19

List of Tables

1	20-Pin Connector Definition (J6)	9
2	20-Pin Connector Definition (J5)	9
3	HD Connector Pin Definition	10
4	SOP Modes	15
5	Push Buttons	16
6	LEDs	16
7	18

AWR1443BOOST, AWR1243BOOST Evaluation Module mmWave Sensing Solution

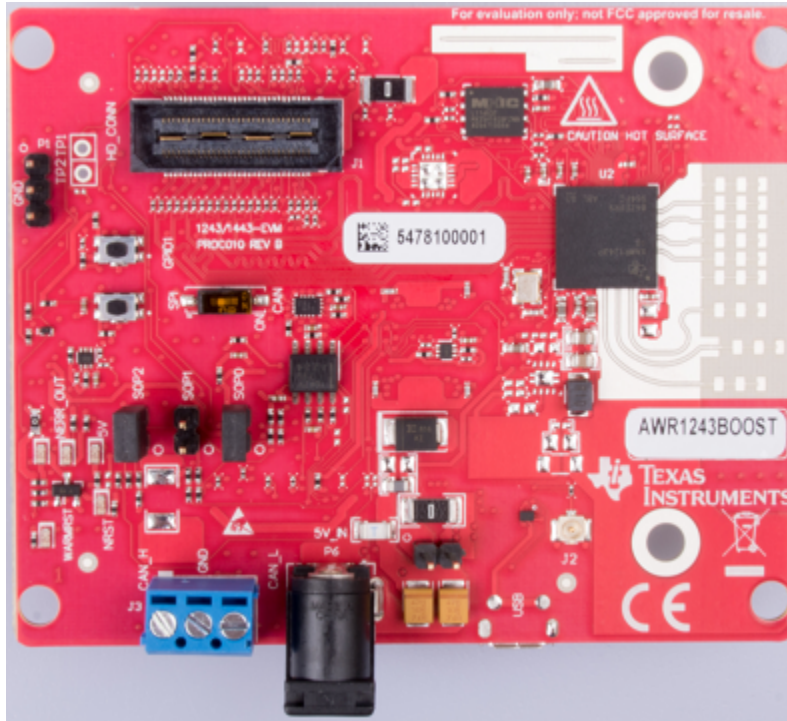

1 ⁽¹⁾⁽²⁾⁽³⁾ Getting Started

1.1 Introduction

The AWR1443 BoosterPack™ is an easy-to-use evaluation board for the single-chip AWR1443 mmWave sensing device from TI, with direct connectivity to the TI MCU LaunchPad™ ecosystem. The evaluation board contains everything needed to start developing on a low-power ARM®-R4F controller. The evaluation board includes onboard emulation for programming and debugging, onboard buttons, and LEDs, for quick integration of a simple user interface. The standard 20-pin BoosterPack headers make the evaluation board compatible with a wide variety of TI MCU LaunchPads and enables easy prototyping.

The AWR1243 BoosterPack is an evaluation board for the AWR1243 mmWave high-performance front end. The evaluation platform enables raw capture of ADC data from the front end and evaluation of RF performance.

1.2 Key Features

- 40-pin LaunchPad standard that leverages the LaunchPad ecosystem
- XDS110-based JTAG emulation with serial port, for onboard QSPI flash programming (for AWR1443)
- Backchannel UART through USB to PC, for logging purposes
- Onboard antenna
- 60-pin high density (HD) connector, for raw ADC data over CSI, or the high-speed debug interface
- Onboard CAN transceiver (for AWR1443)
- One button and two LEDs, for user interaction
- 5-V power jack, to power the board

1.3 What is Included

1.3.1 Kit Contents

- AWR1443BOOST or AWR1243BOOST
- Mounting brackets, screws, and nuts, to allow placing the PCB vertical
- Micro USB cable to connect to the PC

NOTE: *Not included:* 5 V, >2.5-A supply brick with 2.1-mm barrel jack (center positive). TI recommends using an external power supply that complies with applicable regional safety standards such as UL, CSA, VDE, CCC, PSE, and so on. The cable length of the power cord must be < 3 m.

1.3.2 mmWave Proximity Demo

TI provides sample demo codes to easily get started with the AWR1443 evaluation module and experience the functionality of the AWR1443 mmWave sensor. For details on getting started with these demos, see the [mmWave SDK User Guide](#).

⁽¹⁾ BoosterPack, LaunchPad are trademarks of Texas Instruments.

⁽²⁾ ARM is a registered trademark of ARM Limited.

⁽³⁾ Windows is a registered trademark of Microsoft Corporation.

2 Hardware

Figure 1 and Figure 2 show the front and rear views of the evaluation board, respectively.

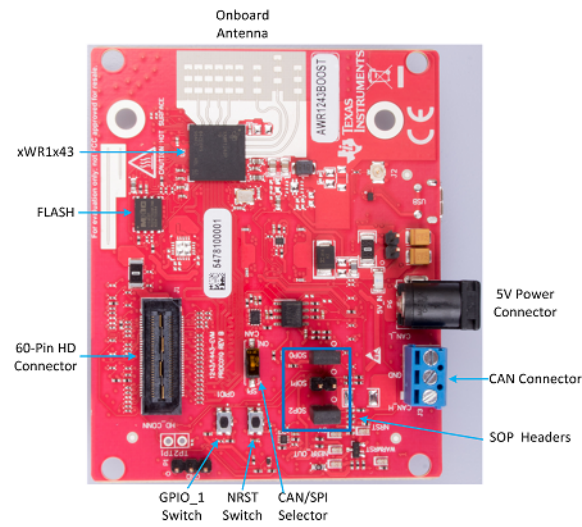

Figure 1. EVM Front View

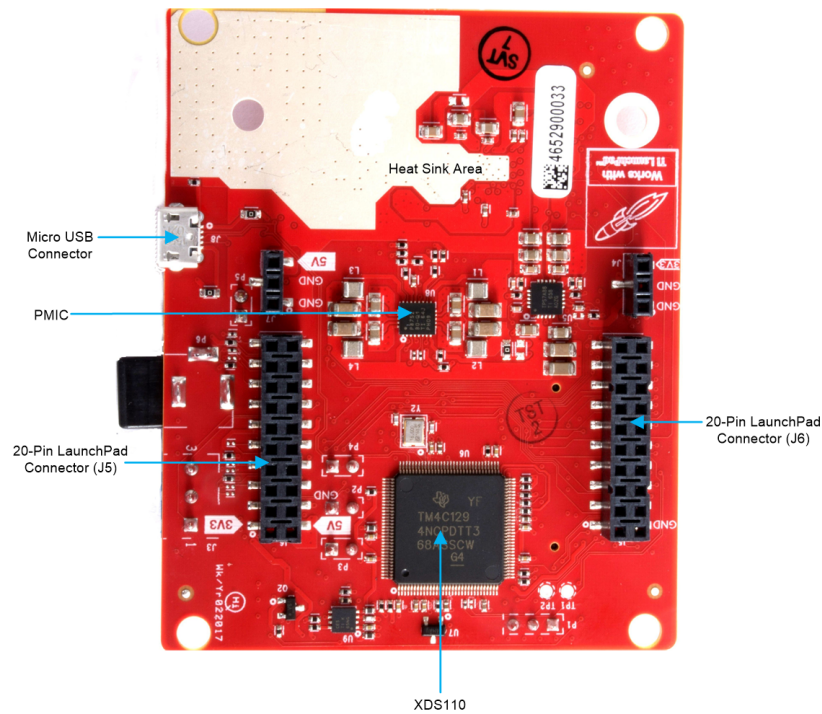

Figure 2. EVM Rear View

2.1 Block Diagram

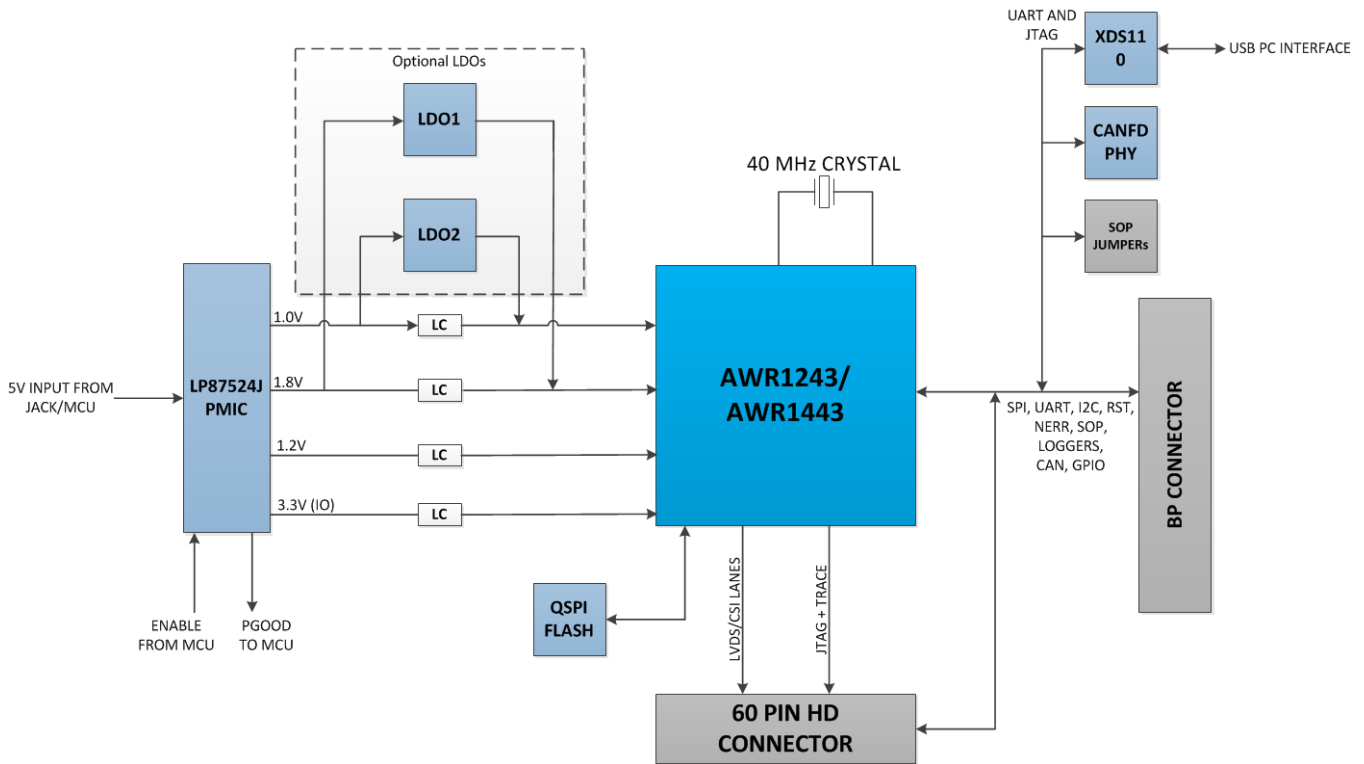

Figure 3. BoosterPack™ Block Diagram

2.2 Connecting BoosterPack™ to LaunchPad™ or MMWAVE-DEVPACK

This BoosterPack can be stacked on top of the Launchpad, or the [MMWAVE-DEVPACK](#), using the two 20-pin connectors. The connectors do not have a key to prevent the misalignment of the pins or reverse connection. Therefore, ensure reverse mounting does not take place. On the AWR1443 BoosterPack, we have provided 3V3 marking near pin 1 (see [Figure 4](#)). This same marking is provided on compatible LaunchPads which must be aligned before powering up the boards.

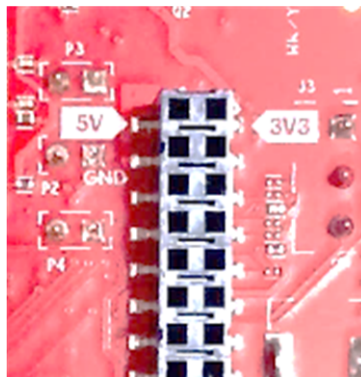

Figure 4. 3V3 and 5-V Mark on the LaunchPad™ (White Triangle)

2.3 Power Connections

The BoosterPack is powered by the 5-V power jack (>2.5-A current limit). As soon as the power is provided, the NRST and 5-V LEDs glow, indicating that the board is powered up (see [Figure 5](#)).

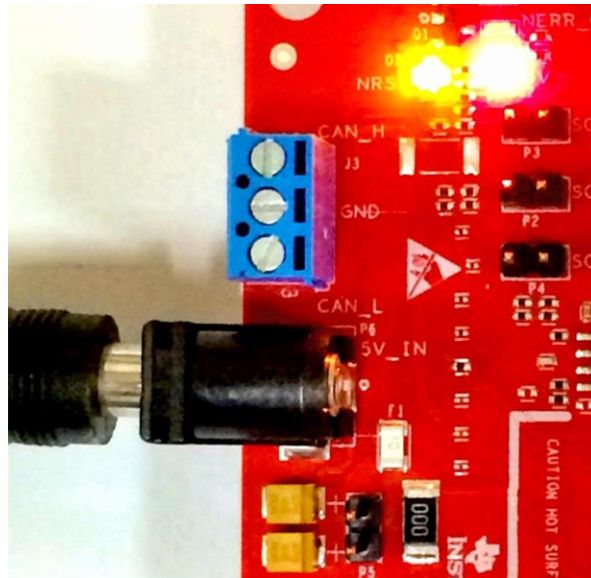

Figure 5. Power Connector

NOTE: After the 5-V power supply is provided to the EVM, TI recommends pressing the NRST switch (SW2) once to ensure a reliable boot up state.

2.4 Connectors

2.4.1 20-Pin BoosterPack™ Connectors

The BoosterPack has the standard LaunchPad connectors (J5 and J6) which enable the BoosterPack to be directly connected to all TI MCU LaunchPads (see [Table 1](#)). While connecting the BoosterPack to other LaunchPads, ensure the pin 1 orientation is correct by matching the 3V3 and 5-V signal marking on the boards (see [Figure 6](#)).

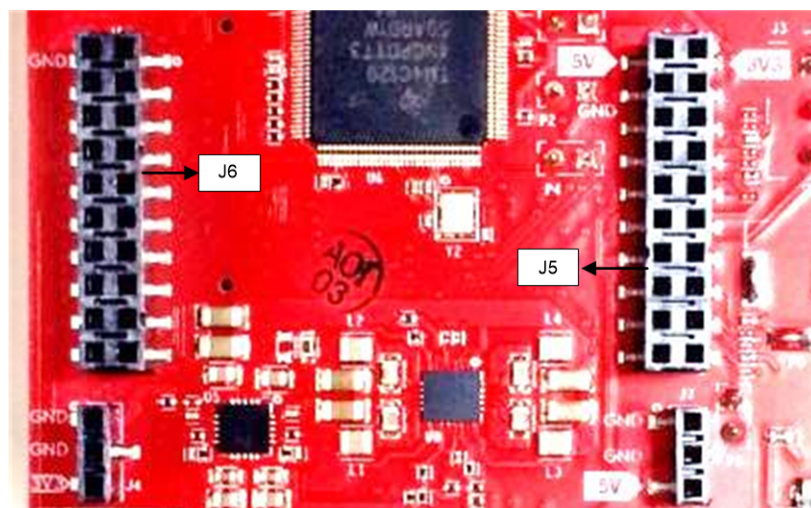

Figure 6. 20-Pin BoosterPack™ Connectors (J5 and J6)

Table 1 and Table 2 provide the connector-pin information.

Table 1. 20-Pin Connector Definition (J6)

Pin Number	Description	Pin Number	Description
1	NERROUT	2	GND
3	NERRIN	4	NC
5	MCUCLK OUT	6	SPI_CS
7	NC	8	GPIO1
9	MSS LOGGER	10	nRESET
11	WARMRST	12	SPI_MOSI
13	BSS LOGGER	14	SPI_MISO
15	SOP2	16	HOSTINT
17	SOP1	18	GPIO2
19	SOP0	20	NC

Table 2. 20-Pin Connector Definition (J5)

Pin Number	Description	Pin Number	Description
1	5 V	2	3V3
3	GND	4	GND
5	ANA1	6	RS232TX (Tx from IWR device)
7	ANA2	8	RS232RX (Rx into IWR device)
9	ANA3	10	SYNC_IN
11	ANA4	12	NC
13	PGOOD (onboard VIO)	14	SPI_CLK
15	PMIC Enable	16	GPIO0
17	SYNC_OUT	18	SCL
19	PMIC CLK OUT	20	SDA

- PGOOD – This signal indicates the state of the onboard VIO supply for the AWR device coming from the onboard PMIC. A high on the PGOOD signal (3.3 V) indicates that the supply is stable. Because the IOs are not failsafe, the MCU must ensure that it does not drive any IO signals to the AWR device before this IO supply is stable. Otherwise, there could be leakage current into the IOs.
- PMIC Enable – This signal goes onboard PMIC enable. The MCU can use this signal to completely shut down the PMIC and AWR device to save power. The power up of the PMIC takes approximately 5 ms once the Enable signal is released.

NOTE: To enable this feature, the R102 resistor must be populated on the EVM.

- ANA1/2/3/4 – These are inputs to the GPADCs (general purpose ADC) available on the AWR1443 device.

2.4.2 60-Pin High Density (HD) Connector

The 60-pin HD connector provides high speed data over CSI or the HS_DEBUG interface, and controls signals (SPI, UART, I2C, NRST, NERR, and SOPs) and JTAG debug signals (see [Table 3](#)). This connector can be connected to the MMWAVE-DEVPACK board and interface with the TSW1400 (see [Figure 7](#)).



Figure 7. High Density Connector (60 Pin)

Table 3. HD Connector Pin Definition

Pin Number	Description	Pin Number	Description
1	5 V	2	5 V
3	5 V	4	TDO
5	TDI	6	TCK
7	SPI_CS	8	TMS
9	SPI_CLK	10	HOSTINT
11	SPI_MOSI	12	SPI_MISO
13	PGOOD (onboard VIO)	14	NERROUT
15	NC	16	SYNC_IN
17	NC	18	GND
19	NC	20	DEBUG_VALIDP
21	NC	22	DEBUG_VALIDM
23	NC	24	GND
25	NC	26	DEBUG_FRCLKP
27	NC	28	DEBUG_FRCLKM
29	NC	30	GND
31	NC	32	DEBUG/CSI_3P
33	NC	34	DEBUG/CSI_3M
35	NC	36	GND
37	NC	38	DEBUG/CSI_2P
39	NC	40	DEBUG/CSI_2M
41	NC	42	GND

Table 3. HD Connector Pin Definition (continued)

Pin Number	Description	Pin Number	Description
43	NC	44	DEBUG/CSI_CLKP
45	NC	46	DEBUG/CSI_CLKM
47	NC	48	GND
49	NC	50	DEBUG/CSI_1P
51	I2C_SDA	52	DEBUG/CSI_1M
53	I2C_SCL	54	GND
55	RS232RX (Rx into AWR device)	56	DEBUG/CSI_0P
57	RS232TX (Tx from AWR device)	58	DEBUG/CSI_0M
59	nRESET	60	GND

PGOOD – This signal indicates that the state of the onboard VIO supply for the AWR device coming from the onboard PMIC. A high on the PGOOD signal (3.3 V) indicates the supply is stable. Because the I/Os are not failsafe, the MCU must ensure that it does not drive any I/O signals to the AWR device before this I/O supply is stable, to avoid leakage current into the I/Os.

2.4.3 CAN Interface Connector (for AWR1443)

The J3 connector provides the CAN_L and CAN_H signals (see [Figure 8](#)) from the onboard CAN transceiver (SN65HVDA540). These signals can be directly wired to the CAN bus.

Because the digital CAN signals (TX and RX) are muxed with the SPI interface signals on the AWR device, one of the two paths must be selected. This is done by placing the switch S2 on the "CAN" position.

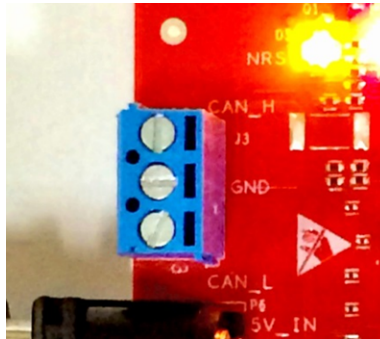
Figure 8. CAN Connector

2.5 PC Connection

Connectivity is provided using the micro USB connector over the onboard XDS110 (TM4C1294NCPDT) emulator. This connection provides the following interfaces to the PC:

- JTAG for CCS connectivity
- UART1 for flashing the onboard serial flash, downloading FW using RADAR studio, and getting application data sent over the UART
- MSS logger UART, which can be used to get MSS code logs on the PC

When the USB is connected to the PC the device manager recognizes the following COM ports, as shown in [Figure 9](#):

- XDS110 Class Application/User UART → the UART1 port
- XDS110 Class Auxiliary Data port → the MSS logger port

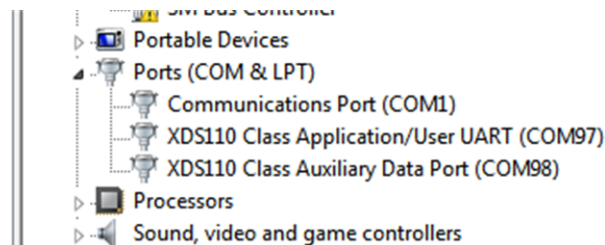

Figure 9. XDS110 Ports

If Windows® is unable to recognize the COM ports previously shown, install the emupack available [here](#)

2.5.1 Erasing Onboard Serial Flash

Before loading the code to the serial flash or connecting the board to RADAR Studio, TI recommends completely erasing the onboard serial flash. The instructions to erase the onboard serial flash are in the [mmWave SDK User Guide](#).

2.5.2 Connection With MMWAVE-DEVPACK

Mmwave SDK demos and released labs do not require the DevPack to be used with the BoosterPack. Users may be required to use the DevPack along with the BoosterPack for the following use cases:

- Connecting to RADAR studio. This tool provides capability to configure the mmWave front end from the PC. This tool is available in the [DFP package](#).
- Capturing high-speed LVDS data using the TSW1400 platform from TI. This device allows the user to capture raw ADC data over the high-speed debug interface and post process it in the PC. The RADAR Studio tool provides an interface to the TSW1400 platform as well, so that the front end configurations and data capture can be done using a single interface. Details on this board can be found at <http://www.ti.com/tool/tsw1400evm>

For details on these use cases, see the [mmWave-DevPack User Guide](#).

2.5.3 Connecting the BoosterPack to the DCA1000

The BoosterPack can be connected to the DCA1000 FPGA platform for LVDS streaming over Ethernet. For detailed information on how to capture LVDS data using the DCA1000, see the following resources:

- [DCA1000 Product Page](#)
- [DCA1000 User's Guide](#)
- [DCA1000 Training Video](#)

2.6 Antenna

The BoosterPack includes onboard etched antennas for the four receivers and three transmitters, which enables tracking multiple objects with their distance and angle information. This antenna design enables estimation of both azimuth and elevation angles, which enables object detection in a 3-D plane (see Figure 10).

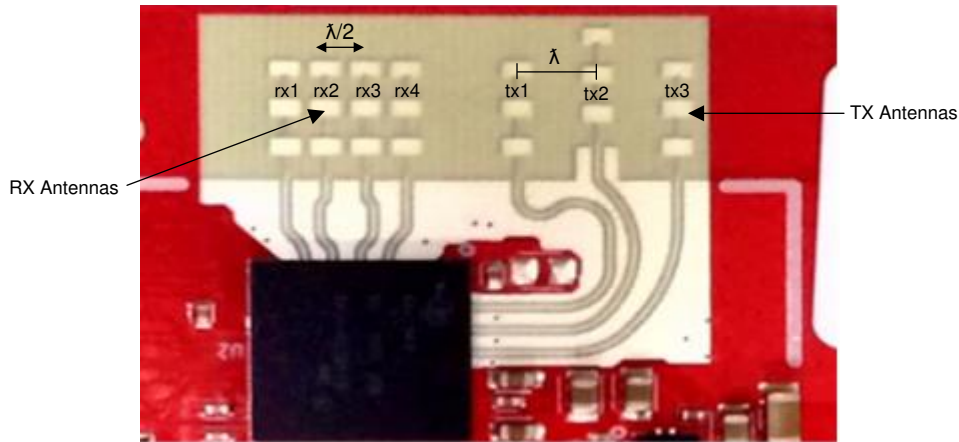

Figure 10. PCB Antenna

The antenna peak gain is > 10.5 dBi across the frequency band of 76 to 81 GHz. The radiation pattern of the antenna in the horizontal plan (H-plane) and elevation plan (E-plane) is as shown in Figure 11 and Figure 12.

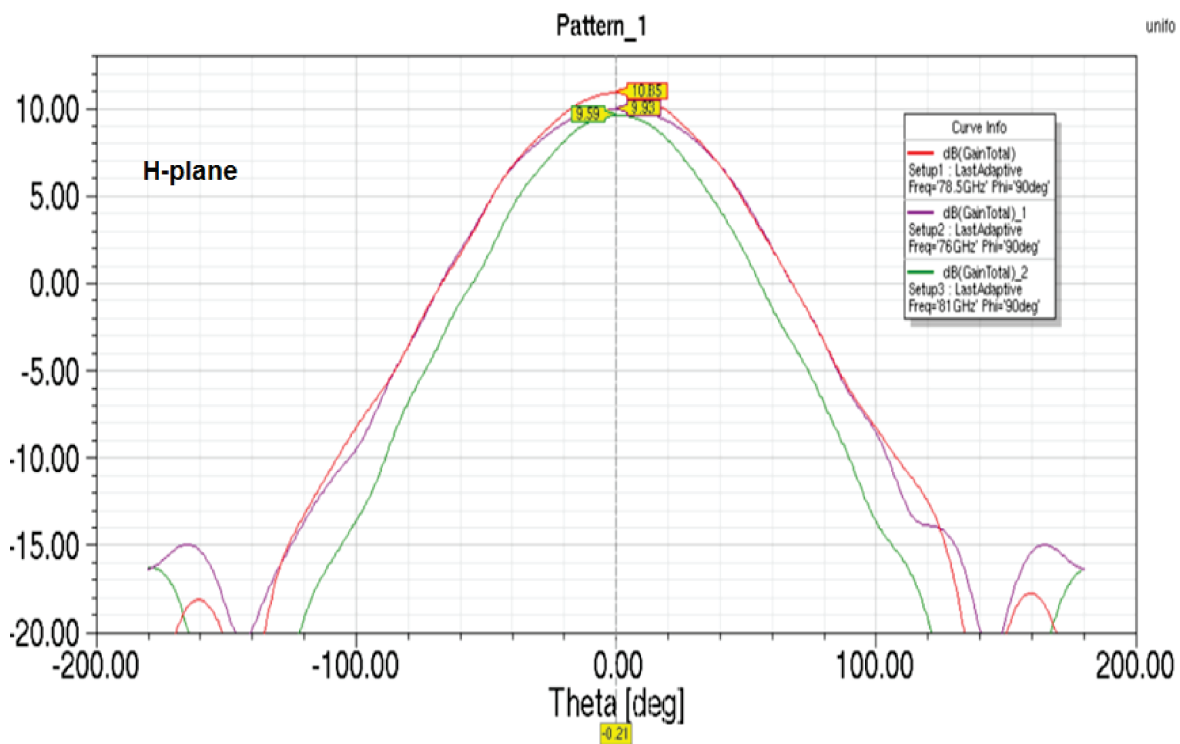

Figure 11. Antenna Pattern in H-Plane

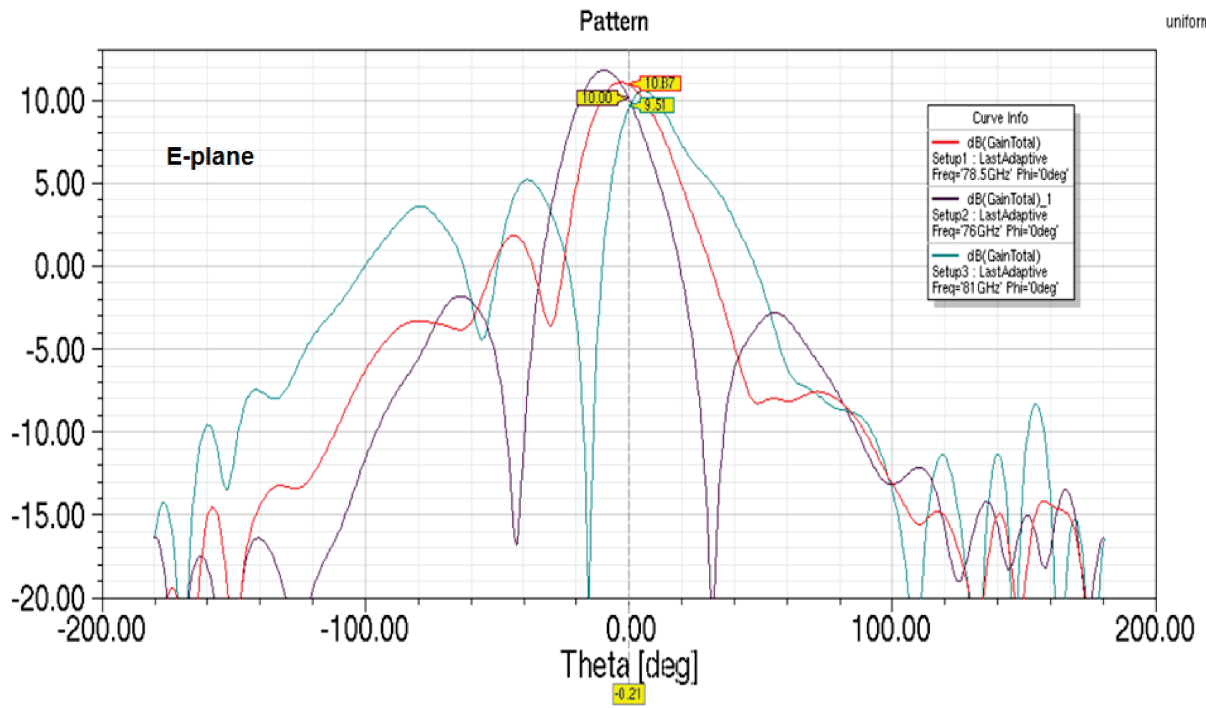

Figure 12. Antenna Pattern in E-Plane

2.7 Jumpers, Switches, and LEDs

2.7.1 Sense On Power Jumpers

The AWR1443 and AWR1243 devices can be set to operate in three different modes, based on the state of the SOP (sense on power) lines (see [Figure 13](#)). These lines are *only* sensed during boot up of the AWR device. The state of the device is described by [Table 4](#).

A closed jumper refers to a 1 and an open jumper refers to a 0 state of the SOP signal going to the AWR device.

Table 4. SOP Modes

Reference	Use	Comments
P3 (SOP 2)	SOP[2:0]	101 (SOP mode 5) = Flash programming
P2 (SOP 1)		001 (SOP mode 4) = Functional mode
P4 (SOP 0)		011 (SOP mode 2) = Dev mode



Figure 13. SOP Jumpers

2.7.2 Current Measurement

The P5 jumper enables measurement of the current being consumed by the reference design (AWR device + PMIC + LDOs) at the 5-V level.

To measure the current, R118 must be removed and a series ammeter can be put across the P5 pins (see [Figure 14](#)).



Figure 14. Current Measurement Point

2.7.3 Push Buttons and LEDs

Table 5 and Table 6 list the push button and LED uses, respectively.

Table 5. Push Buttons







Reference	Use	Comments	Image
SW2	RESET	<p>This button is used to reset the radar device. This signal is also brought out on the 20-pin connector and 60-pin HD connector, so that an external processor can control the AWR device.</p> <p>The onboard XDS110 can also use this reset.</p>	
SW1	GPIO_1	<p>When this button is pushed, the GPIO_1 is pulled to V_{cc}.</p>	

Table 6. LEDs

Reference	Color	Use	Comments	Image
DS2	Red	5-V supply indication	This LED indicates the presence of the 5-V supply.	
DS4	Yellow	nRESET	This LED is used to indicate the state of nRESET pin. If this LED is on, the device is out of reset. This LED glows only after the 5-V supply is provided.	
DS1	Red	NERR_OUT	This LED turns on if there is any hardware error in the AWR device.	
DS3	Yellow	GPIO_1	This LED turns on when the GPIO is logic-1.	

2.7.4 Selection Between SPI and CAN Interface

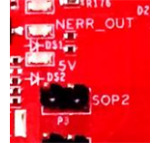
The SPI and CAN interface are muxed on the same lines on the AWR1243BOOST. Based on the configuration, the user can select if the pins P5 and R8 must be connected to the 20-pin/HD connectors to provide the SPI interface OR the on board CAN PHY (U3). This selection is done by setting the S1 switch.



Figure 15. S1 Switch to Select Between SPI or CAN Interface

3 Design Files and Software Tools

For Rev A boards:

- [AWR1243BOOST Schematics, Assembly, and BOM Details](#)
- [AWR1243BOOST Design Database and Layout Details](#)
- [AWR1443BOOST Schematics, Assembly and BOM Details](#)
- [AWR1443BOOST Design Database and Layout Details](#)

For Rev B boards:

- [AWR1243BOOST Schematics, Assembly, and BOM Details](#)
- [AWR1443BOOST Schematics, Assembly and BOM Details](#)
- [AWR1x43BOOST Design Database and Layout Details](#)

NOTE: Boards with a Rev 'C' sticker have had capacitor C56 (VBGAP decoupling capacitor) changed from 0.22 μ F to 0.047 μ F (part number CGA2B3X7R1H473K050BB). TI recommends that customers incorporate this change with an equivalent capacitor in their designs.

3.1 Software, Development Tools, and Example Codes for AWR1443

To enable quick development of an end application on the R4F core in the AWR1443, TI provides a software development kit (SDK) which includes demo codes, software drivers, an emulation package for debug, and so on. The SDK is available at [mmwave-sdk](#).

3.1.1 LDO Bypass Requirement

The AWR1243BOOST and AWR1443BOOST use a 1.0-V supply on the RF1 and RF2 power rails. To support the third transmitter, the VOUT_PA output is connected to the RF2 power rail. For best performance and to prevent damage to the device, select the 'RF LDO Bypass Enable' and 'PA LDO I/P Disable' options in the Static Configuration when using mmWave Studio. Additionally, the LDO bypass can be configured using the AWR_RF_LDO_BYPASS_SB API. To enable the RF LDO Bypass and PA LDO I/P Disable through the API, issue an `ar1.RfLdoBypassConfig(0x3)` command.

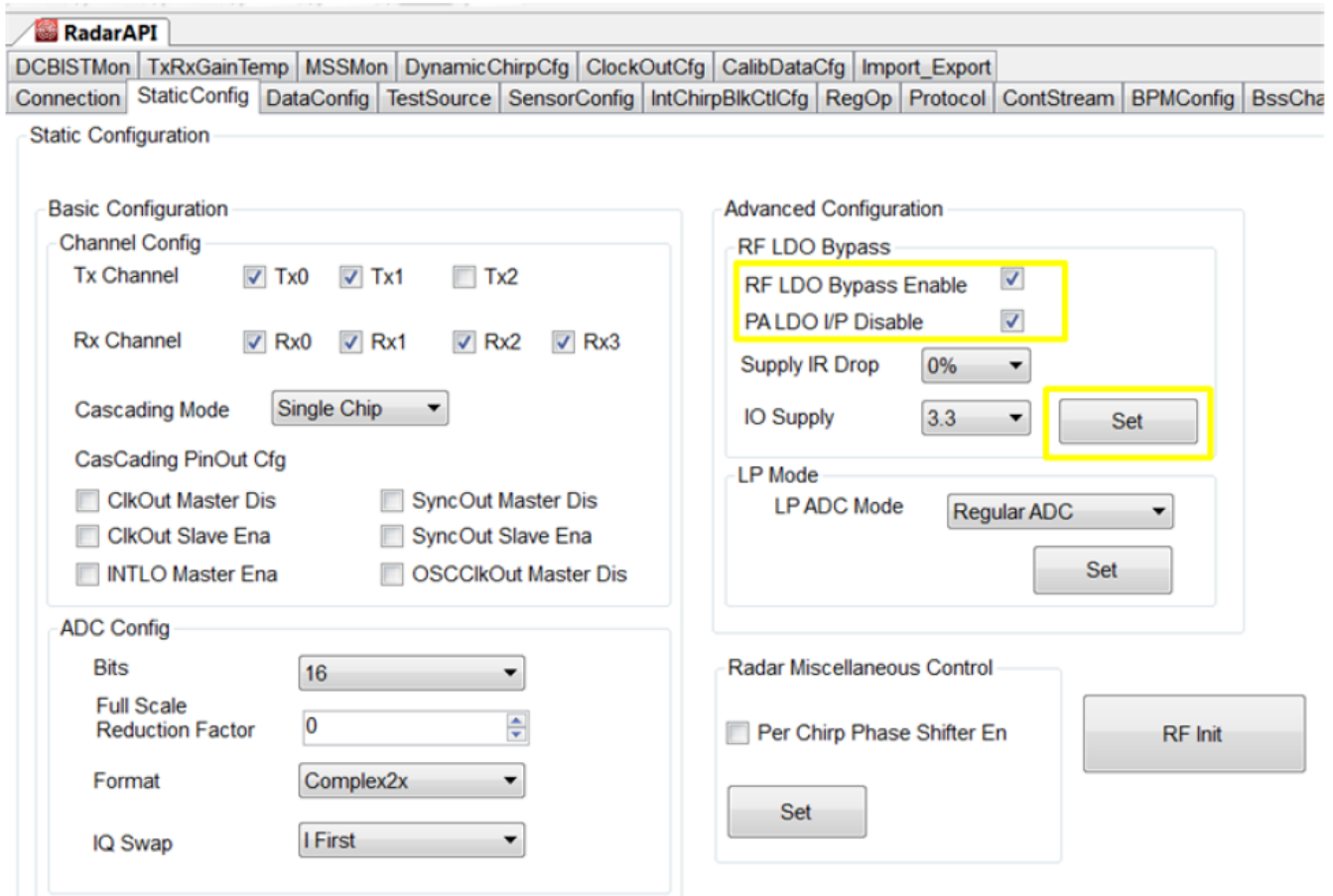

Figure 16. LDO Bypass Enable

4 Design Revision History

Table 7.

PCB Revision	Notes
B	Added switch control to move between SPI and CAN interface
	Enabled, by default, the 5-V supply from the 60-pin HD connector
	Enabled, by default, the SYNC_IN signal connection to the J6 connector
	Serial flash part number updated to MX25V1635FZNQ
	Added series resistors on I2C lines
	Removed the series diode on the NRST signal
	Enabled, by default, the LDO bypass option

5 Mechanical Mounting of PCB

The field of view of the radar sensor is orthogonal to the PCB. The L-brackets provided with the AWR1443 and AWR1243 EVM kit, along with the screws and nuts help in the vertical mounting of the EVM. [Figure 17](#) shows how the L-brackets can be assembled.

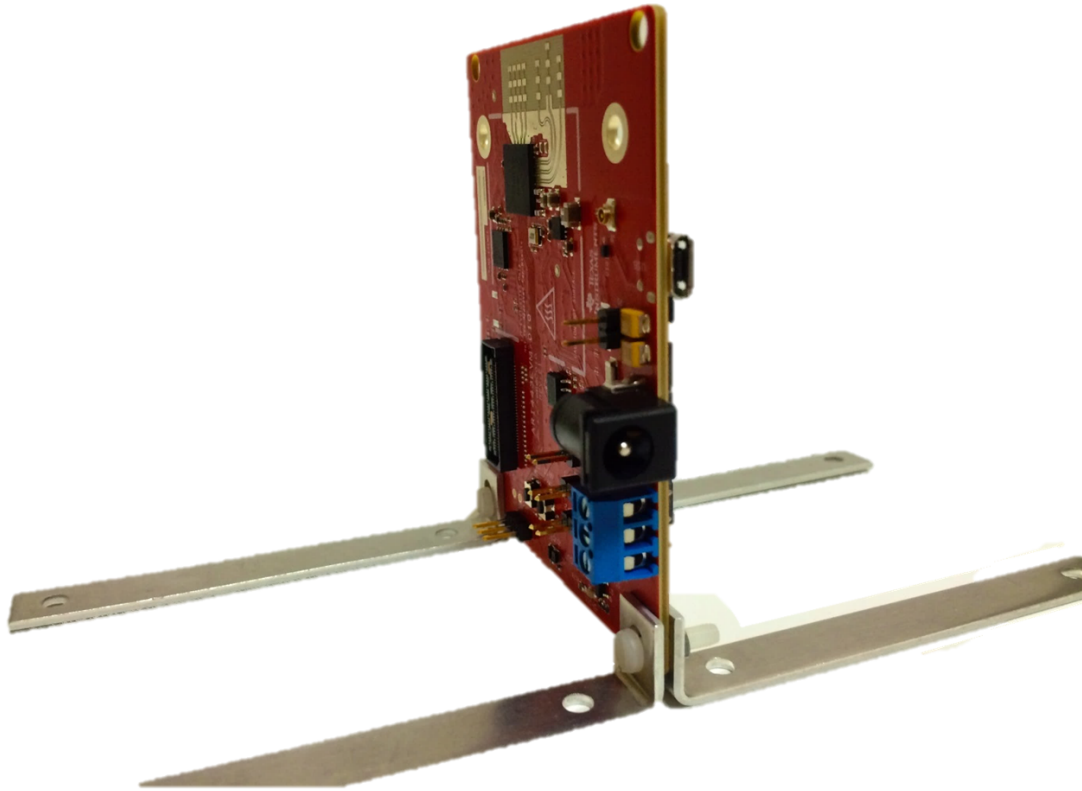

Figure 17. Vertical Assembly of the EVM

6 PCB Storage and Handling Recommendations

The immersion silver finish of the PCB provides a better high-frequency performance but is also prone to oxidation in an open environment. This oxidation causes the surface around the antenna region to blacken. To avoid this effect, store the PCB in an ESD cover and keep it at controlled room temperature with low humidity conditions. All ESD precautions must be taken while using and handling the EVM.

7 Regulatory Information

The AWR1443 and AWR1243 evaluation modules (AWR1443BOOST and AWR1243BOOST) are in compliance with Directive 2014/53/EU. The full text of TI's EU Declaration of Conformity is available [here](#).

The compliance has been verified in the operating bands 76 – 77 GHz and 77 – 81 GHz. Should the user choose to configure the EVM to operate outside the test conditions, it should be operated inside a protected or controlled environment, such as a shielded chamber. This evaluation board is intended only for development, and is not for use in an end product or part of an end product. Developers and integrators that incorporate the chipset in any end products are responsible for obtaining applicable regulatory approvals for such an end product.

The European RF exposure radiation limit is fulfilled if a minimum distance of 5 cm between the users body and the radio transmitter is respected.

NOTE: The EUT has been tested in the 76 – 77 GHz band (2 Tx at a time) at a maximum peak power of 26 dBm EIRP, and in the 77 – 81 GHz band (1 Tx at a time) with maximum peak power of 21 dBm EIRP across the temperature range of –20°C to 60°C.

Revision History

NOTE: Page numbers for previous revisions may differ from page numbers in the current version.

Changes from B Revision (January 2019) to C Revision	Page
• Updated J5 and J6 20-Pin Connector Definition tables.	9
• Added Note.	17

IMPORTANT NOTICE AND DISCLAIMER

TI PROVIDES TECHNICAL AND RELIABILITY DATA (INCLUDING DATA SHEETS), DESIGN RESOURCES (INCLUDING REFERENCE DESIGNS), APPLICATION OR OTHER DESIGN ADVICE, WEB TOOLS, SAFETY INFORMATION, AND OTHER RESOURCES "AS IS" AND WITH ALL FAULTS, AND DISCLAIMS ALL WARRANTIES, EXPRESS AND IMPLIED, INCLUDING WITHOUT LIMITATION ANY IMPLIED WARRANTIES OF MERCHANTABILITY, FITNESS FOR A PARTICULAR PURPOSE OR NON-INFRINGEMENT OF THIRD PARTY INTELLECTUAL PROPERTY RIGHTS.

These resources are intended for skilled developers designing with TI products. You are solely responsible for (1) selecting the appropriate TI products for your application, (2) designing, validating and testing your application, and (3) ensuring your application meets applicable standards, and any other safety, security, regulatory or other requirements.

These resources are subject to change without notice. TI grants you permission to use these resources only for development of an application that uses the TI products described in the resource. Other reproduction and display of these resources is prohibited. No license is granted to any other TI intellectual property right or to any third party intellectual property right. TI disclaims responsibility for, and you will fully indemnify TI and its representatives against, any claims, damages, costs, losses, and liabilities arising out of your use of these resources.

TI's products are provided subject to [TI's Terms of Sale](#) or other applicable terms available either on ti.com or provided in conjunction with such TI products. TI's provision of these resources does not expand or otherwise alter TI's applicable warranties or warranty disclaimers for TI products.

TI objects to and rejects any additional or different terms you may have proposed.

Mailing Address: Texas Instruments, Post Office Box 655303, Dallas, Texas 75265
Copyright © 2022, Texas Instruments Incorporated