

# Detection of Plunger Movement in DC Solenoids



## **Manu Balakrishnan**

System Engineer  
Motor Drives  
Texas Instruments

## **Navaneeth Kumar N**

System Architect  
Motor Drives  
Texas Instruments

# Abstract

---

The detection of the plunger movement in solenoids is required to ensure proper operation of the solenoid actuator. This paper proposes a method to detect the movement of plunger in a solenoid by sensing the solenoid current. The solenoid excitation current have a prominent dip during power up due to the back EMF generated by plunger movement. The solenoid current dip due to back EMF remains constant irrespective of the temperature. The solution proposed in this paper utilizes this characteristic of the solenoid current in detecting the movement of the plunger in the solenoid valve. Absolute difference in current dip is measured and is used to define the threshold for detection of plunger movement. The detection logic circuit senses the solenoid current and when the current drops below the predefined threshold, it will be interpreted as the end of plunger movement. The proposed method is validated at different temperatures.

## I. Introduction

---

Electromechanical solenoids are used in valves, relays and contactors. Solenoid coils are rated to operate from 12-V to 24-V DC and 110-V to 230-V AC systems with a power consumption ranging from 8 to 20 W<sup>[7]</sup>. Electromechanical solenoids consist of an electromagnetically inductive coil wound around a movable steel or iron slug called the armature, or plunger<sup>[9]</sup>. Solenoid coils need more current only during actuation, called the pull in current, to pull the plunger into the solenoid. However once the solenoid is actuated, the solenoid coil needs approximately 30% of its nominal current, called the hold current, to keep the plunger in the same position<sup>[7]-[9]</sup>. Solenoid coils operating with nominal current consistently raise the temperature in the coil due to higher power dissipation. Once the plunger movement is detected, the steady state current can be reduced to the hold current value to minimize the power dissipation in the solenoid. The

detection of the plunger movement is required to ensure the proper operation of the valve, relays or contactors.

There are different methods and algorithms available in the literature, to detect the movement of plunger in solenoids. The use of Hall sensors is explained in [3], [4]. However Hall sensors may fail to detect the faulty or slow movement of the plunger. Some algorithms use the excitation current profile of the solenoid<sup>[5], [6]</sup> to detect the proper operation of solenoids. However the current profile depends on the working temperature of the solenoids. These methods may fail to detect the faulty operation of solenoids during temperature variation.

This paper proposes a method to detect the movement of the plunger in solenoid which is immune to temperature variation. The method utilizes the current profile of the solenoid due to motion Back EMF to detect the plunger movement. In this paper modeling and characterization of solenoids is explained in section II. The effect of

temperature variation on solenoid characteristics is evaluated. The different plunger movement detection methods are detailed in section III. The proposed method and the experiment results showing the performance of the proposed method at different temperature are also covered.

## II. Modeling and characterization of solenoid coils

Linear solenoids are electromechanical devices which convert electrical energy into a linear mechanical motion which is used to control an electrical or pneumatic or hydraulic system. Figure 1 shows the cross sectional view of an electromagnetic solenoid. The solenoid consists of an electromagnetically inductive coil wound around a movable armature, or plunger. The coil is shaped such that the armature can be moved in and out of its center, altering the coil's inductance<sup>[9]</sup>. The plunger provides mechanical force to activate the control mechanism, for example opening and closing of a valve.

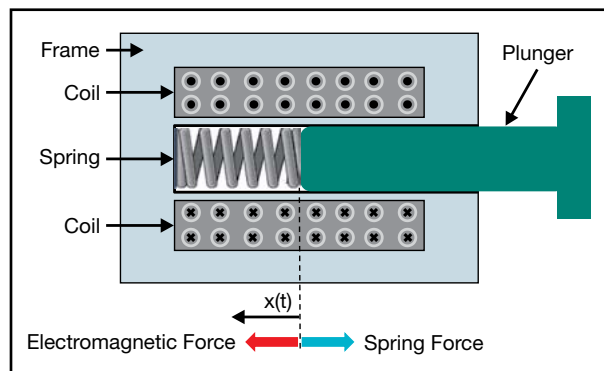

Figure 1: Cross sectional view of an electromagnetic solenoid

The solenoid is operated by applying an excitation voltage to the electrical terminals of the solenoid. This voltage builds up current in the solenoid

winding. This current produces a magnetic flux that closes through the solenoid's housing, plunger and air gaps which form a magnetic circuit. The magnetic field, through the main air gap, exerts an attractive force on the plunger intent to pull it inside the housing.

In general a typical solenoid consists of an electromagnetic system and a mechanical system. The electromagnetic system converts applied voltage to magnetizing current which in turn produces an electromagnetic force. The mechanical system consists of the plunger and return spring producing the linear movement due to the electromagnetic force.

### A. Mathematical modeling of the solenoids

The simplified electrical equation of a solenoid can be written as in (1).

$$V = iR + \frac{d\Psi(i,x)}{dt} \quad (1)$$

Where  $V$  is the applied voltage,  $R$  is the coil resistance and  $\Psi$  is the flux linkage. The first term of the equation refers to the resistive drop and the second term is the induced voltage<sup>[1], [2]</sup>. The inductance of the coil depends on the position of the plunger ( $x(t)$ ) since the magnetic reluctance of the solenoid depends on the plunger position. Therefore the flux linkage in the coil depends on the current in the coil and the position of the plunger. Equation (1) can be expanded to obtain (2).

$$V = iR + \frac{\delta\Psi(i,x)}{\delta i} \cdot \frac{di}{dt} + \frac{\delta\Psi(i,x)}{\delta x} \cdot \frac{dx}{dt} \quad (2)$$

Substituting  $\Psi = Li$

$$V = iR + L(i,x) \cdot \frac{di}{dt} + i \cdot \frac{dL(i,x)}{dx} \cdot \frac{dx}{dt} \quad (3)$$

The third term in (2) and (3) refers to the motional back EMF (electromotive force), a voltage induced

due to reluctance changes by plunger movement<sup>[1], [2]</sup>.

The electromagnetic force on the plunger is the gradient of the accumulated energy in the working air gap and core of the solenoid. The developed electromagnetic force depends on the solenoid current and the inductance gradient<sup>[2]</sup>.

$$F = \frac{\delta E(i,x)}{\delta x} \quad (4)$$

The mechanical model of the solenoid actuator can be expressed by the motion equation which consists of the electromagnetic force developed, force by the return spring, damping, the force exerted by the load on the solenoid (ex: pressure of the fluid through the valve) and any other forces for more accurate model.

## B. Characteristics of solenoid coil

The solenoid is operated by energizing the solenoid coil with an excitation voltage. Figure 2 shows the magnetic flux distribution of the solenoid during the excitation and Figure 3 shows the typical excitation

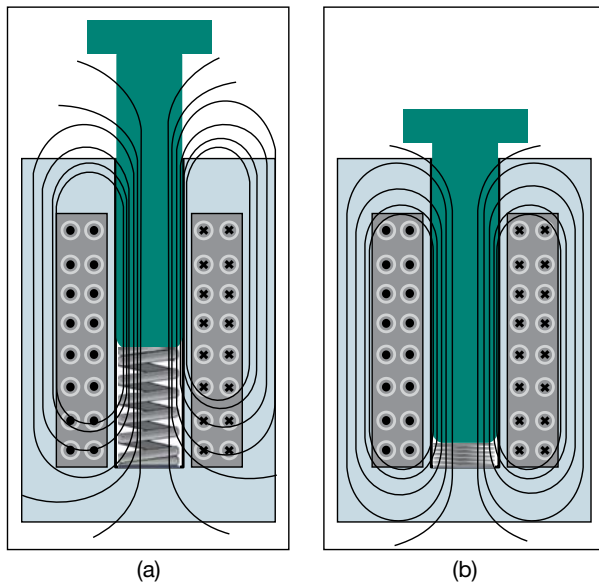

Figure 2(a): Solenoid is energized and the electromagnetic force is strong enough to move the plunger. (b) Plunger moved completely

current characteristics of a solenoid. As soon as the solenoid is energized, the current increases, causing the electromagnetic force to increase until it becomes strong enough to move the plunger and the corresponding magnetic flux distribution is shown in Figure 2(a).

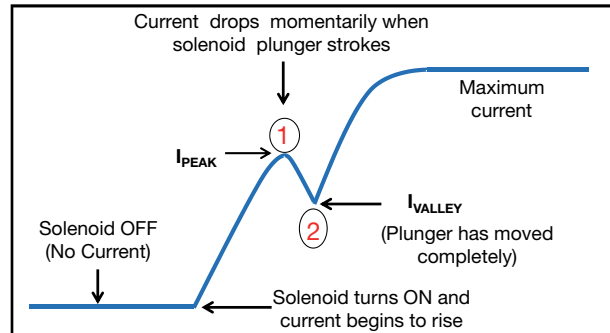

Figure 3: Excitation current characteristics of a solenoid

In Figure 3, at point 1 the plunger starts moving and the corresponding solenoid current is termed as  $I_{PEAK}$ . The plunger movement induces back EMF in the solenoid coil as explained earlier and this causes a brief reduction in the solenoid current. At point 2, the plunger has moved completely and the current gets reduced to  $I_{VALLEY}$ . The corresponding flux distribution in the solenoid is shown in Figure 2(b). After complete movement of the plunger, the solenoid current continues to rise until it reaches its maximum level limited by the coil DC resistance.

## C. Effect of temperature on the solenoid current characteristics

There are different factors which affect the excitation characteristics of solenoid coil like external load on the solenoid, operating temperature, spring tension, damping, friction on the plunger movement path, solenoid mounting orientation and so on.

To study the effect of temperature on the solenoid a typical solenoid is characterized at different temperature. The solenoid current is measured

using a 1  $\Omega$  sense resistor connected in series with the solenoid coil. Figure 4 and Figure 5 show the solenoid current at two extreme temperatures of  $-30^{\circ}\text{C}$  and  $+45^{\circ}\text{C}$ . The curves shift up as the temperature decreases because of the reduction in resistance of the solenoid coil. However the difference between the  $I_{\text{PEAK}}$  and  $I_{\text{VALLEY}}$  currents remains constant across temperature spread. Figure 6 shows the current drawn by the solenoid at different temperatures.

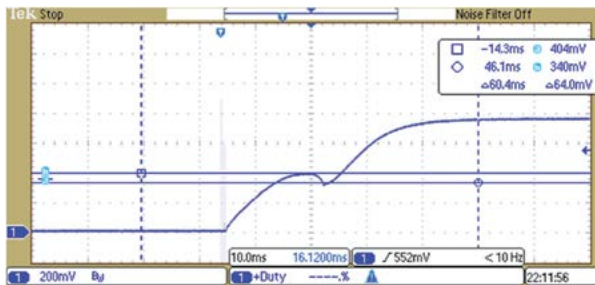

Figure 4: Solenoid current characteristics at  $-30^{\circ}\text{C}$

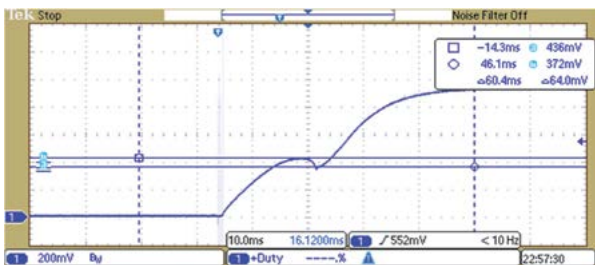

Figure 5: Solenoid current characteristics at  $+45^{\circ}\text{C}$

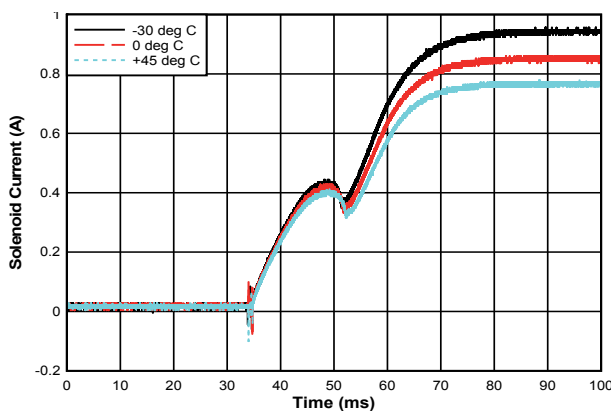

Figure 6: Solenoid current curves at different temperatures

### III. Plunger movement detection in solenoids

Different methods are available in literature to detect the position of the solenoid. Some of the methods and algorithms are explained in following sections.

#### A. Plunger movement detection using Hall sensor

Hall sensors are commonly used to sense the plunger position in the solenoid. The use of Hall sensors is based on the principle that the movement of the plunger causes variation in flux linkage<sup>[3], [4]</sup>. A Hall sensor is used as the sensing device to detect the magnetic flux density produced by the solenoid coil and hence the output of a Hall sensor is proportional to the position of the plunger. The Hall sensor will be mounted at a suitable place to detect the variation in flux linkage.

There are some drawbacks if a Hall sensor is used for detecting the plunger position. The mechanical mounting of these sensors are complex and their performance is affected by aging. In a faulty solenoid the plunger movement can be slow due to any factors like friction, rusting, etc. However the Hall sensor will provide a signal at the end of the plunger movement. Hence using a Hall sensor cannot detect such slow or faulty movement of the plunger.

#### B. Plunger movement detection using the excitation current profile of the solenoid

In literature, various solutions have been proposed which utilizes the excitation current profile of the solenoid for detecting the proper movement of a solenoid.

The solenoid plunger position detection algorithm described in [5] makes use of the solenoid

characterization data. The current required to start the movement of the plunger, the current at the end of plunger movement and the corresponding time obtained during solenoid characterization are stored in the controller as predetermined values. During normal operation the measured time and actuating current values are compared with the predetermined values. The difference between the measured and predetermined values is used to decide the proper functioning of the solenoid.

There are algorithms which measure the slope of the excitation current profile of the solenoid<sup>[6]</sup>. The inductance of the solenoid depends on the plunger position. Therefore the slope of the current curve before and after the plunger movement will be different. The algorithm explained in [6] measures the slope of the current curve at three different instances and compared to detect the position of the plunger.

These algorithms are not addressing the effect of temperature variation on the solenoid characteristics.

### C. Plunger movement detection using fixed reference for peak and valley current

This is another plunger movement detection method utilizing solenoid current profile. The detection logic uses two comparators with fixed references for detecting peak and valley current. The plunger will be characterized at one temperature  $T_1$  (Figure 7) to obtain  $I_{PEAK}$  and  $I_{VALLEY}$ , and these values are used as the reference thresholds for the comparators. Comparaor1 has reference threshold of  $I_{PEAK}$  and when the solenoid current reaches  $I_{PEAK}$  the comparator1 output becomes high. Comparator2 will be enabled when comparator 1 output reaches high. Comparator2 reference is  $I_{VALLEY}$  and when the solenoid current dips to  $I_{VALLEY}$  comparator2

output becomes high and this signal is used as the indication signal for movement of the plunger. However as the temperature changes, the solenoid curves shifts up or down, which changes  $I_{PEAK}$  and  $I_{VALLEY}$  and hence the comparator may not detect the proper plunger movement. In short, pre-fixing the threshold may fail to detect the plunger operation properly with temperature variation.

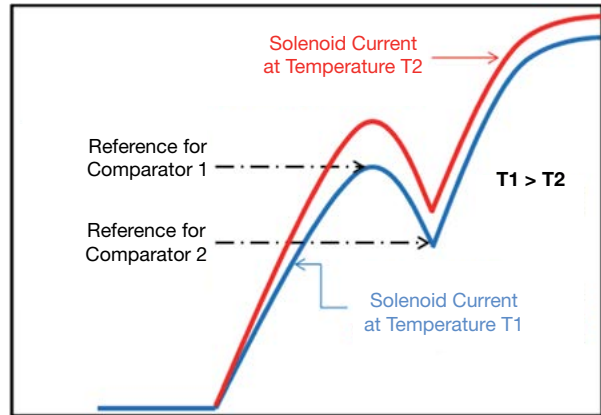

Figure 7: Fixed references for peak and valley current

## IV. Proposed method of plunger movement detection

The proposed method to detect the plunger movement utilizes the excitation current profile of the solenoid. This method is derived by characterizing the solenoid at different temperatures. Figure 6 shows the current drawn by the solenoid at different temperatures. The curves shift up as the temperature decreases because of the reduction in resistance of the solenoid. But it can be noticed that the difference between the peak and valley of the solenoid current dip due to back EMF remains constant irrespective of the temperature. This characteristic of the solenoid current is utilized

in detecting the movement of the plunger of the solenoid valve.

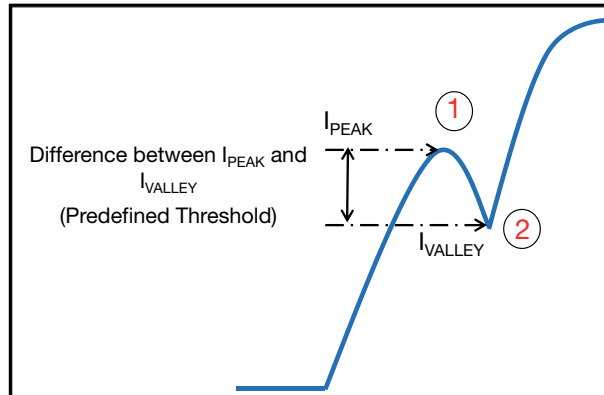

Figure 8: Threshold using absolute difference between  $I_{PEAK}$  and  $I_{VALLEY}$

Absolute difference between  $I_{PEAK}$  and  $I_{VALLEY}$  (as shown in Figure 8) is measured and is used to define the threshold for detection of plunger movement. The threshold is set slightly above  $I_{VALLEY}$  and is referenced to  $I_{PEAK}$  so as to make the detection circuit immune to temperature variation.

Figure 9 shows a typical solenoid driver circuit. The solenoid current controller is used to control the peak and hold current of the solenoid by using a switching device like BJT or MOSFET<sup>[8]</sup>.

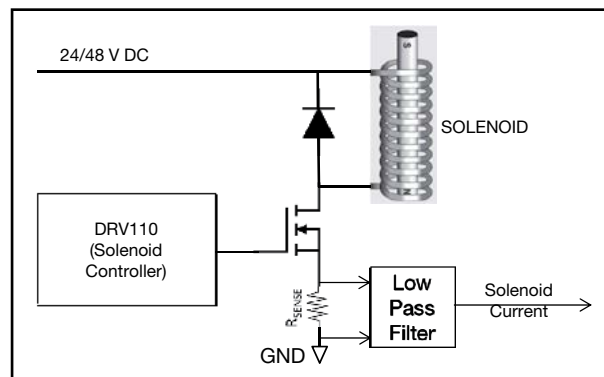

Figure 9: A typical solenoid driver with current sensing

Figure 10 shows the block diagram of the plunger movement detection circuit consisting of an

amplifier, active peak detector, op-amp adder and a comparator. The detection logic is implemented by simple op-amp circuits rather than using a sensor or controller.

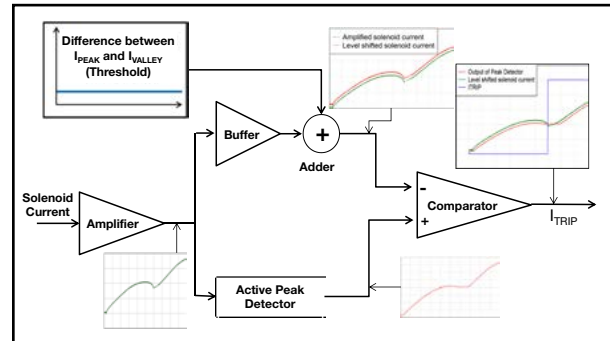

Figure 10: Block diagram of the proposed method of plunger movement detection

The solenoid current is detected using a sense resistor. The voltage across the sense resistor is amplified by the op-amp and is fed simultaneously to the active peak detector and the level shifter consisting of buffer and op-amp adder circuit.

Figure 11, on the following page, shows the waveforms at different nodes in the plunger position detection circuit. The peak detector output tracks the solenoid current till point 1, where the solenoid plunger starts moving. After this point the solenoid current decreases because of the back EMF and the current dips to point 2. But the output of the peak detector will remain to a value equal to the peak value at point 1, and is fed to the non-inverting input of the comparator.

The amplified solenoid current is level shifted by adding the predefined threshold, the absolute difference between  $I_{PEAK}$  and  $I_{VALLEY}$ . The inverting input of the comparator is fed with level shifted solenoid current.

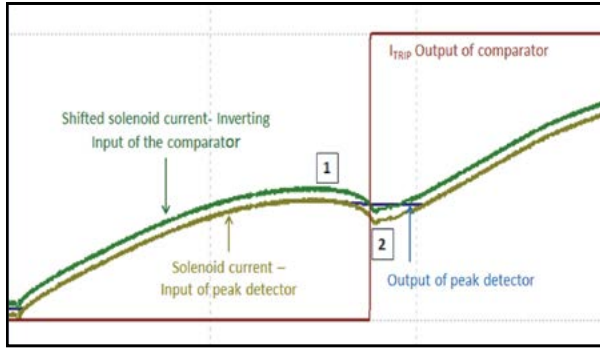

Figure 11: Waveforms at different nodes in the proposed plunger movement detection circuit

The output of the comparator  $I_{TRIP}$  goes high and is latched when the level-shifted current falls below the peak detector output. When the solenoid is faulty or didn't move or moved slowly, the solenoid current will not have a dip or dip of sufficient magnitude to fall lower than the predefined threshold set by the circuit parameters and hence the output of the comparator  $I_{TRIP}$  will be always low.

The absolute difference between  $I_{PEAK}$  and  $I_{VALLEY}$  (threshold) varies with different types of solenoid. In the proposed circuit the threshold is set by using a resistive divider. Therefore with different types of solenoid, based on the absolute difference between  $I_{PEAK}$  and  $I_{VALLEY}$ , the resistive divider values can be adjusted to define the threshold.

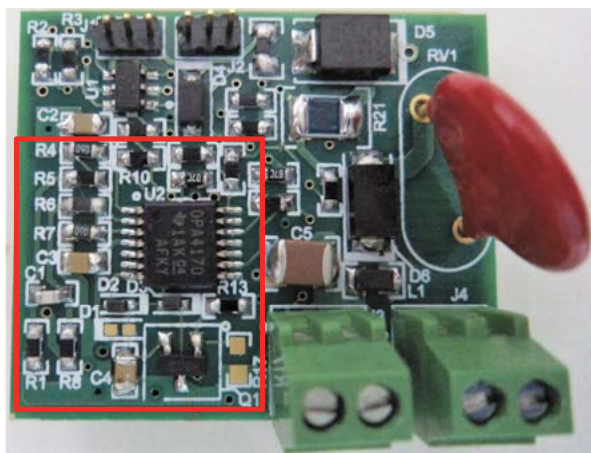

Figure 12: Solenoid driver board having plunger movement detection circuit

Figure 12 shows the image of the solenoid driver board having the plunger movement detection circuit.

Figure 13 shows the experiment test results of the plunger movement detection circuit. When the plunger has moved completely the solenoid current dips to the valley point and the comparator output  $I_{TRIP}$  latches to high.

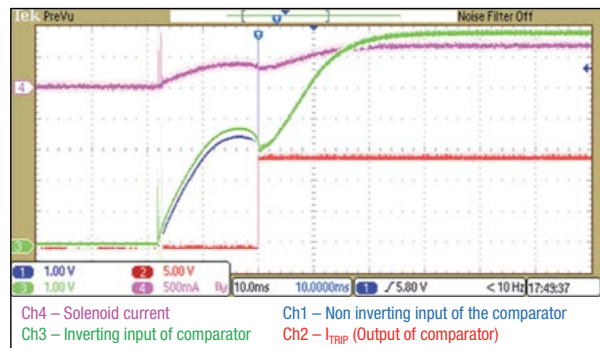

Figure 13: Experiment test results of the proposed method

The solenoid and the driver board are kept inside the thermal chamber and been tested at different temperatures. Figure 14 and Figure 15 show the results of the test done at an ambient temperature of +55°C and -30°C respectively. The fault indication output signal is high till the plunger has not moved and goes low at the end of the plunger movement. The results validates that the plunger

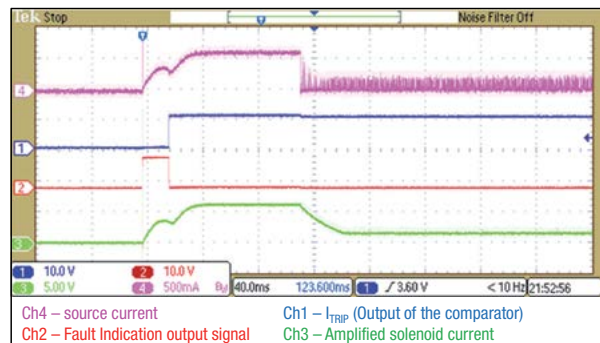

Figure 14: Experiment test results of the proposed method at +55°C



movement detection circuit is properly detecting plunger movement at different temperatures.

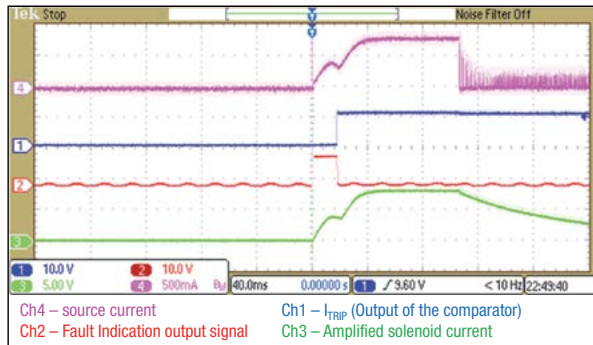

Figure 15: Experiment test results of the proposed method at  $-30^{\circ}\text{C}$

## V. Conclusion

In this paper a method is proposed to detect the proper movement of a plunger in a solenoid. The proposed method detects the movement of a plunger in a solenoid by sensing the solenoid current. The method utilizes the prominent dip in the solenoid excitation current characteristics between peak current ( $I_{\text{PEAK}}$ ) and valley current ( $I_{\text{VALLEY}}$ ), due the back EMF generated by the plunger movement. The solenoid is characterized at different temperatures and it is observed that the solenoid current dip due to back EMF remains constant irrespective of the temperature. The solution proposed in this paper utilizes this characteristic of the solenoid current in detecting the movement of the plunger of the solenoid valve. Absolute difference between  $I_{\text{PEAK}}$  and  $I_{\text{VALLEY}}$  is measured and is used to define the threshold for detection of plunger movement. The detection logic circuit senses the solenoid current

and when the current drops below the predefined threshold, it will be interpreted as the end of plunger movement. The experiment results at different temperatures validate the proposed method.

For more detailed reading, please refer to <http://www.ti.com/tool/TIDA-00289>

## VI. References

- [1] I. Dülk and T. Kovács házy, "Sensorless position estimation in solenoid actuators with load compensation," Carpathian Control Conference (ICCC), 12th International, 2011, pp. 268–273.
- [2] I. Dülk and T. Kovács házy, "Modelling of a linear proportional electromagnetic actuator and possibilities of sensorless plunger position estimation," Instrumentation and Measurement Technology Conference (I2MTC), IEEE International, 2012, pp. 89–93.
- [3] Daniel E. Zimmermann, "Electronic solenoid control apparatus and method with Hall effect technology," US Patent US5523684 A, June 4, 1996
- [4] Peter Willard Hammond, "Position sensor for mechanically latching solenoid," US Patent 8319589, Nov 27, 2012
- [5] Stephen C. O'Leyar and Robert P. Siegel, "Solenoid plunger position detection algorithm," US Patent US6326898 B1, Dec 4, 2001
- [6] Stephen Rober, "Solenoid actuator motion detection," US Patent US7432721 B2, Oct 7, 2008
- [7] Texas Instruments, "Current Controlled Driver for 24-V DC Solenoid with Plunger Fault Detection (TIDU578)," Reference Design, Nov 2014
- [8] Texas Instruments, "DRV110 – Power-saving solenoid controller with integrated supply regulation (Rev. A) (SLVSB8A)," DRV110 datasheet, Jan 2013
- [9] Texas Instruments, "Driving solenoid coils efficiently in switchgear applications (SLYT544)," *Analog Applications Journal*, Dec 2013.

Important Notice: The products and services of Texas Instruments Incorporated and its subsidiaries described herein are sold subject to TI's standard terms and conditions of sale. Customers are advised to obtain the most current and complete information about TI products and services before placing orders. TI assumes no liability for applications assistance, customer's applications or product designs, software performance, or infringement of patents. The publication of information regarding any other company's products or services does not constitute TI's approval, warranty or endorsement thereof.

All trademarks are the property of their respective owners.

## IMPORTANT NOTICE AND DISCLAIMER

TI PROVIDES TECHNICAL AND RELIABILITY DATA (INCLUDING DATASHEETS), DESIGN RESOURCES (INCLUDING REFERENCE DESIGNS), APPLICATION OR OTHER DESIGN ADVICE, WEB TOOLS, SAFETY INFORMATION, AND OTHER RESOURCES "AS IS" AND WITH ALL FAULTS, AND DISCLAIMS ALL WARRANTIES, EXPRESS AND IMPLIED, INCLUDING WITHOUT LIMITATION ANY IMPLIED WARRANTIES OF MERCHANTABILITY, FITNESS FOR A PARTICULAR PURPOSE OR NON-INFRINGEMENT OF THIRD PARTY INTELLECTUAL PROPERTY RIGHTS.

These resources are intended for skilled developers designing with TI products. You are solely responsible for (1) selecting the appropriate TI products for your application, (2) designing, validating and testing your application, and (3) ensuring your application meets applicable standards, and any other safety, security, or other requirements. These resources are subject to change without notice. TI grants you permission to use these resources only for development of an application that uses the TI products described in the resource. Other reproduction and display of these resources is prohibited. No license is granted to any other TI intellectual property right or to any third party intellectual property right. TI disclaims responsibility for, and you will fully indemnify TI and its representatives against, any claims, damages, costs, losses, and liabilities arising out of your use of these resources.

TI's products are provided subject to TI's Terms of Sale (<https://www.ti.com/legal/termsofsale.html>) or other applicable terms available either on [ti.com](https://www.ti.com) or provided in conjunction with such TI products. TI's provision of these resources does not expand or otherwise alter TI's applicable warranties or warranty disclaimers for TI products.

Mailing Address: Texas Instruments, Post Office Box 655303, Dallas, Texas 75265  
Copyright © 2021, Texas Instruments Incorporated