

DesignDRIVE Development Kit IDDK v2.2

User's Guide



Literature Number: SPRUI24
July 2015

Introduction

The DesignDRIVE is a hardware and software platform that facilitates developing and evaluating solutions for many industrial drive and servo topologies. The DesignDRIVE kit and software offer an easy path to begin exploring a wide variety of motor types, sensing technologies, encoder standards, and communications networks. The DesignDRIVE kit and software also offer easy expansion to develop with real-time Ethernet communications and functional safety topologies that enable more comprehensive and integrated system solutions.

With the C2000™ DesignDRIVE Software and Kit (IDDK), TI wants to help you spend more time differentiating your product in your core areas and less time evaluating new technologies that will eventually become table stakes in the industry. Using DesignDRIVE can help you deliver a more valuable product to market faster.

Based on the real-time control architecture of TI's C2000 microcontrollers, DesignDRIVE is ideal for the development of industrial inverter and servo drives used in robotics, computer numerical control (CNC) machinery, elevators, materials conveyance, and other industrial manufacturing applications.

This guide explains the steps required to run the motor with the IDDK using the software supplied through controlSUITE™. controlSUITE is a suite of example projects using TI's C2000 devices. This suite contains technical literature that includes software to verify the control systems as given by the names of various projects. The projects in controlSUITE are open source code from TI supporting C2000 devices and can be downloaded from <http://www.ti.com/tool/controlsuite>.

The following projects are currently available for IDDK based on TMS320F28377x MCU:

- IDDK_PM_Servo_F2837x: Sensored Field Oriented Control of Permanent Magnet Motor

The features of this project include the following:

- Position, Speed, and Torque Control Loops
- On-chip Position Sensor Support: Resolver and Incremental Encoder (QEP)
- Simultaneous Current Sensing Support for: Fluxgate/Hall, Delta-Sigma, and Shunt

NOTE: Read this guide and the *DesignDRIVE Development Kit IDDK v2.2 Hardware Reference Guide* ([SPRUI23](#)) before using the kit.

Ensure you understand the safety measures required to use the kit.

When controlSUITE is installed, you can find the Hardware Reference Guide at:
`controlSUITE\development_kits\TMDSIDDK_v1.0\~Docs\`

The software is at:
`controlSUITE\development_kits\TMDSIDDK_v1.0\IDDK_PM_Servo_F2837x`

WARNING

TI intends this EVM to be operated in a lab environment only and does not consider it to be a finished product for general consumer use.

TI intends this EVM to be used only by qualified engineers and technicians familiar with risks associated with handling high-voltage electrical and mechanical components, systems, and subsystems.

This equipment operates at voltages and currents that can cause shock, fire, and/or injure you if not properly handled or applied. Use the equipment with necessary caution and appropriate safeguards to avoid injuring yourself or damaging property.

TI considers it the user's responsibility to confirm that the voltages and isolation requirements are identified and understood before energizing the board and or simulation. When energized, do not touch the EVM or components connected to the EVM.

The Hardware Configuration

To experiment with IDDK for digital motor control, you will need following components:

- An IDDK EVM
- A TMDXCNC28377D control processor
- A USB-B to A cable
- A PMSM motor for evaluation
 - The motor is not included with the TMDXIDDK377D.
 - The motor is included with the TMDXIDDK377D-MTR-BNDL bundle.
 - The motor is available standalone from TI eStore. (The part number is HVPMSMMTR.)
- An incremental encoder or resolver (QEP included with motor available on the TI eStore)
- An external, isolated, 15-V power supply for MCU code development (TI recommends a power supply with a barrel connector [a DC-jack])
- An isolated high-voltage DC-power supply
- A PC with Code Composer Studio™ (version 6 or greater) installed
- Additional instruments such as:
 - An oscilloscope
 - A digital multimeter
 - A current sensing probe
 - A function generator

The experimental setup and connection are illustrated in the following sections. For details about the kit hardware, see the *DesignDRIVE Development Kit IDDK v2.2 Hardware Reference Guide* ([SPRUI23](#)).

For the schematic details of the IDDK EVM, see the schematic at `controlSUITE\development_kits\TMDSIDDK_v1.0\IDDK_HwDevPkg\IDDK_HwDevPkg_v2.2`.

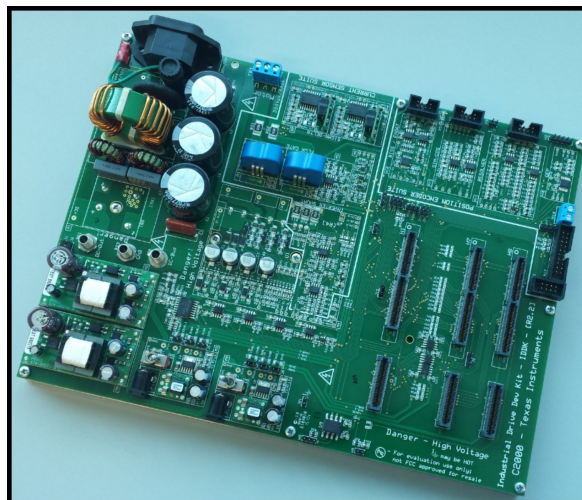

Figure 2-1. DesignDRIVE Kit (IDDK)

2.1 The Hardware Layout of IDDK

Figure 2-2 shows the IDDK that TI designed by integrating various function specific macro blocks.

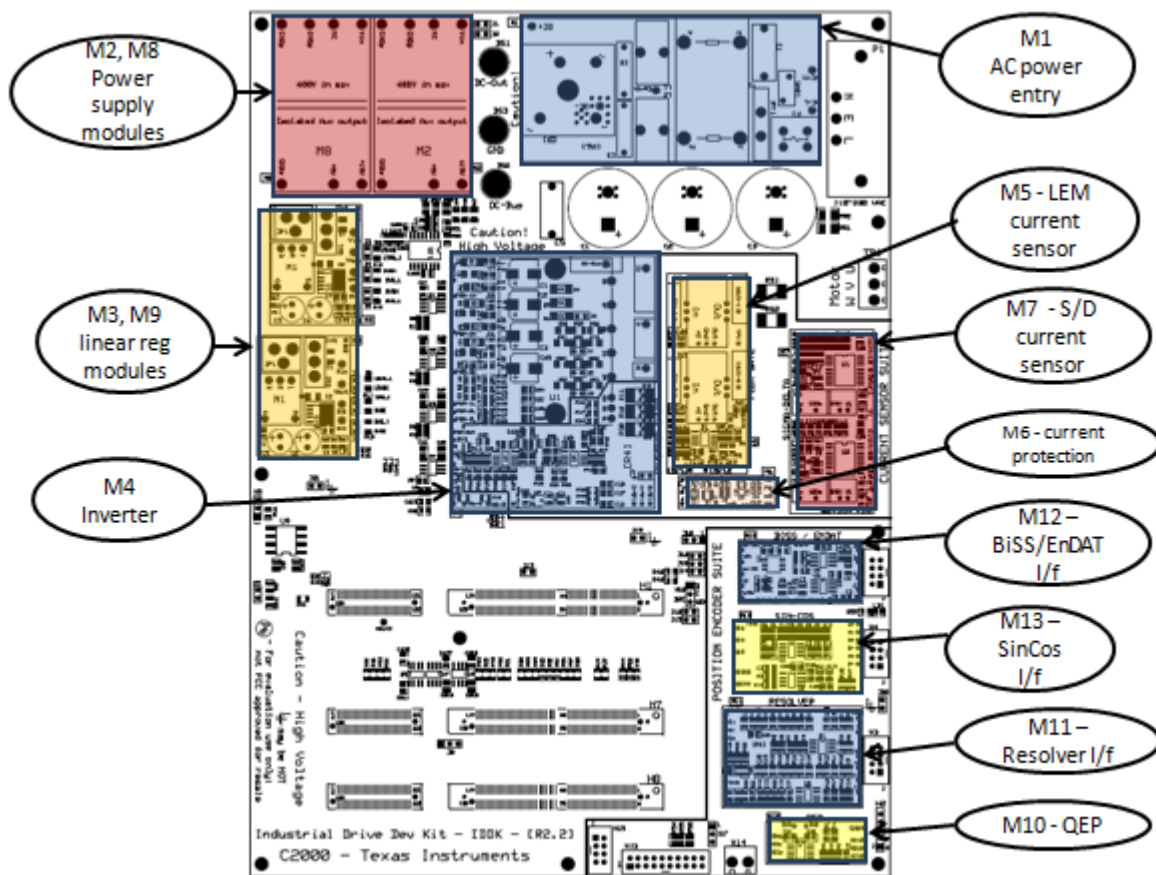

Figure 2-2. Layout of IDDK EVM With Functional Macros

The following list provides a description of each block:

- [Main] – Processor slots, jumpers, interprocessor communications, and digital-to-analog converters (DACs) and sections not covered by other macros
- [M1] – AC-power entry rectifies AC power from the wall/mains power supply. The output of this block can then be the DC bus for the inverter.
- [M2] – Auxiliary power supply–1: a 400-V to 5-V and 15-V module that can generate 15-V and 5-V for the inverter section of the board from rectified AC power. Through the proper jumper settings, this output of this block can provide 15 V to the entire board.
- [M8] – Auxiliary power supply–2: a 400-V to 5-V and 15-V module that can generate 15-V and 5-V for the control section of the board from rectified AC power. Through the proper jumper settings, this block can provide 15 V to the entire board.
- [M3] – DC-power entry 1 generates 15 V, 5 V, and 3.3 V for the HV section of the board from DC power fed through the DC-jack using an external or [M2] power supply. Through the proper jumper settings, this block can power the entire board.
- [M9] – DC-power entry 2 generates 15 V, 5 V, and 3.3 V for the control section of the board from DC power fed through the DC-jack using an external or [M8] power supply. Through the proper jumper settings, this block can power the entire board.
- [M4] – A 3-phase inverter that enables control of high voltage 3-phase motors
- [M5] – A flux gate current sensor module that provides isolated voltage feedback of motor phase currents V and W

- [M6] – An overcurrent protection module that generates a TRIP signal to shutdown the inverter in the event of overcurrent through the motor
- [M7] – A sigma-delta interface module that provides motor phase current feedback to the CPU for digital control of motor
- [M10] – An interface module that translates 5-V logic signals from an incremental encoder into 3.3 V for the C2000 and its QEP peripheral
- [M11] – An analog interface module to work with the Resolver position sensor
- [M12] – A digital interface module to work with a BISS or EnDAT position encoder
- [M13] – An analog interface module to work with the Sin/Cos position encoder

Each component is referenced with their macro number in the brackets followed by a dash and the reference number.

The following is an example of this reference format:

- [M3] - J1 refers to jumper J1 in the macro M3.
- [Main] - J1 refers to jumper J1 on the board but outside of the macro blocks defined previously.

2.2 The IDDK Power Supplies

The IDDK has a low-voltage domain represented by the controller and a high-voltage domain represented by the rectifier and the inverter

2.2.1 The Low-Voltage Power Domain

This domain represents the 15 V, 5 V, and 3.3 V to power the MCU, logic, sensing, and driver circuits on the IDDK.

The power input for this domain can be provided using the following methods:

- Connecting an isolated 15-V DC-power supply to the DC-jack ([M3]-JP1/[M9]-JP1) on the DC-power entry macro.
- Using an auxiliary power supply module ([M2]/M[8]) on the board that can generate 15 V and 5 V DC from the high-voltage DC link.

NOTE: Because the input voltage range of this module is from 90 V to 400 V, the auxiliary modules are unsuitable if the DC-bus voltage goes below 90 V during the tests. In such cases, TI recommends using the first method.

- Configuring [M3] and [M9], which are identical macros that provide the same set of output voltages, to power the entire controller or the gate drives of the inverter. (See the *DesignDRIVE Development Kit IDDK v2.2 Hardware Reference Guide* [[SPRU123](#)].)

Default configuration of the kit:

- Set up [M9] as the low-voltage power source.
- Connect both control GND and power GND planes.

For applications requiring a COLD control GND:

- Do not use the shunt current sensing method. (See Section 3.7, *Power Supplies and GND Plane Configurations* in *DesignDRIVE Development Kit IDDK v2.2 Hardware Reference Guide* [[SPRU123](#)] for details.)

NOTE: The control GND and power GND can be separate or tied together. If control GND and power GND are tied together, the control GND is HOT. If they are not tied together, the control GND is COLD. (See the *DesignDRIVE Development Kit IDDK v2.2 Hardware Reference Guide* [[SPRU123](#)].)

For your safety and convenience during general code development, testing, and verification, use an external isolated 15-V power supply to power the control section of the board through DC-power entry macro [M9] (or [M3]).

2.2.2 The High-Voltage Power Domain

This domain represents the DC-link section powering the inverter that generates three-phase voltages for the motor.

The following are ways to provide this voltage to the inverter:

- Connect an external isolated variable DC-power supply (maximum 350 V) using banana jacks to [Main]-BS2 and [Main]-BS3 of IDDK. TI recommends using this power supply during experiments. To power the auxiliary power supply modules [M2]/[M8], connect [Main]-BS3 and [Main]-BS1.
- Connect the kit to AC Mains through P1 (110 V or 220 V AC). An onboard rectifier converts AC to DC. For your safety, TI recommends using a variable AC transformer (variac) and isolator when using this power source.

NOTE: Keep power supplies at zero unless directed to energize.

The 3-phase induction motors are typically rated at 220-V AC. You need a 320-V DC-bus voltage. When using 110-V AC-power source to generate the DC bus for the inverter (150 V), the motor can run properly to a certain speed and torque range without saturating the PID regulators in the control loop. You can connect directly to a DC-power supply.

WARNING

The ground planes of both the power domains can be same or different depending on hardware configuration.

Meet proper isolation requirements before connecting any test equipment with the board to ensure the safety of yourself and your equipment.

Review the GND connections in the *DesignDRIVE Development Kit IDDK v2.2 Hardware Reference Guide* ([SPRUI23](#)) before powering the board.

Setting Up the Test Hardware

As the default configuration, the experiment uses one common HOT GND that connects the control and power circuits. (See entry 4 of Table 3-2, *Power Supply Connection Configuration* in the *DesignDRIVE Development Kit IDDK v2.2 Hardware Reference Guide* [SPRUI23].)

For setting up the experimental hardware, perform the following steps:

1. Ensure that jumpers [Main]-J6, [Main]-J7, and [Main]-J8 in front of macro M9, are populated.
2. Ensure that resistors [Main] R8 through R13 are populated.
3. Ensure that GND plane resistors R14 and R15 are mounted. (See Figure 3-12, *Various GND Planes on the Bottom Side of Board* and Figure 3-13, *Default Connection of Various GND Planes of DesignDRIVE Development Kit IDDK v2.2 Hardware Reference Guide* [SPRUI23].)
4. Unpack the TMDXCNC28377D control card.
5. Slide the card into the connector slot of [Main]-H1. (Push down using even pressure on both ends of the card until it cannot slide further. To remove the card, spread open the retaining clips and pull the card out, applying even force at the edges.)
6. Connect a USB cable to connector J1 on the control card. (The control card isolates the JTAG signals between the C2000 device and the computer. LED D2 on the control card should light.)
7. Ensure that toggle switch [M9]-SW1 is in the Int position.
8. Connect an isolated 15-V DC-power supply to [M9]-JP1.
9. Turn on toggle switch [M9]-SW1. ([M9]-LD1 should turn on.

NOTE: More LEDs on the control card light up. These LEDs indicate that the control card is receiving power from the board.

Connect the motor to the [Main]-TB1 terminals only after finishing the first incremental build.

10. Apply the DC-bus power only when the guide instructs by. Two options exist to get DC-bus power:
 - To use an external, variable DC-power supply, do the following:
 - (a) Set the power-supply output to zero.
 - (b) Connect [Main]-BS2 and [Main]-BS3 to the + and – terminals of the DC-power supply, respectively. (See Figure 3-1.)
 - To use AC-Mains power, do the following:
 - (a) Connect [Main]-BS1 to [Main]-BS2 using a banana plug cord.
 - (b) Connect the end of the AC-power cord to [Main]-P1.
 - (c) Set the output of the variac to zero.
 - (d) Connect the variac to the wall supply through an isolator. (See Figure 3-2.)
 - (e) Connect the other end of the AC-power cord to the output of the variac.

WARNING

DC-bus capacitors remain charged long after the mains supply is disconnected. Use caution.

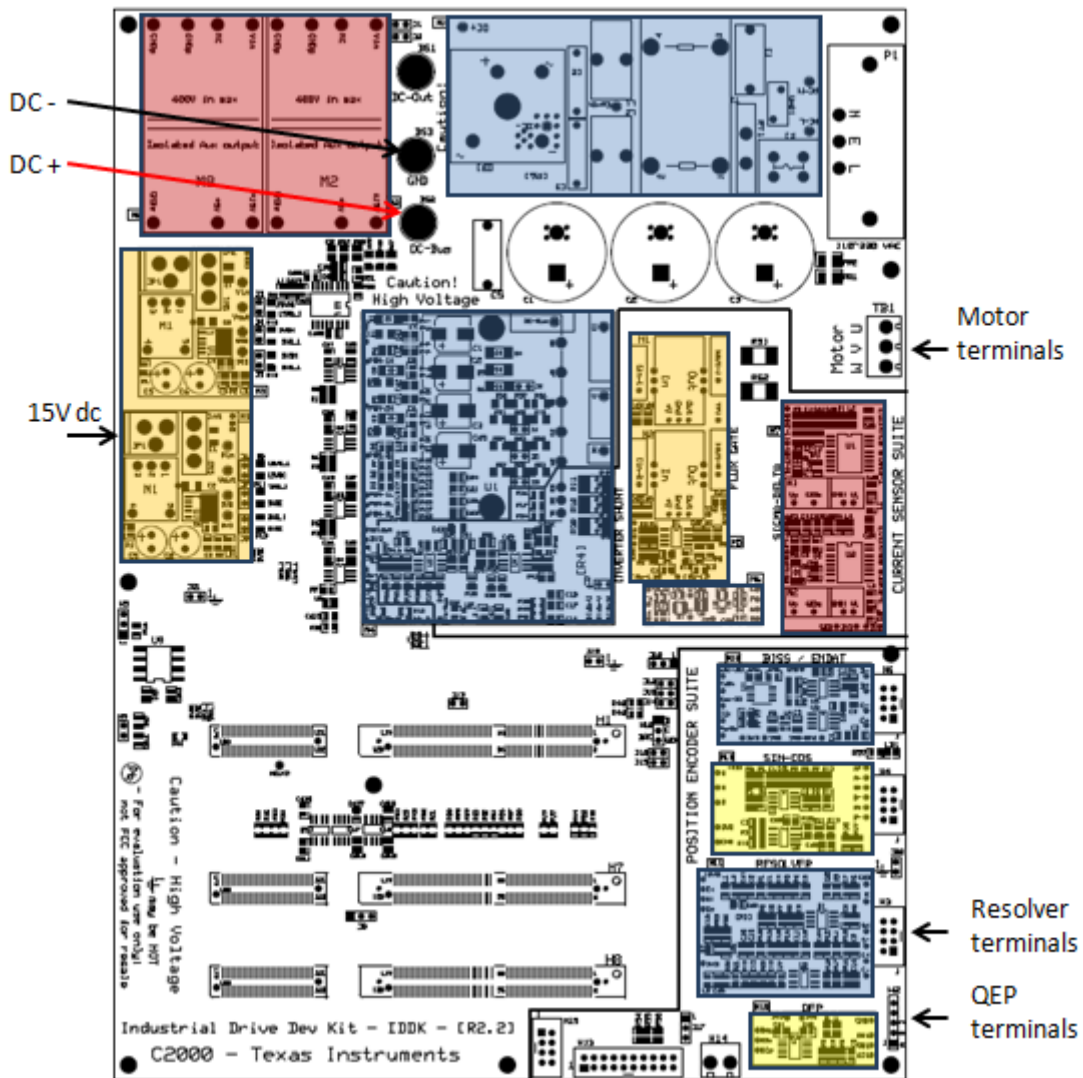

Figure 3-1. Connection Diagram With External Variable DC-Power Supply Providing DC-Bus Voltage

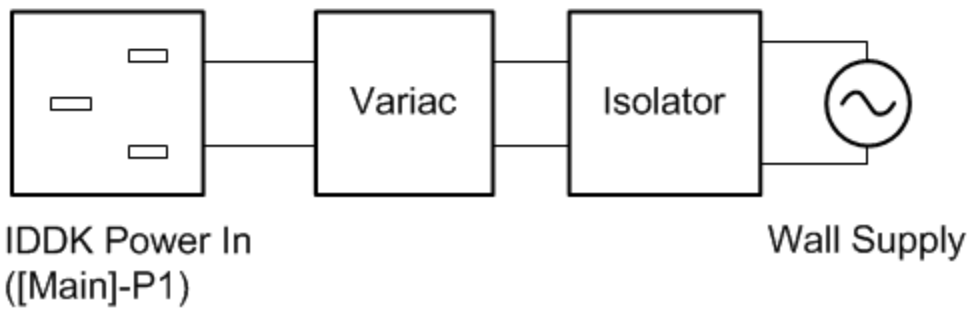
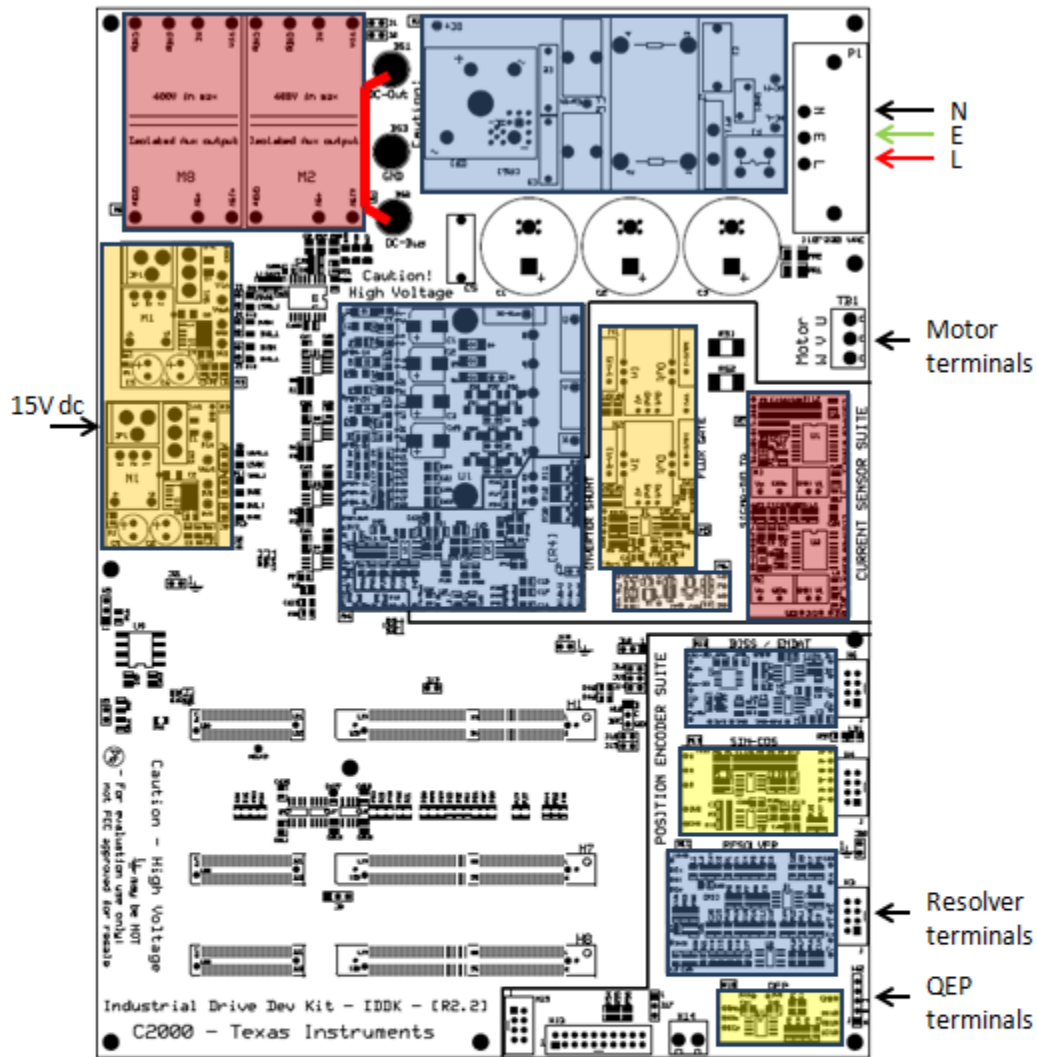

Figure 3-2. Connection Diagram With AC Input

Setting Up the Software for IDDK Projects

4.1 Installing Code Composer and controlSUITE

1. If not already installed, install Code Composer v6.x or later from <http://www.ti.com/tool/CCSTUDIO>
2. Go to <http://www.ti.com/controlsuite>
3. Run the controlSUITE installer.

NOTE: Allow the installer to download and update any automatically-checked software for C2000.

4.2 Setting Up Code Composer Studio to Work With TMDXIDDK377D

1. Open Code Composer Studio (Version 6 or later).

NOTE: When Code Composer Studio opens, the workspace launcher may appear that requests the selection of a workspace location on the hard drive where all the settings for the IDE, that is, which projects are open, what configuration is selected, and so forth, are saved. This can be anywhere on the disk. The location mentioned in the following steps is for reference. If this is not your first time to run Code Composer, the dialog in the following steps may not appear).

2. Click *Browse*.
3. Create the following path: *C:\c2000 projects\CCSv6_workspaces\IDDK_workspace*
4. Uncheck the box labeled *Use this as the default and do not ask again*.
5. Click *OK*.

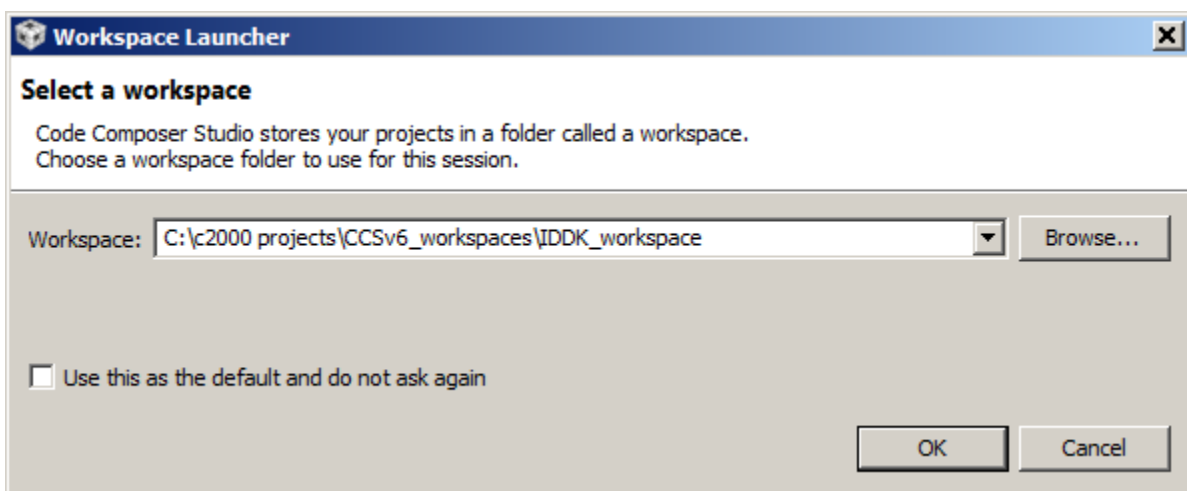



Figure 4-1. Workspace Launcher

NOTE: A *Getting Started* tab opens with links to tasks for creating a new project, importing an existing project, and watching a tutorial on CCS.

NOTE: You must set up the *Target Configuration* to configure Code Composer Studio to recognize the MCU to which it must connect. The target configurations are already set up in xds100v2_F2837x.ccxml in the project files.

6. If you intend to use the configuration file included in the project files, skip to step 28. To create your own configuration file, proceed to the next step.
7. Click *View* to set a new configuration file.
8. Click *Target Configuration* to open the *Target Configuration* window.
9. Click  in the *Target Configuration* window.
10. Name the new configuration file based on the target device.

NOTE: If *Use shared location* is checked, store this configuration file in a common location by CCS for use by other projects.

11. Click *Finish*.

NOTE: A new tab opens. (See [Figure 4-2](#).)

12. Select the connection.
13. Enter the connection. (Use the TI XDS100v2 USB Emulator or the TI XDS100v2 USB Debug Probe.)
14. Select the device.
15. Enter the device (for example, the C2000 MCU on the control card or TMS320F28377D).
16. Click *Save* and close.

Basic

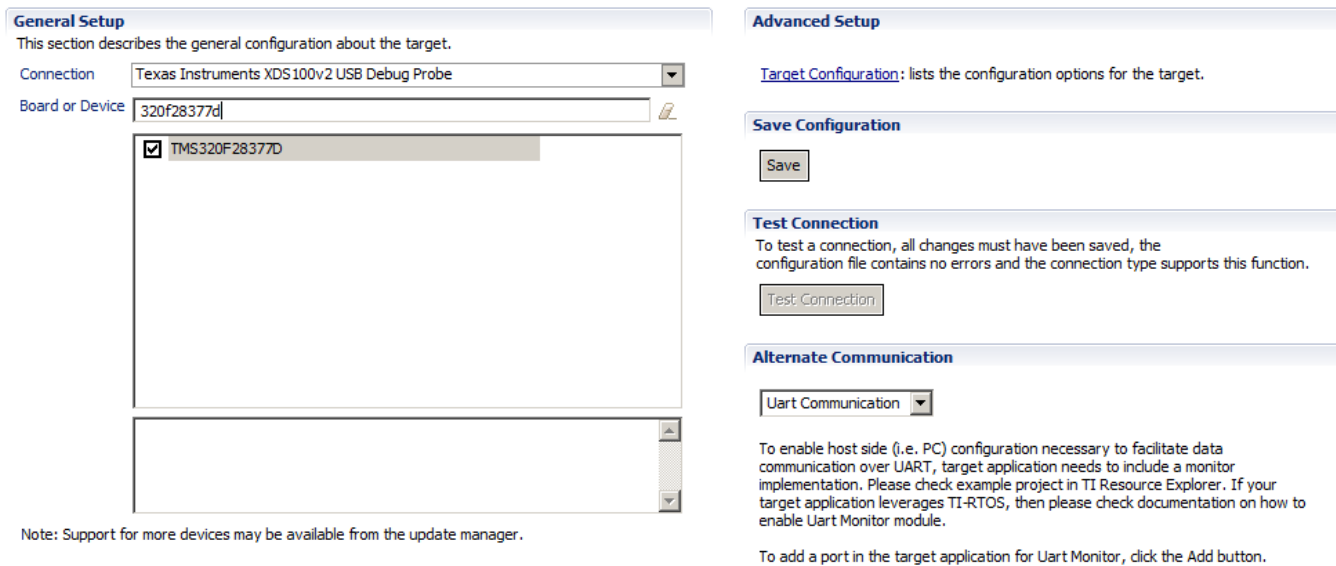

Figure 4-2. Configuring a New Target

17. Click *View*.
18. Click *Target Configurations*.
19. Find the file that you created in steps 7 to 16 in the *User Defined* section.
20. Right-click this file.
21. Select *Set as Default*.

NOTE: Alternatively, to use the *Target Configuration* file in the controlSUITE project at any time, proceed to step 22 or skip to step 28.

22. Click *View*.
23. Click *Target Configurations*.
24. Click *Expand Projects*.
25. Select *IDDK_PM_Servo_F2837x*.
26. Right-click *xds100v2_F2837x.ccxml*.
27. Click *Set as Default*. (This tab also lets you to reuse existing target configurations and link them to specific projects. This step completes the target configuration setup.)
28. To add the motor control projects into the current workspace, click *Project*.
29. Click *Import CCS Project*.
30. To select the IDDK project, navigate to: `C:\TI\controlSUITE\development_kits\TMDSIDDK_v1.0\IDDK_PM_Servo_F2837x`. (See [Figure 4-3](#).)

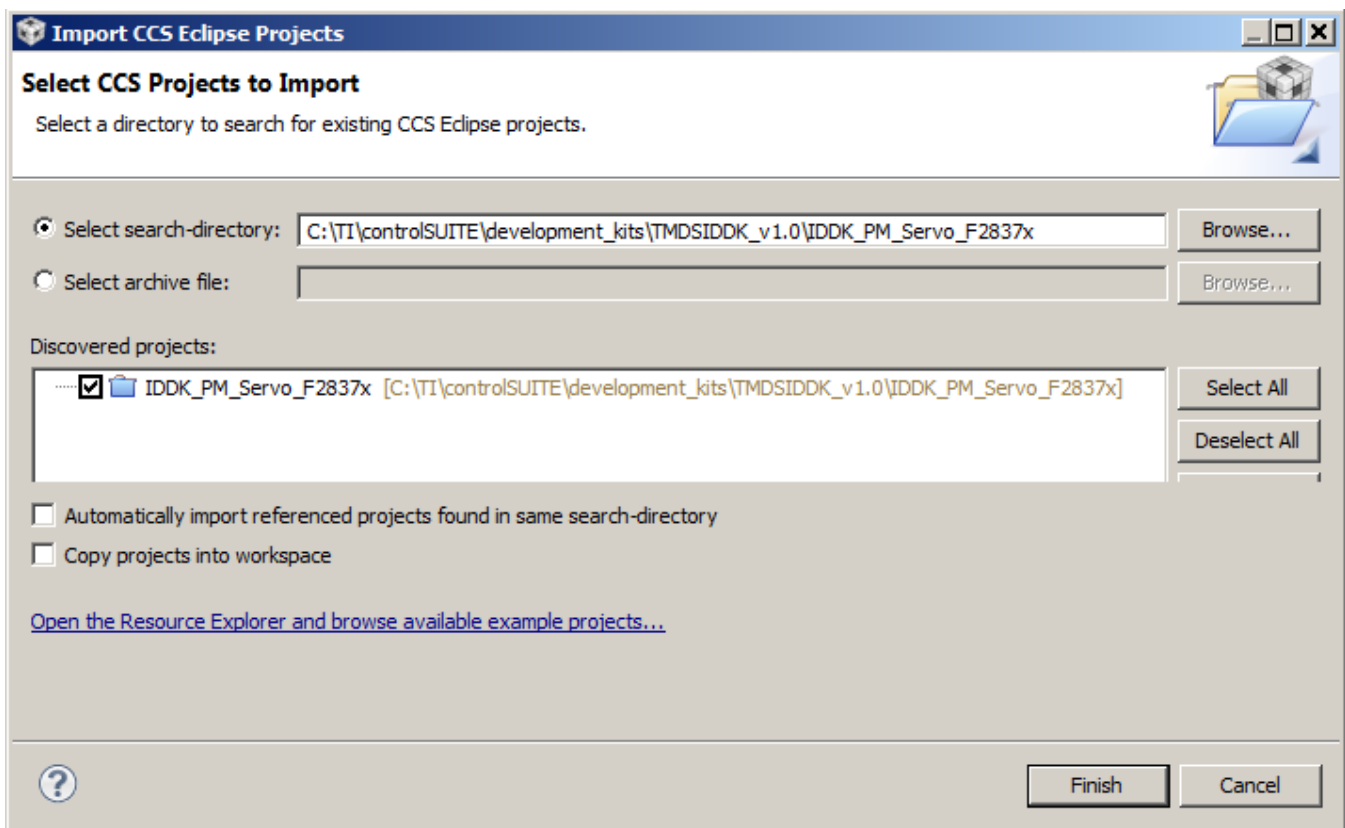

Figure 4-3. Adding an IDDK Project to Workspace

- If there are multiple projects in this directory, do the following:
- (a) Click the projects to import. ([Figure 4-3](#) shows one project in the directory.)
 - (b) Click *Finish*. (This copies all the selected projects into the workspace.)

4.3 Configuring a Project

NOTE: If this is your first time using Code Composer, xds100v2-F2837x must be the default target configuration.

1. To verify if xds100v2-f2837x.ccxml is the default configuration file, view this file in the expanded project structure and check to see if [Active/Debug] status is marked next to it.
2. Click *Target Configurations* to edit existing target configurations or change the default or active configuration.
3. Right-click the name of the target configuration to link a target configuration to a project in the workspace.
4. Select *Link to Project*.

NOTE: The project can be configured to create code and run in either flash or RAM. For lab experiments, use the RAM configuration most of the time and use the flash configuration for production.

5. Right-click the project you wish to work with if there are multiple projects in the workspace.
6. Click *View*.
7. Select *Active Build Configuration*.
8. Click the *F2837x_RAM* configuration. (See [Figure 4-4](#).)

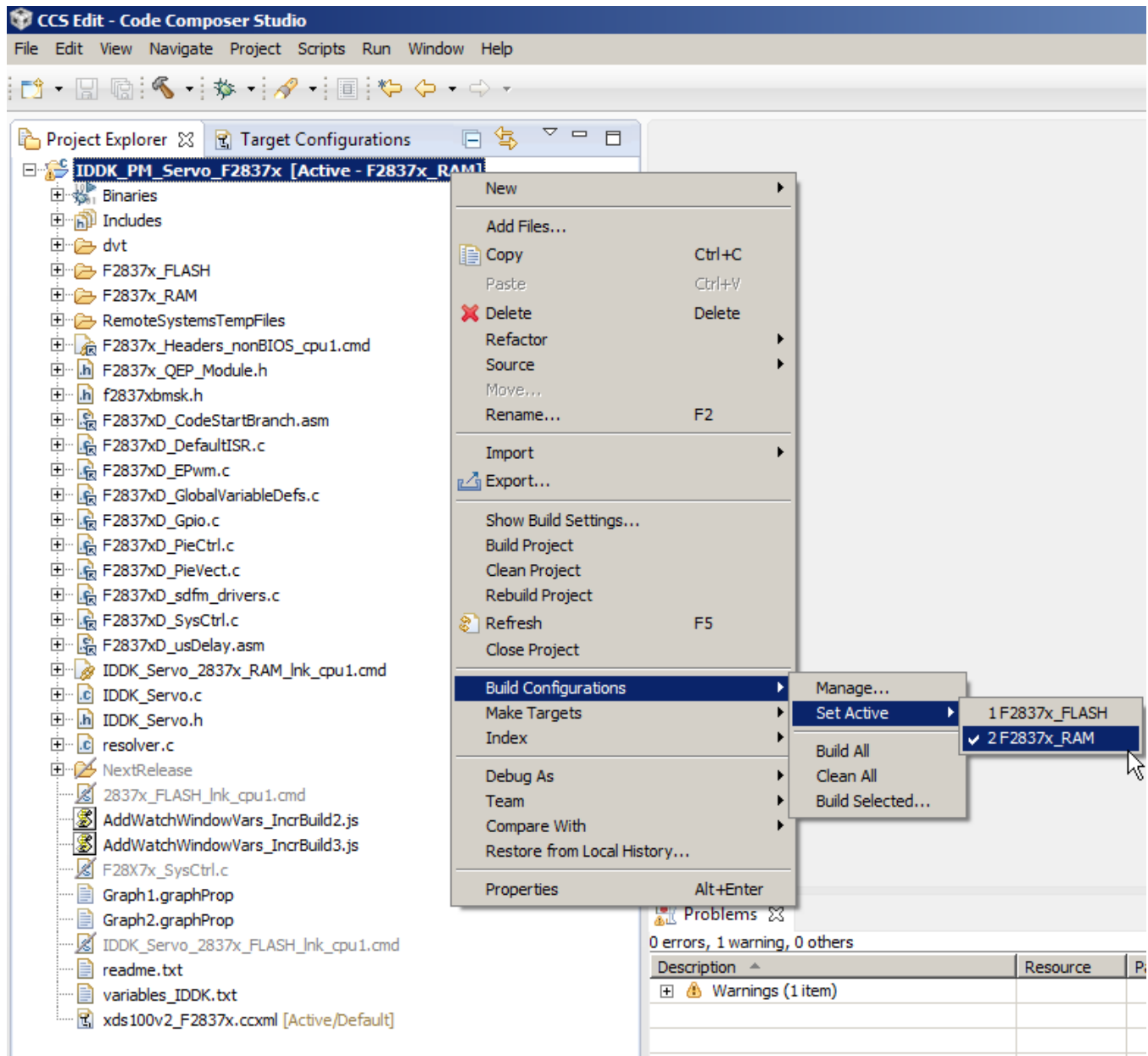

Figure 4-4. Selecting the F2837x_RAM Configuration

4.4 Building and Loading the Project

The TI motor control software has incremental builds where different components and macro blocks of the system are pieced together, one-by-one, to form the entire system. (This build structure helps to easily debug and understand the system.)

1. Open the file [Project-Name]-Settings.h from the CCS Edit Perspective.
2. Set the BUILDLEVEL to LEVEL1.
3. Save this file.

NOTE: After testing build 1, redefine BUILDLEVEL to LEVEL2 for the next level tests. Increment the BUILDLEVEL and perform the tests for each level until all builds are complete.

4. Open the [Project-Name].c file.
5. Navigate to the *MainISR()* function.
6. Locate the following piece of code in incremental build 1.

```
DlogCh1=rg1.Out;
DlogCh2=svgen1.Ta;
DlogCh3=svgen1.Tb;
DlogCh4=svgen1.Tc;
```

7. Confirm that the datalog buffers point to the correct variables.

NOTE: These datalog buffers are large arrays that contain value-triggered data that can be displayed in a graph. In other incremental builds, variables may be put into this buffer to be graphed. The previous code is an example where the datalog buffers are pointed to the space vector generator module.

8. Right-click on the project name.
9. Click *Rebuild Project*.
10. Ensure the console window is error free.
11. When the build completes, click  (Debug).

NOTE: A window as shown in [Figure 4-5](#) may pop up if this is the first time opening the debug window. The window requests that you select one of the two CPUs in F28377x with which to connect.

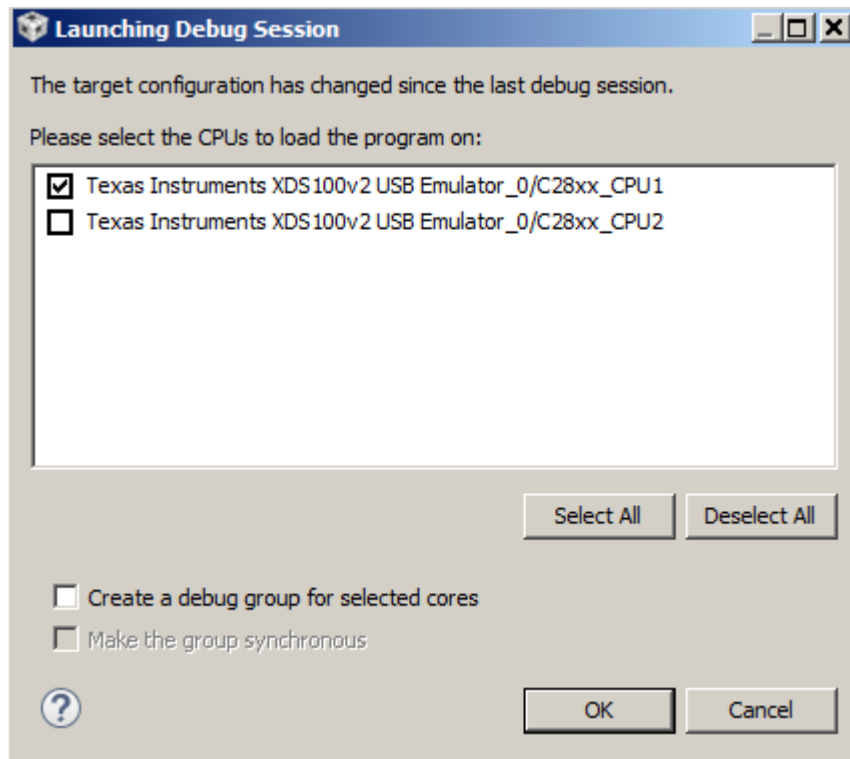



Figure 4-5. Selecting the CPU to Connect

12. Click the box next to CPU1.

NOTE: The IDE automatically connects to the target.

13. Load the output file into the device.
14. Change to the debug perspective.
15. Click *Tools*.
16. Click *Debugger Options*.
17. Click *Program*.
18. Click *Memory Load Options*.
19. Check *Reset the target when loading or restarting the program* to enable the debugger to reset the processor each time it reloads the program,.
20. Click *Remember My Settings* to make this setting permanent,.
21. Click  (Enable silicon real-time mode).

NOTE: Clicking this mode automatically selects  (Enable polite real-time mode). This action lets you edit and view variables in real-time. Do not reset the CPU unless you disable these real-time options.

22. If a message box appears, select yes to enable the debug events.

NOTE: This action sets bit 1 (the DGBM bit) of status register 1 (ST1) to 0. The DGBM is the debug enable mask bit. When the DGBM bit is set to 0, memory and register values can pass to the host processor to update the debugger windows.

4.5 Setting Up the Watch Window and Graphs

1. Click *View*.
2. To open a watch window to view the variables used in the project, click *Expressions* on the menu bar.
3. Add variables to the watch window. (See [Figure 4-6](#).)

To select a number format for the variable, do the following:

- (a) Right-click the variable.
- (b) Choose the format. (See [Figure 4-6](#).)

NOTE: The watch window uses the same number format with which the variable is declared.

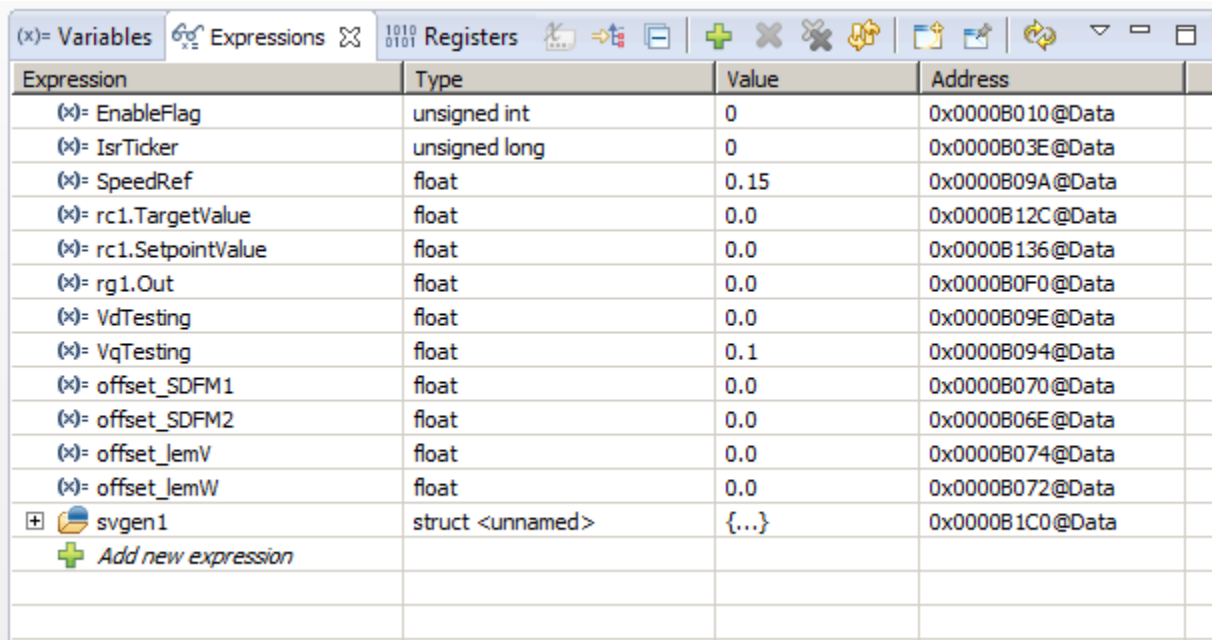

Expression	Type	Value	Address
(x)= EnableFlag	unsigned int	0	0x0000B010@Data
(x)= IsrTicker	unsigned long	0	0x0000B03E@Data
(x)= SpeedRef	float	0.15	0x0000B09A@Data
(x)= rc1.TargetValue	float	0.0	0x0000B12C@Data
(x)= rc1.SetpointValue	float	0.0	0x0000B136@Data
(x)= rg1.Out	float	0.0	0x0000B0F0@Data
(x)= VdTesting	float	0.0	0x0000B09E@Data
(x)= VqTesting	float	0.1	0x0000B094@Data
(x)= offset_SDFM1	float	0.0	0x0000B070@Data
(x)= offset_SDFM2	float	0.0	0x0000B06E@Data
(x)= offset_JemV	float	0.0	0x0000B074@Data
(x)= offset_JemW	float	0.0	0x0000B072@Data
+ svgen1	struct <unnamed>	{...}	0x0000B1C0@Data
+ Add new expression			

Figure 4-6. Configuring the Expressions Window

Alternately, you can import a group of variables into the Expressions window by doing the following:

- (a) Right-click in the Expressions window.
 - (b) Click *Import*.
 - (c) Navigate to the .txt file containing these variables.
 - (d) Navigate to the root directory of the project.
 - (e) Pick Variables_IDDK_Level1.txt.
 - (f) Click *OK* to import the variables. (See [Figure 4-6.](#))
4. Click  (Continuous Refresh) in the watch window.

NOTE: This action enables the window to run with real-time mode. If you click the down arrow in this watch window, you can select *Customize Continuous Refresh Interval* and edit the refresh rate of the watch window. Choosing an interval that is too fast can affect performance.

The datalog buffers point to different system variables depending on the build level. The buffers let you inspect the variables and judge the performance of the system. [Figure 4-7](#) shows open and setup time graph windows to plot the data log buffers.

Alternatively, you can import graph configurations files in the project folder by doing the following:

- (a) Click *Tools*.
- (b) Click *Graph*.
- (c) Click *DualTime...*
- (d) Click *Import*.
- (e) Navigate to *C:\TI\ControlSUITE\development_kits\TMDSIDDK_v1.0\IDDK_PM_Servo_F2837x*.
- (f) Select *Graph1.graphProp*. (The Graph Properties window should look like [Figure 4-7.](#))
- (g) Click *OK* to add graphs to your debug perspective.
- (h) Click  (Continuous Refresh).

NOTE: If using a second graph window, import *Graph2.prop* (the beginning address for this should be *DBUFF_4CH3* and *DBUFF_4CH4*).

The default *dlog.prescaler* is set to 5, which lets the *dlog* function to only log one out of every five samples.

Set the default *dlog.trig_value* to the correct value to generate trigger for the plot similar to using an oscilloscope within a debug environment.

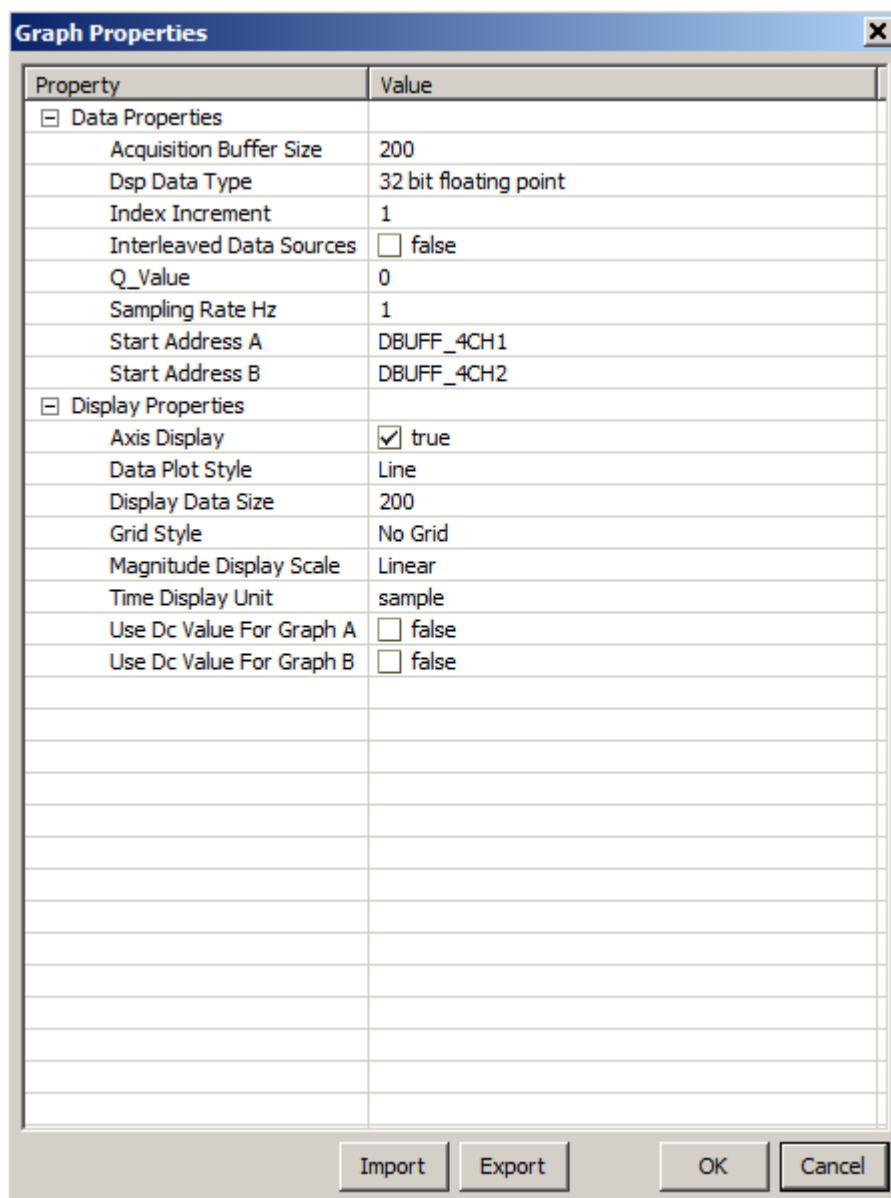





Figure 4-7. Graph Window Settings

4.6 Running the Code

1. Click *Run* in the Debug tab.
2. In the *Expressions* window, set the EnableFlag to 1.

NOTE: The project runs and the values in the graphs and watch window continuously update. The following screen captures are typical CCS perspectives while using this project. You may resize the windows.

3. When complete, click  (Run).
4. Click *Reset*.
5. Click  (CPU Reset) to reset the processor.
6. Click *Run*.
7. Click  (Terminate) to terminate the debug session.

NOTE: This halts the program and disconnects Code Composer from the MCU.

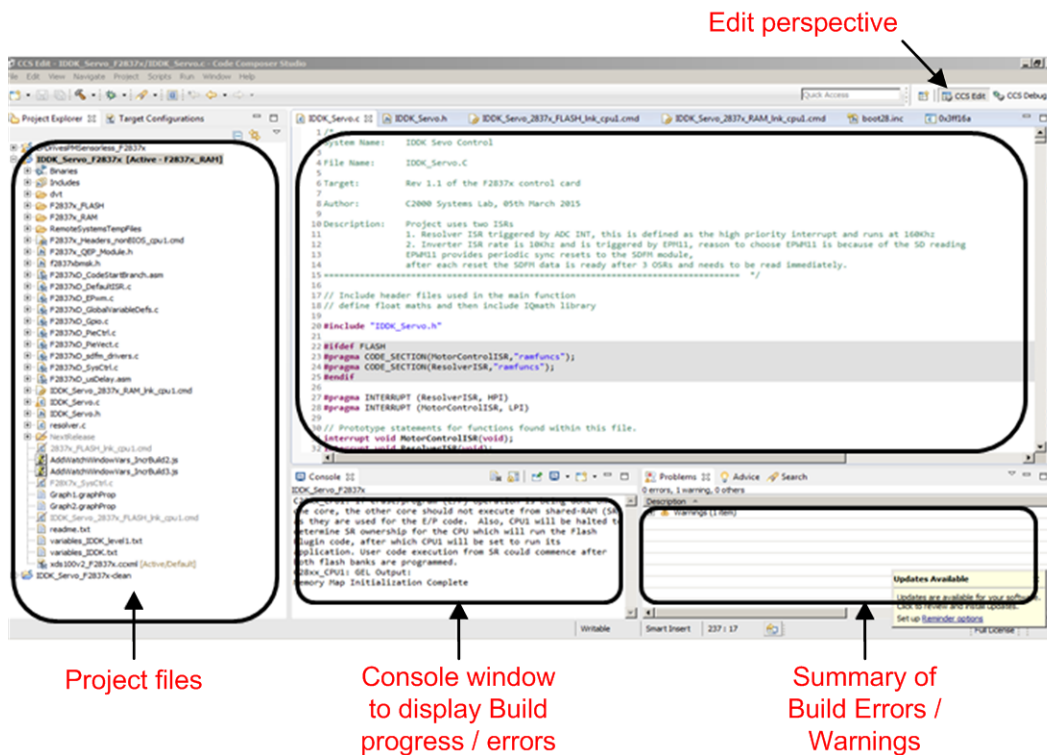



Figure 4-8. CCS IDE Showing Edit Perspective

Terminating the debug session each time you change or run the code is unnecessary. Instead of terminating, do the following after rebuilding the project:

1. Click *Run*.
2. Click *Reset*.
3. Click  (CPU Reset).
4. Click *Run*.
5. Click  (Restart).
6. Enable real-time options.

NOTE: After completing the tests, you can end the debug session as follows.

7. Disable real-time options.
8. Reset the CPU.
9. Terminate the project if you change the target device or the configuration from RAM to Flash or Flash to RAM and before shutting down CCS.
10. Customize the project to meet your motor and feedback sensor options.
11. Change the sensor type in *IDDK_PM_Servo_F2837x-Settings.h*.

NOTE: Feel free to change the PWM switching frequency (ISR frequency). Choose the ISR frequency as a submultiple of the PWM frequency.

12. Open the lab manual in:
controlSUITE\development_kits\TMDSIDDK_v1.0\IDDK_PM_Servo_F2837x\~Docs.
13. Start experimenting.

STANDARD TERMS AND CONDITIONS FOR EVALUATION MODULES

1. *Delivery:* TI delivers TI evaluation boards, kits, or modules, including any accompanying demonstration software, components, or documentation (collectively, an "EVM" or "EVMs") to the User ("User") in accordance with the terms and conditions set forth herein. Acceptance of the EVM is expressly subject to the following terms and conditions.
 - 1.1 EVMs are intended solely for product or software developers for use in a research and development setting to facilitate feasibility evaluation, experimentation, or scientific analysis of TI semiconductor products. EVMs have no direct function and are not finished products. EVMs shall not be directly or indirectly assembled as a part or subassembly in any finished product. For clarification, any software or software tools provided with the EVM ("Software") shall not be subject to the terms and conditions set forth herein but rather shall be subject to the applicable terms and conditions that accompany such Software
 - 1.2 EVMs are not intended for consumer or household use. EVMs may not be sold, sublicensed, leased, rented, loaned, assigned, or otherwise distributed for commercial purposes by Users, in whole or in part, or used in any finished product or production system.
2. *Limited Warranty and Related Remedies/Disclaimers:*
 - 2.1 These terms and conditions do not apply to Software. The warranty, if any, for Software is covered in the applicable Software License Agreement.
 - 2.2 TI warrants that the TI EVM will conform to TI's published specifications for ninety (90) days after the date TI delivers such EVM to User. Notwithstanding the foregoing, TI shall not be liable for any defects that are caused by neglect, misuse or mistreatment by an entity other than TI, including improper installation or testing, or for any EVMs that have been altered or modified in any way by an entity other than TI. Moreover, TI shall not be liable for any defects that result from User's design, specifications or instructions for such EVMs. Testing and other quality control techniques are used to the extent TI deems necessary or as mandated by government requirements. TI does not test all parameters of each EVM.
 - 2.3 If any EVM fails to conform to the warranty set forth above, TI's sole liability shall be at its option to repair or replace such EVM, or credit User's account for such EVM. TI's liability under this warranty shall be limited to EVMs that are returned during the warranty period to the address designated by TI and that are determined by TI not to conform to such warranty. If TI elects to repair or replace such EVM, TI shall have a reasonable time to repair such EVM or provide replacements. Repaired EVMs shall be warranted for the remainder of the original warranty period. Replaced EVMs shall be warranted for a new full ninety (90) day warranty period.
3. *Regulatory Notices:*
 - 3.1 *United States*
 - 3.1.1 *Notice applicable to EVMs not FCC-Approved:*

This kit is designed to allow product developers to evaluate electronic components, circuitry, or software associated with the kit to determine whether to incorporate such items in a finished product and software developers to write software applications for use with the end product. This kit is not a finished product and when assembled may not be resold or otherwise marketed unless all required FCC equipment authorizations are first obtained. Operation is subject to the condition that this product not cause harmful interference to licensed radio stations and that this product accept harmful interference. Unless the assembled kit is designed to operate under part 15, part 18 or part 95 of this chapter, the operator of the kit must operate under the authority of an FCC license holder or must secure an experimental authorization under part 5 of this chapter.
 - 3.1.2 *For EVMs annotated as FCC – FEDERAL COMMUNICATIONS COMMISSION Part 15 Compliant:*

CAUTION

This device complies with part 15 of the FCC Rules. Operation is subject to the following two conditions: (1) This device may not cause harmful interference, and (2) this device must accept any interference received, including interference that may cause undesired operation.

Changes or modifications not expressly approved by the party responsible for compliance could void the user's authority to operate the equipment.

FCC Interference Statement for Class A EVM devices

NOTE: This equipment has been tested and found to comply with the limits for a Class A digital device, pursuant to part 15 of the FCC Rules. These limits are designed to provide reasonable protection against harmful interference when the equipment is operated in a commercial environment. This equipment generates, uses, and can radiate radio frequency energy and, if not installed and used in accordance with the instruction manual, may cause harmful interference to radio communications. Operation of this equipment in a residential area is likely to cause harmful interference in which case the user will be required to correct the interference at his own expense.

FCC Interference Statement for Class B EVM devices

NOTE: This equipment has been tested and found to comply with the limits for a Class B digital device, pursuant to part 15 of the FCC Rules. These limits are designed to provide reasonable protection against harmful interference in a residential installation. This equipment generates, uses and can radiate radio frequency energy and, if not installed and used in accordance with the instructions, may cause harmful interference to radio communications. However, there is no guarantee that interference will not occur in a particular installation. If this equipment does cause harmful interference to radio or television reception, which can be determined by turning the equipment off and on, the user is encouraged to try to correct the interference by one or more of the following measures:

- Reorient or relocate the receiving antenna.
- Increase the separation between the equipment and receiver.
- Connect the equipment into an outlet on a circuit different from that to which the receiver is connected.
- Consult the dealer or an experienced radio/TV technician for help.

3.2 Canada

3.2.1 For EVMs issued with an Industry Canada Certificate of Conformance to RSS-210

Concerning EVMs Including Radio Transmitters:

This device complies with Industry Canada license-exempt RSS standard(s). Operation is subject to the following two conditions: (1) this device may not cause interference, and (2) this device must accept any interference, including interference that may cause undesired operation of the device.

Concernant les EVMs avec appareils radio:

Le présent appareil est conforme aux CNR d'Industrie Canada applicables aux appareils radio exempts de licence. L'exploitation est autorisée aux deux conditions suivantes: (1) l'appareil ne doit pas produire de brouillage, et (2) l'utilisateur de l'appareil doit accepter tout brouillage radioélectrique subi, même si le brouillage est susceptible d'en compromettre le fonctionnement.

Concerning EVMs Including Detachable Antennas:

Under Industry Canada regulations, this radio transmitter may only operate using an antenna of a type and maximum (or lesser) gain approved for the transmitter by Industry Canada. To reduce potential radio interference to other users, the antenna type and its gain should be so chosen that the equivalent isotropically radiated power (e.i.r.p.) is not more than that necessary for successful communication. This radio transmitter has been approved by Industry Canada to operate with the antenna types listed in the user guide with the maximum permissible gain and required antenna impedance for each antenna type indicated. Antenna types not included in this list, having a gain greater than the maximum gain indicated for that type, are strictly prohibited for use with this device.

Concernant les EVMs avec antennes détachables

Conformément à la réglementation d'Industrie Canada, le présent émetteur radio peut fonctionner avec une antenne d'un type et d'un gain maximal (ou inférieur) approuvé pour l'émetteur par Industrie Canada. Dans le but de réduire les risques de brouillage radioélectrique à l'intention des autres utilisateurs, il faut choisir le type d'antenne et son gain de sorte que la puissance isotrope rayonnée équivalente (p.i.r.e.) ne dépasse pas l'intensité nécessaire à l'établissement d'une communication satisfaisante. Le présent émetteur radio a été approuvé par Industrie Canada pour fonctionner avec les types d'antenne énumérés dans le manuel d'usage et ayant un gain admissible maximal et l'impédance requise pour chaque type d'antenne. Les types d'antenne non inclus dans cette liste, ou dont le gain est supérieur au gain maximal indiqué, sont strictement interdits pour l'exploitation de l'émetteur

3.3 Japan

3.3.1 *Notice for EVMs delivered in Japan:* Please see http://www.tij.co.jp/lstds/ti_ja/general/eStore/notice_01.page 日本国内に輸入される評価用キット、ボードについては、次のところをご覧ください。
http://www.tij.co.jp/lstds/ti_ja/general/eStore/notice_01.page

3.3.2 *Notice for Users of EVMs Considered "Radio Frequency Products" in Japan:* EVMs entering Japan may not be certified by TI as conforming to Technical Regulations of Radio Law of Japan.

If User uses EVMs in Japan, not certified to Technical Regulations of Radio Law of Japan, User is required by Radio Law of Japan to follow the instructions below with respect to EVMs:

1. Use EVMs in a shielded room or any other test facility as defined in the notification #173 issued by Ministry of Internal Affairs and Communications on March 28, 2006, based on Sub-section 1.1 of Article 6 of the Ministry's Rule for Enforcement of Radio Law of Japan,
2. Use EVMs only after User obtains the license of Test Radio Station as provided in Radio Law of Japan with respect to EVMs, or
3. Use of EVMs only after User obtains the Technical Regulations Conformity Certification as provided in Radio Law of Japan with respect to EVMs. Also, do not transfer EVMs, unless User gives the same notice above to the transferee. Please note that if User does not follow the instructions above, User will be subject to penalties of Radio Law of Japan.

【無線電波を送信する製品の開発キットをお使いになる際の注意事項】 開発キットの中には技術基準適合証明を受けていないものがあります。技術適合証明を受けていないもののご使用に際しては、電波法遵守のため、以下のいずれかの措置を取っていただく必要がありますのでご注意ください。

1. 電波法施行規則第6条第1項第1号に基づく平成18年3月28日総務省告示第173号で定められた電波暗室等の試験設備でご使用いただく。
2. 実験局の免許を取得後ご使用いただく。
3. 技術基準適合証明を取得後ご使用いただく。

なお、本製品は、上記の「ご使用にあたっての注意」を譲渡先、移転先に通知しない限り、譲渡、移転できないものとします。

上記を遵守頂けない場合は、電波法の罰則が適用される可能性があることをご留意ください。日本テキサス・インスツルメンツ株式会社
東京都新宿区西新宿 6 丁目 2 4 番 1 号
西新宿三井ビル

3.3.3 *Notice for EVMs for Power Line Communication:* Please see http://www.tij.co.jp/llds/ti_ja/general/eStore/notice_02.page
電力線搬送波通信についての開発キットをお使いになる際の注意事項については、次のところをご覧ください。http://www.tij.co.jp/llds/ti_ja/general/eStore/notice_02.page

4 *EVM Use Restrictions and Warnings:*

4.1 EVMS ARE NOT FOR USE IN FUNCTIONAL SAFETY AND/OR SAFETY CRITICAL EVALUATIONS, INCLUDING BUT NOT LIMITED TO EVALUATIONS OF LIFE SUPPORT APPLICATIONS.

4.2 User must read and apply the user guide and other available documentation provided by TI regarding the EVM prior to handling or using the EVM, including without limitation any warning or restriction notices. The notices contain important safety information related to, for example, temperatures and voltages.

4.3 *Safety-Related Warnings and Restrictions:*

4.3.1 User shall operate the EVM within TI's recommended specifications and environmental considerations stated in the user guide, other available documentation provided by TI, and any other applicable requirements and employ reasonable and customary safeguards. Exceeding the specified performance ratings and specifications (including but not limited to input and output voltage, current, power, and environmental ranges) for the EVM may cause personal injury or death, or property damage. If there are questions concerning performance ratings and specifications, User should contact a TI field representative prior to connecting interface electronics including input power and intended loads. Any loads applied outside of the specified output range may also result in unintended and/or inaccurate operation and/or possible permanent damage to the EVM and/or interface electronics. Please consult the EVM user guide prior to connecting any load to the EVM output. If there is uncertainty as to the load specification, please contact a TI field representative. During normal operation, even with the inputs and outputs kept within the specified allowable ranges, some circuit components may have elevated case temperatures. These components include but are not limited to linear regulators, switching transistors, pass transistors, current sense resistors, and heat sinks, which can be identified using the information in the associated documentation. When working with the EVM, please be aware that the EVM may become very warm.

4.3.2 EVMs are intended solely for use by technically qualified, professional electronics experts who are familiar with the dangers and application risks associated with handling electrical mechanical components, systems, and subsystems. User assumes all responsibility and liability for proper and safe handling and use of the EVM by User or its employees, affiliates, contractors or designees. User assumes all responsibility and liability to ensure that any interfaces (electronic and/or mechanical) between the EVM and any human body are designed with suitable isolation and means to safely limit accessible leakage currents to minimize the risk of electrical shock hazard. User assumes all responsibility and liability for any improper or unsafe handling or use of the EVM by User or its employees, affiliates, contractors or designees.

4.4 User assumes all responsibility and liability to determine whether the EVM is subject to any applicable international, federal, state, or local laws and regulations related to User's handling and use of the EVM and, if applicable, User assumes all responsibility and liability for compliance in all respects with such laws and regulations. User assumes all responsibility and liability for proper disposal and recycling of the EVM consistent with all applicable international, federal, state, and local requirements.

5. *Accuracy of Information:* To the extent TI provides information on the availability and function of EVMs, TI attempts to be as accurate as possible. However, TI does not warrant the accuracy of EVM descriptions, EVM availability or other information on its websites as accurate, complete, reliable, current, or error-free.

6. *Disclaimers:*

6.1 EXCEPT AS SET FORTH ABOVE, EVMS AND ANY WRITTEN DESIGN MATERIALS PROVIDED WITH THE EVM (AND THE DESIGN OF THE EVM ITSELF) ARE PROVIDED "AS IS" AND "WITH ALL FAULTS." TI DISCLAIMS ALL OTHER WARRANTIES, EXPRESS OR IMPLIED, REGARDING SUCH ITEMS, INCLUDING BUT NOT LIMITED TO ANY IMPLIED WARRANTIES OF MERCHANTABILITY OR FITNESS FOR A PARTICULAR PURPOSE OR NON-INFRINGEMENT OF ANY THIRD PARTY PATENTS, COPYRIGHTS, TRADE SECRETS OR OTHER INTELLECTUAL PROPERTY RIGHTS.

6.2 EXCEPT FOR THE LIMITED RIGHT TO USE THE EVM SET FORTH HEREIN, NOTHING IN THESE TERMS AND CONDITIONS SHALL BE CONSTRUED AS GRANTING OR CONFERRING ANY RIGHTS BY LICENSE, PATENT, OR ANY OTHER INDUSTRIAL OR INTELLECTUAL PROPERTY RIGHT OF TI, ITS SUPPLIERS/LICENSORS OR ANY OTHER THIRD PARTY, TO USE THE EVM IN ANY FINISHED END-USER OR READY-TO-USE FINAL PRODUCT, OR FOR ANY INVENTION, DISCOVERY OR IMPROVEMENT MADE, CONCEIVED OR ACQUIRED PRIOR TO OR AFTER DELIVERY OF THE EVM.

7. *USER'S INDEMNITY OBLIGATIONS AND REPRESENTATIONS.* USER WILL DEFEND, INDEMNIFY AND HOLD TI, ITS LICENSORS AND THEIR REPRESENTATIVES HARMLESS FROM AND AGAINST ANY AND ALL CLAIMS, DAMAGES, LOSSES, EXPENSES, COSTS AND LIABILITIES (COLLECTIVELY, "CLAIMS") ARISING OUT OF OR IN CONNECTION WITH ANY HANDLING OR USE OF THE EVM THAT IS NOT IN ACCORDANCE WITH THESE TERMS AND CONDITIONS. THIS OBLIGATION SHALL APPLY WHETHER CLAIMS ARISE UNDER STATUTE, REGULATION, OR THE LAW OF TORT, CONTRACT OR ANY OTHER LEGAL THEORY, AND EVEN IF THE EVM FAILS TO PERFORM AS DESCRIBED OR EXPECTED.

8. *Limitations on Damages and Liability:*

8.1 *General Limitations.* IN NO EVENT SHALL TI BE LIABLE FOR ANY SPECIAL, COLLATERAL, INDIRECT, PUNITIVE, INCIDENTAL, CONSEQUENTIAL, OR EXEMPLARY DAMAGES IN CONNECTION WITH OR ARISING OUT OF THESE TERMS AND CONDITIONS OR THE USE OF THE EVMS PROVIDED HEREUNDER, REGARDLESS OF WHETHER TI HAS BEEN ADVISED OF THE POSSIBILITY OF SUCH DAMAGES. EXCLUDED DAMAGES INCLUDE, BUT ARE NOT LIMITED TO, COST OF REMOVAL OR REINSTALLATION, ANCILLARY COSTS TO THE PROCUREMENT OF SUBSTITUTE GOODS OR SERVICES, RETESTING, OUTSIDE COMPUTER TIME, LABOR COSTS, LOSS OF GOODWILL, LOSS OF PROFITS, LOSS OF SAVINGS, LOSS OF USE, LOSS OF DATA, OR BUSINESS INTERRUPTION. NO CLAIM, SUIT OR ACTION SHALL BE BROUGHT AGAINST TI MORE THAN ONE YEAR AFTER THE RELATED CAUSE OF ACTION HAS OCCURRED.

8.2 *Specific Limitations.* IN NO EVENT SHALL TI'S AGGREGATE LIABILITY FROM ANY WARRANTY OR OTHER OBLIGATION ARISING OUT OF OR IN CONNECTION WITH THESE TERMS AND CONDITIONS, OR ANY USE OF ANY TI EVM PROVIDED HEREUNDER, EXCEED THE TOTAL AMOUNT PAID TO TI FOR THE PARTICULAR UNITS SOLD UNDER THESE TERMS AND CONDITIONS WITH RESPECT TO WHICH LOSSES OR DAMAGES ARE CLAIMED. THE EXISTENCE OF MORE THAN ONE CLAIM AGAINST THE PARTICULAR UNITS SOLD TO USER UNDER THESE TERMS AND CONDITIONS SHALL NOT ENLARGE OR EXTEND THIS LIMIT.

9. *Return Policy.* Except as otherwise provided, TI does not offer any refunds, returns, or exchanges. Furthermore, no return of EVM(s) will be accepted if the package has been opened and no return of the EVM(s) will be accepted if they are damaged or otherwise not in a resalable condition. If User feels it has been incorrectly charged for the EVM(s) it ordered or that delivery violates the applicable order, User should contact TI. All refunds will be made in full within thirty (30) working days from the return of the components(s), excluding any postage or packaging costs.

10. *Governing Law:* These terms and conditions shall be governed by and interpreted in accordance with the laws of the State of Texas, without reference to conflict-of-laws principles. User agrees that non-exclusive jurisdiction for any dispute arising out of or relating to these terms and conditions lies within courts located in the State of Texas and consents to venue in Dallas County, Texas. Notwithstanding the foregoing, any judgment may be enforced in any United States or foreign court, and TI may seek injunctive relief in any United States or foreign court.

IMPORTANT NOTICE

Texas Instruments Incorporated and its subsidiaries (TI) reserve the right to make corrections, enhancements, improvements and other changes to its semiconductor products and services per JESD46, latest issue, and to discontinue any product or service per JESD48, latest issue. Buyers should obtain the latest relevant information before placing orders and should verify that such information is current and complete. All semiconductor products (also referred to herein as "components") are sold subject to TI's terms and conditions of sale supplied at the time of order acknowledgment.

TI warrants performance of its components to the specifications applicable at the time of sale, in accordance with the warranty in TI's terms and conditions of sale of semiconductor products. Testing and other quality control techniques are used to the extent TI deems necessary to support this warranty. Except where mandated by applicable law, testing of all parameters of each component is not necessarily performed.

TI assumes no liability for applications assistance or the design of Buyers' products. Buyers are responsible for their products and applications using TI components. To minimize the risks associated with Buyers' products and applications, Buyers should provide adequate design and operating safeguards.

TI does not warrant or represent that any license, either express or implied, is granted under any patent right, copyright, mask work right, or other intellectual property right relating to any combination, machine, or process in which TI components or services are used. Information published by TI regarding third-party products or services does not constitute a license to use such products or services or a warranty or endorsement thereof. Use of such information may require a license from a third party under the patents or other intellectual property of the third party, or a license from TI under the patents or other intellectual property of TI.

Reproduction of significant portions of TI information in TI data books or data sheets is permissible only if reproduction is without alteration and is accompanied by all associated warranties, conditions, limitations, and notices. TI is not responsible or liable for such altered documentation. Information of third parties may be subject to additional restrictions.

Resale of TI components or services with statements different from or beyond the parameters stated by TI for that component or service voids all express and any implied warranties for the associated TI component or service and is an unfair and deceptive business practice. TI is not responsible or liable for any such statements.

Buyer acknowledges and agrees that it is solely responsible for compliance with all legal, regulatory and safety-related requirements concerning its products, and any use of TI components in its applications, notwithstanding any applications-related information or support that may be provided by TI. Buyer represents and agrees that it has all the necessary expertise to create and implement safeguards which anticipate dangerous consequences of failures, monitor failures and their consequences, lessen the likelihood of failures that might cause harm and take appropriate remedial actions. Buyer will fully indemnify TI and its representatives against any damages arising out of the use of any TI components in safety-critical applications.

In some cases, TI components may be promoted specifically to facilitate safety-related applications. With such components, TI's goal is to help enable customers to design and create their own end-product solutions that meet applicable functional safety standards and requirements. Nonetheless, such components are subject to these terms.

No TI components are authorized for use in FDA Class III (or similar life-critical medical equipment) unless authorized officers of the parties have executed a special agreement specifically governing such use.

Only those TI components which TI has specifically designated as military grade or "enhanced plastic" are designed and intended for use in military/aerospace applications or environments. Buyer acknowledges and agrees that any military or aerospace use of TI components which have **not** been so designated is solely at the Buyer's risk, and that Buyer is solely responsible for compliance with all legal and regulatory requirements in connection with such use.

TI has specifically designated certain components as meeting ISO/TS16949 requirements, mainly for automotive use. In any case of use of non-designated products, TI will not be responsible for any failure to meet ISO/TS16949.

Products

Audio	www.ti.com/audio
Amplifiers	amplifier.ti.com
Data Converters	dataconverter.ti.com
DLP® Products	www.dlp.com
DSP	dsp.ti.com
Clocks and Timers	www.ti.com/clocks
Interface	interface.ti.com
Logic	logic.ti.com
Power Mgmt	power.ti.com
Microcontrollers	microcontroller.ti.com
RFID	www.ti-rfid.com
OMAP Applications Processors	www.ti.com/omap
Wireless Connectivity	www.ti.com/wirelessconnectivity

Applications

Automotive and Transportation	www.ti.com/automotive
Communications and Telecom	www.ti.com/communications
Computers and Peripherals	www.ti.com/computers
Consumer Electronics	www.ti.com/consumer-apps
Energy and Lighting	www.ti.com/energy
Industrial	www.ti.com/industrial
Medical	www.ti.com/medical
Security	www.ti.com/security
Space, Avionics and Defense	www.ti.com/space-avionics-defense
Video and Imaging	www.ti.com/video

TI E2E Community

e2e.ti.com