

DS90UH949A-Q1EVM or DS90UB949A-Q1EVM

User's Guide



Literature Number: SNLU232A
August 2018–Revised May 2019

1	DS90UH949A-Q1EVM or DS90UB949A-Q1EVM User's Guide	5
1.1	General Description	5
1.2	Features.....	6
1.3	System Requirements.....	6
1.4	Contents of the Demo Evaluation Kit	6
1.5	Applications Diagram.....	7
1.6	Typical Configuration	7
1.7	Quick Start Guide	8
1.8	Default Jumper Settings.....	10
1.9	Default Switch Settings.....	10
1.10	Demo Board Connections.....	11
1.11	ALP Software Setup	14
1.11.1	System Requirements	14
1.11.2	Download Contents	14
1.11.3	Installation of the ALP Software	14
1.11.4	Start-Up - Software Description	15
1.11.5	Information Tab.....	17
1.11.6	HDMI Tab	18
1.11.7	Pattern Generator Tab.....	19
1.11.8	Registers Tab.....	20
1.11.9	Registers Tab - Address 0x00 Selected	21
1.11.10	Registers Tab - Address 0x00 Expanded	22
1.11.11	Scripting Tab	23
1.12	Troubleshooting ALP Software	24
1.12.1	ALP Loads the Incorrect Profile	24
1.12.2	ALP Does Not Detect the EVM.....	26
1.13	Typical Connection and Test Equipment.....	28
1.14	Equipment References	29
1.15	Cable References	29
2	Bill of Materials	30
A	EVM PCB Schematics	39
B	Board Layout	48
	Revision History	57

List of Figures

1-1.	Applications Diagram	7
1-2.	Typical Configuration	7
1-3.	Interfacing to the EVM	9
1-4.	Launching ALP	15
1-5.	Initial ALP Screen	16
1-6.	Follow-Up Screen	16
1-7.	ALP Information Tab	17
1-8.	ALP HDMI Tab	18
1-9.	ALP Pattern Generator Tab	19
1-10.	ALP Registers Tab	20
1-11.	ALP Device ID Selected	21
1-12.	ALP Device ID Expanded	22
1-13.	ALP Scripting Tab	23
1-14.	USB2ANY Setup	24
1-15.	Remove Incorrect Profile	24
1-16.	Add Correct Profile	25
1-17.	Finish Setup	25
1-18.	ALP No Devices Error	26
1-19.	Windows 7, ALP USB Driver	26
1-20.	ALP in Demo Mode	27
1-21.	ALP Preferences Menu	27
1-22.	Typical Test Setup for Video Application	28
1-23.	Typical Test Setup for Evaluation	28
A-1.	Schematic - Block Diagram	39
A-2.	Schematic - DS90UH949A-Q1 and Power Decoupling	40
A-3.	Schematic - MSP430	41
A-4.	Schematic - PDB, IDx and MODE_SEL Switches	42
A-5.	Schematic - HDMI, HSD, SMA, I2C, DDC, CEC and GPIO/I2S/SPI Connectors	43
A-6.	Schematic - LEDs	44
A-7.	Schematic - Audio (Not Populated)	45
A-8.	Schematic - Power Regulators	46
A-9.	Schematic - Hardware	47
B-1.	Board Layer - Top Overlay	48
B-2.	Board Layer - Top Solder	49
B-3.	Board Layer - Top	50
B-4.	Board Layer - Ground-1	51
B-5.	Board Layer - Signal Layer	52
B-6.	Board Layer - Power Split/GND	53
B-7.	Board Layer - Ground - 2	54
B-8.	Board Layer - Bottom	55
B-9.	Board Layer - Bottom Solder	56

List of Tables

1-1.	Default Board Jumper Settings	10
1-2.	Default Board Switch Settings	10
1-3.	Power Supply	11
1-4.	FPD-Link III Output Signals P1 (HSD Connector)	11
1-5.	Alternative SMA FPD-Link III Output Signals (Note: SMAs are Not Connected by Default From the Factory)	11
1-6.	HDMI Input Signals	11
1-7.	USB2ANY Connector	11
1-8.	I2C/CCI Interface Header J25	11
1-9.	GPIO/Audio Interface	12
1-10.	SPI/D_GPIO Interface	12
1-11.	MODE_SEL[1:0] Settings	12
1-12.	Configuration Select (MODE_SEL0) -- SW-DIP8 - S2	12
1-13.	Configuration Select (MODE_SEL1) - SW-DIP8 - S6	13
1-14.	IDx SW-DIP8 - S3	13
2-1.	Bill of Materials	30

DS90UH949A-Q1EVM or DS90UB949A-Q1EVM User's Guide

1.1 General Description

The DS90Ux949A-Q1EVM (Evaluation Module) converts HDMI to FPD-Link III. This kit will demonstrate the functionality and operation of the DS90Ux949A-Q1. The DS90Ux949A-Q1 is an HDMI to FPD-Link III serializer which, in conjunction with the DS90Ux940-Q1/DS90Ux948-Q1 deserializers, takes the data from HDMI serial stream and translates it into either single- or dual-lane FPD-Link III interface. The DS90Ux949A-Q1 supports video resolutions up to 210 MHz for 3K (2880x1620) with 24-bit color depth.

The FPD-Link III interface supports video and audio data transmission and full duplex control, including I2C and SPI communication, over the same differential link. In backward-compatible mode, the device supports up to WXGA and 720p resolutions with 24-bit color depth over a single differential link.

The device supports up to 7.1 audio channels. Audio data received from the HDMI stream is encrypted, serialized, and sent out on the FPD-Link III stream to a compatible deserializer. Up to 8-channel I2S interface with maximum bit rate of 192 kHz.

The demo board is not intended for EMI testing. The demo board was designed for easy accessibility to device pins with tap points for monitoring or applying signals, additional pads for termination, and multiple connector options.

In this document:

1. The DS90UH949A-Q1EVM and DS90UB949A-Q1EVM devices are referred to as DS90Ux949A-Q1EVM.
2. The DS90UH949A-Q1 and DS90UB949A-Q1 devices are referred to as DS90Ux949A-Q1.
3. The DS90UH926-Q1 and DS90UB926-Q1 devices are referred to as DS90Ux926-Q1.
4. The DS90UH928-Q1 and DS90UB928-Q1 devices are referred to as DS90Ux926-Q1.
5. The DS90UH948-Q1 and DS90UB948-Q1 devices are referred to as DS90Ux948-Q1.
6. The DS90UH940-Q1 and DS90UB940-Q1 devices are referred to as DS90Ux940-Q1.

1.2 Features

- Supports pixel clock frequency up to 210 MHz for 3K (2880x1620) and 1080p60 resolutions with 24-bit color depth
- HDMI receiver to accept HDMI as input
- Dual FPD-Link III output interface
 - Single channel: up to 105-MHz pixel clock
 - Dual channel: up to 210-MHz pixel clock
- Supports single-ended coaxial or differential shielded twisted-pair (STP/Q) cables
- Backward-compatible to DS90Ux926Q-Q1, DS90Ux928-Q1, DS90Ux940-Q1, and DS90Ux948-Q1 FPD-Link III deserializers
- @Speed BIST
- Supports 7.1 multiple I2S (4 data) channels
- Single +12-V power supply for EVM
- 1.8-V LVCMOS I/O interface
- 1.8-V or 3.3-V compatible LVCMOS I2C interface
- Automotive grade product: AEC-Q100 grade 2 qualified

1.3 System Requirements

To demonstrate, the following is required:

1. FPD-Link III compatible deserializer
 1. DS90Ux940-Q1, DS90Ux948-Q1 up to 1080p60
 2. DS90Ux926Q-Q1, DS90Ux928-Q1 up to 720p60
2. HDMI source
3. Optional I2C controller
4. 12-V power supply at approximately 1 A (required)

1.4 Contents of the Demo Evaluation Kit

1. One EVM board with the DS90Ux949A-Q1

1.5 Applications Diagram

Figure 1-1 and Figure 1-2 show the use of the chipset in a display application.

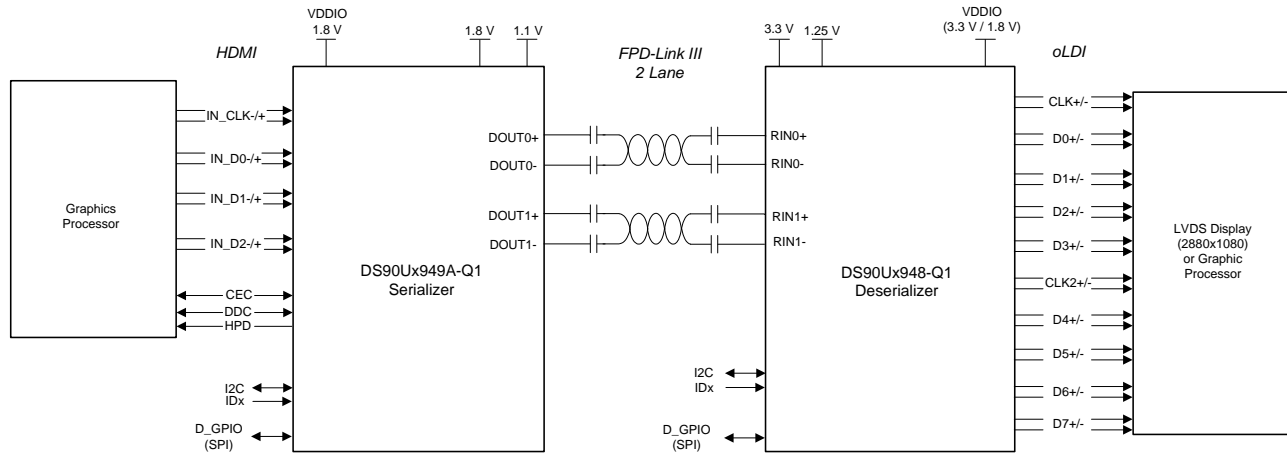

HDMI – High Definition Multimedia Interface
 HDCP* – High-Bandwidth Content Protection
 * Only on DS90UH devices

Figure 1-1. Applications Diagram

1.6 Typical Configuration

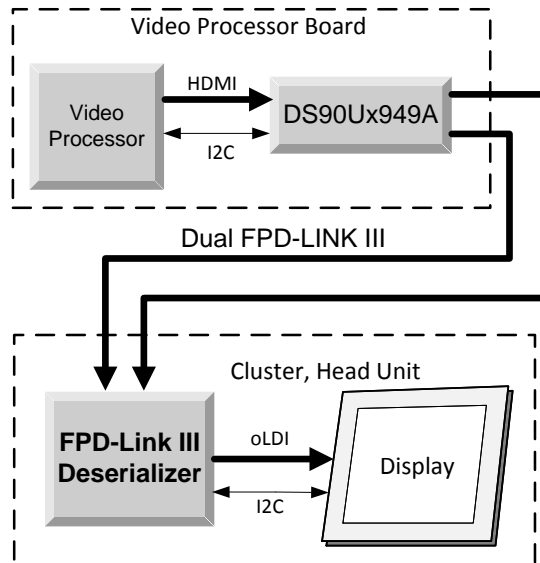

Figure 1-2. Typical Configuration

1.7 Quick Start Guide

1. Configure switches S2, S3, and S6 to set the operating modes of the device
 - S2: MODE_SEL0 = S2 switch position 1 = ON, all other switch positions = OFF (default factory setting)
 - S3: IDx = 0x18; S3 switch position 1 = ON, all other switch positions = OFF (default factory setting)
 - S6: MODE_SEL1 = S6 switch ; position 1 = ON, all other switch positions = OFF (default factory setting)
2. Connect P1 (DOUT[1:0]±) to the compatible deserializer (for example, the DS90Ux940-Q1EVM or DS90Ux948-Q1EVM using a STP cable (default))
3. Connect J8 to 12 V.
 - a. Optional power options available (see [Table 1-3](#))
4. Plug in the HDMI source
5. Connect J34 with the miniUSB cable to PC USB port (5-pin_ to USB A (4-pin))

For details of pin names and pin functions, see the DS90Ux949A-Q1 datasheet.

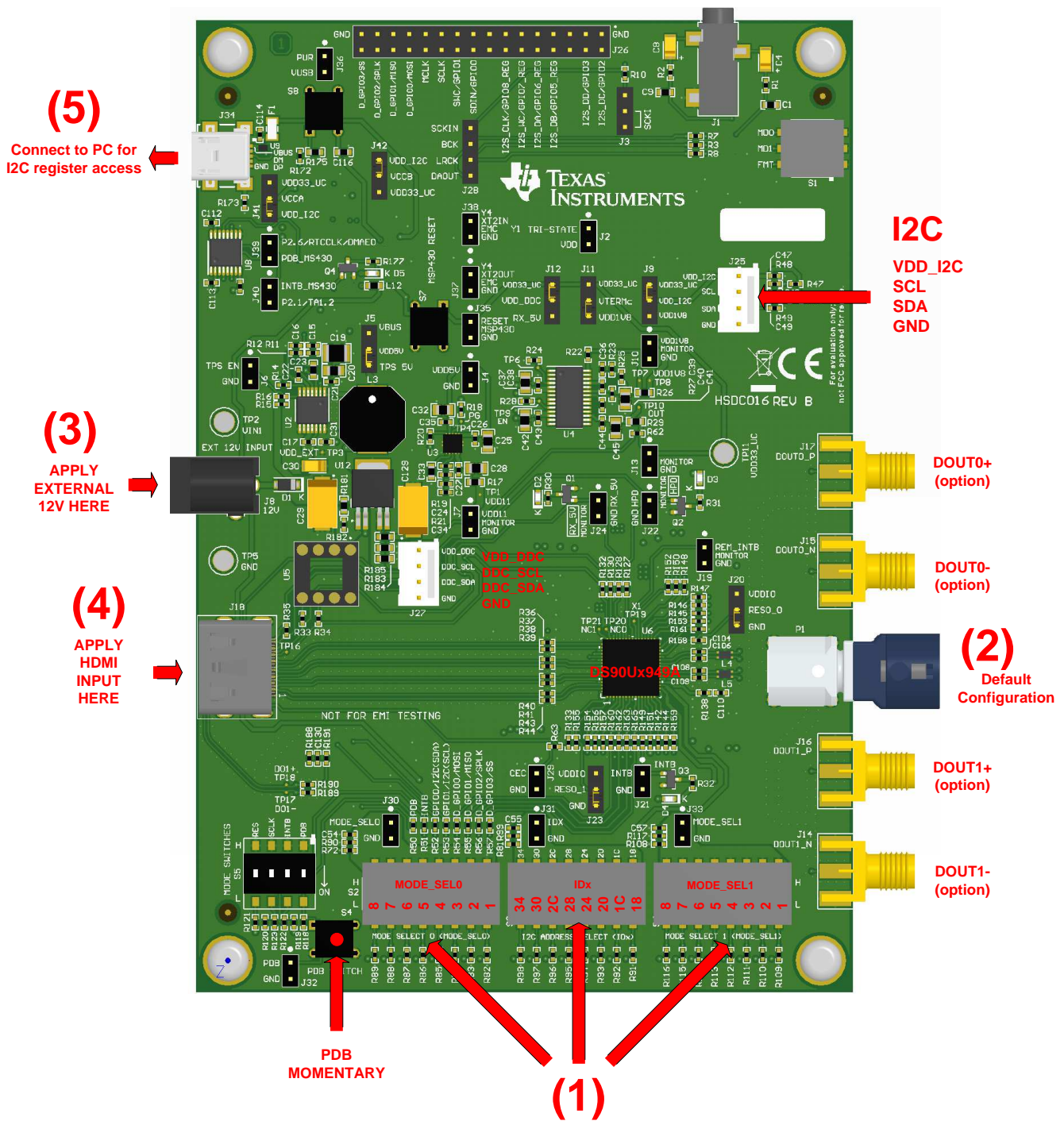

Figure 1-3. Interfacing to the EVM

1.8 Default Jumper Settings

Ensure that the board has the default board jumper settings:

Table 1-1. Default Board Jumper Settings

Jumper	Jumper Settings
J5	Connect 2 and 3
J9	Connect 2 and 3
J11	Connect 2 and 3
J12	Connect 2 and 3
J20	Connect 2 and 3
J23	Connect 2 and 3
J40	Connect 2 and 3
J41	Connect 2 and 3

1.9 Default Switch Settings

Ensure that the board has the default board switch settings:

Table 1-2. Default Board Switch Settings

Switch	Switch Settings
S2	1 ON (silk screen L side), 2-8 OFF (silk screen H side)
S3	1 ON (silk screen L side), 2-8 OFF (silk screen H side)
S6	1 ON (silk screen L side), 2-8 OFF (silk screen H side)
S5	1-2 OFF (silk screen H side), 3-4 ON (silk screen L side)

1.10 Demo Board Connections

Table 1-3. Power Supply

Designator	Signal	Description
J8	+12 V	12-V \pm 5% Main Power, Single +12-V power connector that supplies power to the entire board.
J7.1 (Optional)	+1.1 V	1.1-V \pm 5%, Alternative to Main Power. If used, remove R17.
J10.1 (Optional)	+1.8 V	1.8-V \pm 5%, Alternative to Main Power. If used, remove R26.
J13.1 (Optional)	+3.3 V	3.3-V \pm 5%, Alternative to Main Power. If used, remove R29.
J4.1 (Optional)	+5 V	5-V \pm 5%, Alternative to Main Power. If used, remove R13.

Table 1-4. FPD-Link III Output Signals P1 (HSD Connector)

Designator	Port	Signal
P1.1	FPD-Link III Port 0	DOUT0–
P1.3		DOUT0+
P1.2	FPD-Link III Port 1	DOUT1–
P1.4		DOUT1+

**Table 1-5. Alternative SMA FPD-Link III Output Signals
(Note: SMAs are Not Connected by Default From the Factory)**

Designator	Port	Signal
J15	FPD-Link III Port 0	DOUT0–
J17		DOUT0+
J14	FPD-Link III Port 1	DOUT1–
J15		DOUT1+

Table 1-6. HDMI Input Signals

Designator	Signal	Description
J18.12 J18.10	IN_CLK- IN_CLK+	HDMI TMDS clock input
J18.9 J18.7	IN_D0- IN_D0+	HDMI TMDS data0 input
J18.6 J18.4	IN_D1- IN_D1+	HDMI TMDS data1 input
J18.3 J18.1	IN_D2- IN_D2+	HDMI TMDS data2 input

Table 1-7. USB2ANY Connector

Designator	Description
J34	mini USB 5 pin

Table 1-8. I2C/CCI Interface Header J25

Designator	Signal
J25.1	VDDI2C
J25.2	SCL
J25.3	SDA
J25.4	GND

Table 1-9. GPIO/Audio Interface

Designator	Signal	Description
J26.18	SDIN/GPIO0	Aux I2S Data Input / Remote or Local I/O
J26.20	SWC/GPIO1	Aux I2S Word Clock Output / Remote or Local I/O
J26.2	I2S_DC/GPIO2	I2S Data Input / Remote or Local I/O
J26.4	I2S_DD/GPIO3	I2S Data Input / Remote or Local I/O
J26.8	I2S_DB/GPIO5_RE G	I2S Data Input / Local only I/O
J26.10	I2S_DA/GPIO6_RE G	I2S Data Input / Local only I/O
J26.12	I2S_WC/GPIO7_RE G	I2S Word Clock Input / Local only I/O
J26.14	I2S_CLK/GPIO8_RE G	I2S Clock Input / Local only I/O
J26.24	MCLK	I2S System Clock Output

Table 1-10. SPI/D_GPIO Interface

Designator	Signal	Description
J26.32	D_GPIO3/SS	I/O in Dual FPD-Link III mode / Slave Select
J26.30	D_GPIO2/SCLK	I/O in Dual FPD-Link III mode / Serial Clock
J26.28	D_GPIO1/MISO	I/O in Dual FPD-Link III mode / Master In, Slave Out
J26.26	D_GPIO0/MOSI	I/O in Dual FPD-Link III mode / Master Out, Slave In

Configuration of the device may be done through the MODE_SEL[1:0]. These modes are latched into register location during power up:

Table 1-11. MODE_SEL[1:0] Settings

Mode	Setting	Function
EDID_SEL: Display ID Select	0	Look for remote EDID, if none found, use internal SRAM EDID. Can be overridden from register. Remote EDID address may be overridden from default 0xA0.
	1	Use external local EDID.
AUTO-SS: Auto Sleep-State	0	Disable.
	1	Enable.
AUX_I2S: AUX Audio Channel	0	HDMI audio.
	1	HDMI + AUX audio channel.
EXT_CTL: External Controller Override	0	Internal HDCP/HDMI control.
	1	External HDCP/HDMI control from I2C interface pins.
COAX: Cable Type	0	Enable FPD-Link III for twisted pair cabling.
	1	Enable FPD-Link III for coaxial cabling.
REM_EDID_LOAD: Remote EDID Load	0	Use internal SRAM EDID.
	1	If available, remote EDID is copied into internal SRAM EDID.

Table 1-12. Configuration Select (MODE_SEL0) -- SW-DIP8 - S2⁽¹⁾

MODE #	EDID_SEL	AUX_I2S
1	0	0
2	0	1
3	1	0
4	1	1

⁽¹⁾ Only set one high.

Table 1-13. Configuration Select (MODE_SEL1) - SW-DIP8 - S6⁽¹⁾

MODE #	EXT_CTL	COAX	REM_EDID_LOAD
1	0	0	0
2	0	0	1
3	0	1	0
4	0	1	1
5	1	0	0
6	1	0	1
7	1	1	0
8	1	1	1

⁽¹⁾ Only set one high.

The strapped values can be viewed and/or modified in the following locations:

- EDID_SEL: Latched into BRIDGE_CTL[0], EDID_DISABLE (0x4F[0]).
- AUX_I2S: Latched into BRIDGE_CFG[1], AUDIO_MODE[1] (0x54[1]).
- EXT_CTL: Latched into BRIDGE_CFG[7], EXT_CONTROL (0x54[7]).
- COAX: Latched into DUAL_CTL1[7], COAX_MODE (0x5B[7]).
- REM_EDID_LOAD: Latched into BRIDGE_CFG[5] (0x54[5]).

Table 1-14. IDx SW-DIP8 - S3⁽¹⁾

Designator	7-Bit Address	8-Bit Address
S3.1 (Default)	0x0C	0x18
S3.2	0x0E	0x1C
S3.3	0x10	0x20
S3.4	0x12	0x24
S3.5	0x14	0x28
S3.6	0x16	0x2C
S3.7	0x18	0x30
S3.8	0x1A	0x34

⁽¹⁾ Only set one high.

1.11 ALP Software Setup

1.11.1 System Requirements

Operating System:	Windows 7 64-bit
USB:	USB2ANY
USB2ANY Firmware Version:	2.5.2.0

1.11.2 Download Contents

TI Analog LaunchPAD can be downloaded from: <http://www.ti.com/tool/alp>.

Download and extract the “snlc048.zip” file to a temporary location that can be deleted later.

Make sure J34 on the DS90Ux949A-Q1EVM is connected to a PC USB port with USB cable and power is applied to the DS90Ux949A-Q1EVM.

The following installation instructions are for the Windows 7 64-bit Operating System.

1.11.3 Installation of the ALP Software

Execute the ALP Setup Wizard program called “ALPF_setup_v_x_x_x.exe” that was extracted to a temporary location on the local drive of your PC.

There are 7 installation steps after the setup wizard starts:

1. Click the "Next" button in the ALP Setup Wizard to start the installation.
2. Select “I accept the agreement” and then click the “Next” button.
3. Select the location to install the ALP software and then click the “Next” button.
4. Select the location for the start menu shortcut and then click the “Next” button.
5. Create the desktop icon on the next screen. After selecting the desired choices, click the “Next” button.
6. Click the “Install” button to install the software in the selected location.
7. Uncheck “Launch Analog LaunchPAD” and click the “Finish” button. The ALP software can start if “Launch Analog LaunchPAD” is checked, but it will not be useful until the USB driver is installed and board is attached.

Connect the J34 USB jack of the DS90Ux949A-Q1EVM board to a PC or laptop USB port using a Type A

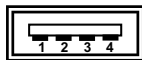

A



MINI

USB cable. Power the DS90Ux949A-Q1EVM board with a 12-VDC power supply to launch the “Found New Hardware Wizard” on the PC or laptop.

1.11.4 Start-Up - Software Description

Make sure all the software has been installed and the hardware is powered on and connected to the PC. Execute "Analog LaunchPAD" shortcut from the start menu. The default start menu location is under All Programs → Texas Instruments → Analog LaunchPAD vx.x.x → Analog LaunchPAD to start MainGUI.exe.



Figure 1-4. Launching ALP

The application should come up in the state shown in [Figure 1-5](#). If it does not, see [Section 1.12](#), "Troubleshooting ALP Software".

NOTE: The ALP window graphics in this document show "DS90UH949", and the document text refers to the DS90Ux949. Replace the "DS90Ux949" text with "DS90UH949" if you have the DS90UH949A-Q1EVM or "DS90UB949" if you have the DS90UB949A-Q1EVM.

Under the Devices tab, select "DS90UH949" for the DS90UB949A-Q1EVM or "DS90UH949" for the DS90UB949A-Q1EVM to open up the device profile with its associated tabs.

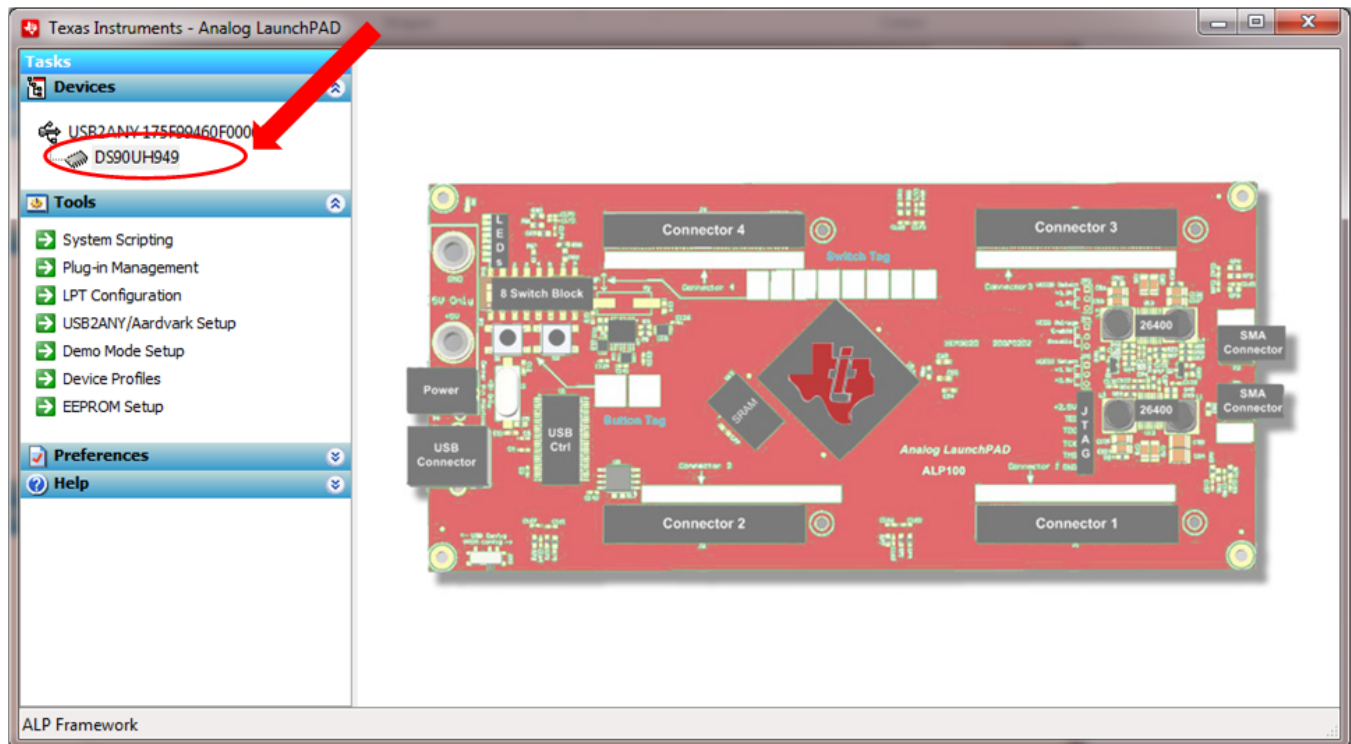

Figure 1-5. Initial ALP Screen

After selecting the DS90Ux949, the screen shown in Figure 1-6 should appear.

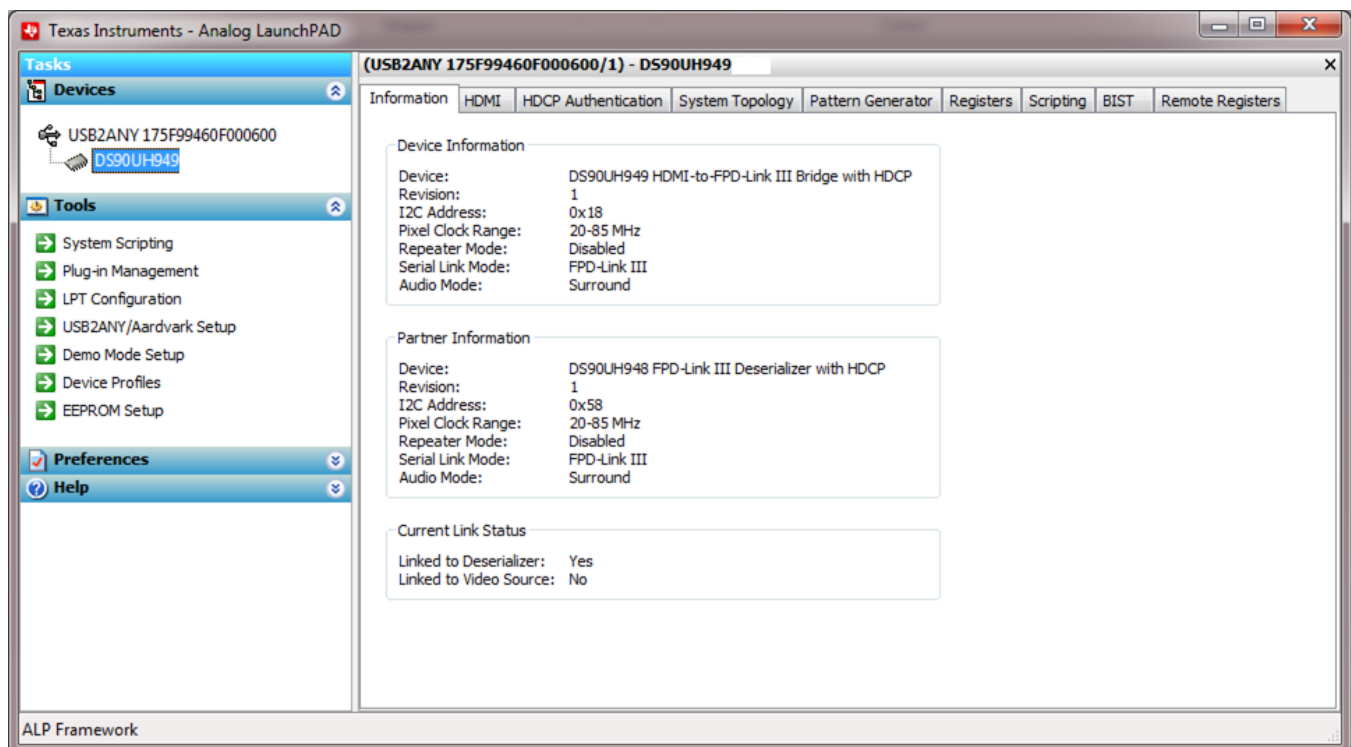

Figure 1-6. Follow-Up Screen

1.11.5 Information Tab

The Information tab is shown in [Figure 1-7](#). Note the device revision could be different.

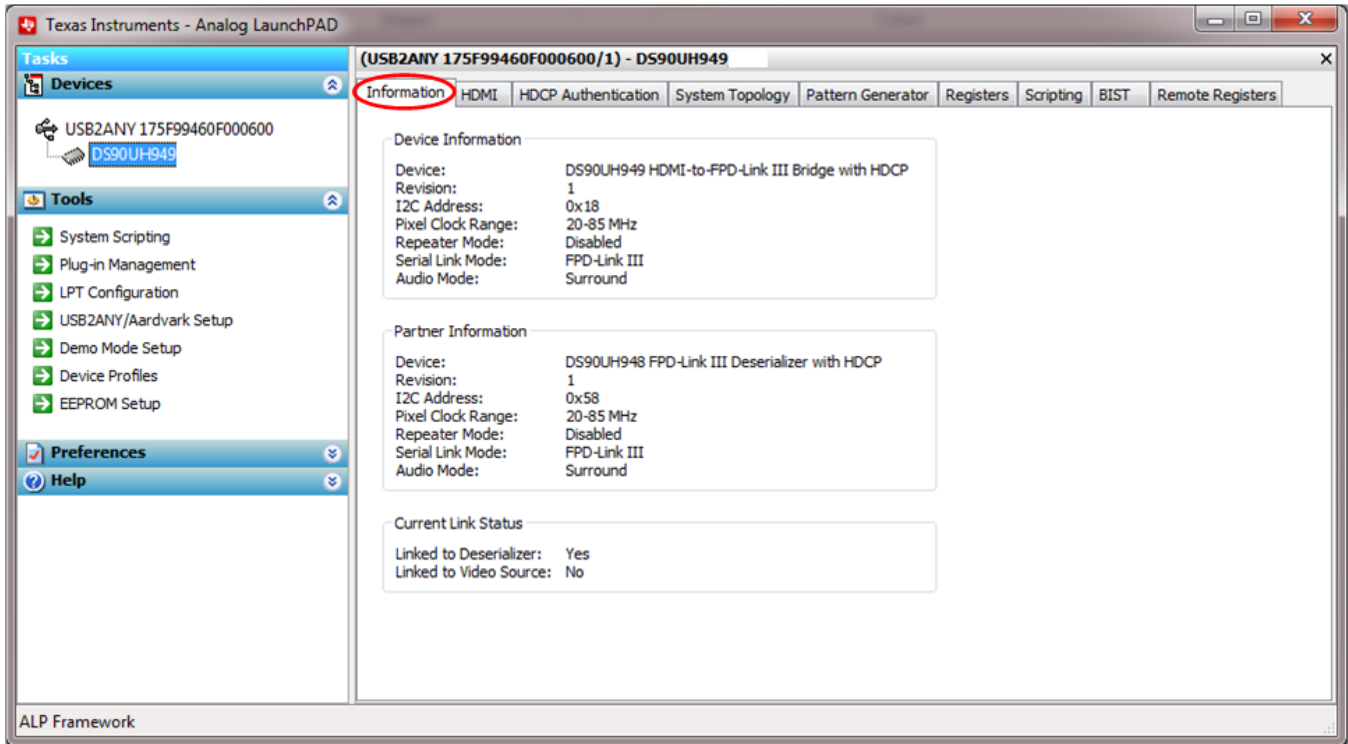

Figure 1-7. ALP Information Tab

1.11.6 HDMI Tab

The HDMI tab is shown in [Figure 1-8](#).

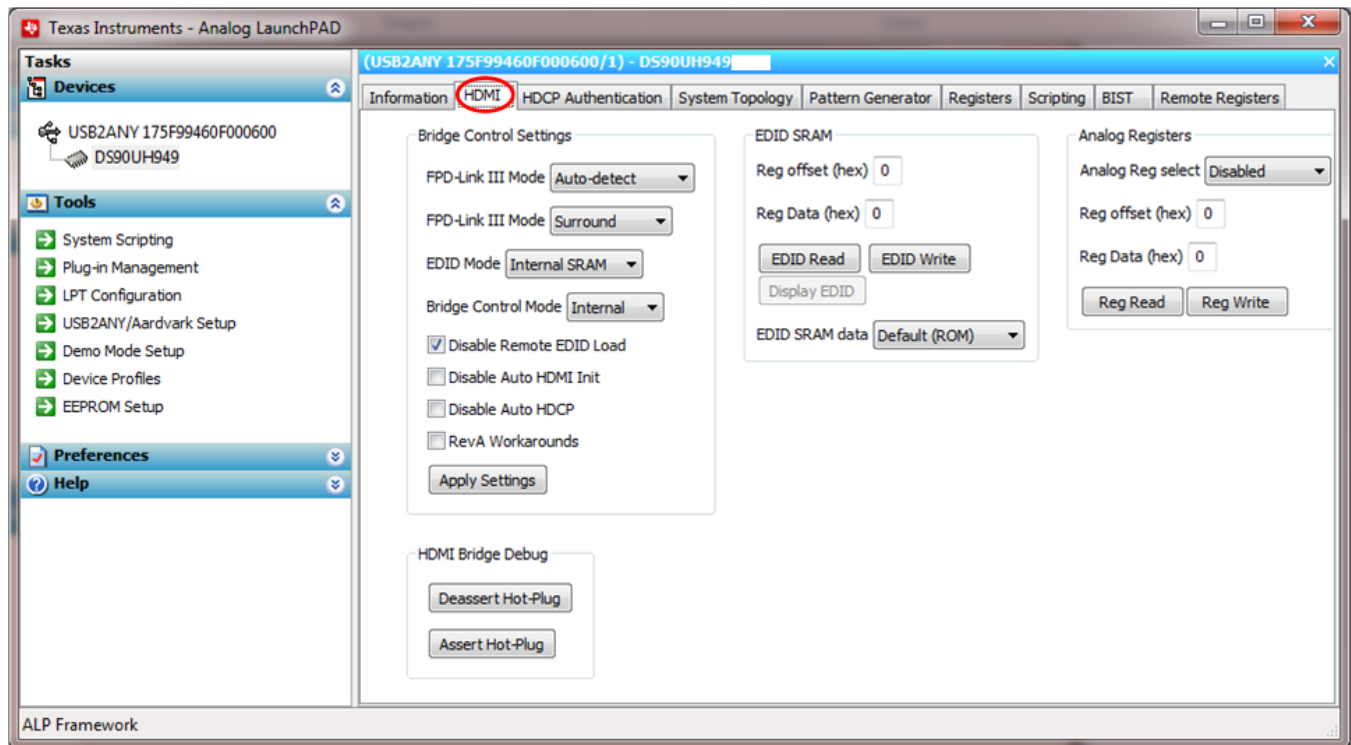

Figure 1-8. ALP HDMI Tab

1.11.7 Pattern Generator Tab

The SER Pattern Generator tab is shown in [Figure 1-9](#).

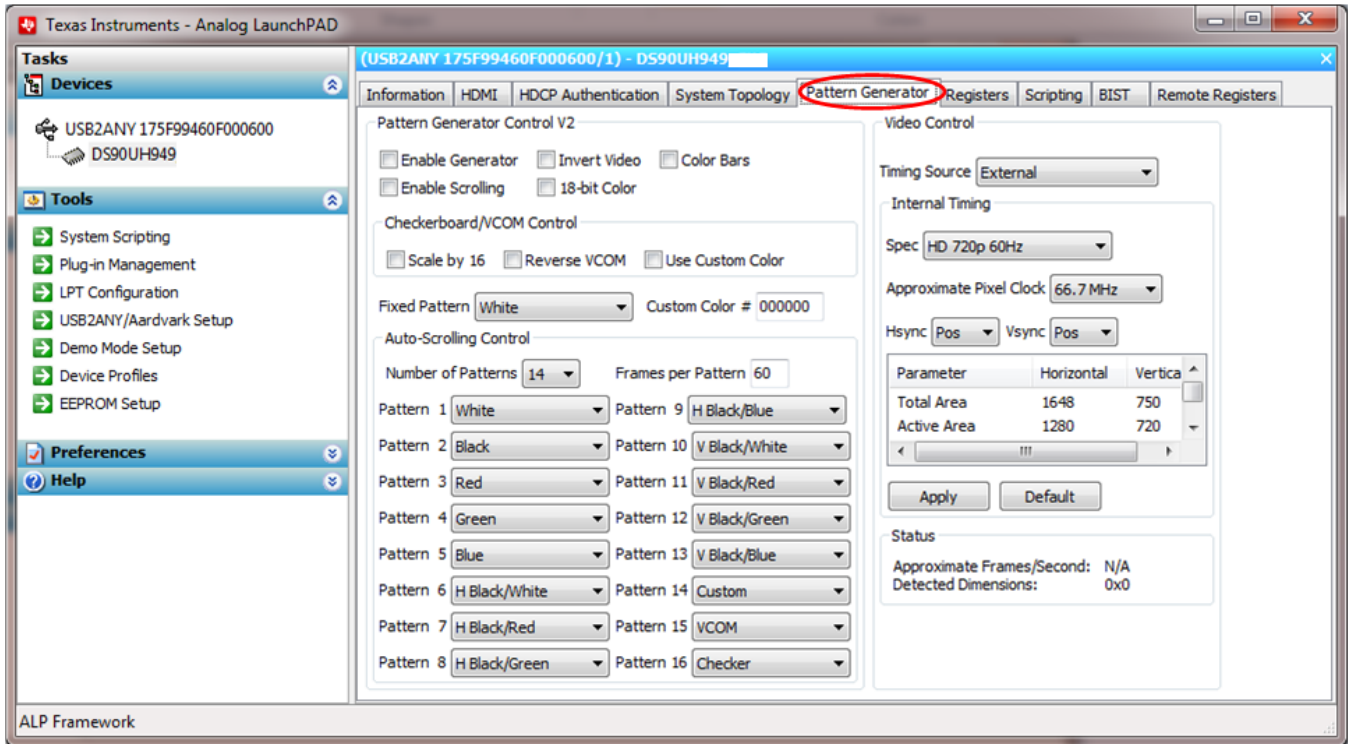

Figure 1-9. ALP Pattern Generator Tab

1.11.8 Registers Tab

The Registers tab is shown in [Figure 1-10](#).

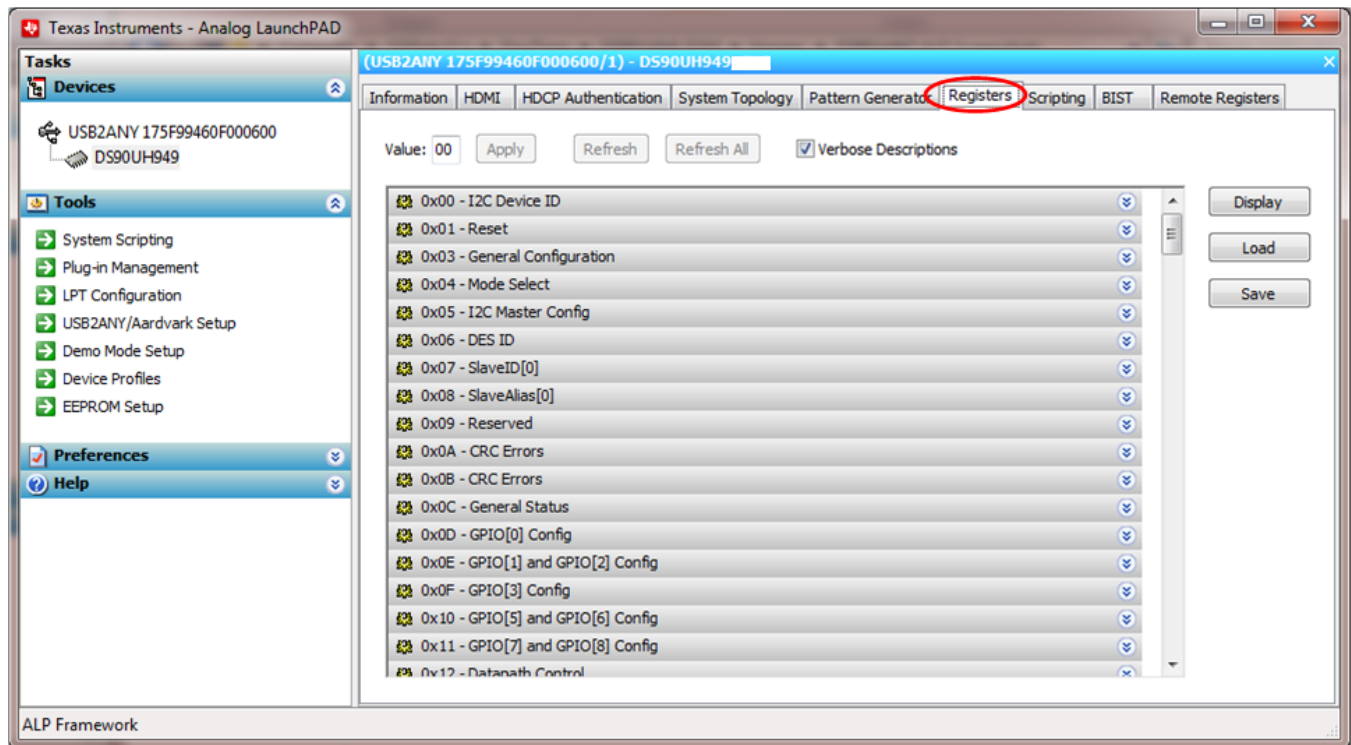

Figure 1-10. ALP Registers Tab

1.11.9 Registers Tab - Address 0x00 Selected

Address 0x00 selected as shown in [Figure 1-11](#). Note that the “Value:” box, Value: 18, will now show the hex value of that register.

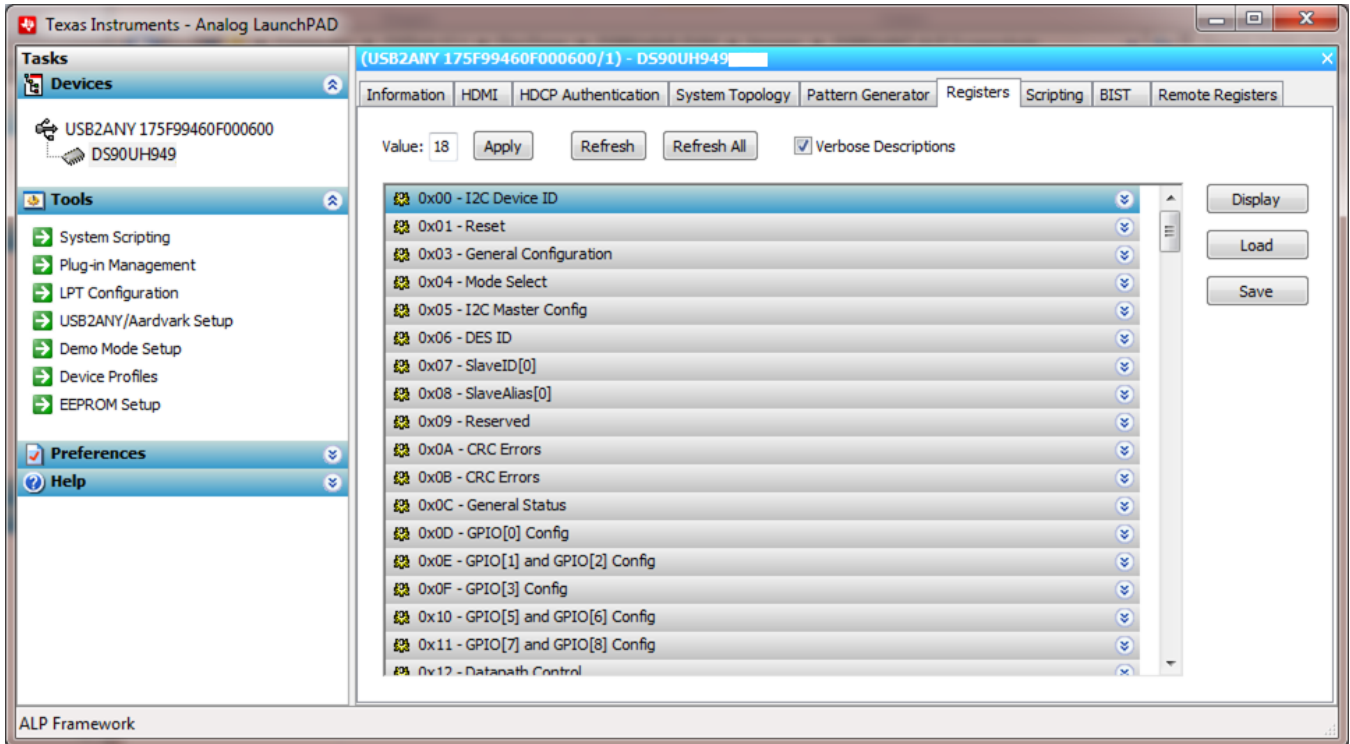

Figure 1-11. ALP Device ID Selected

1.11.10 Registers Tab - Address 0x00 Expanded

Double-click on the Address bar

 or single-click the  to expand the Address 0x00 content by bits. Any register address displayed can be expanded.

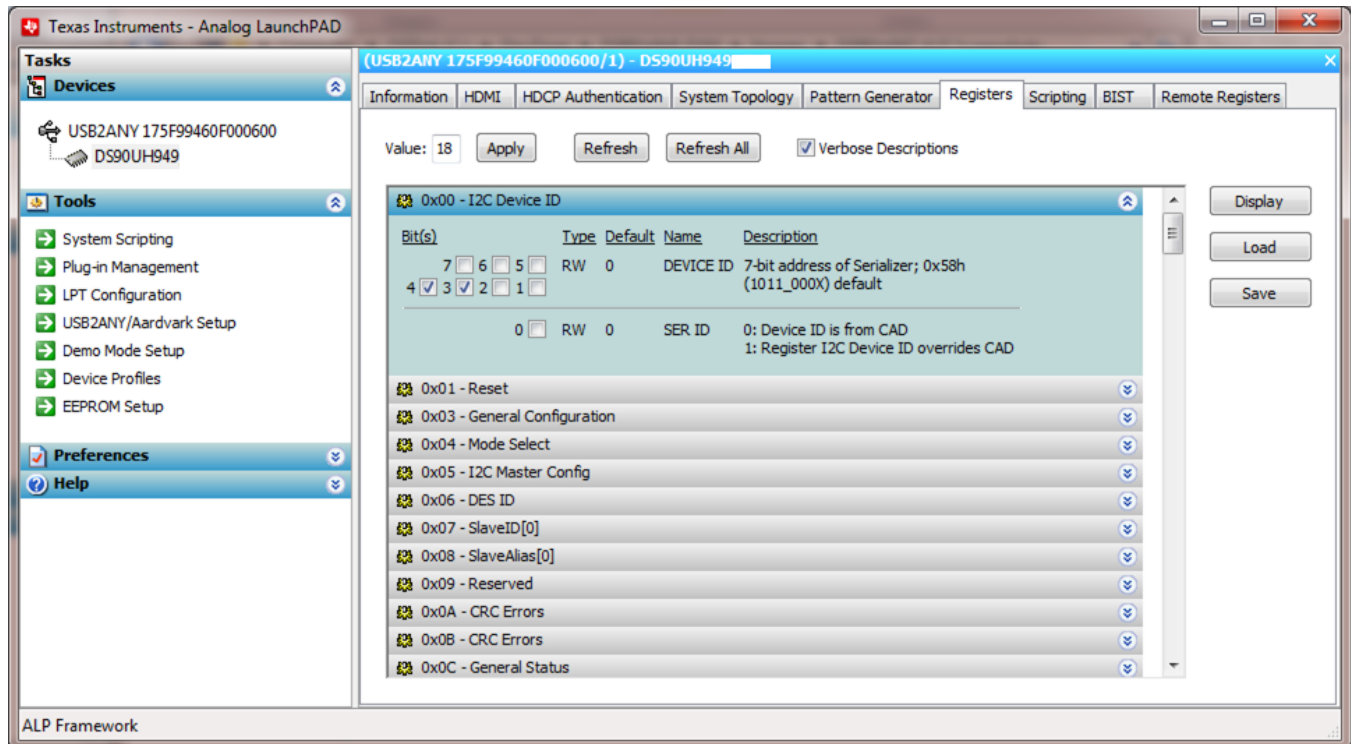

Figure 1-12. ALP Device ID Expanded

Type

Any RW Type register (**RW**) can be written into by either:

- writing the hex value into the “Value:” box (Value:)
- putting the pointer into the individual register bit(s) box by a left mouse click to put a check mark (indicating a “1”),
- unchecking the check mark (indicating a “0”).

Click “Apply” to write to the register and “Refresh” to see the new value of the selected (highlighted) register.

The box toggles on every mouse click.

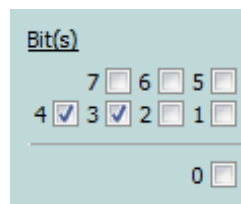

1.11.11 Scripting Tab

The Scripting tab is shown in Figure 1-13.

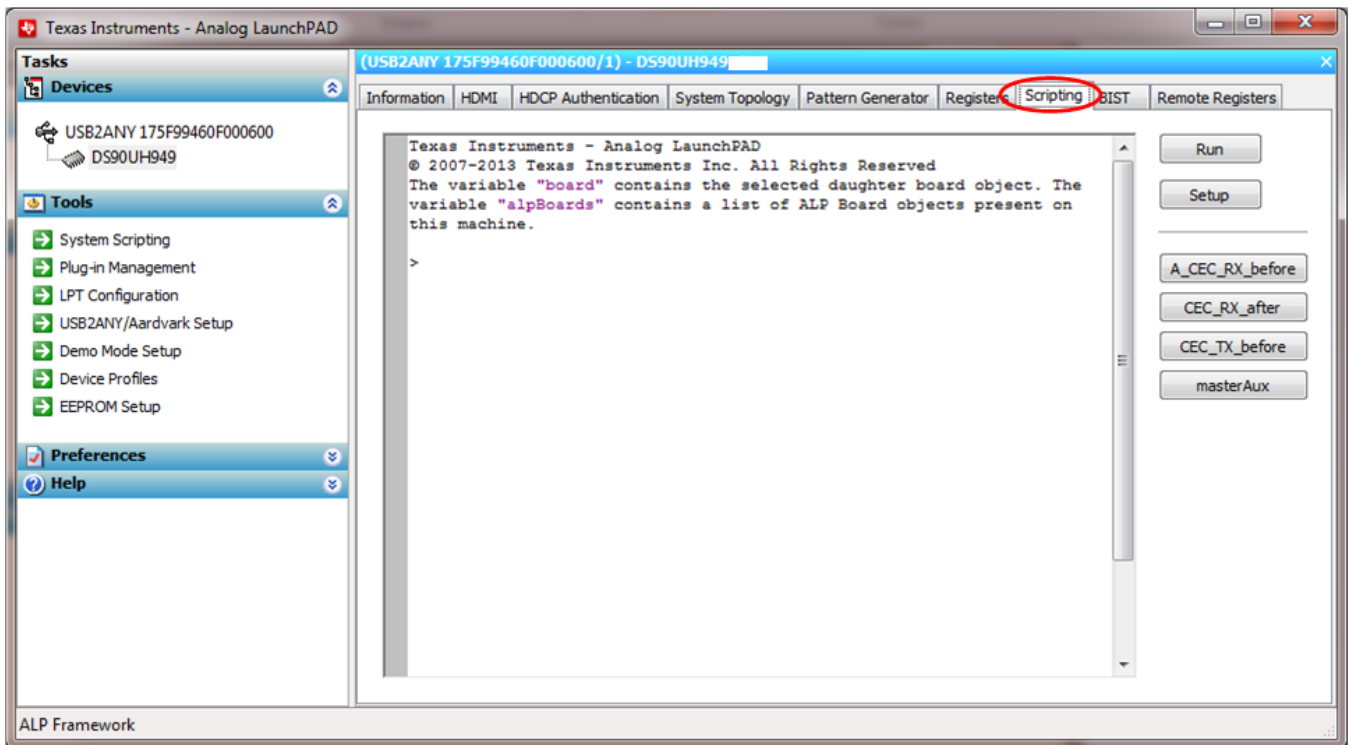

Figure 1-13. ALP Scripting Tab

The script window provides a full Python scripting environment that can be used for running scripts and interacting with the device in an interactive or automated fashion.

WARNING

Directly interacting with devices either through register modifications or by calling the device support library functions can effect the performance and/or functionality of the user interface and may even crash the ALP Framework application.

1.12 Troubleshooting ALP Software

1.12.1 ALP Loads the Incorrect Profile

If ALP opens with the incorrect profile loaded, the correct profile can be loaded from the USB2ANY/Aardvark Setup found under the tools menu.

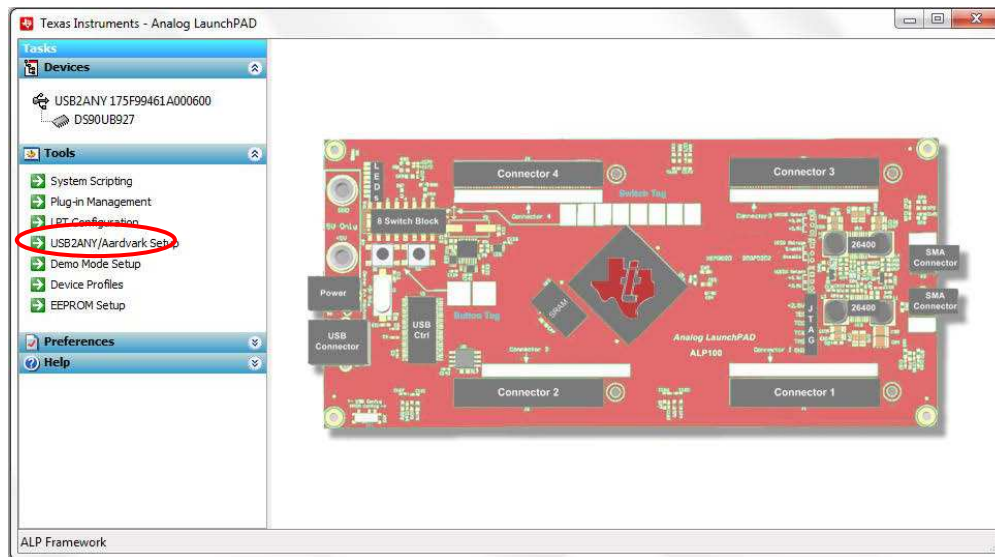

Figure 1-14. USB2ANY Setup

1. Highlight the incorrect profile in the Defined ALP Devices list and click the remove button.

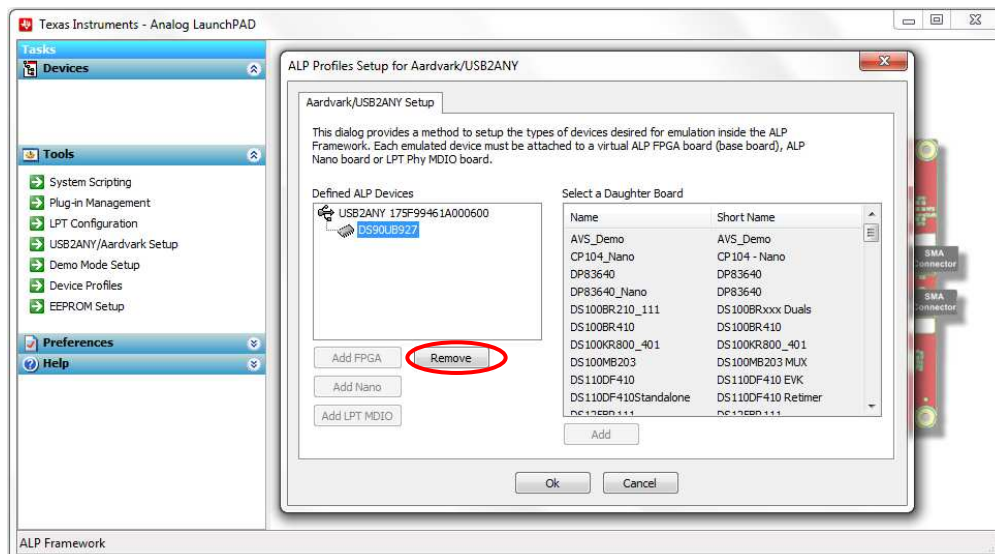

Figure 1-15. Remove Incorrect Profile

2. Find the correct profile under the Select a Daughter Board list, highlight the profile, and click Add.

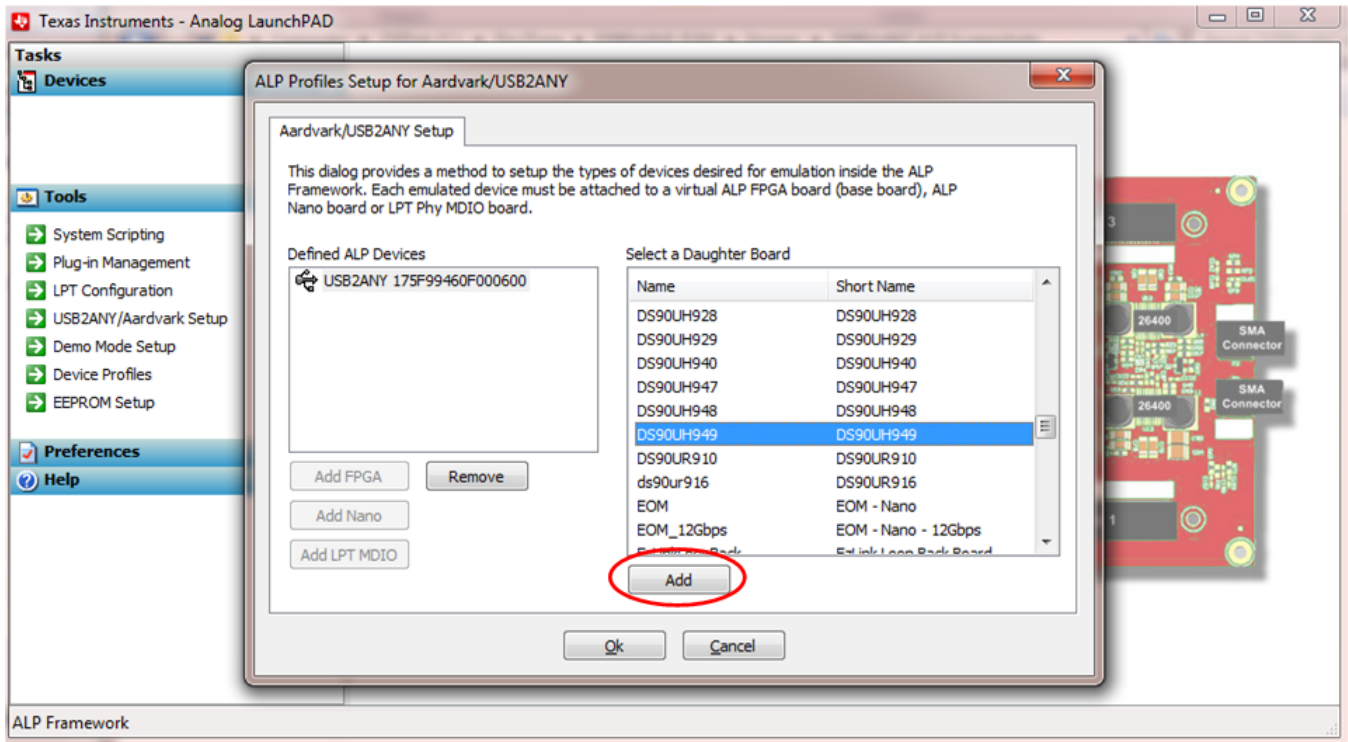

Figure 1-16. Add Correct Profile

3. Click Ok and the correct profile should load.

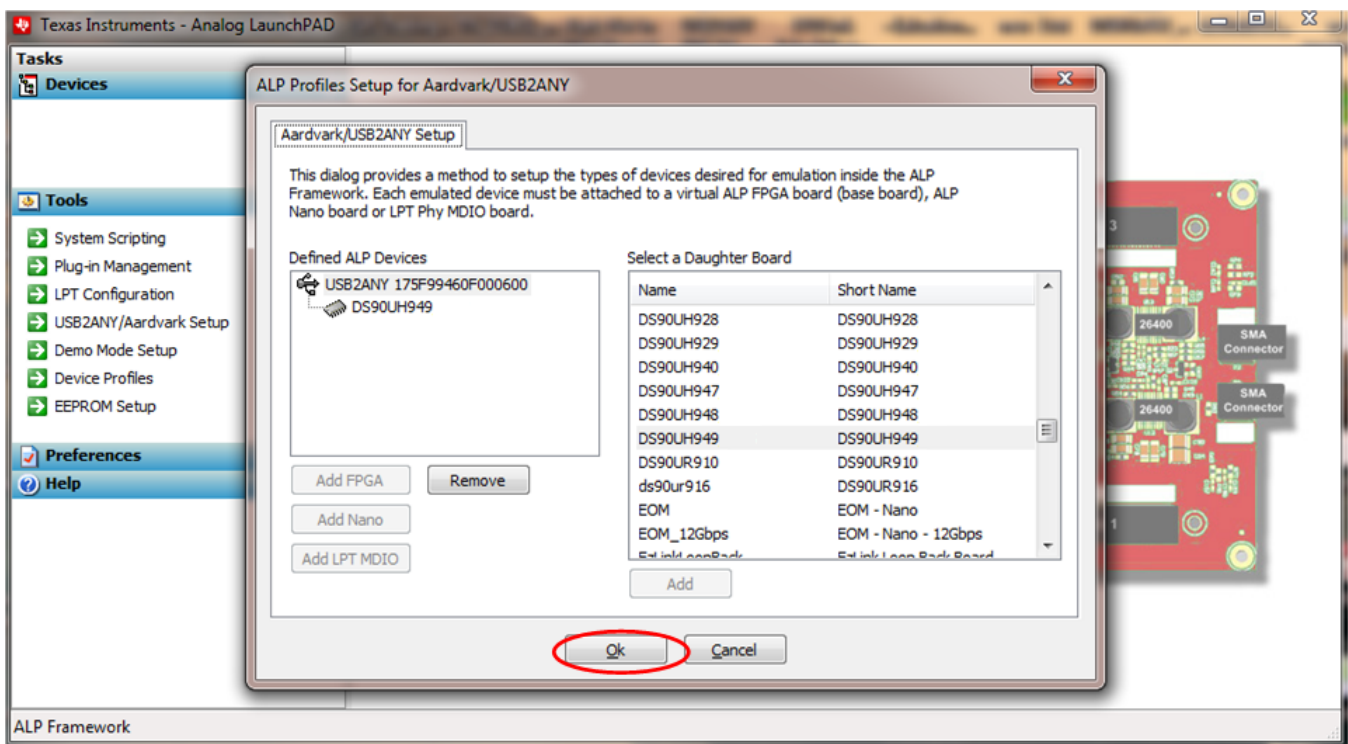

Figure 1-17. Finish Setup

1.12.2 ALP Does Not Detect the EVM

If the window shown in [Figure 1-18](#) opens after starting the ALP software, double check the hardware setup.

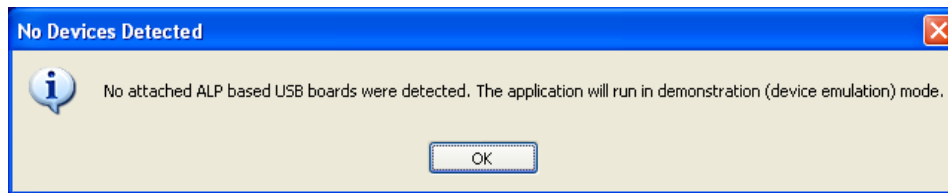

Figure 1-18. ALP No Devices Error

1. Check the device manager to make sure that the USB driver is installed. There should be a “HID-compliant device” under the “Human Interface Devices” as shown in [Figure 1-19](#).

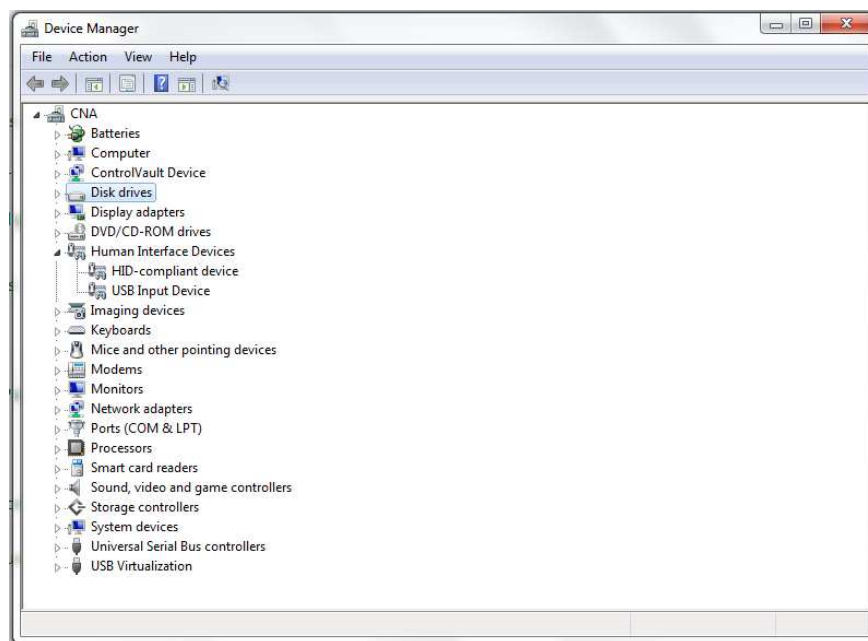

Figure 1-19. Windows 7, ALP USB Driver

2. Check to make sure the software starts with only “DS90Ux949” in the “Devices” drop-down menu. If there are more devices then the software is most likely in demo mode. When the ALP is operating in demo mode there is a “(Demo Mode)” indication in the lower left of the application status bar as shown in Figure 1-20.

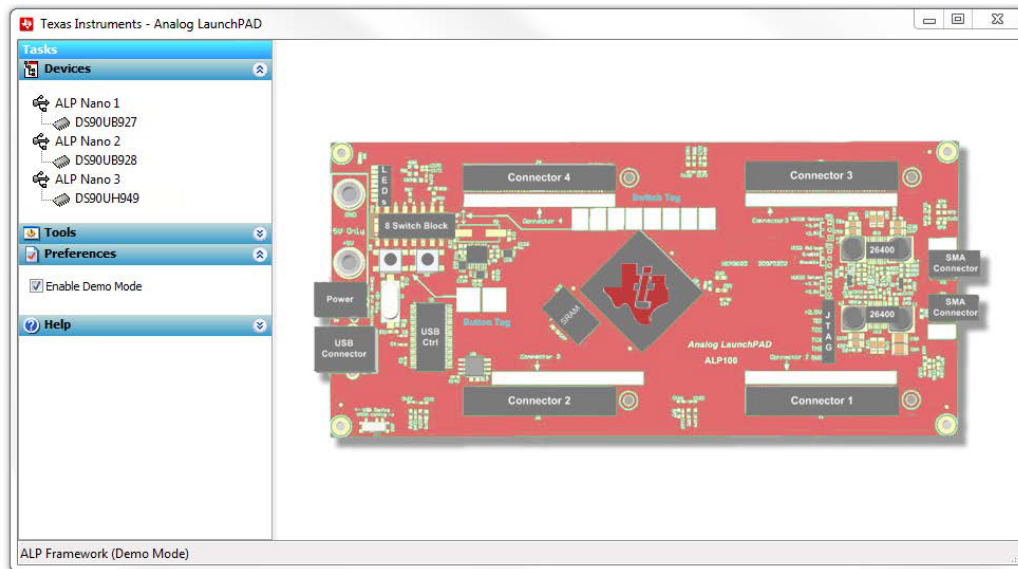

Figure 1-20. ALP in Demo Mode

3. Select the “Preferences” drop-down menu and un-check the “Enable Demo Mode” check mark to disable the demo mode.

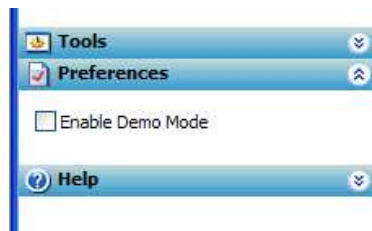

Figure 1-21. ALP Preferences Menu

After demo mode is disabled, the ALP software will poll the ALP hardware. The ALP software will update and only have “DS90UH949” or “DS90UB949” under the “Devices” drop-down menu.

1.13 Typical Connection and Test Equipment

The following is a list of typical test equipment that may be used to generate signals for the serializer inputs:

1. Digital Video Source – for generation of specific display timing such as Digital Video Processor or Graphics Controller (GPU) with HDMI or OpenLDI output.
2. Any other signal generator / video source - This video generator may be used for video signal sources for DVI or DP++
3. Any other signal / video generator that provides the correct input levels as specified in the datasheet.

Figure 1-22 shows a typical test set up using a Graphics Controller and display.

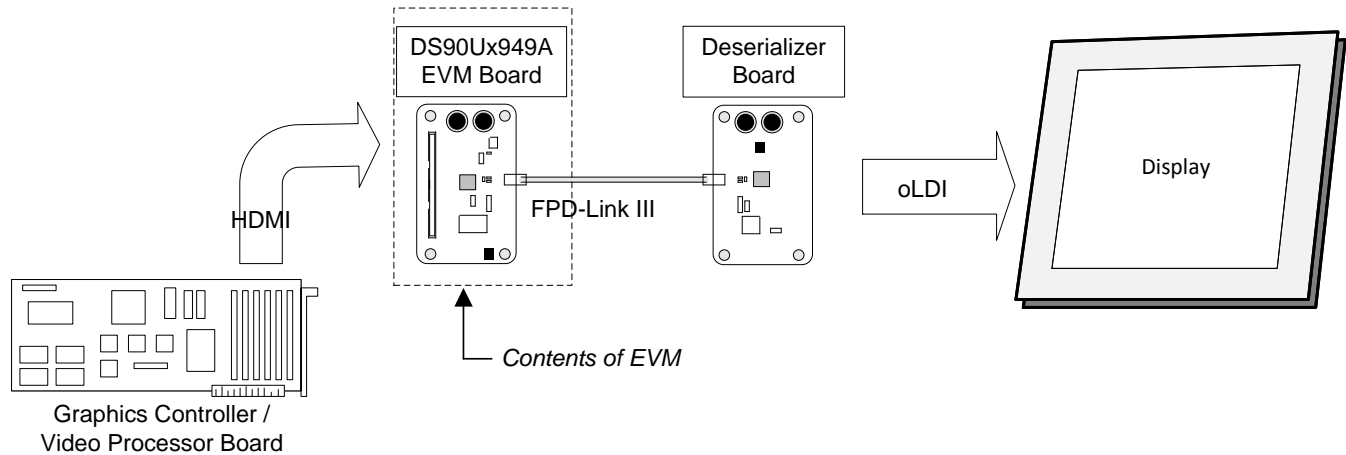

Figure 1-22. Typical Test Setup for Video Application

Figure 1-23 shows a typical test set up using a video generator and logic analyzer.

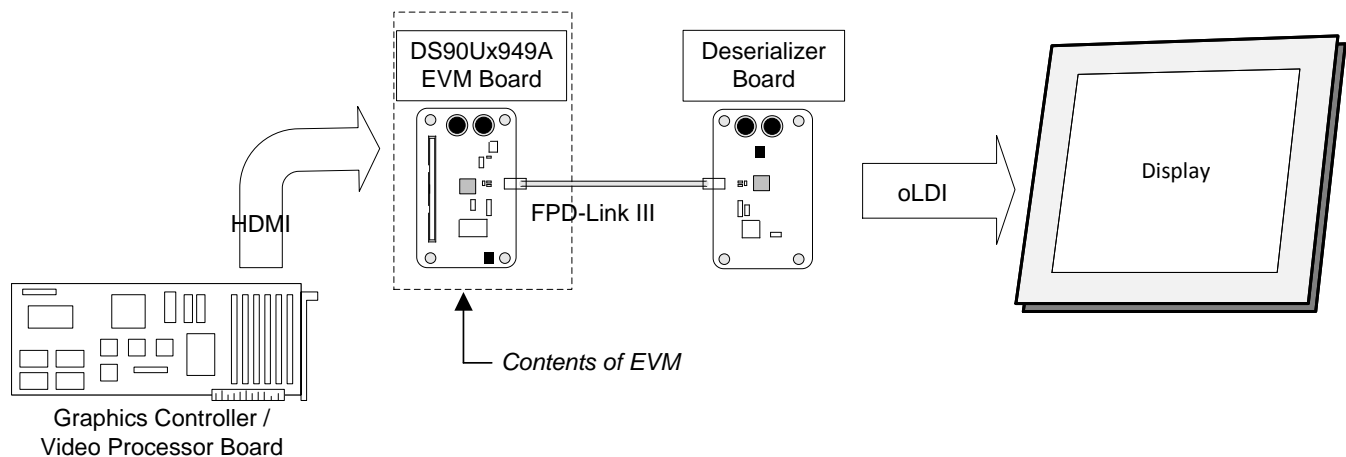

Figure 1-23. Typical Test Setup for Evaluation

1.14 Equipment References

NOTE: The following references are supplied only as a courtesy to our valued customers. It is not intended to be an endorsement of any particular equipment or supplier.

Digital Video Pattern Generator:

Astrodesign

www.astro-americas.com

Logic Analyzer:

keysight Technologies

www.keysight.com

Corelis CAS-1000-I2C/E I2C Bus Analyzer and Exerciser Products:

www.corelis.com/products/I2C-Analyzer.htm

Aardvark I2C/SPI Host Adapter Part Number: TP240141

www.totalphase.com/products/aardvark_i2cspi

1.15 Cable References

For optimal performance, TI recommends a Shielded Twisted-Pair (STP), 24 AWG (or larger diameter) cable with a 100- Ω differential impedance for high-speed data applications.

Leoni Dacar 538 series cable:

www.leoni-automotive-cables.com

Rosenberger HSD connector:

www.rosenberger.de/en/Products/35_Automotive_HSD.php

Bill of Materials

Table 2-1. Bill of Materials

Designator	Quantity	Value	Description	Package Reference	Part Number	Manufacturer
!PCB1	1		Printed Circuit Board		HSDC016	Any
C15, C24, C39	3	10pF	CAP, CERM, 10 pF, 50 V, +/- 5%, C0G/NP0, 0402	0402	GRM1555C1H10 0JA01D	MuRata
C16	1	1.8pF	CAP, CERM, 1.8 pF, 50 V, +/- 5%, C0G/NP0, 0402	0402	GRM1555C1H1 R8CA01D	MuRata
C17, C21, C26, C27, C31, C35, C38, C40, C43, C44, C46, C47, C50, C54, C55, C57, C112, C113, C114, C121, C122, C124, C125, C127, C128	25	0.1uF	CAP, CERM, 0.1 μF, 16 V, +/- 10%, X7R, 0402	0402	GRM155R71C10 4KA88D	MuRata
C18	1	100uF	CAP, TA, 100 μF, 16 V, +/- 20%, 0.1 ohm, SMD	7343-31	T495D107M016 ATE100	Kemet
C19, C58, C66, C73, C80, C89, C92	7	47uF	CAP, CERM, 47 μF, 16 V, +/- 20%, X5R, 1210	1210	GRM32ER61C4 76ME15L	MuRata
C20, C28, C41, C45, C56, C115, C123	7	10uF	CAP, CERM, 10 μF, 10 V, +/- 10%, X7R, 0805	0805	GRM21BR71A1 06KE51L	MuRata
C22	1	3300pF	CAP, CERM, 3300 pF, 50 V, +/- 10%, X7R, 0402	0402	GRM155R71H33 2KA01D	MuRata
C23	1	1uF	CAP, CERM, 1 μF, 16 V, +/- 10%, X7R, 0603	0603	C1608X7R1C10 5K080AC	TDK
C25, C32, C37, C42, C59, C67, C74, C81, C90, C93	10	4.7uF	CAP, CERM, 4.7 μF, 16 V, +/- 10%, X7R, 0805	0805	GRM21BR71C4 75KA73L	MuRata
C29	1	22uF	CAP, TA, 22 μF, 25 V, +/- 20%, 0.7 ohm, SMD	7343-31	293D226X0025D 2TE3	Vishay-Sprague
C30	1	2.2uF	CAP, TA, 2.2 μF, 25 V, +/- 10%, 6.3 ohm, SMD	3216-18	293D225X9025A 2TE3	Vishay-Sprague
C33	1	0.01uF	CAP, CERM, 0.01 μF, 100 V, +/- 5%, X7R, 0603	0603	06031C103JAT2 A	AVX

Table 2-1. Bill of Materials (continued)

Designator	Quantity	Value	Description	Package Reference	Part Number	Manufacturer
C34, C36	2	20pF	CAP, CERM, 20 pF, 50 V,+/- 5%, C0G/NP0, 0402	0402	GRM1555C1H20 0JA01D	MuRata
C48, C49, C51, C52, C53	5	4.7pF	CAP, CERM, 4.7 pF, 25 V,+/- 5%, C0G/NP0, 0402	0402	GRM1555C1E4 R7CA01D	MuRata
C60, C68, C75, C82, C94	5	10uF	CAP, CERM, 10 µF, 10 V,+/- 10%, X5R, 0805	0805	C0805C106K8P ACTU	Kemet
C61, C69, C76, C78, C83, C95, C96, C97, C98, C99, C100, C101	12	1uF	CAP, CERM, 1 µF, 16 V,+/- 10%, X5R, 0603	0603	C0603C105K4P ACTU	Kemet
C62, C63, C64, C65, C70, C71, C72, C77, C79, C84, C85, C86, C87, C88, C91	15	0.1uF	CAP, CERM, 0.1 µF, 25 V,+/- 10%, X7R, 0603	0603	06033C104KAT2 A	AVX
C104, C106, C108, C109	4	0.1uF	CAP, CERM, 0.1 µF, 50 V,+/- 10%, X7R, 0402	0402	C1005X7R1H10 4K050BB	TDK
C110	1	0.012uF	CAP, CERM, 0.012 µF, 16 V,+/- 10%, X7R, 0402	0402	GRM155R71C12 3KA01D	MuRata
C116, C120	2	220pF	CAP, CERM, 220 pF, 50 V,+/- 1%, C0G/NP0, 0603	0603	06035A221FAT2 A	AVX
C117, C118	2	30pF	CAP, CERM, 30 pF, 100 V,+/- 5%, C0G/NP0, 0603	0603	GRM1885C2A30 0JA01D	MuRata
C119	1	2200pF	CAP, CERM, 2200 pF, 50 V,+/- 10%, X7R, 0603	0603	C0603X222K5R ACTU	Kemet
C126	1	0.47uF	CAP, CERM, 0.47 µF, 16 V,+/- 10%, X7R, 0603	0603	GRM188R71C47 4KA88D	MuRata
D1	1	40V	Diode, Schottky, 40 V, 1 A, SOD-123	SOD-123	1N5819HW-7-F	Diodes Inc.
D2, D3, D5	3	Green	LED, Green, SMD	1.6x0.8x0.8mm	LTST-C190GKT	Lite-On
D4	1	Orange	LED, Orange, SMD	1.6x0.8x0.8mm	LTST-C190KFKT	Lite-On
F1	1		Fuse, 7 A, 24VAC/VDC, SMD	3.18x1.52x1.14mm	0429007.WRML	Littelfuse
H1, H2, H5, H6	4		Standoff, Hex, 0.5"L #4-40 Nylon	Standoff	1902C	Keystone
H3, H4, H7, H8	4		Machine Screw, Round, #4-40 x 1/4, Nylon, Philips panhead	Screw	NY PMS 440 0025 PH	B and F Fastener Supply

Table 2-1. Bill of Materials (continued)

Designator	Quantity	Value	Description	Package Reference	Part Number	Manufacturer
J4, J6, J7, J10, J13, J19, J21, J22, J24, J29, J30, J31, J32, J33, J35, J36, J39, J40	18		Header, 100mil, 2x1, Gold, TH	Header, 2x1, 100mil	5-146261-1	TE Connectivity
J5, J9, J11, J12, J20, J23, J41, J42	8		Header, 100mil, 3x1, Gold, TH	3x1 Header	TSW-103-07-G-S	Samtec
J8	1		Connector, DC Jack 2.1X5.5 mm, TH	POWER JACK, 14.4x11x9mm	PJ-102A	CUI Inc.
J14, J15, J16, J17	4		Connector, End launch SMA, 50 ohm, SMT	SMA End Launch	142-0701-851	Cinch Connectivity
J18	1		Connector, HDMI, 19-Pos Recept, SMT	15.0x6.08x11.55 mm	1747981-1	TE Connectivity
J25, J27	2		Header (friction lock), 100mil, 4x1, Gold, TH	Header 4x1 keyed	0022112042	Molex
J26	1		Header, 100mil, 16x2, Gold, TH	16x2 Header	TSW-116-07-G-D	Samtec
J28	1		Header, 100mil, 4x1, Gold, TH	4x1 Header	TSW-104-07-G-S	Samtec
J34	1		Connector, Receptacle, Mini-USB Type B, R/A, Top Mount SMT	USB Mini Type B	1734035-2	TE Connectivity
L3	1	4.7uH	Inductor, Shielded Drum Core, Ferrite, 4.7 uH, 4.2 A, 0.02 ohm, SMD	WE-TPC-XLH2	7440650047	Wurth Elektronik
L4, L5	2		Coupled inductor, 0.22 A, 0.59 ohm, SMD	Inductor, 1.2x1.2x2.0 mm	DLW21SN261X Q2L	MuRata
L6, L9	2	1000 ohm	Ferrite Bead, 1000 ohm @ 100 MHz, 0.3 A, 0805	0805	BK2125HS102-T	Taiyo Yuden
L7, L8, L10	3	120 ohm	Ferrite Bead, 120 ohm @ 100 MHz, 3 A, 0603	0603	BLM18SG121TN 1D	MuRata
L12	1	330 ohm	Ferrite Bead, 330 ohm @ 100 MHz, 1.5 A, 0603	0603	BLM18SG331TN 1D	MuRata
P1	1		Right Angle Plug for PCB, TH	HSD connector, Waterblue	D4S20G-400A5-Z	Rosenberger
Q1, Q2, Q3, Q4	4	50V	MOSFET, N-CH, 50 V, 0.22 A, SOT-23	SOT-23	BSS138	Fairchild Semiconductor
R11	1	121k	RES, 121 k, 1%, 0.063 W, 0402	0402	CRCW0402121K FKED	Vishay-Dale
R12	1	22.1k	RES, 22.1 k, 1%, 0.063 W, 0402	0402	CRCW040222K1 FKED	Vishay-Dale
R13, R17, R26, R29	4	0	RES, 0, 5%, 0.1 W, 0603	0603	CRCW06030000 Z0EA	Vishay-Dale

Table 2-1. Bill of Materials (continued)

Designator	Quantity	Value	Description	Package Reference	Part Number	Manufacturer
R14, R18, R22, R27	4	100k	RES, 100 k, 5%, 0.063 W, 0402	0402	CRCW0402100K JNED	Vishay-Dale
R15, R42, R45, R119, R120, R121, R174, R178	8	10.0k	RES, 10.0 k, 1%, 0.063 W, 0402	0402	CRCW040210K0 FKED	Vishay-Dale
R16	1	3.24k	RES, 3.24 k, 1%, 0.063 W, 0402	0402	CRCW04023K24 FKED	Vishay-Dale
R19	1	1.87k	RES, 1.87 k, 1%, 0.063 W, 0402	0402	CRCW04021K87 FKED	Vishay-Dale
R20, R24, R28, R33, R34, R36, R37, R38, R39, R40, R41, R43, R44, R48, R49, R50, R51, R52, R53, R54, R55, R56, R57, R60, R61, R63, R122, R123, R127, R128, R130, R132, R133, R138, R142, R144, R145, R146, R147, R148, R149, R150, R152, R153, R154, R155, R156, R157, R158, R159, R160, R162, R163, R165	54	0	RES, 0, 5%, 0.063 W, 0402	0402	ERJ-2GE0R00X	Panasonic
R21	1	4.99k	RES, 4.99 k, 1%, 0.063 W, 0402	0402	CRCW04024K99 FKED	Vishay-Dale
R23	1	23.2k	RES, 23.2 k, 1%, 0.063 W, 0402	0402	CRCW040223K2 FKED	Vishay-Dale
R25	1	12.1k	RES, 12.1 k, 1%, 0.063 W, 0402	0402	CRCW040212K1 FKED	Vishay-Dale
R30, R31, R32	3	470	RES, 470, 5%, 0.063 W, 0402	0402	CRCW0402470 RJNED	Vishay-Dale
R35	1	1.0k	RES, 1.0 k, 5%, 0.063 W, 0402	0402	CRCW04021K00 JNED	Vishay-Dale
R46, R47, R151	3	4.7k	RES, 4.7 k, 5%, 0.063 W, 0402	0402	CRCW04024K70 JNED	Vishay-Dale
R58, R59	2	47k	RES, 47 k, 5%, 0.063 W, 0402	0402	CRCW040247K0 JNED	Vishay-Dale
R62	1	27k	RES, 27 k, 5%, 0.063 W, 0402	0402	CRCW040227K0 JNED	Vishay-Dale
R65, R74, R101	3	118k	RES, 118 k, 1%, 0.063 W, 0402	0402	CRCW0402118K FKED	Vishay-Dale
R66, R75, R102	3	107k	RES, 107 k, 1%, 0.063 W, 0402	0402	CRCW0402107K FKED	Vishay-Dale
R67, R76, R103	3	113k	RES, 113 k, 1%, 0.063 W, 0402	0402	CRCW0402113K FKED	Vishay-Dale
R68, R77, R104	3	82.5k	RES, 82.5 k, 1%, 0.063 W, AEC-Q200 Grade 0, 0402	0402	CRCW040282K5 FKED	Vishay-Dale

Table 2-1. Bill of Materials (continued)

Designator	Quantity	Value	Description	Package Reference	Part Number	Manufacturer
R69, R78, R105	3	68.1k	RES, 68.1 k, 1%, 0.063 W, 0402	0402	CRCW040268K1FKED	Vishay-Dale
R70, R79, R106	3	56.2k	RES, 56.2 k, 1%, 0.063 W, 0402	0402	CRCW040256K2FKED	Vishay-Dale
R71, R80, R107	3	13.3k	RES, 13.3 k, 1%, 0.063 W, 0402	0402	CRCW040213K3FKED	Vishay-Dale
R82, R91, R109	3	40.2k	RES, 40.2 k, 1%, 0.063 W, 0402	0402	CRCW040240K2FKED	Vishay-Dale
R83, R92, R110	3	30.9k	RES, 30.9 k, 1%, 0.063 W, 0402	0402	CRCW040230K9FKED	Vishay-Dale
R84, R93, R111	3	51.1k	RES, 51.1 k, 1%, 0.063 W, 0402	0402	CRCW040251K1FKED	Vishay-Dale
R85, R94, R112	3	88.7k	RES, 88.7 k, 1%, 0.063 W, 0402	0402	CRCW040288K7FKED	Vishay-Dale
R86, R95, R113	3	102k	RES, 102 k, 1%, 0.063 W, 0402	0402	CRCW0402102KFKED	Vishay-Dale
R87, R96, R114	3	137k	RES, 137 k, 1%, 0.063 W, 0402	0402	CRCW0402137KFKED	Vishay-Dale
R88, R97, R115	3	210k	RES, 210 k, 1%, 0.063 W, 0402	0402	CRCW0402210KFKED	Vishay-Dale
R118	1	1.00k	RES, 1.00 k, 1%, 0.1 W, 0402	0402	ERJ-2RKF1001X	Panasonic
R161	1	49.9	RES, 49.9, 1%, 0.063 W, 0402	0402	CRCW040249R9FKED	Vishay-Dale
R170, R171	2	33	RES, 33, 5%, 0.063 W, 0402	0402	CRCW040233R0JNED	Vishay-Dale
R172, R179, R180	3	1.5k	RES, 1.5 k, 5%, 0.063 W, 0402	0402	CRCW04021K50JNED	Vishay-Dale
R173, R176	2	33k	RES, 33 k, 5%, 0.063 W, 0402	0402	CRCW040233K0JNED	Vishay-Dale
R175	1	1.2Meg	RES, 1.2 M, 5%, 0.1 W, 0603	0603	CRCW06031M20JNEA	Vishay-Dale
R177	1	200	RES, 200, 5%, 0.063 W, 0402	0402	CRCW0402200RJNED	Vishay-Dale
S2, S3, S6	3		Switch, Slide, SPST 8 poles, SMT	Switch, 8Pos, 21.8x3.8x6.7 mm	219-8MST	CTS Electrocomponents
S4, S7, S8	3		SWITCH TACTILE SPST-NO 0.02A 15V, TH	6x4.3x6mm	EVQ-PAD04M	Panasonic
			'Tactile Switch Through-hole-mounting Switches	SW_TACT	B3F-1000	OMRON
S5	1		DIP Switch, 4 position slide actuator, SPST, SMD	SMT DIP switch	A6S-4104-H	Omron Electronic Components
SH-J1, SH-J2, SH-J4, SH-J5, SH-J6, SH-J7, SH-J8	7	1x2	Shunt, 2mm, Gold plated, Black	2mm Shunt, Closed Top	2SN-BK-G	Samtec
TP2, TP5, TP11	3		Terminal, Turret, TH, Double	Keystone1502-2	1502-2	Keystone

Table 2-1. Bill of Materials (continued)

Designator	Quantity	Value	Description	Package Reference	Part Number	Manufacturer
U2	1		4.5V to 18V Input, 2A Synchronous Step-Down Converter, PWP0014E (TSSOP-14)	PWP0014E	TPS54225PWP R	Texas Instruments
U3	1		Single Output LDO, 500 mA, Adjustable 0.8 to 3.6 V Output, 0.8 to 5.5 V Input, with Programmable Soft Start, 10-pin SON (DRC), -40 to 125 degC, Green (RoHS and no Sb/Br)	DRC0010J	TPS74701DRCR	Texas Instruments
U4	1		Dual Output LDO, 1 A, Fixed 1.8, 3.3 V Output, 2.7 to 10 V Input, 28-pin HTSSOP (PWP), -40 to 125 degC, Green (RoHS and no Sb/Br)	PWP0028D	TPS767D318PW P	Texas Instruments
U5	1		Socket, DIP-8, Sleeve Pin, 2.54 mm Pitch	DIP-8, Body 10.16x10.16mm, Pitch 2.54mm	110-13-308-41-001000	Mill-Max
U6	1		Automotive 210MHz HDMI to FPD-Link III Bridge Serializer with HDCP, RGC0064K (VQFN-64)	RGC0064K	DS90UH949ATR GCRQ1 for Variant -001	Texas Instruments
			Automotive 210MHz HDMI to FPD-Link III Bridge Serializer, RGC0064K (VQFN-64)		DS90UB949ATR GCRQ1 for Variant -002	
U8	1		6-Bit Bidirectional Voltage-Level Translator with Auto Direction Sensing and +/- 15-kV ESD Protect, PW0016A (TSSOP-16)	PW0016A	TXB0106PWR	Texas Instruments
U9	1		ESD-Protection Array for High-Speed Data Interfaces, 4 Channels, -40 to +85 degC, 6-pin SON (DRY), Green (RoHS and no Sb/Br)	DRY0006A	TPD4E004DRY RG4	Texas Instruments

Table 2-1. Bill of Materials (continued)

Designator	Quantity	Value	Description	Package Reference	Part Number	Manufacturer
U10	1		16-Bit Ultra-Low-Power Microcontroller, 128KB Flash, 8KB RAM, USB, 12Bit ADC, 2 USCIs, 32Bit HW MPY, PN0080A (LQFP-80)	PN0080A	MSP430F5529IPN	Texas Instruments
U11	1		TCA9406 Dual Bidirectional 1-MHz I2C-BUS and SMBus Voltage Level-Translator, 1.65 to 3.6 V, -40 to 85 degC, 8-pin US8 (DCU), Green (RoHS and no Sb/Br)	DCU0008A	TCA9406DCUR	Texas Instruments
Y4	1		Crystal, 24.000 MHz, 20pF, SMD	Crystal, 11.4x4.3x3.8mm	ECS-240-20-5PX-TR	ECS Inc.
C1, C9	0	0.01uF	CAP, CERM, 0.01 μ F, 100 V, +/- 5%, X7R, 0603	0603	06031C103JAT2A	AVX
C2, C5, C6, C10, C11, C13	0	10uF	CAP, CERM, 10 μ F, 10 V, +/- 10%, X7R, 0805	0805	GRM21BR71A106KE51L	MuRata
C3, C7, C12, C14	0	0.1uF	CAP, CERM, 0.1 μ F, 16 V, +/- 10%, X7R, 0402	0402	GRM155R71C104KA88D	MuRata
C4, C8	0	1uF	CAP, TA, 1 μ F, 16 V, +/- 10%, 9.3 ohm, SMD	3216-18	293D105X9016A2TE3	Vishay-Sprague
C102	0	4.7uF	CAP, CERM, 4.7 μ F, 16 V, +/- 10%, X7R, 0805	0805	GRM21BR71C475KA73L	MuRata
C103, C105, C107	0	0.1uF	CAP, CERM, 0.1 μ F, 25 V, +/- 5%, X7R, 0603	0603	C0603C104J3RAC	Kemet
C111, C130	0	0.012uF	CAP, CERM, 0.012 μ F, 16 V, +/- 10%, X7R, 0402	0402	GRM155R71C123KA01D	MuRata
C129	0	22uF	CAP, TA, 22 μ F, 25 V, +/- 20%, 0.7 ohm, SMD	7343-31	293D226X0025D2TE3	Vishay-Sprague
FID1, FID2, FID3, FID4, FID5, FID6	0		Fiducial mark. There is nothing to buy or mount.	N/A	N/A	N/A
J1	0		Audio Jack, 3.5mm, Stereo, R/A, SMT	Audio Jack SMD	SJ-3523-SMT	CUI Inc.
J2, J37, J38	0		Header, 100mil, 2x1, Gold, TH	Header, 2x1, 100mil	5-146261-1	TE Connectivity
J3	0		Header, 100mil, 3x1, Gold, TH	3x1 Header	TSW-103-07-G-S	Samtec

Table 2-1. Bill of Materials (continued)

Designator	Quantity	Value	Description	Package Reference	Part Number	Manufacturer
L1, L2	0	330 ohm	Ferrite Bead, 330 ohm @ 100 MHz, 1.5 A, 0603	0603	BLM18SG331TN 1D	MuRata
L11	0	1000 ohm	Ferrite Bead, 1000 ohm @ 100 MHz, 0.35 A, 0402	0402	BLM15AX102SN 1D	MuRata
R1, R2	0	100	RES, 100, 1%, 0.063 W, 0402	0402	CRCW0402100 FKED	Vishay-Dale
R3, R7, R8, R10, R64, R72, R73, R81, R89, R90, R98, R99, R100, R108, R116, R117, R129, R131, R139, R141, R164, R166, R167, R168, R169, R186, R187	0	0	RES, 0, 5%, 0.063 W, 0402	0402	ERJ-2GE0R00X	Panasonic
R4, R5, R6, R9	0	10.0k	RES, 10.0 k, 1%, 0.063 W, 0402	0402	CRCW040210K0 FKED	Vishay-Dale
R124, R135, R136, R140, R181	0	10k	RES, 10 k, 5%, 0.1 W, 0603	0603	CRCW060310K0 JNEA	Vishay-Dale
R125, R126, R134, R137, R143, R183, R184	0	0	RES, 0, 5%, 0.1 W, 0603	0603	CRCW06030000 Z0EA	Vishay-Dale
R182	0	3.24k	RES, 3.24 k, 1%, 0.063 W, 0402	0402	CRCW04023K24 FKED	Vishay-Dale
R185	0	0.51	RES, 0.51, 1%, 0.1 W, AEC- Q200 Grade 1, 0603	0603	ERJ-3RQFR51V	Panasonic
R188	0	2.00k	RES, 2.00 k, 1%, 0.063 W, 0402	0402	CRCW04022K00 FKED	Vishay-Dale
R189, R190	0	49.9	RES, 49.9, 1%, 0.063 W, 0402	0402	CRCW040249R 9FKED	Vishay-Dale
R191	0	1.30k	RES, 1.30 k, 1%, 0.063 W, 0402	0402	CRCW04021K30 FKED	Vishay-Dale
S1	0		Switch, Slide, SPST 3 poles, SMT	3 poles SPST Switch	219-3LPST	CTS Electrocompone nts
SH-J3	0	1x2	Shunt, 2mm, Gold plated, Black	2mm Shunt, Closed Top	2SN-BK-G	Samtec
U1	0		99dB SNR Stereo ADC with Single-Ended Inputs, PW0014A (TSSOP-14)	PW0014A	PCM1808PWR	Texas Instruments
U7	0		Single High Speed Differential Driver, 8-pin Narrow SOIC, Pb-Free	D0008A		Texas Instruments

Table 2-1. Bill of Materials (continued)

Designator	Quantity	Value	Description	Package Reference	Part Number	Manufacturer
U12	0		Single Output Automotive LDO, 750 mA, Fixed 5 V Output, 6 to 26 V Input, 5-pin PFM (KVU), -40 to 125 degC, Green (RoHS and no Sb/Br)	KVU0005A	TL751M05QKVU RQ1	Texas Instruments
Y1	0		OSC, 12.288 MHz, 3.3 Vdc, SMD	14x9.8x4.7mm	ECS-8FA3X-122.8-TR	ECS Inc.
Y2	0		OSC, 96 MHz, 3.3 Vdc, SMD	SMD, 4-Leads, Body 7x5mm	FXO-HC736R-96	Fox Electronics
Y3	0		OSC, 148.5 MHz, LVDS, 3.3 V, SMD	7x5mm	FVXO-LC73BR-148.5	IDT

EVM PCB Schematics

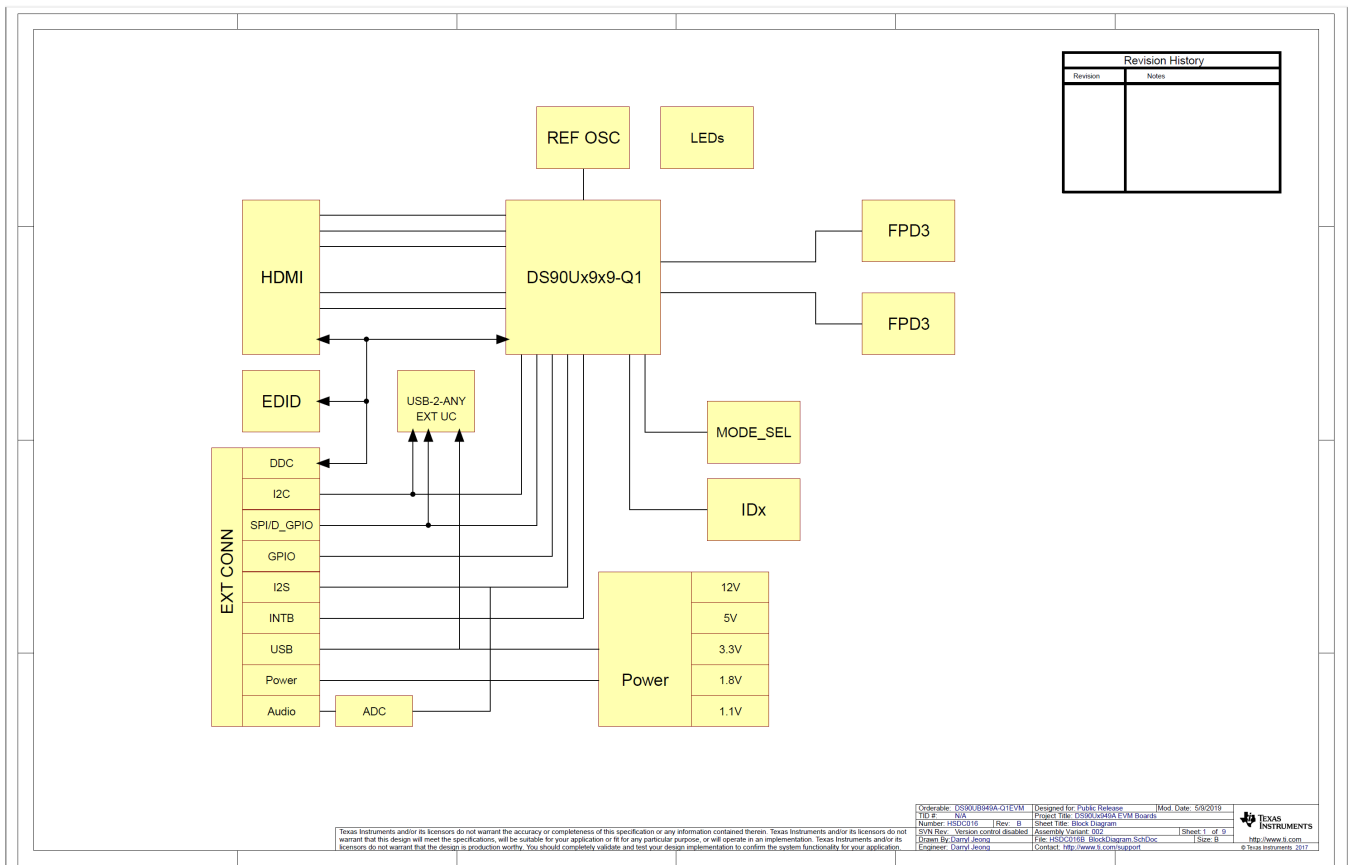

Figure A-1. Schematic - Block Diagram

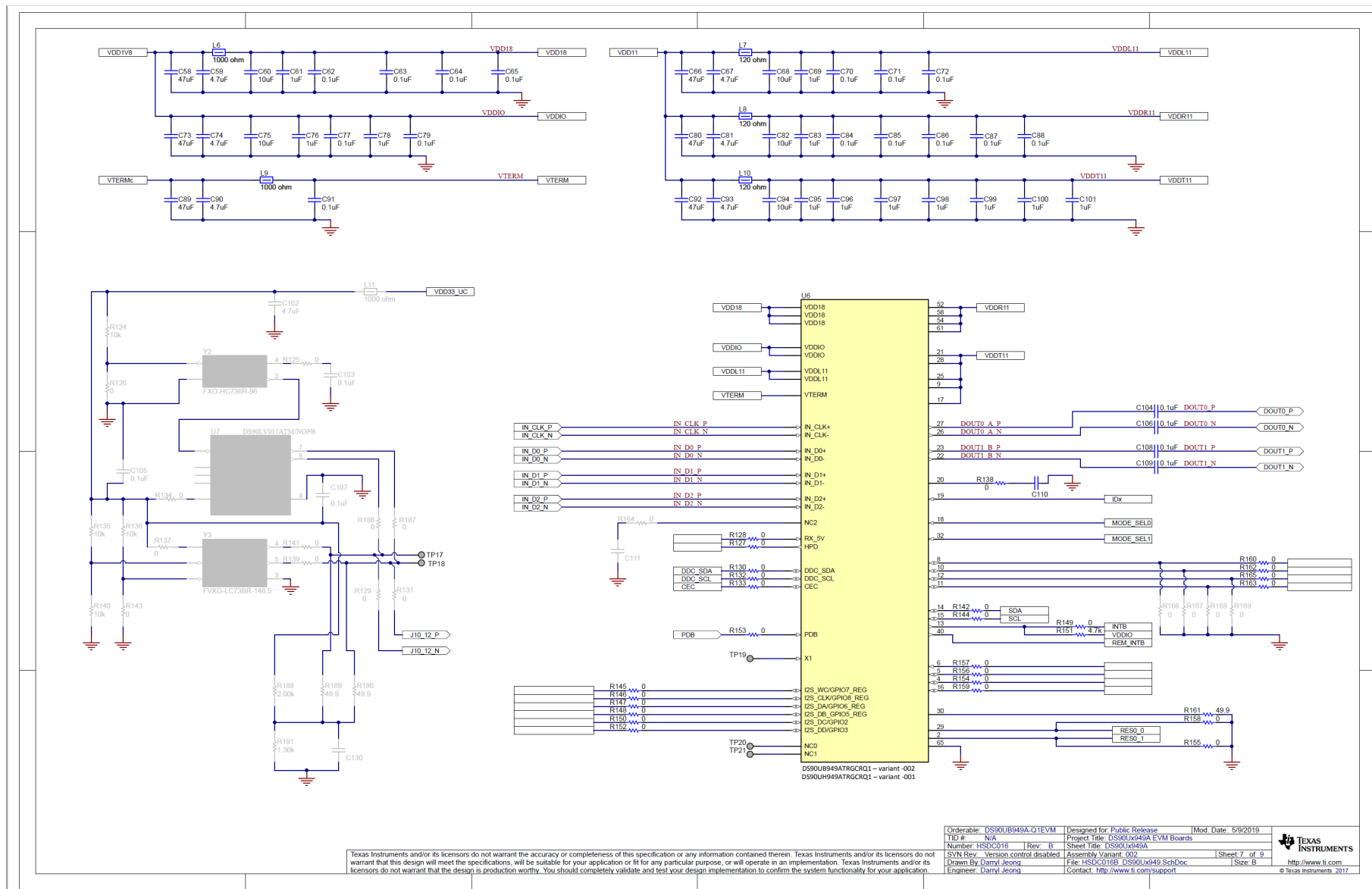

Figure A-2. Schematic - DS90UH949A-Q1 and Power Decoupling

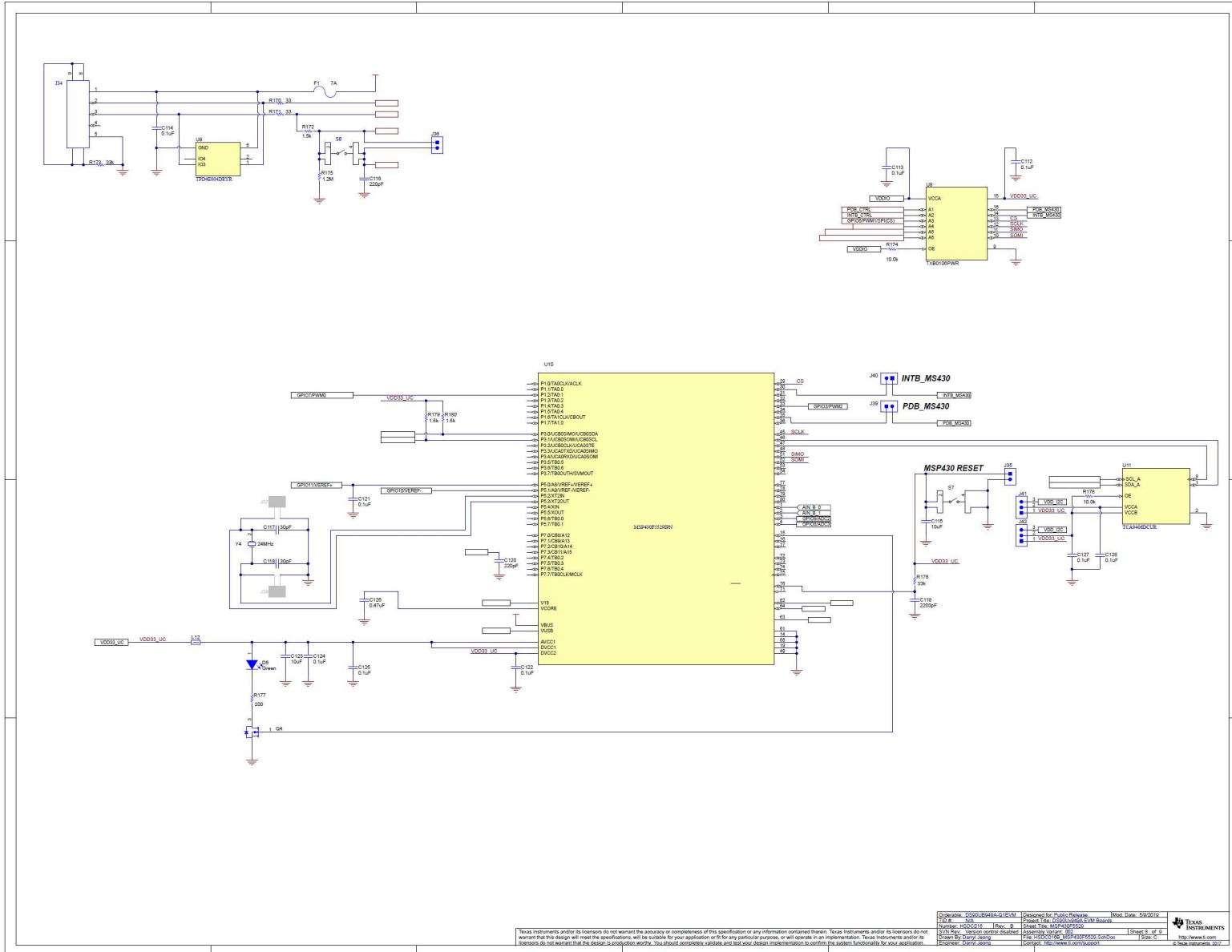

Figure A-3. Schematic - MSP430

Copyright © 2018–2019, Texas Instruments Incorporated. All rights reserved. This document is the property of Texas Instruments and is intended for use only in the context of the specific application and product described herein. This document is confidential and its contents should not be disseminated to third parties without the express written permission of Texas Instruments. The information contained herein is confidential and its disclosure to third parties without the express written permission of Texas Instruments is strictly prohibited. This document is the property of Texas Instruments and is intended for use only in the context of the specific application and product described herein. This document is confidential and its contents should not be disseminated to third parties without the express written permission of Texas Instruments. The information contained herein is confidential and its disclosure to third parties without the express written permission of Texas Instruments is strictly prohibited.

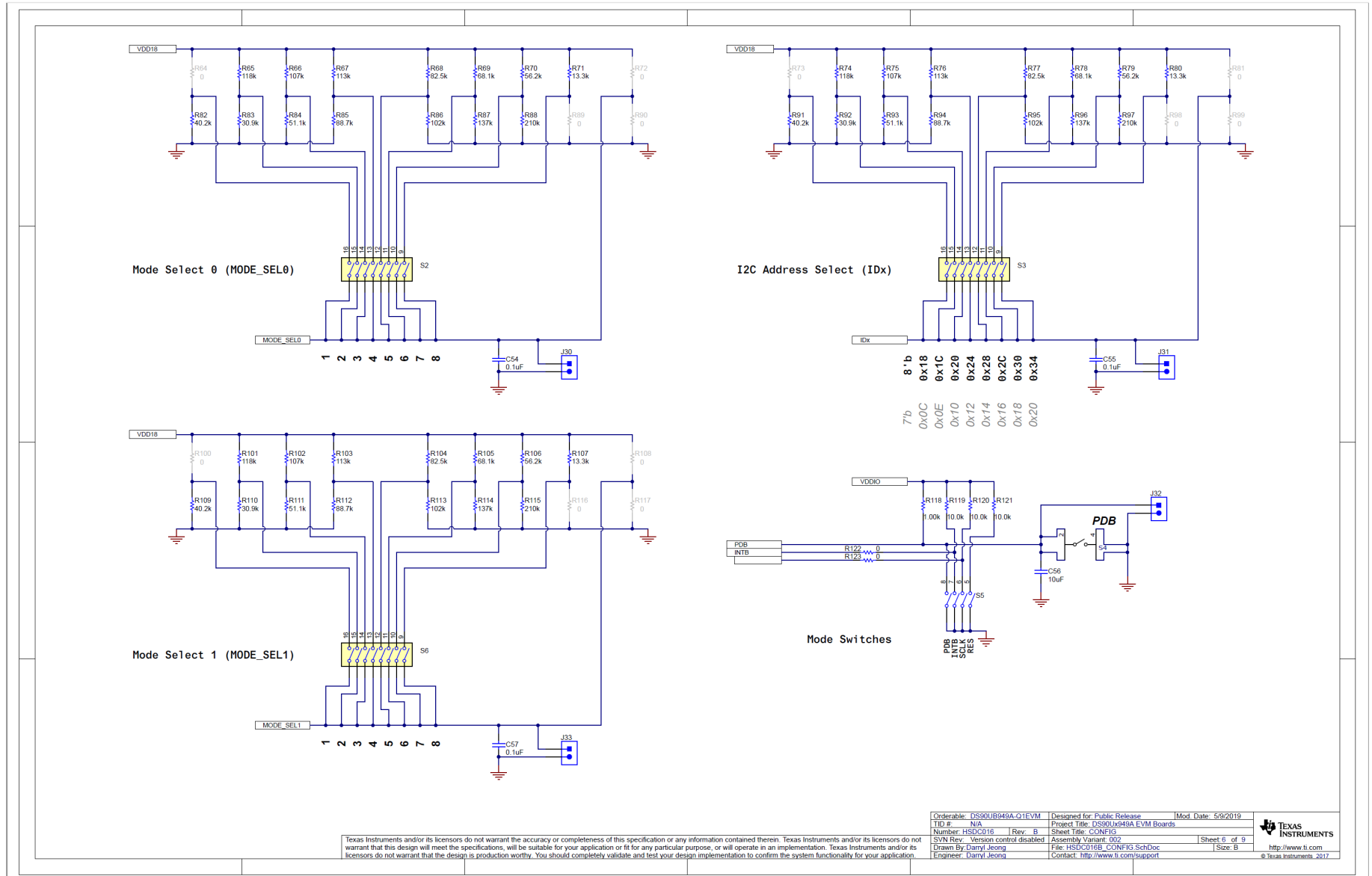

Figure A-4. Schematic - PDB, IDx and MODE_SEL Switches

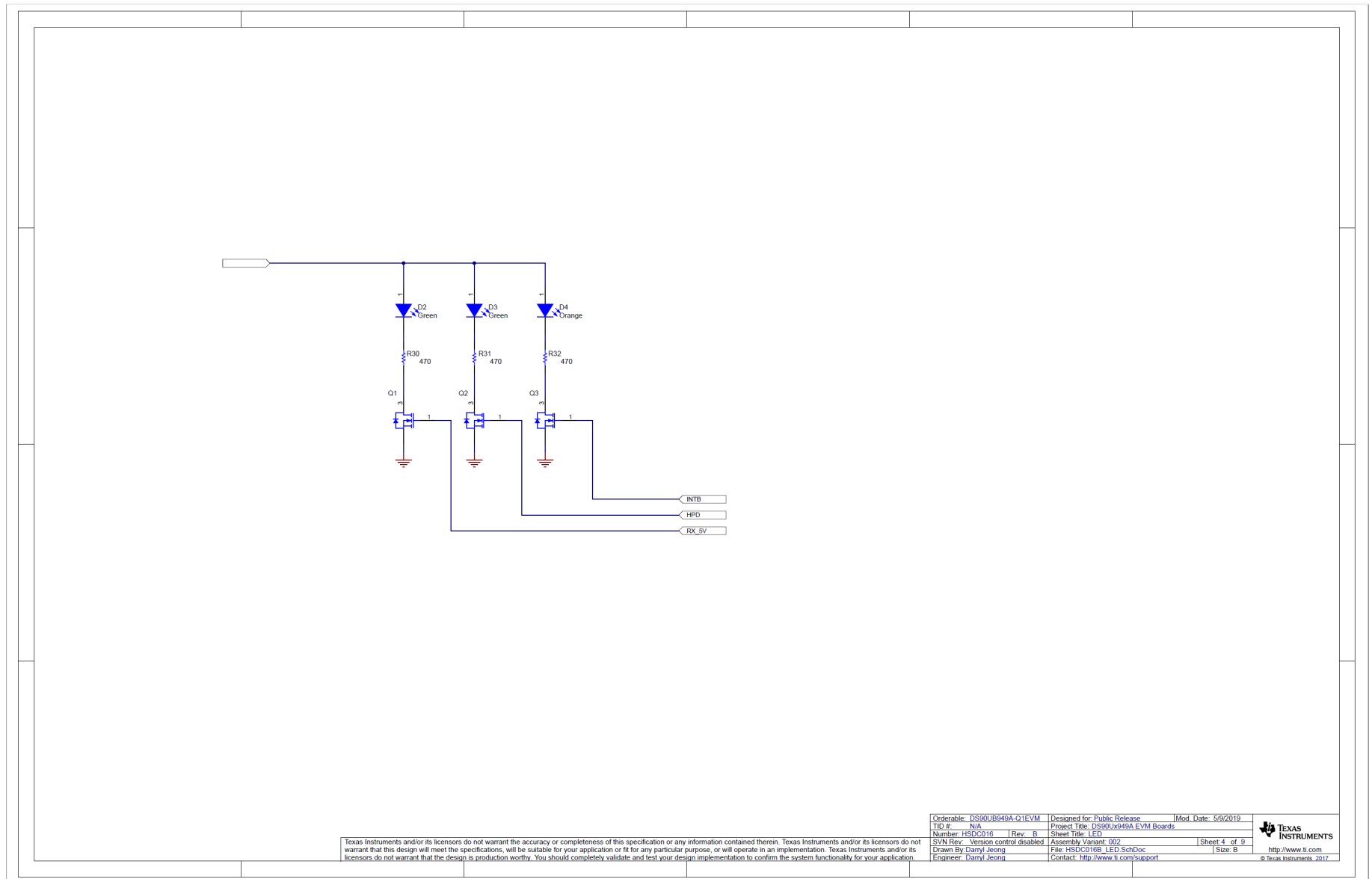
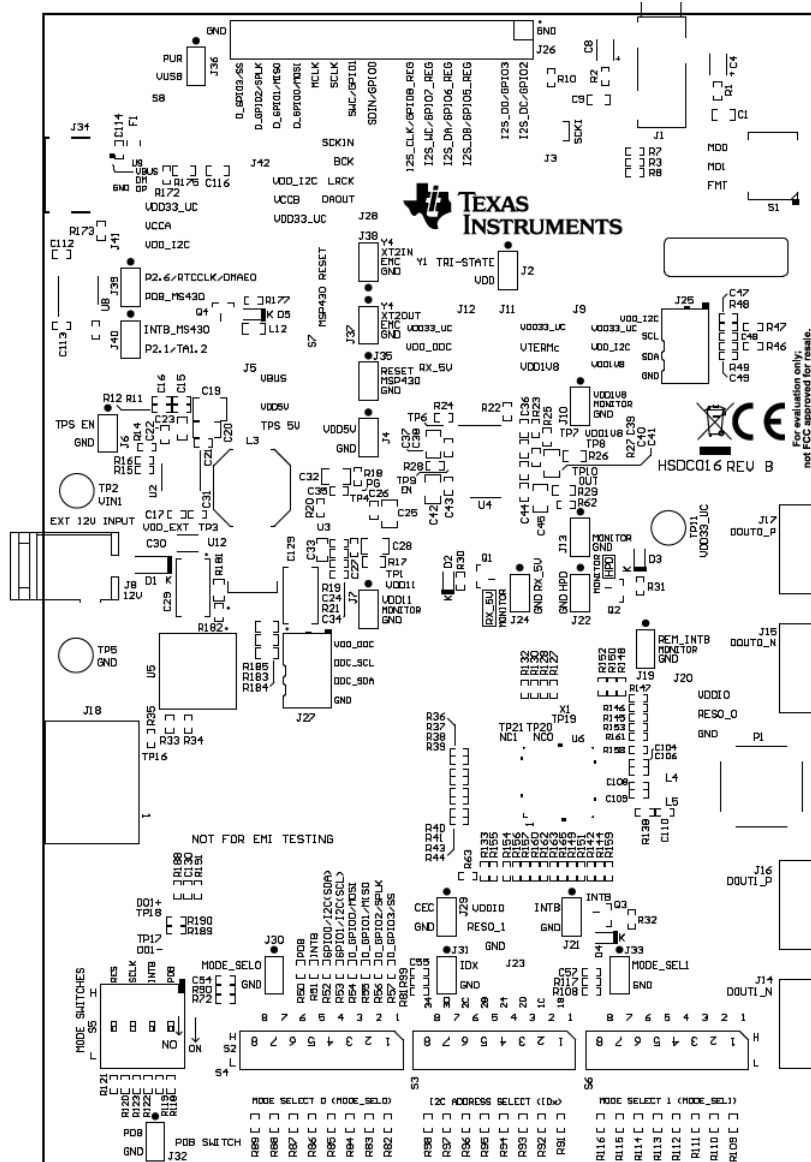

Figure A-6. Schematic - LEDs

Board Layout

Board Layers



ALL ARTWORK VIEWED FROM TOP SIDE	BOARD #: HSDC016	REV: B	SUN REV: Not In VersionControl
LAYER NAME = Top Overlay	TID #: N/A		
GENERATED : 5/15/2019 6:56:48 PM		TEXAS INSTRUMENTS	

Figure B-1. Board Layer - Top Overlay

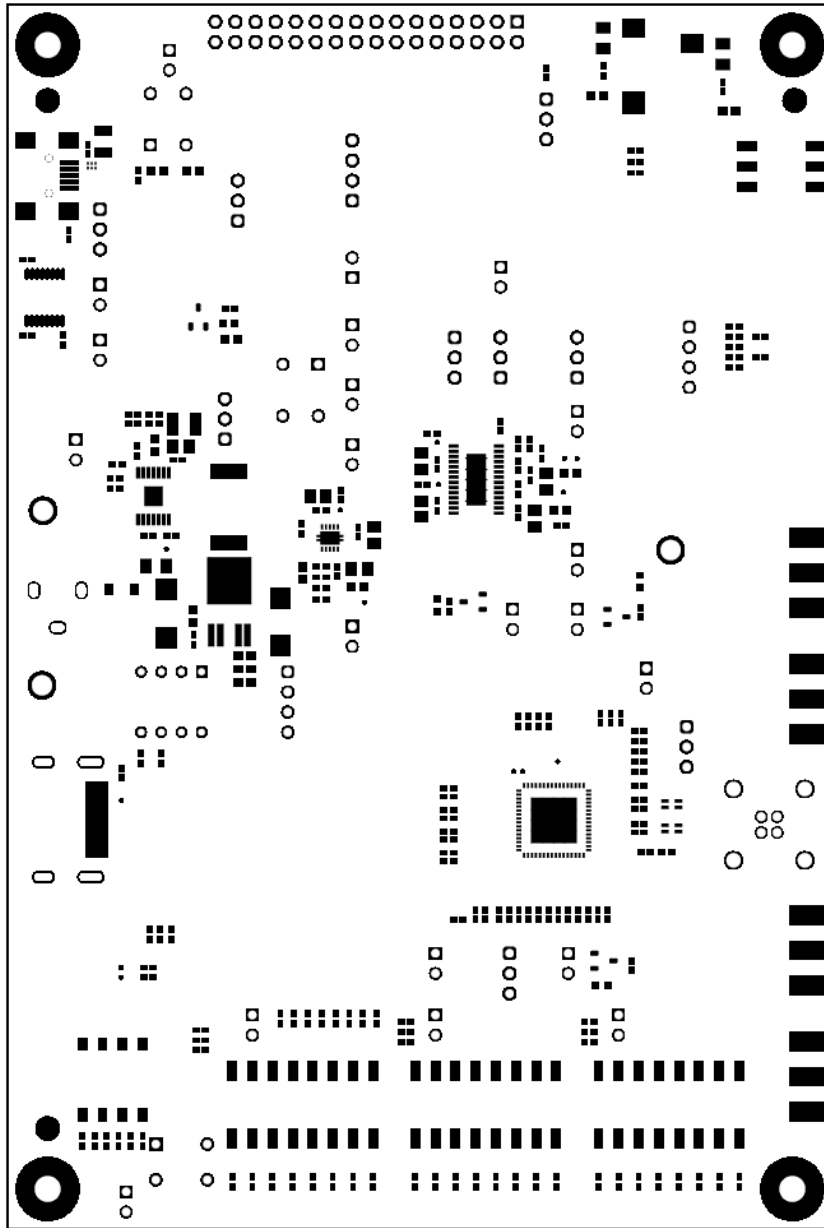

ALL ARTWORK VIEWED FROM TOP SIDE	BOARD #: HSDC016	REV: B	SUN REV: Not In VersionControl
LAYER NAME = Top Solder	TID #: N/A		
	GENERATED : 5/15/2019	6:56:51 PM	TEXAS INSTRUMENTS

Figure B-2. Board Layer - Top Solder

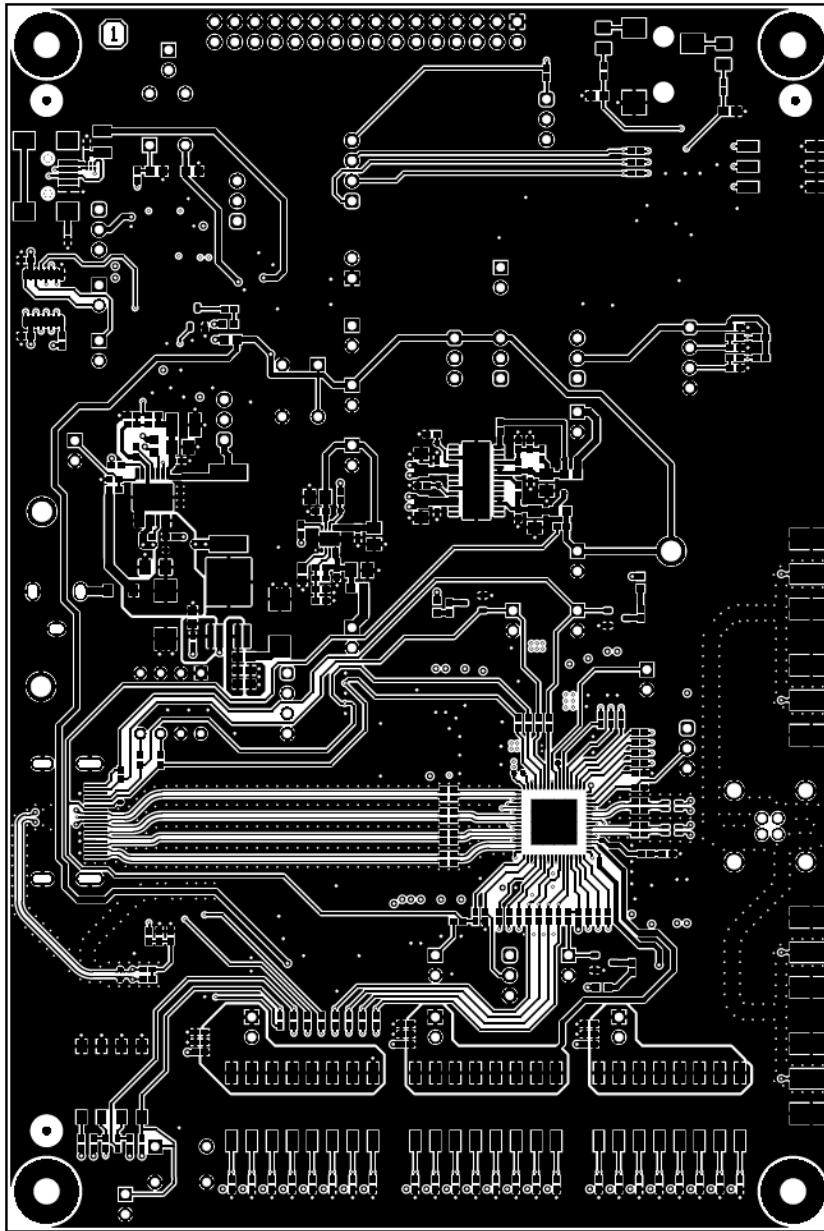

ALL ARTWORK VIEWED FROM TOP SIDE	BOARD #: HSDC016	REV: B	SVN REV: Not In VersionControl
LAYER NAME = Top Layer	TID #: N/A		
	GENERATED : 5/15/2019	6:56:53 PM	TEXAS INSTRUMENTS

Figure B-3. Board Layer - Top

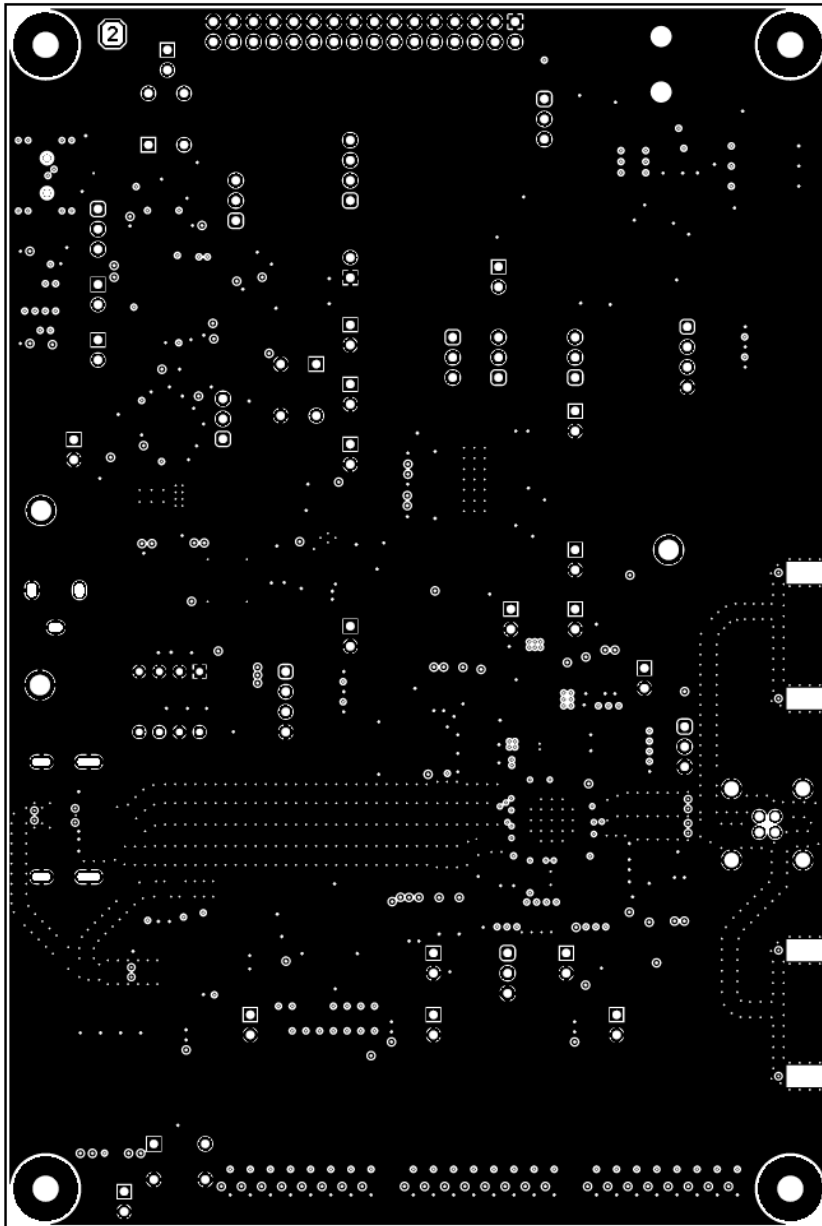

ALL ARTWORK VIEWED FROM TOP SIDE	BOARD #: HSDC016	REV: B	SUN REV: Not In VersionControl
LAYER NAME = GND	TID #: N/A		
	GENERATED : 5/15/2019 6:56:56 PM	TEXAS INSTRUMENTS	

Figure B-4. Board Layer - Ground-1

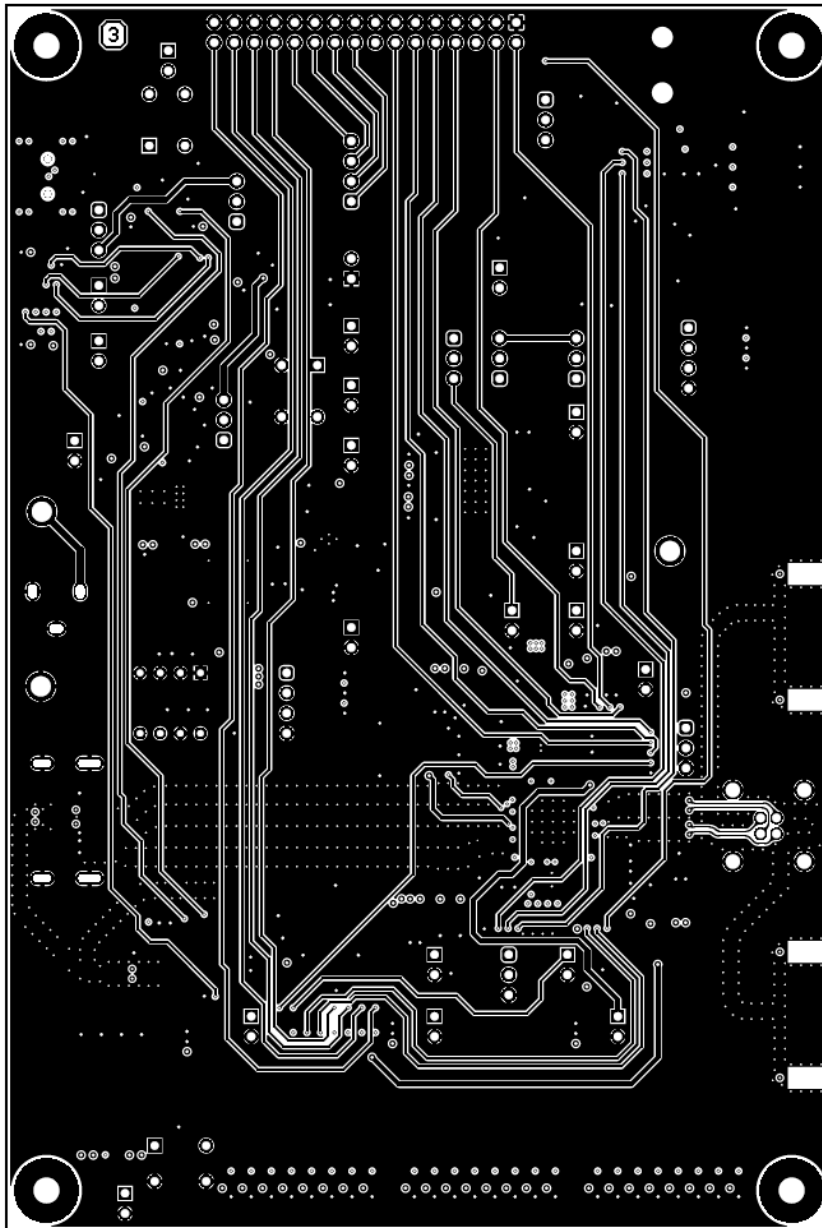

ALL ARTWORK VIEWED FROM TOP SIDE	BOARD #: HSDC016	REV: B	SUN REV: Not In VersionControl
LAYER NAME = Signal Layer	TID #: N/A		
	GENERATED : 5/15/2019	6:56:58 PM	TEXAS INSTRUMENTS

Figure B-5. Board Layer - Signal Layer

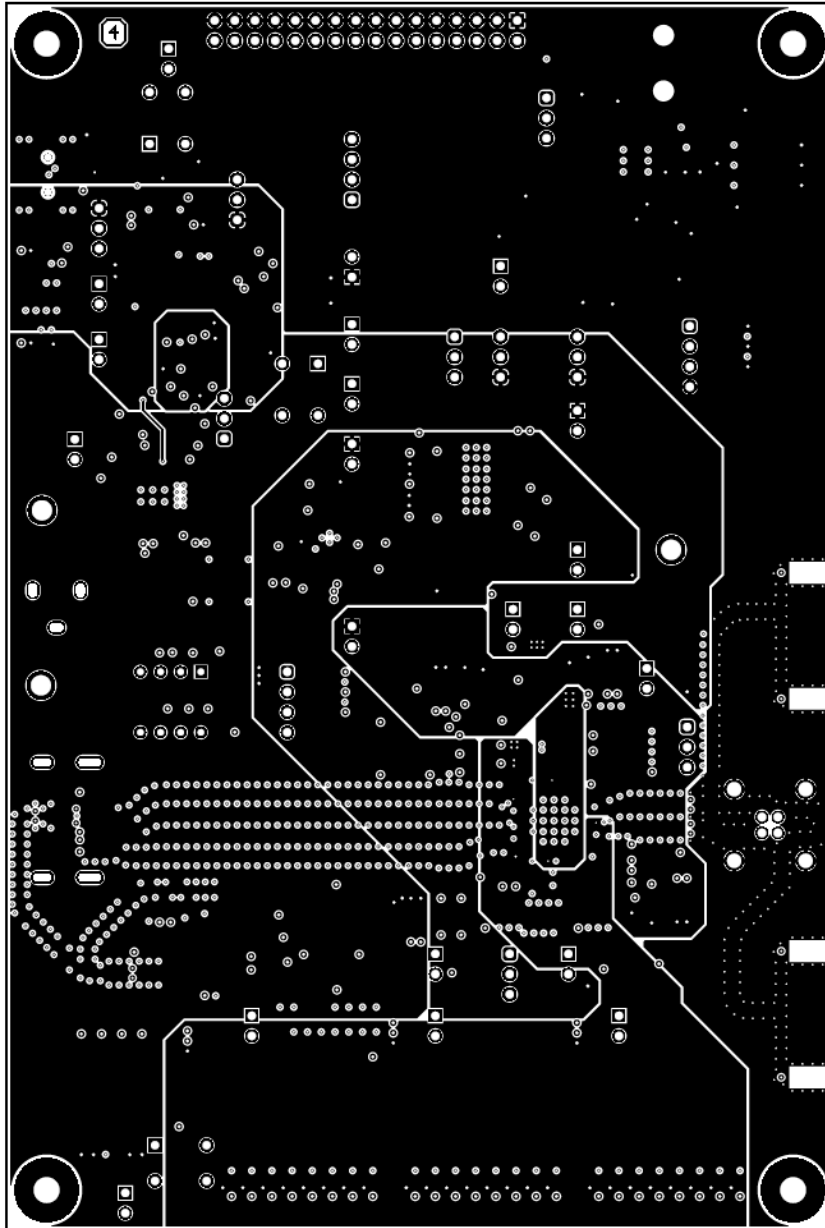

ALL ARTWORK VIEWED FROM TOP SIDE	BOARD #: HSDC016	REV: B	SUN REV: Not In VersionControl
LAYER NAME = PWR Split/GND	TID #: N/A		
	GENERATED : 5/15/2019	6:57:00 PM	TEXAS INSTRUMENTS

Figure B-6. Board Layer - Power Split/GND

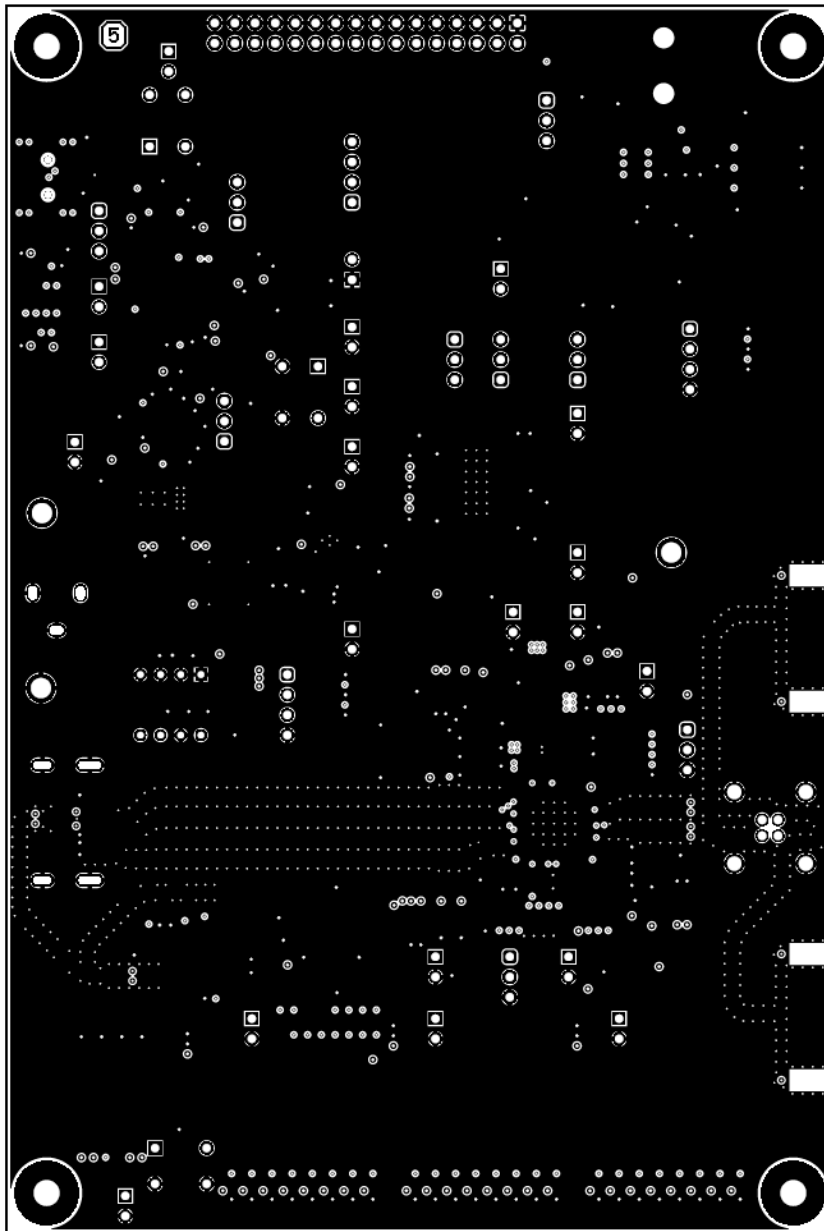

ALL ARTWORK VIEWED FROM TOP SIDE	BOARD #: HSDC016	REV: B	SUN REV: Not In VersionControl
LAYER NAME = GND	TID #: N/A		
	GENERATED : 5/15/2019 6:57:02 PM	TEXAS INSTRUMENTS	

Figure B-7. Board Layer - Ground - 2

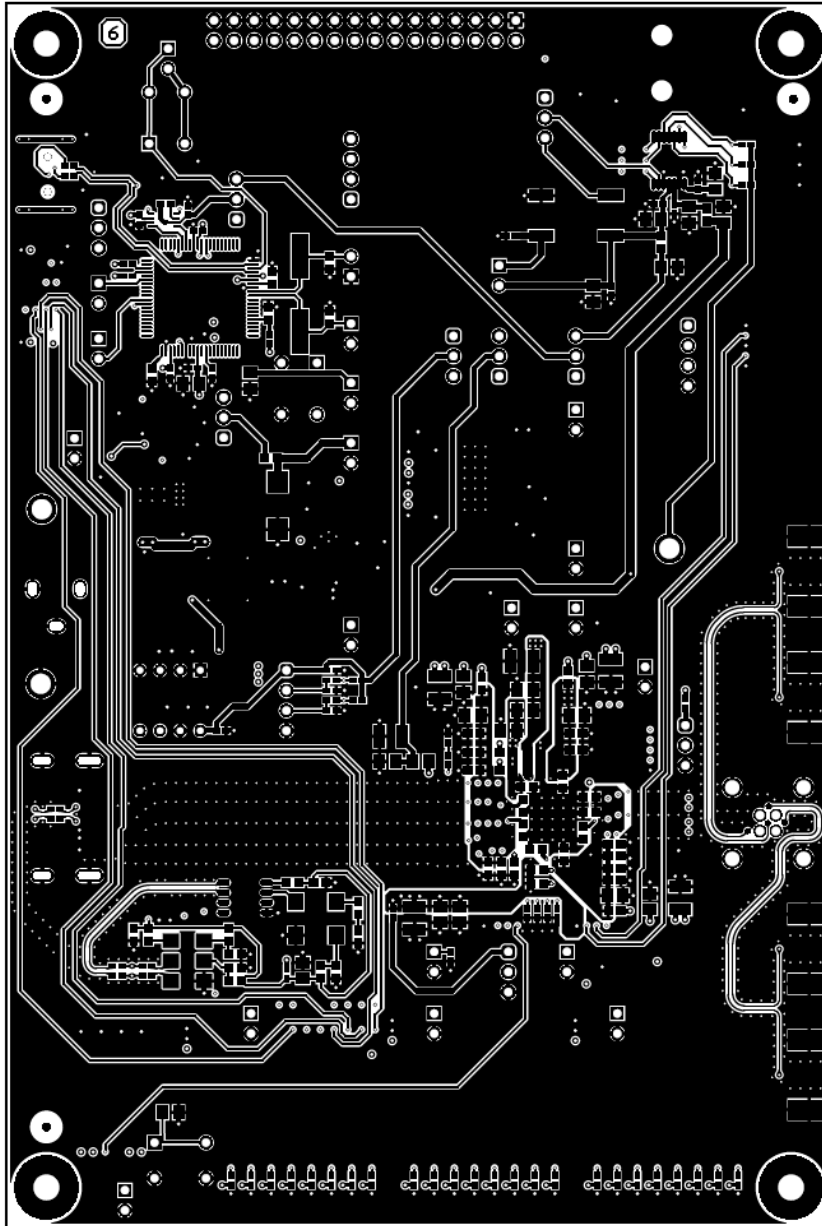

ALL ARTWORK VIEWED FROM TOP SIDE	BOARD #: HSDC016	REV: B	SUN REV: Not In VersionControl
LAYER NAME = Bottom Layer	TID #: N/A		
	GENERATED : 5/15/2019 6:57:05 PM	TEXAS INSTRUMENTS	

Figure B-8. Board Layer - Bottom

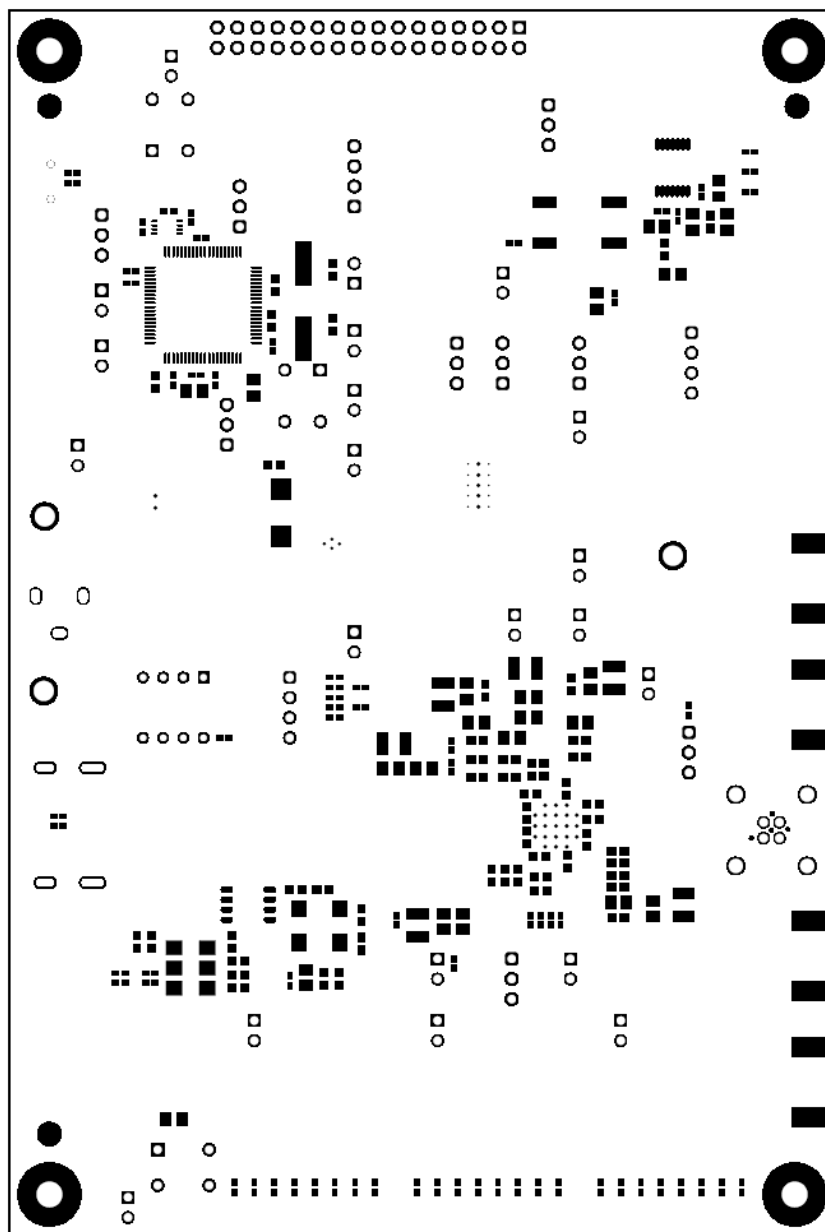

ALL ARTWORK VIEWED FROM TOP SIDE	BOARD #: HSDC016	REV: B	SUN REV: Not In VersionControl
LAYER NAME = Bottom Solder	TID #: N/A		
	GENERATED : 5/15/2019 6:57:07 PM	TEXAS INSTRUMENTS	

Figure B-9. Board Layer - Bottom Solder

Revision History

NOTE: Page numbers for previous revisions may differ from page numbers in the current version.

Changes from Original (August 2018) to A Revision	Page
• Added DS90UB949A-Q1EVM information	5
• Added content to the <i>General Description</i> section.....	5
• Changed S4, S7, S8 BOM information	34
• Changed U6 BOM information	35

IMPORTANT NOTICE AND DISCLAIMER

TI PROVIDES TECHNICAL AND RELIABILITY DATA (INCLUDING DATA SHEETS), DESIGN RESOURCES (INCLUDING REFERENCE DESIGNS), APPLICATION OR OTHER DESIGN ADVICE, WEB TOOLS, SAFETY INFORMATION, AND OTHER RESOURCES "AS IS" AND WITH ALL FAULTS, AND DISCLAIMS ALL WARRANTIES, EXPRESS AND IMPLIED, INCLUDING WITHOUT LIMITATION ANY IMPLIED WARRANTIES OF MERCHANTABILITY, FITNESS FOR A PARTICULAR PURPOSE OR NON-INFRINGEMENT OF THIRD PARTY INTELLECTUAL PROPERTY RIGHTS.

These resources are intended for skilled developers designing with TI products. You are solely responsible for (1) selecting the appropriate TI products for your application, (2) designing, validating and testing your application, and (3) ensuring your application meets applicable standards, and any other safety, security, regulatory or other requirements.

These resources are subject to change without notice. TI grants you permission to use these resources only for development of an application that uses the TI products described in the resource. Other reproduction and display of these resources is prohibited. No license is granted to any other TI intellectual property right or to any third party intellectual property right. TI disclaims responsibility for, and you will fully indemnify TI and its representatives against, any claims, damages, costs, losses, and liabilities arising out of your use of these resources.

TI's products are provided subject to [TI's Terms of Sale](#) or other applicable terms available either on ti.com or provided in conjunction with such TI products. TI's provision of these resources does not expand or otherwise alter TI's applicable warranties or warranty disclaimers for TI products.

TI objects to and rejects any additional or different terms you may have proposed.

Mailing Address: Texas Instruments, Post Office Box 655303, Dallas, Texas 75265
Copyright © 2022, Texas Instruments Incorporated