

DS90UH925QSEVB User's Guide

LIST OF FIGURES	1
LIST OF TABLES	1
1. INTRODUCTION	2
1.1. CONTENTS OF DS90UH925QSEVB	2
1.2. HIGHLIGHTS OF EVB	2
1.3. OPERATION – QUICK SETUP	3
1.4. TROUBLE SHOOTING THE EVB.....	3
2. BOARD SETUP DETAILS	4
2.1. POWER CONNECTIONS.....	4
2.2. FPD-LINK III CONNECTION	4
2.3. FACTORY SET SWITCH SETTINGS AND JUMPERS DEFAULT CONFIGURATION	4
2.4. LVCMOS INPUT CONNECTOR DESCRIPTION.....	5
3. APPENDIX – I2C, INTEGRATED SPA DONGLE	6
3.1. I2C SPA DONGLE HOOKUP	6
3.2. IDX BOARD DEFAULT ADDRESS	6
3.3. ALP SOFTWARE SETUP	7
3.3.1. SYSTEM REQUIREMENTS	7
3.3.2. CD CONTENTS	7
3.3.3. INSTALLATION OF THE ALP SOFTWARE	7
3.3.4. INSTALLATION OF THE USB DRIVER.....	8
3.3.5. STARTUP - SOFTWARE DESCRIPTION	8
3.3.6. TROUBLE SHOOTING ALP SOFTWARE	16
4. APPENDIX – USE OF OPTIONAL ROSENBERGER HSD CONNECTOR (J1).....	18
5. APPENDIX – USE OF OPTIONAL MINI-B USB CONNECTOR (J2).....	18
6. APPENDIX - BOARD LAYOUT	18
7. SCHEMATIC.....	25
8. BILL OF MATERIALS	30

LIST OF FIGURES

Figure 1: DS90UH925Q EVB.....	2
Figure 2: Factory Switch (S1,S2,S3,S4) and Jumper (JP2) Configuration.....	5
Figure 3: Initial ALP Screen	9
Figure 4: TOP View.....	19
Figure 5: BOTTOM View.....	20
Figure 6: TOP Layer	21
Figure 7: GND Layer.....	22
Figure 8: PWR Layer	23
Figure 9: BOTTOM Layer	24

LIST OF TABLES

Table 1: Bill of Materials.....	30
---------------------------------	----

1. Introduction

The Texas Instruments DS90UH925QSEVB evaluation kit (EVB) provides an easy way to evaluate the operation and performance of the DS90UH925Q 2.975Gbps FPD-Link III serializer.

1.1. Contents of DS90UH925QSEVB

1- DS90UH925Q EVB, 1- CD with ALP software, 1- USB cable

1.2. Highlights of EVB

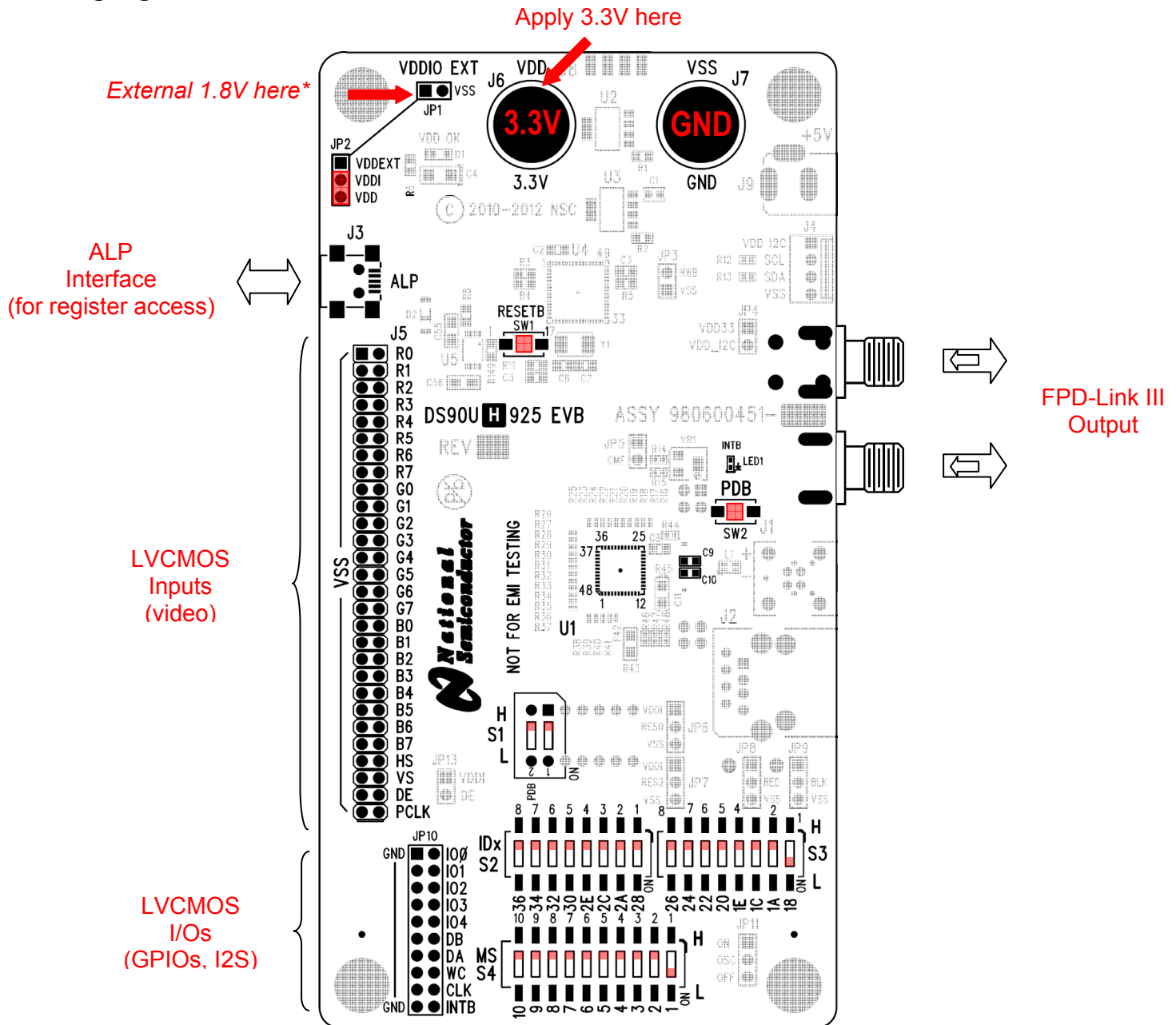

Figure 1: DS90UH925Q EVB

* The default factory configuration is VDDIO = 3.3V. 3.3V does not have to be applied externally. To interface to 1.8V inputs, 1.8V must be applied externally. For VDDIO = 1.8V, move jumper on JP2 to short pins 1 and 2.

1.3. Operation – Quick Setup

Make sure S1, S2, S3, S4, and JP2 are configured as shown in Figure 1.

- 1) Turn on the deserializer.

Typically this would be the DS90UH926Q EVB.

- 2) If interfacing to 3.3V LVCMOS, skip this step, otherwise:
when interfacing to 1.8V LVCMOS inputs (upstream device), move factory jumper from pin-2/3 to pin 1 to connect to pin-1/2 and apply 1.8V power to pin 1 of JP1. This will connect the external 1.8V to the DS90UH925Q VDDIO, otherwise skip this step.

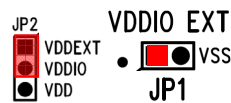

- 3) Apply 3.3V power to the DS90UH925Q VDD.



- 4) Look for the green LED2 to light up on the DS90UH926Q EVB. If the green LED is lit and stable, then the DS90UH926Q is **LOCKED** to the FPD-Link III serial stream. To be absolutely sure the DS90UH926Q is locked, use a scope to monitor off JP6 (pin 1 = LOCK, pin 2 = VSS) of the DS90UH926QSEVB.

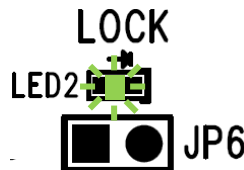

CONGRATULATIONS, you are up and running!

If not continue to the next step...

1.4. Trouble Shooting the EVB

- 1) Check power supply polarity!!! Warning: reverse supply polarity can damage the board.
- 2) Check to make sure there is sufficient current by checking that the voltage (3.3V) is correct at J6.
- 3) Check polarity of SER to DES cable interface. e.g. SER DOUT+ is going to RIN+ of DES and vice versa.
- 4) Check to make sure there is a FPD-Link III signal by probing on **both** C9 AND C10.
- 5) Go back to figure 1 and double check factory settings.

2. Board Setup Details

This section describes, in detail, the connectors and jumpers on the board as well as how to properly connect, set up, and use the DS90UH925Q EVB.

2.1. Power Connections

- 1) Connect ground to J7.
- 2) Connect an external 3.3V into J6. This is the core voltage of the DS90UH925Q.

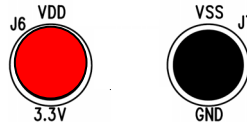

- 3) For VDDIO = 1.8V, connect ground to pin 2 of JP1.
- 4) Connect an external 1.8V into pin 1 of JP1. This is VDDIO power.

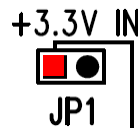

2.2. FPD-Link III Connection

J10, J11 – is the default SMA connector. The FPD-Link III serial stream comes out on J10 and J11. Note: J10 is DOUT+, J11 is DOUT- of the DS90UH925Q. Connect to the deserializer from these two SMAs. Typically the deserializer will be the DS90UH925Q.

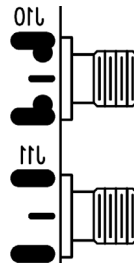

2.3. Factory Set Switch Settings and Jumpers Default Configuration

S1, S2, S3, S4 and JP2 are factory configured as shown in Figure 2 for plug and play operation. For each of these 3-pin headers JP2, a jumper must be placed as shown.

- 1) The S1 switch is factory set as shown below.
The PDB switch is set *HIGH* and will turn on the DS90UH925Q upon power up.

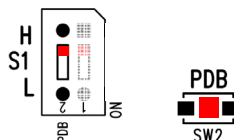

SW2 is a momentary switch. Instead of toggling switch 1 of S1 to do a PDB toggle, press SW2 to do a PDB toggle.

- 2) The S2 and S3 switches are factory set as shown below.
 All switches are set *HIGH* except 18 on S3. This sets IDx address to 18. Note only one switch is allowed *LOW* at a time.

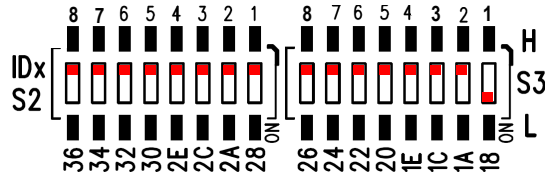

- 3) The S4 switch is factory set as shown below.
 All switches are set *HIGH* except 1. This sets MODE_SEL address to 1. Note only one switch is allowed *LOW* at a time.

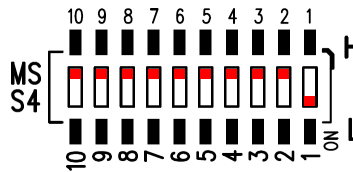

- 4) On JP2, a 2-pin jumper is factory placed as shown below.
 The jumper sets VDDIO to 3.3V. Note 3.3V does not need to be applied externally.



Figure 2: Factory Switch (S1,S2,S3,S4) and Jumper (JP2) Configuration

2.4. LVCMOS Input Connector Description

J5 – R[7:0], G[7:0], B[7:0], HS, VS, DE, PCLK is the input connector for the DS90UH925Q data inputs. These are the LVCMOS inputs of the DS90UH925Q. The even numbered pins (right side pins on the board) are the inputs. The odd numbered pin (left side pins on the board) is VSS.

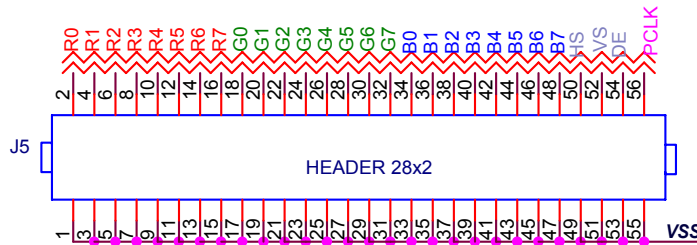

3. Appendix – I2C, integrated SPA Dongle

3.1. I2C SPA Dongle Hookup

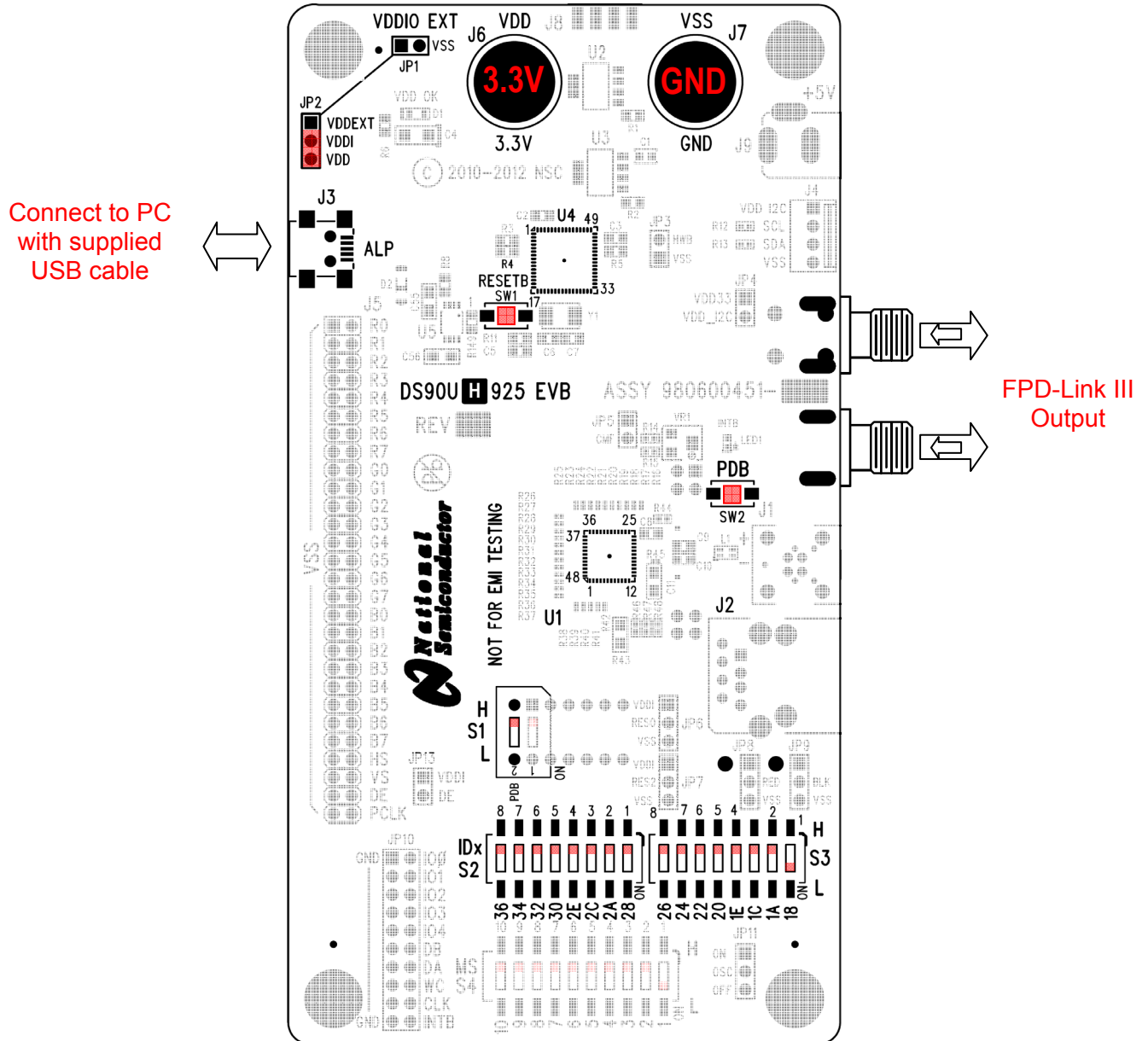

3.2. IDx Board Default Address

The IDx address on the EVB has been preset at 18.

3.3. ALP Software Setup

3.3.1. System Requirements

Operating System: Windows XP or Vista
USB: 2.0

3.3.2. CD contents

Extract the “ALPF_XXXXXXXXX_XXX_XXXX.exe” file to a temporary location that can be deleted later.

Make sure J4 on the DS90UH925 is connected to a PC USB port with the supplied USB cable and power is applied to the DS90UH925 EVB

The following installation instructions are for the Windows XP Operating System.

3.3.3. Installation of the ALP software

Execute the ALP Setup Wizard program called “ALPF_monthdayyear_major version_minor version.exe” that was extracted to a temporary location on the local drive of your PC.

There are 7 steps to the installation once the setup wizard is started:

1. Select the “Next” button.
2. Select “I accept the agreement” and then select the “Next” button.
3. Select the location to install the ALP software and then select the “Next” button.
4. Select the location for the start menu shortcut and then select the “Next” button.
5. There will then be a screen that allows the creation of a desktop and Quick Launch icon. After selecting the desired choices select the “Next” button.
6. Select the “Install” button, and the software will then be installed to the selected location.
7. Uncheck “Launch Analog LaunchPAD” and select the “Finish” button. The ALP software will start if “Launch Analog LaunchPAD” is checked, but it will not be useful until the USB driver is installed.

Connect J3 of the DS90UH925Q EVB board to a PC/laptop with the supplied mini USB cable. Power the DS90UH925Q EVB board with a 3.3 VDC power supply. The “Found New Hardware Wizard” will open on the PC/laptop. Proceed to the next section to install the USB driver.

3.3.4. Installation of the USB driver

There are 6 steps to install the USB driver:

1. Select “No, not at this time” then select the “Next” button.
2. Select “Install from a list or specific location” then select the “Next” button.
3. Select “Search for the best driver in these locations”. Uncheck “Search removable media” and check “Include this location in the search”.
4. Browse to the Install Directory which is typically located at “C:\Program Files\National Semiconductor Corp\Analog LaunchPAD\vx.x.x\Drivers” and select the “Next” button. Windows should find the driver.
5. Select “Continue Anyway”.
6. Select the “Finish” button.

The software installation is complete. The ALP software may now be launched, as described in the next section.

3.3.5. Startup - Software Description

Make sure all the software has been installed and the hardware is powered on and connected to the PC. Execute “Analog LaunchPAD” from the start menu. The default start menu location is “Programs\National Semiconductor Corp\Analog LaunchPAD vx.x.x\Analog LaunchPAD”.



The application should come up in the state shown in the figure below. If it does not, see “Trouble Shooting” at the end of this document.

Under the Devices tab click on “DS90UH925” to select the device and open up the device profile and its associated tabs.

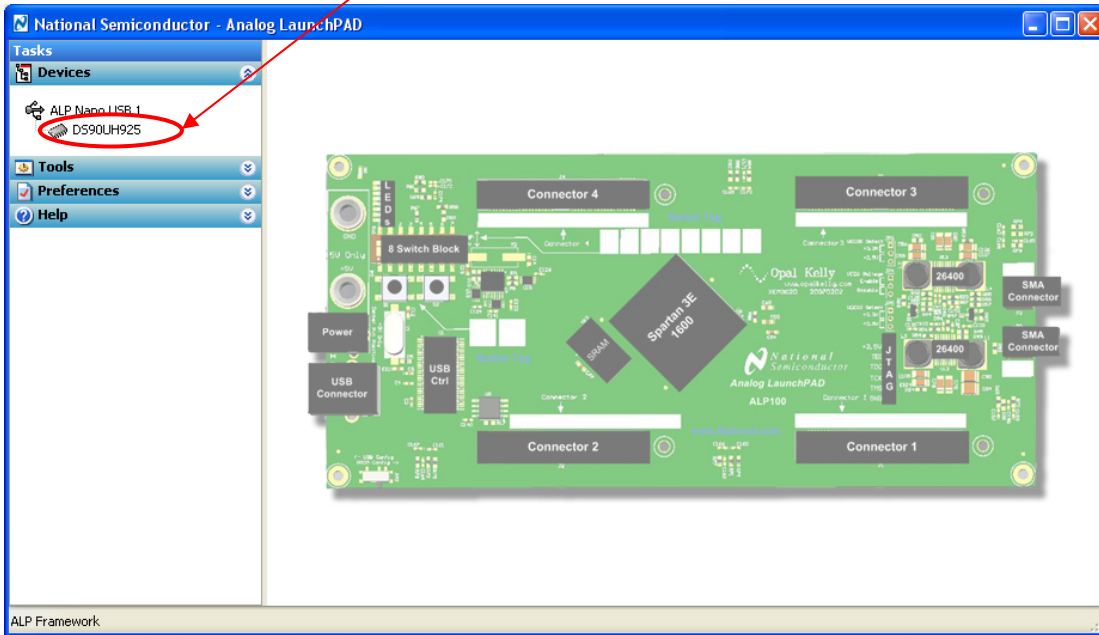
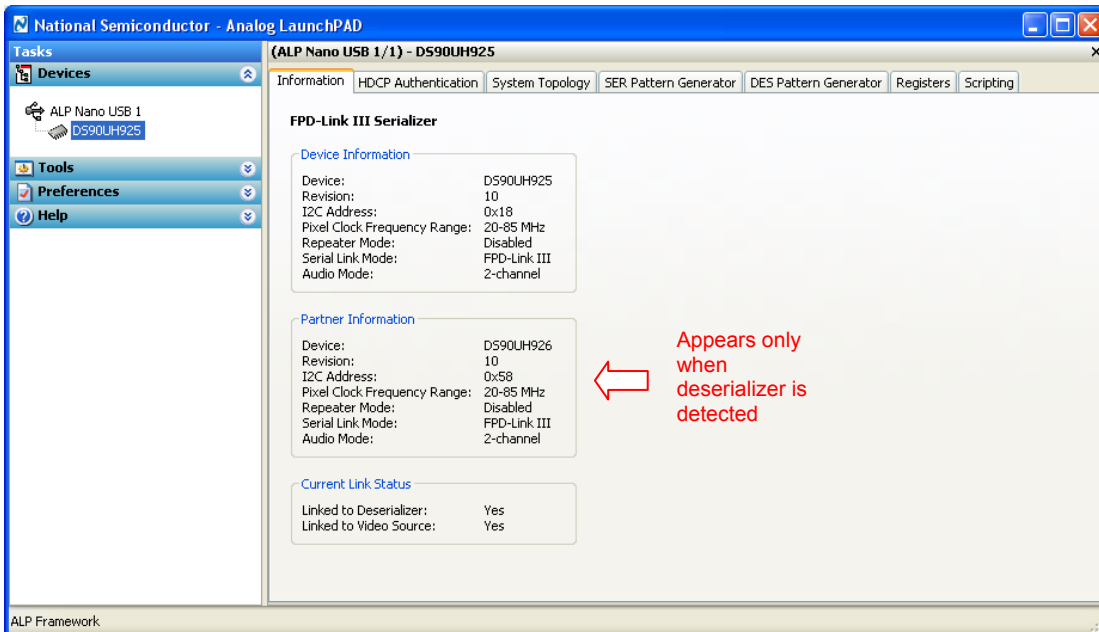

Figure 3: Initial ALP Screen

After selecting the DS90UH925, the following screen should appear.



Information Tab

The Information tab is shown below. Please note the device revision could be different.

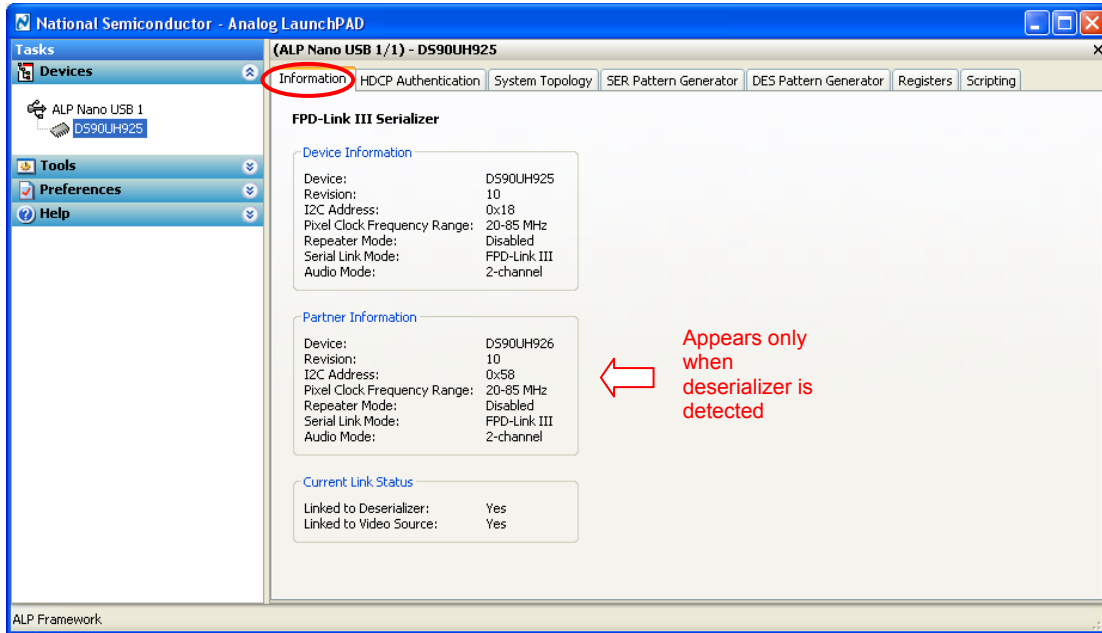

HDCP Authentication Tab

The HDCP Authentication tab is shown below.

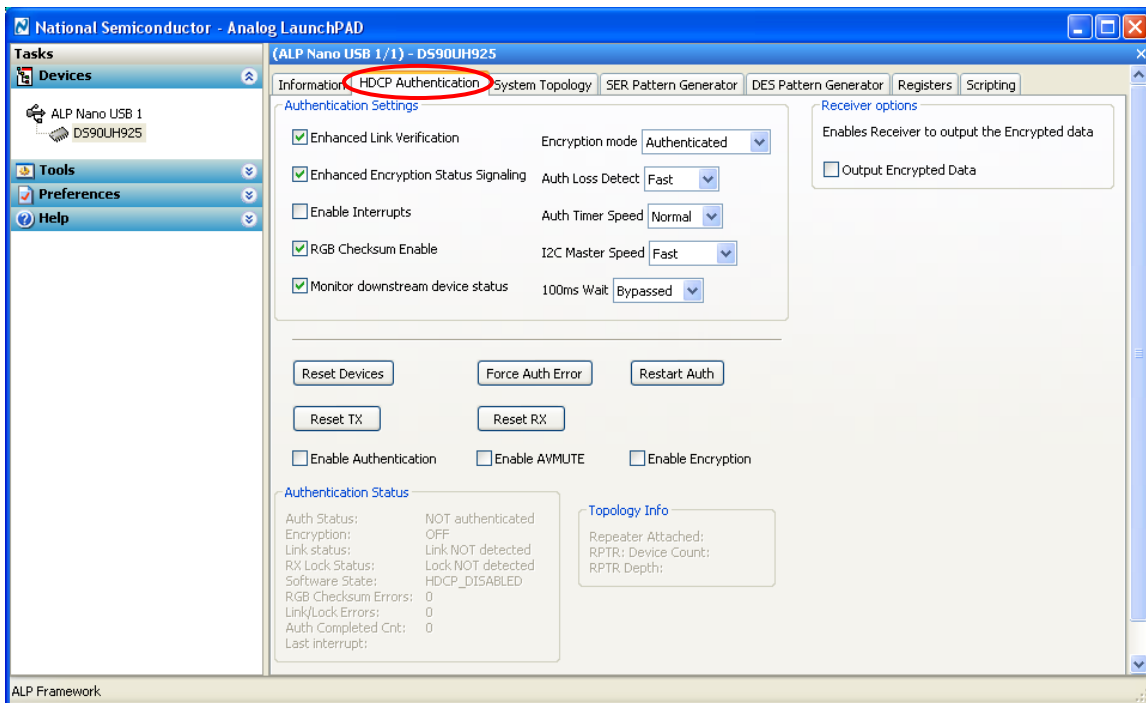

System Topology Tab

The System Topology tab is shown below.

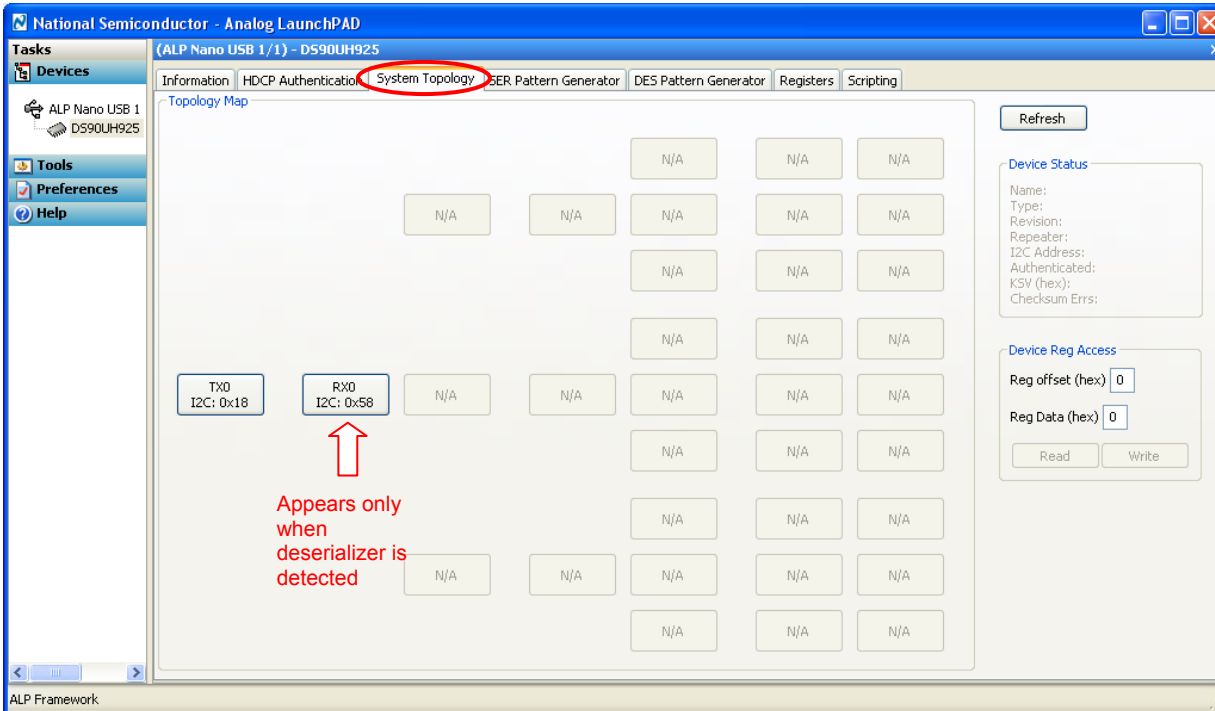

SER Pattern Generator Tab

The SER Pattern Generator tab is shown below.

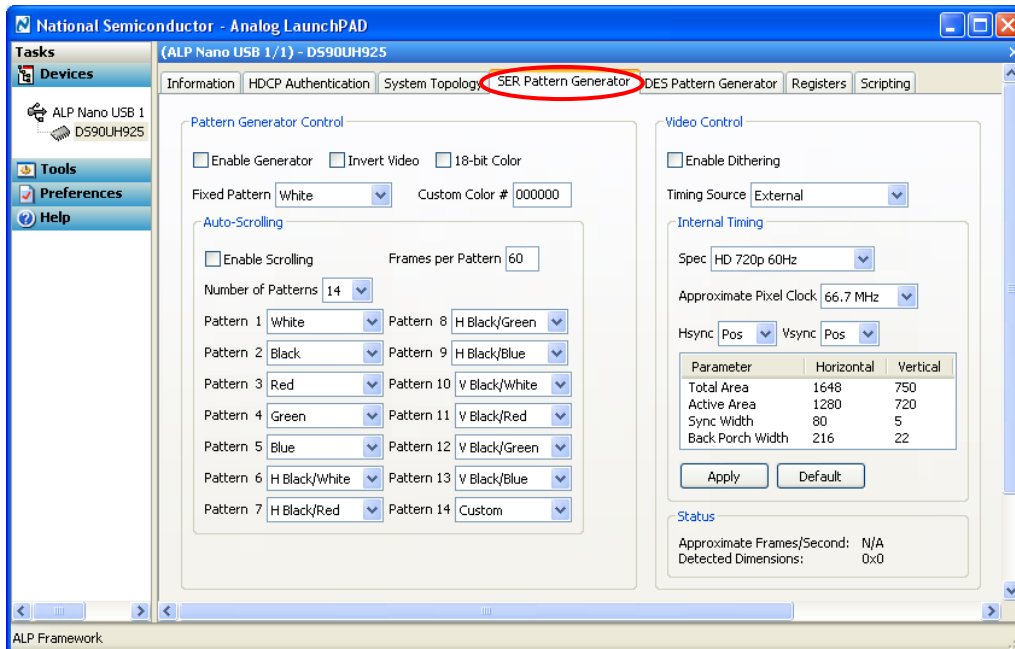

DES Pattern Generator Tab

The DES Pattern Generator tab is shown below.

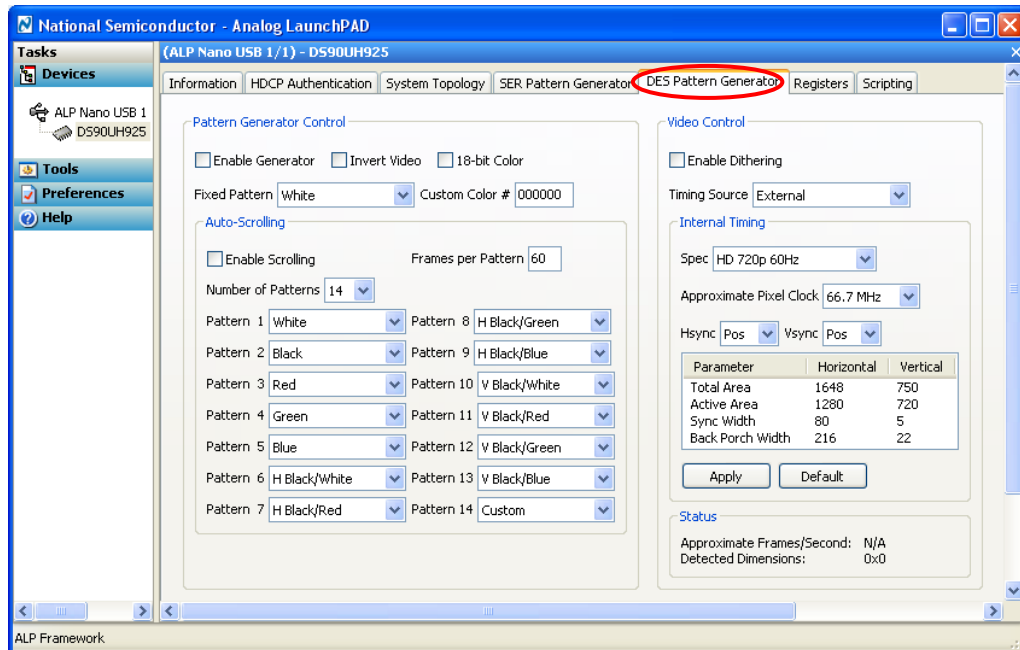

Registers Tab

The Registers tab is shown below.

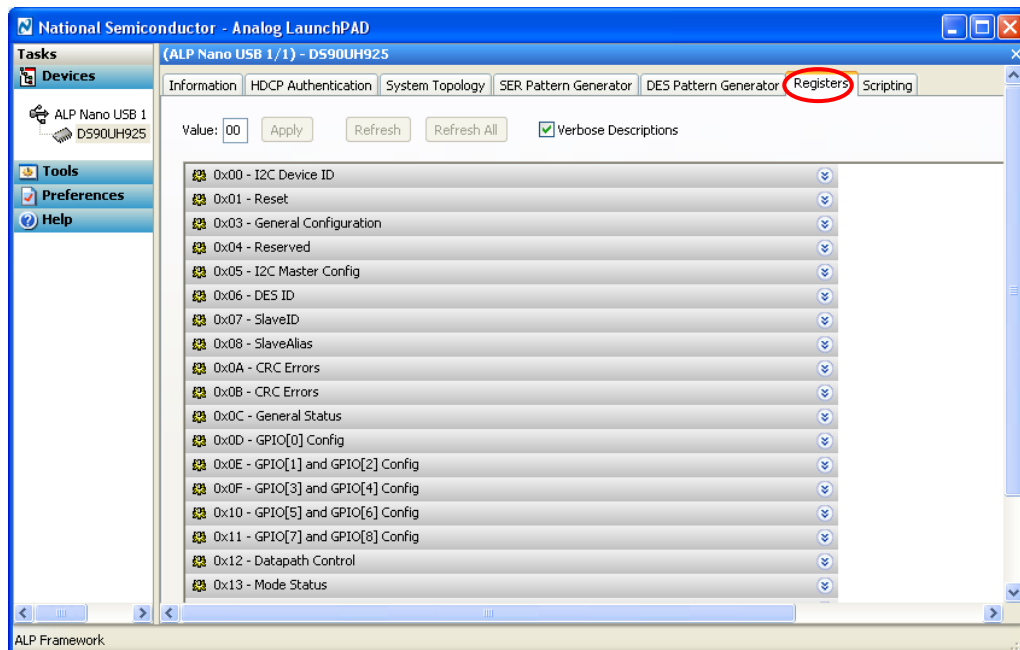

Registers Tab – Address 0x00 selected

Address 0x00 selected as shown below. Note that the “Value:” box, Value: 18, will now show the hex value of that register.

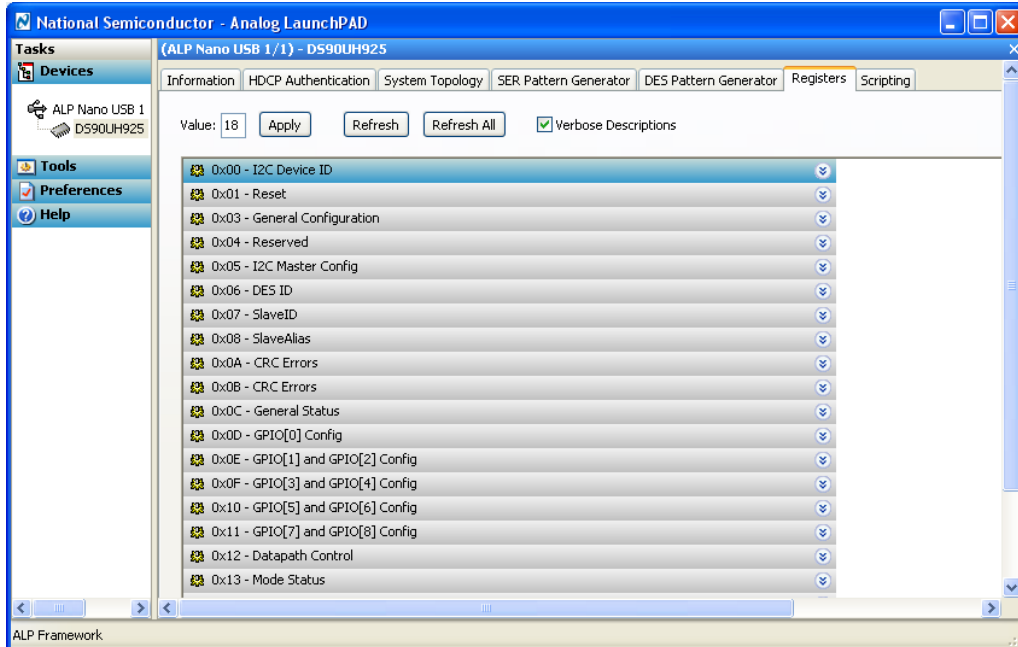

Registers Tab – Address 0x00 expanded

By double clicking on the Address bar



or a single click on  Address 0x00 expanded reveals contents by bits. Any register address displayed can be expanded.

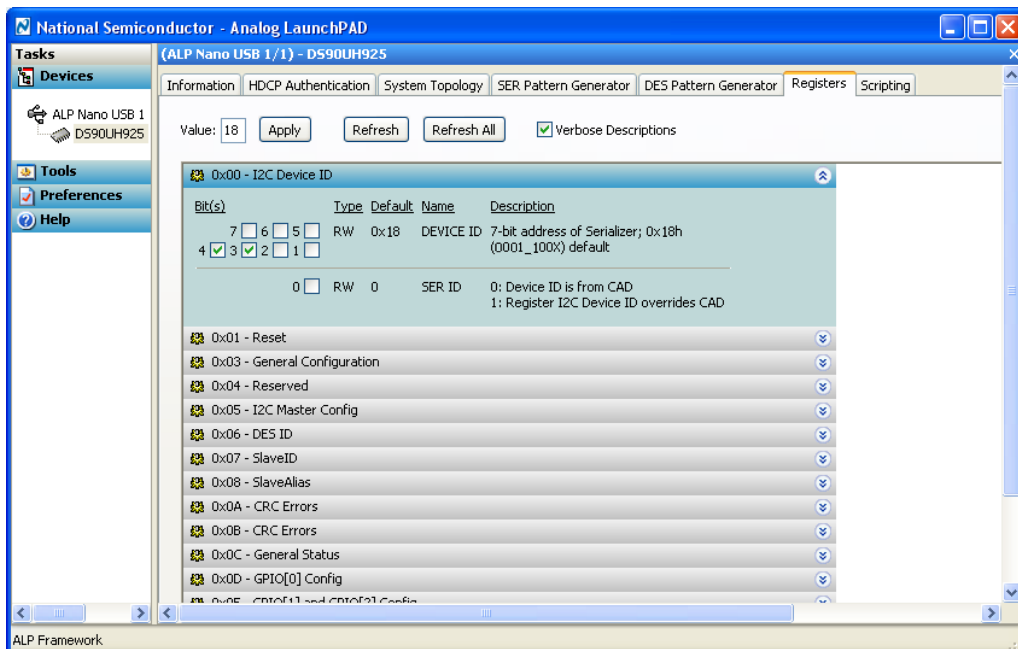

Type

Any RW Type register, **RW**, can be written into by writing the hex value into the “Value:” box, Value: **00** or putting the pointer into the individual register bit(s) box by a left mouse click to put a check mark (indicating a “1”) or unchecking to remove the check mark (indicating a “0”). Click the “Apply” button to write to the register, and “refresh” to see the new value of the selected (highlighted) register.

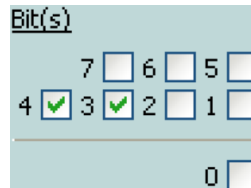

The box toggles on every mouse click.

I2C PASS ALL 0x17[7]=1

I2C PASS ALL 0x17[7] should be selected to communicate with slave devices.

Registers Tab – Address 0x17 selected

Address 0x00 selected as shown below. Note that the default “Value:” box, Value: **5E**, will now show the hex value of that register.





Registers Tab – Address 0x17 expanded

By double clicking on the Address bar

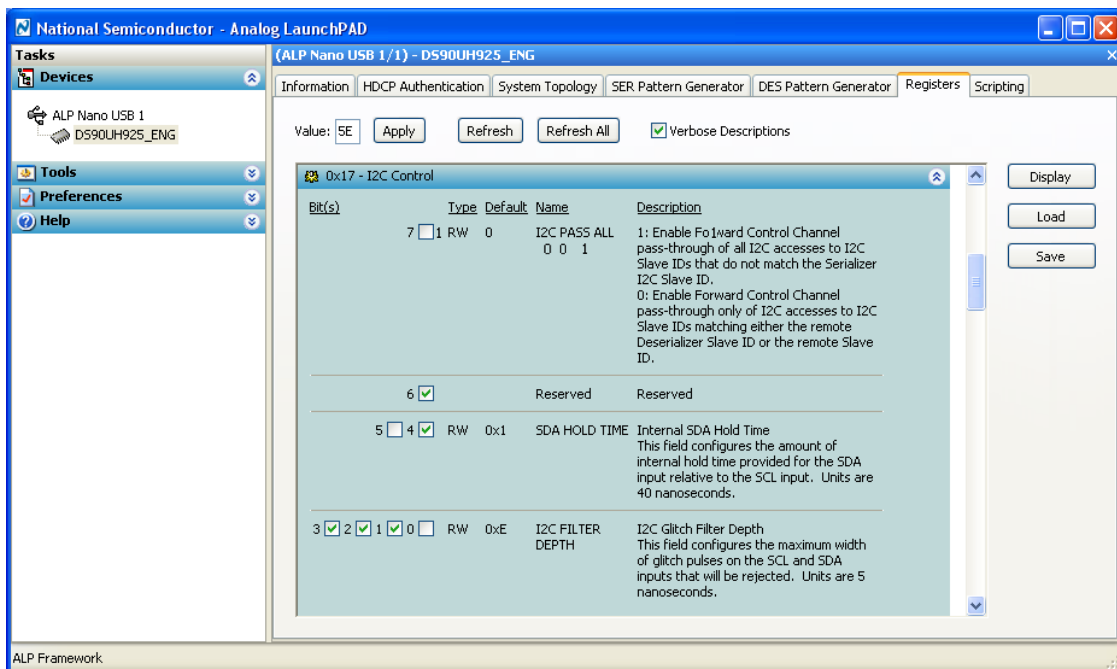

or a single click on  Address 0x17 to expand view to reveal contents by bits.



Either enter “DE” in the value box or toggle bit 7 to enable I2C PASS ALL. Click  for the register value to be written into register.

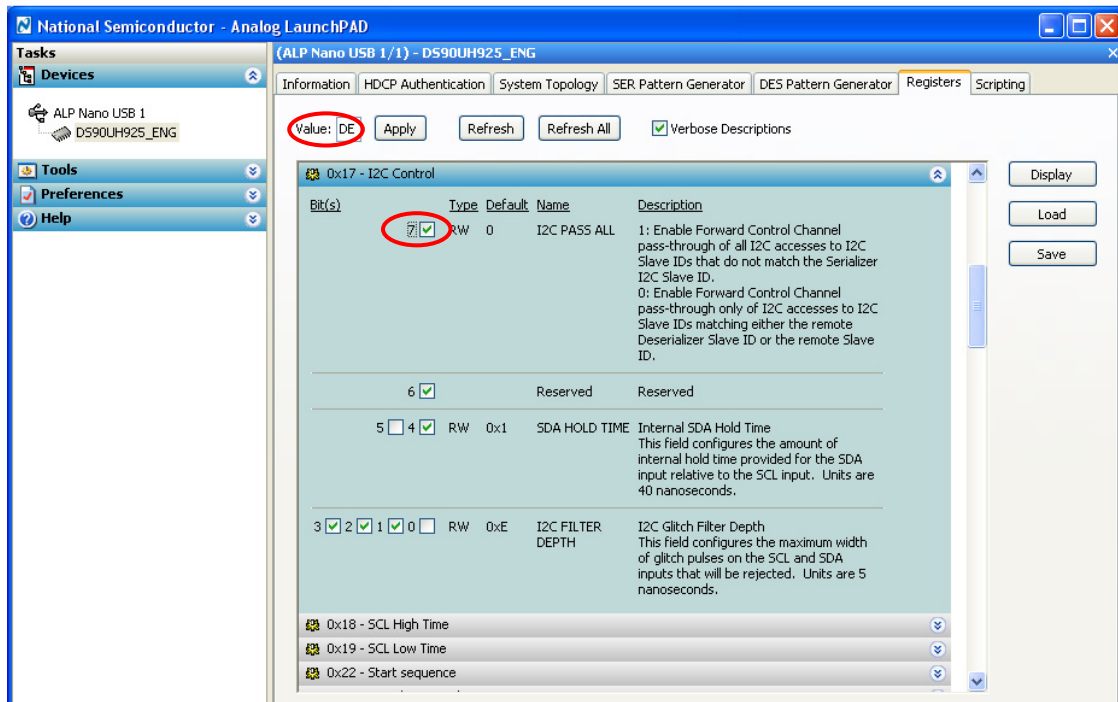

Do not select I2C PASS ALL on deserializer side if enabled on serializer side.

Scripting Tab

The Scripting tab is shown below. Usage is not described in this document.

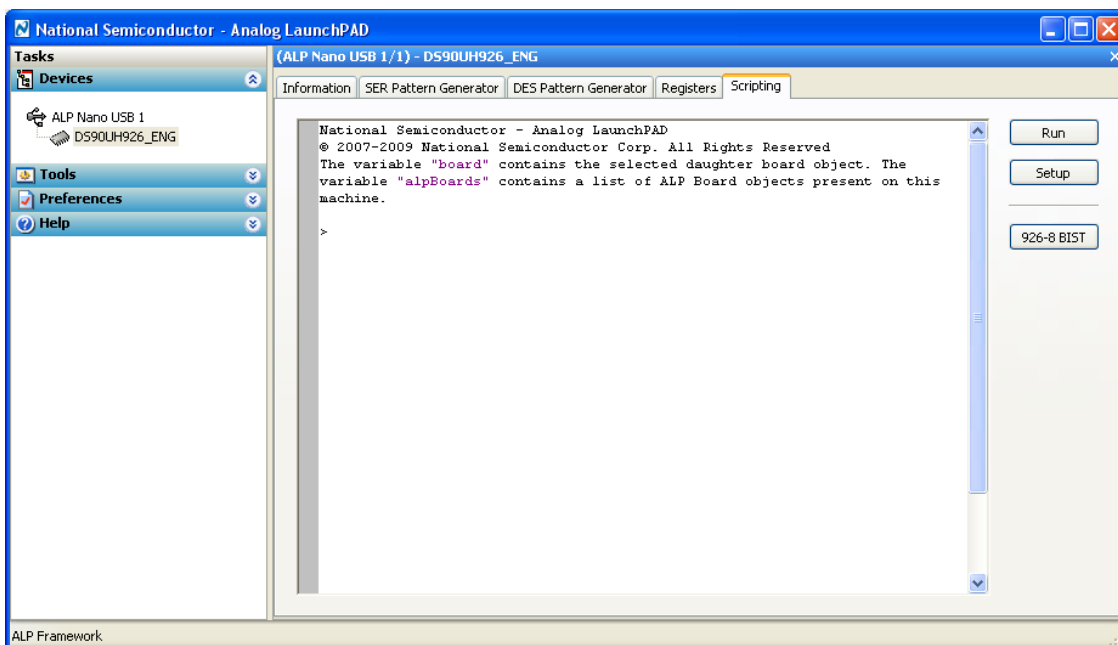

3.3.6. Trouble Shooting ALP Software

If the following window opens after starting the ALP software, double check the hardware setup.

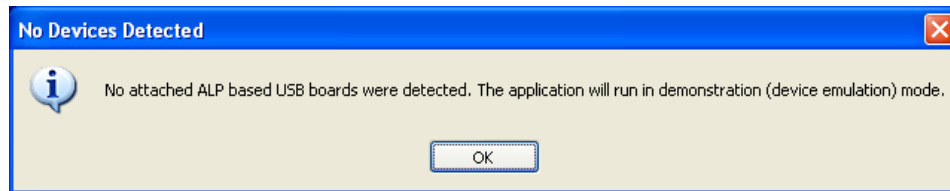

Analog LaunchPAD No Devices Error

It may also be that the USB driver is not installed. Check the device manager. There should be an “NSC ALP Nano Atmel” device under the “Universal Serial Bus Controllers” as shown below.

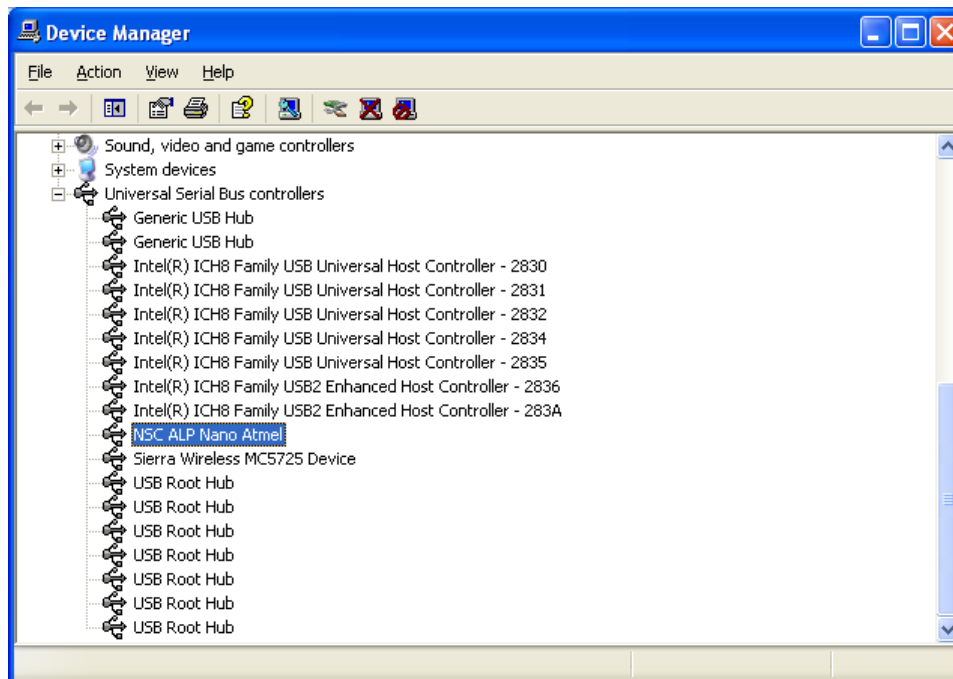

Windows XP, Analog LaunchPAD USB Driver

The software should start with only “DS90UH925Q” in the “Devices” pull down menu. If there are more devices then the software is most likely in demo mode. When the ALP is operating in demo mode there is a “(Demo Mode)” indication in the lower left of the application status bar as shown below.

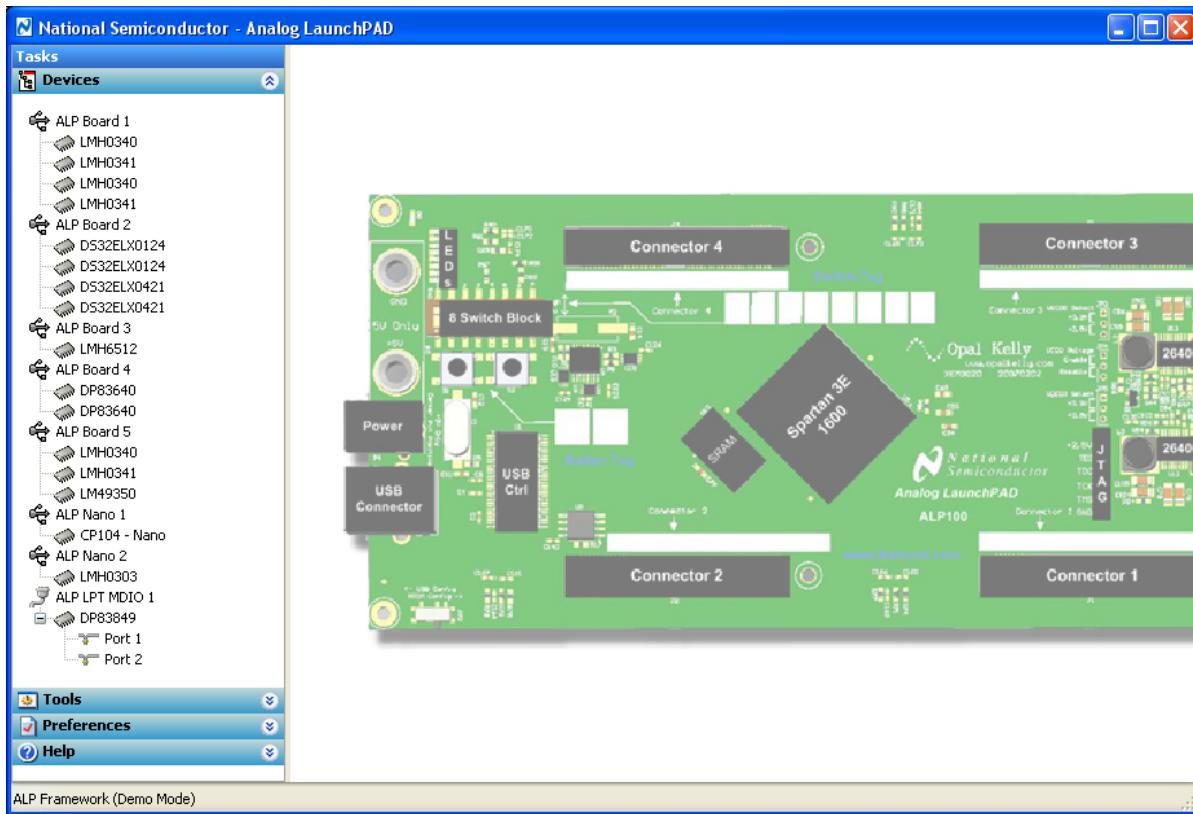

Analog LaunchPAD in Demo Mode

Disable the demo mode by selecting the “Preferences” pull down menu and unchecking “Enable Demo Mode”.

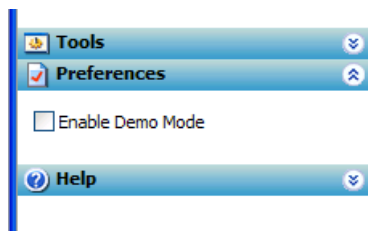

Analog LaunchPAD Preferences Menu

After demo mode is disabled, the ALP software will poll the ALP hardware. The ALP software will update and have only “DS90UH925Q” under the “Devices” pull down menu.

4. Appendix – Use of optional Rosenberger HSD connector (J1)

Unpopulate R68 and R71 0201 sized 0Ω resistor. R68 and R71 pads are on the back side of the EVM. This will cut the stub traces to J12 and J13 (SMAs). Populate J1 (Rosenberger HSD connector).

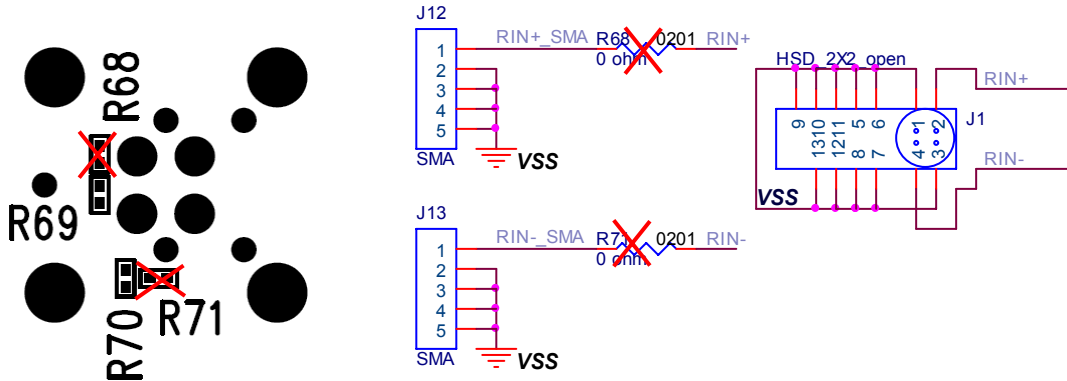

5. Appendix – Use of optional mini-B USB connector (J2)

Use this option when connecting to standard DS90UR905Q EVB.

Populate R69 and R70 with 0201 sized 0Ω resistor (suggest Panasonic ERJ-1GE0R00C or equivalent). R69 and R70 pads are on the back side of the EVM under J1. This will connect J2. Ideally, J1 (Rosenberger HSD connector) should be removed to eliminate the stub. Warning: R68 and R71 should not be populated when using J2.

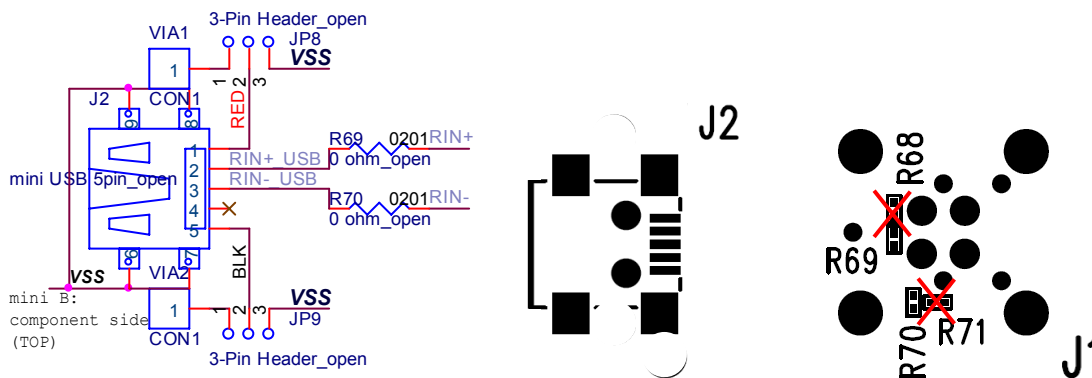

Add a two pin jumper on JP8 and JP9; this will ground the unused wires in the USB cable.

6. Appendix - Board Layout

Figure 5, Figure 6, Figure 7, and Figure 8 show the board layout for the DS90UH925Q EVB.

The DS90UH925Q is a 4-layer board (TOP / GND / PWR / BOTTOM). The 50Ω microstrip trace on the top layer of the board is referenced to GND, and the 100Ω differential traces are referenced to GND.

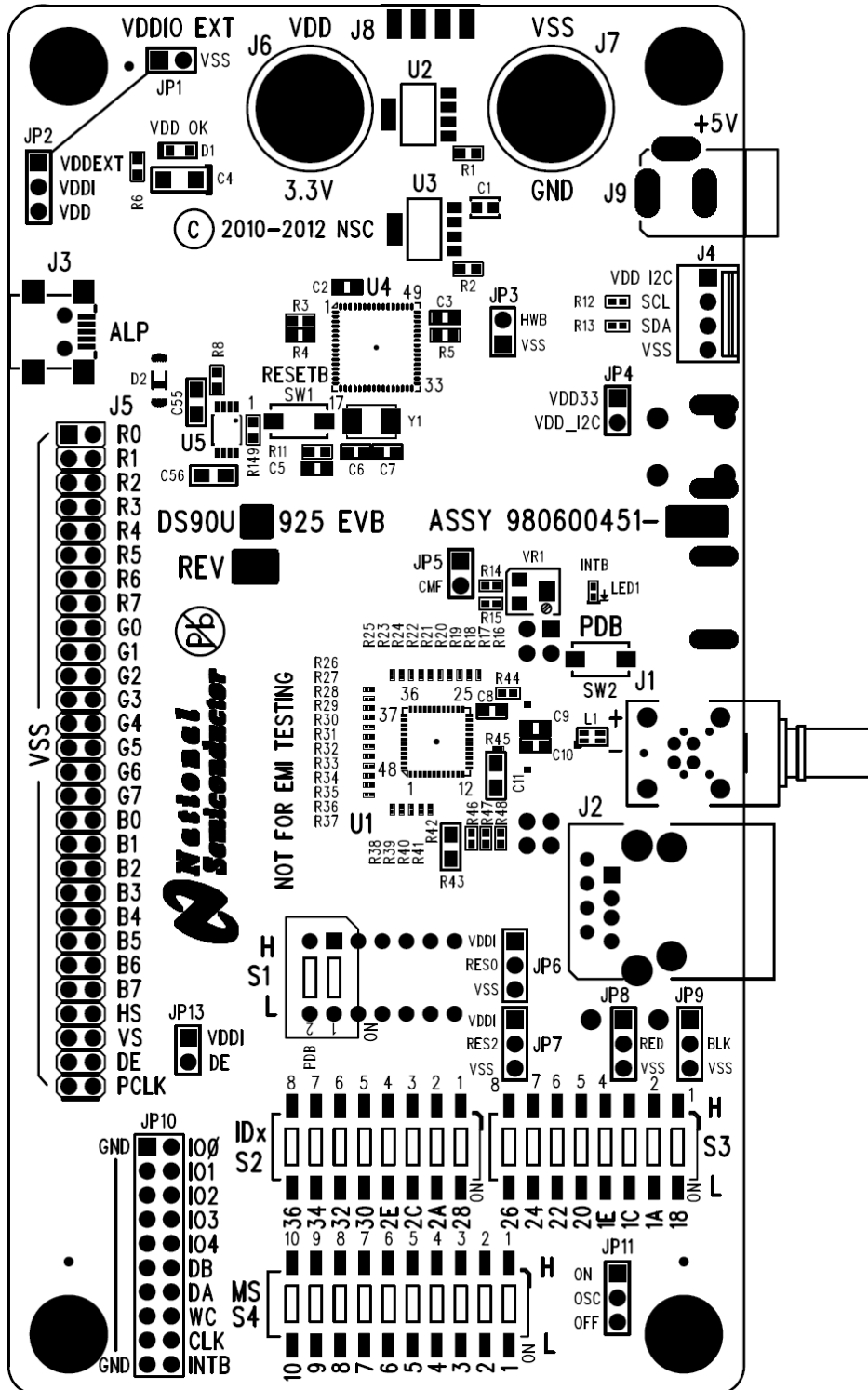

Figure 4: TOP View

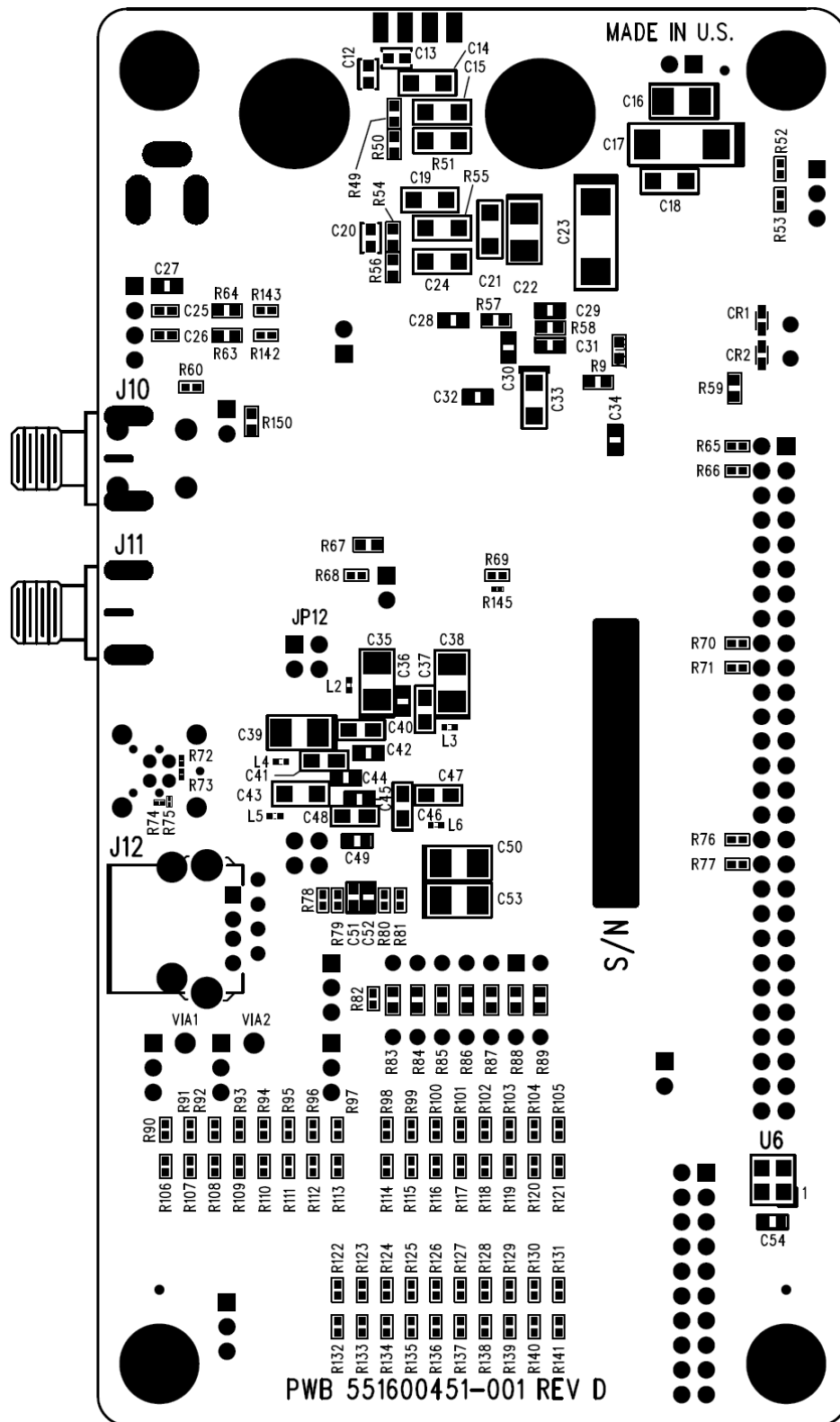

Figure 5: BOTTOM View

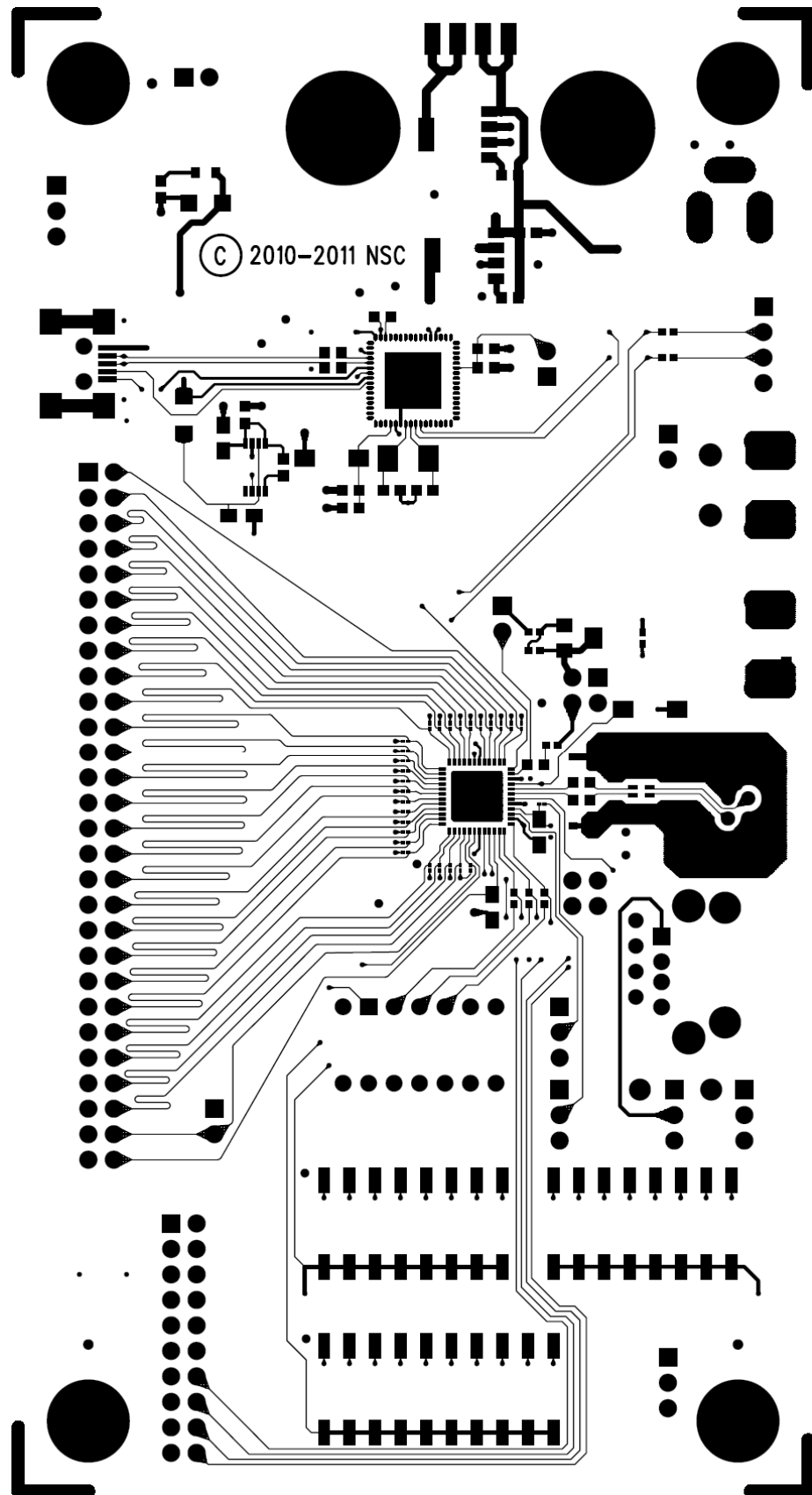

Figure 6: TOP Layer

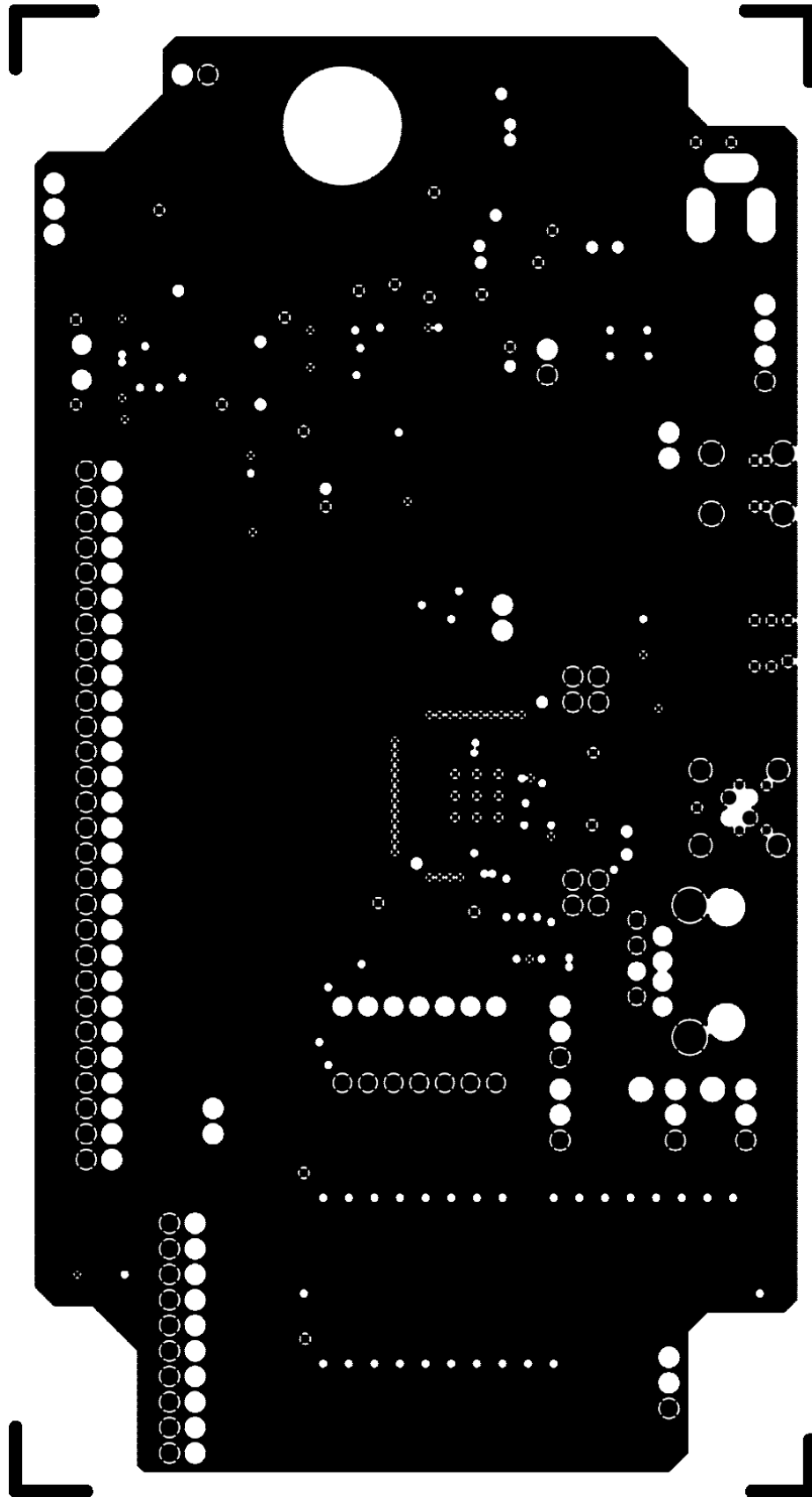

Figure 7: GND Layer

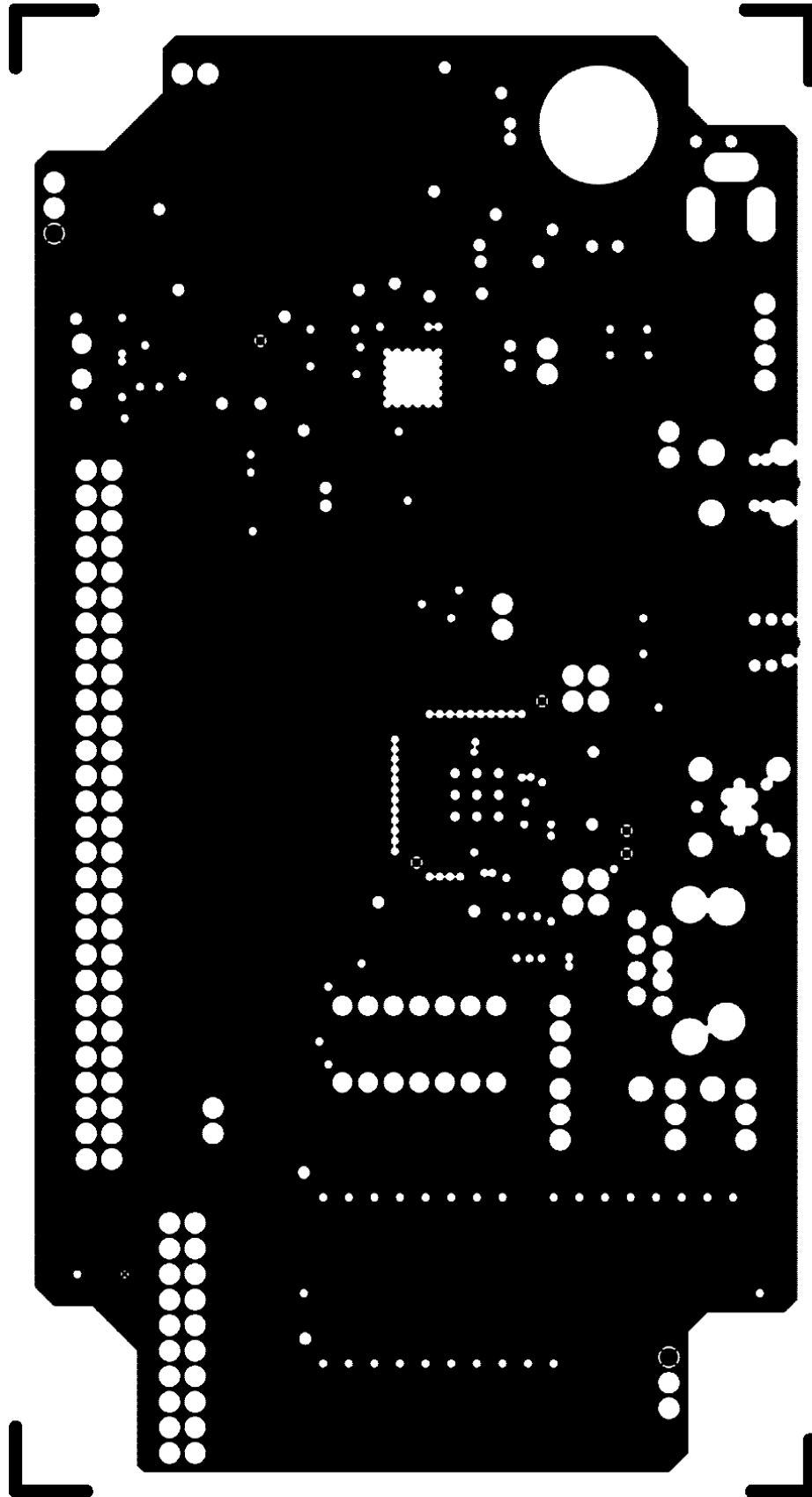

Figure 8: PWR Layer

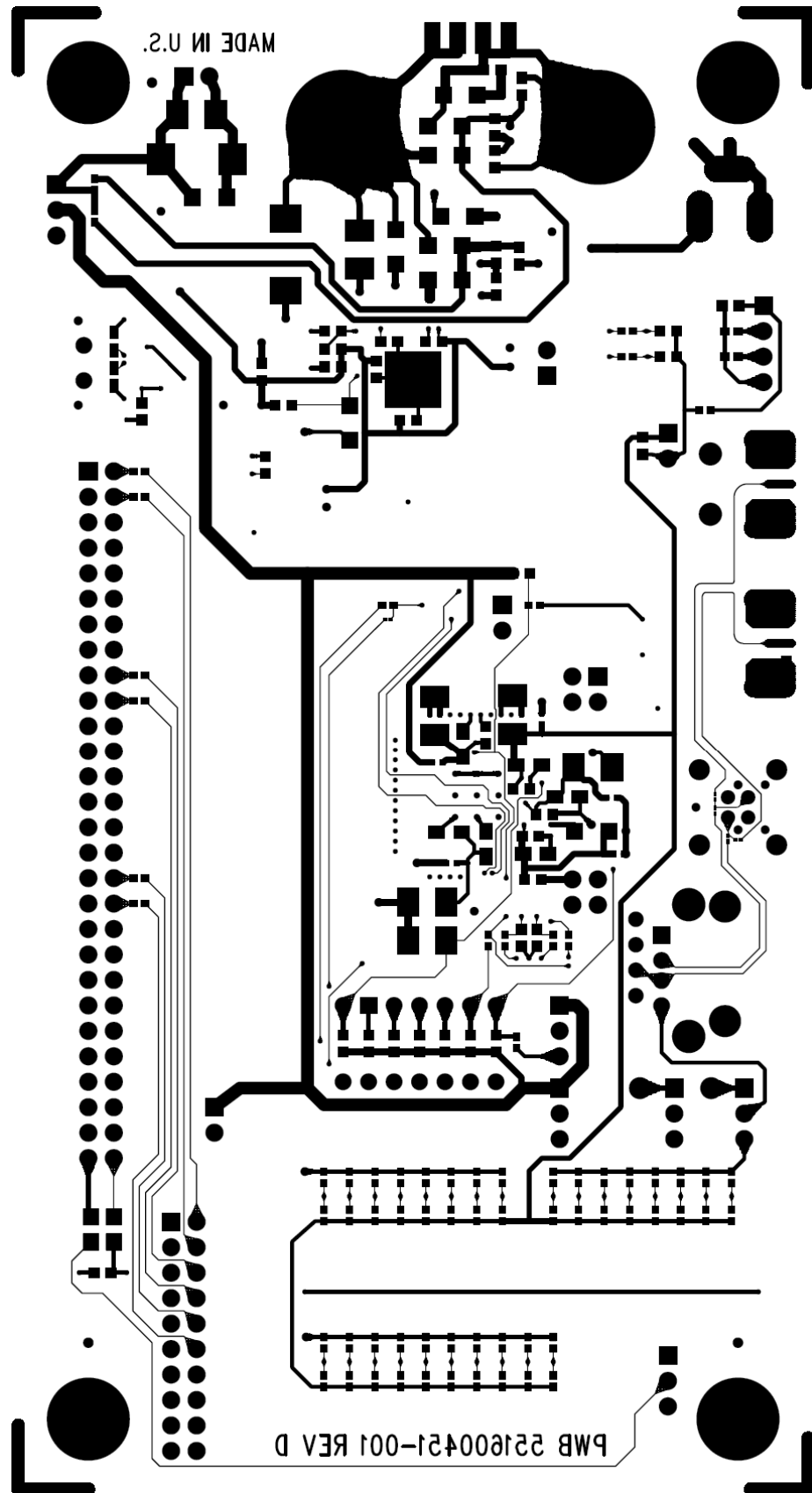
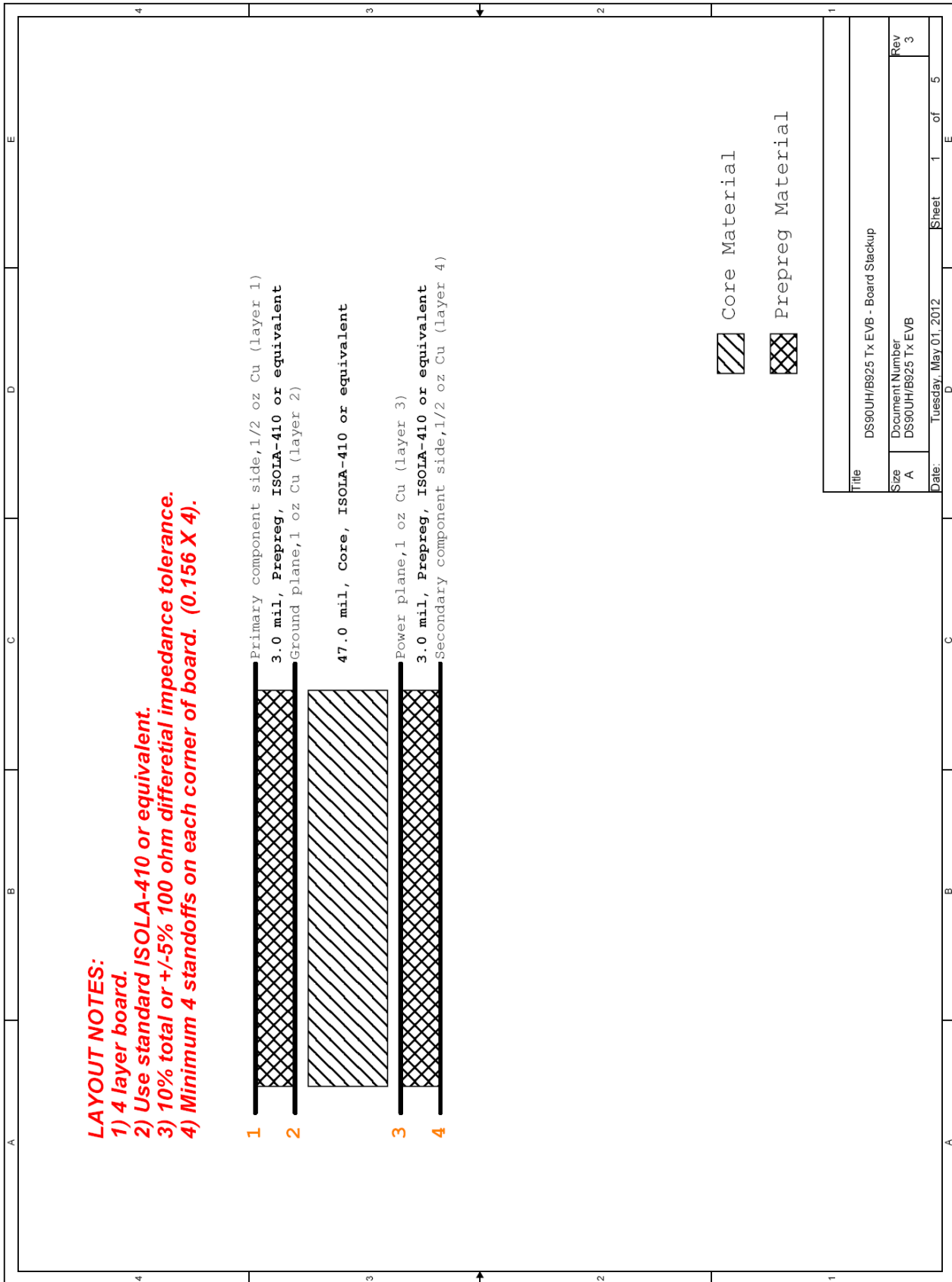
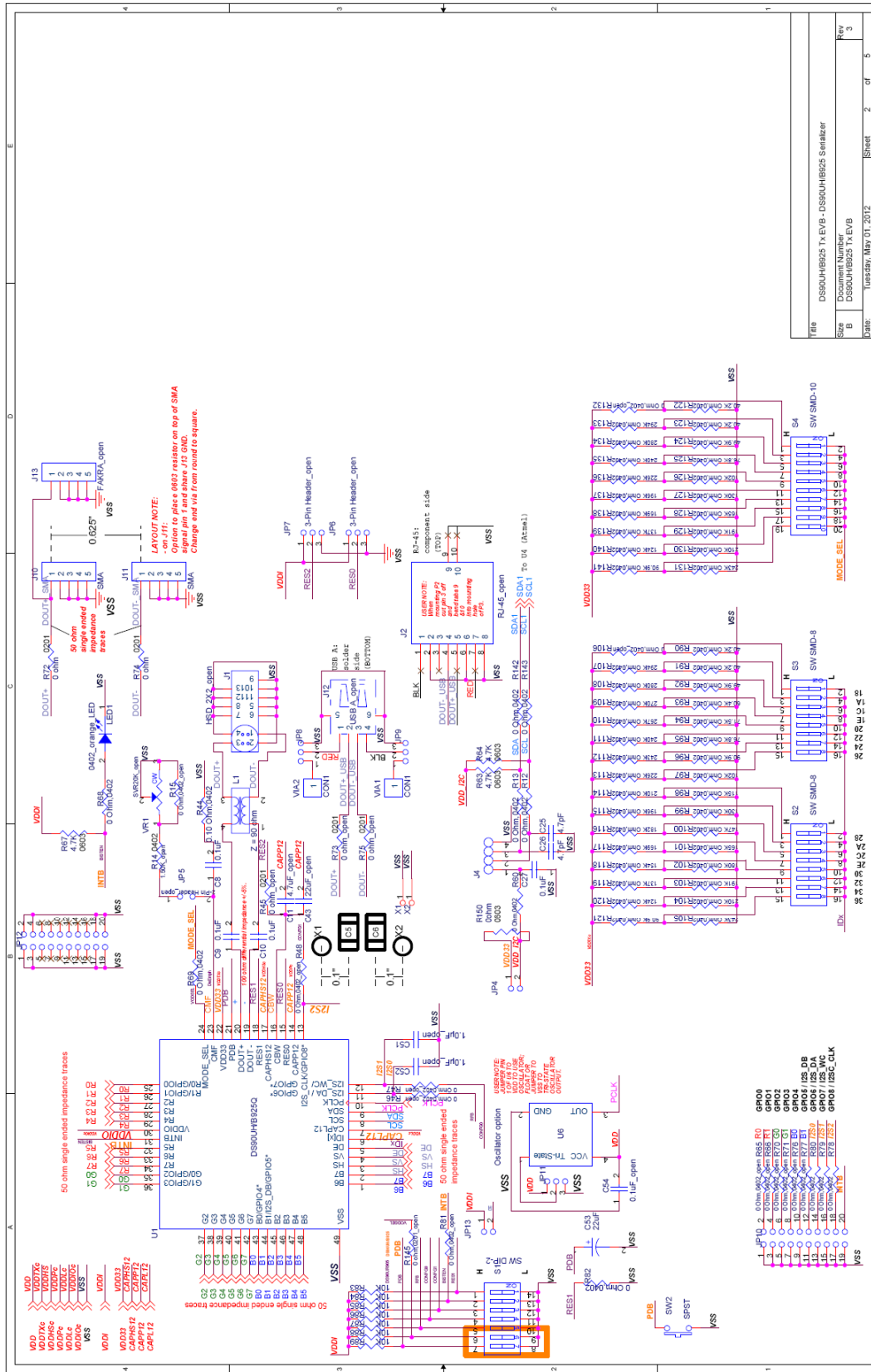
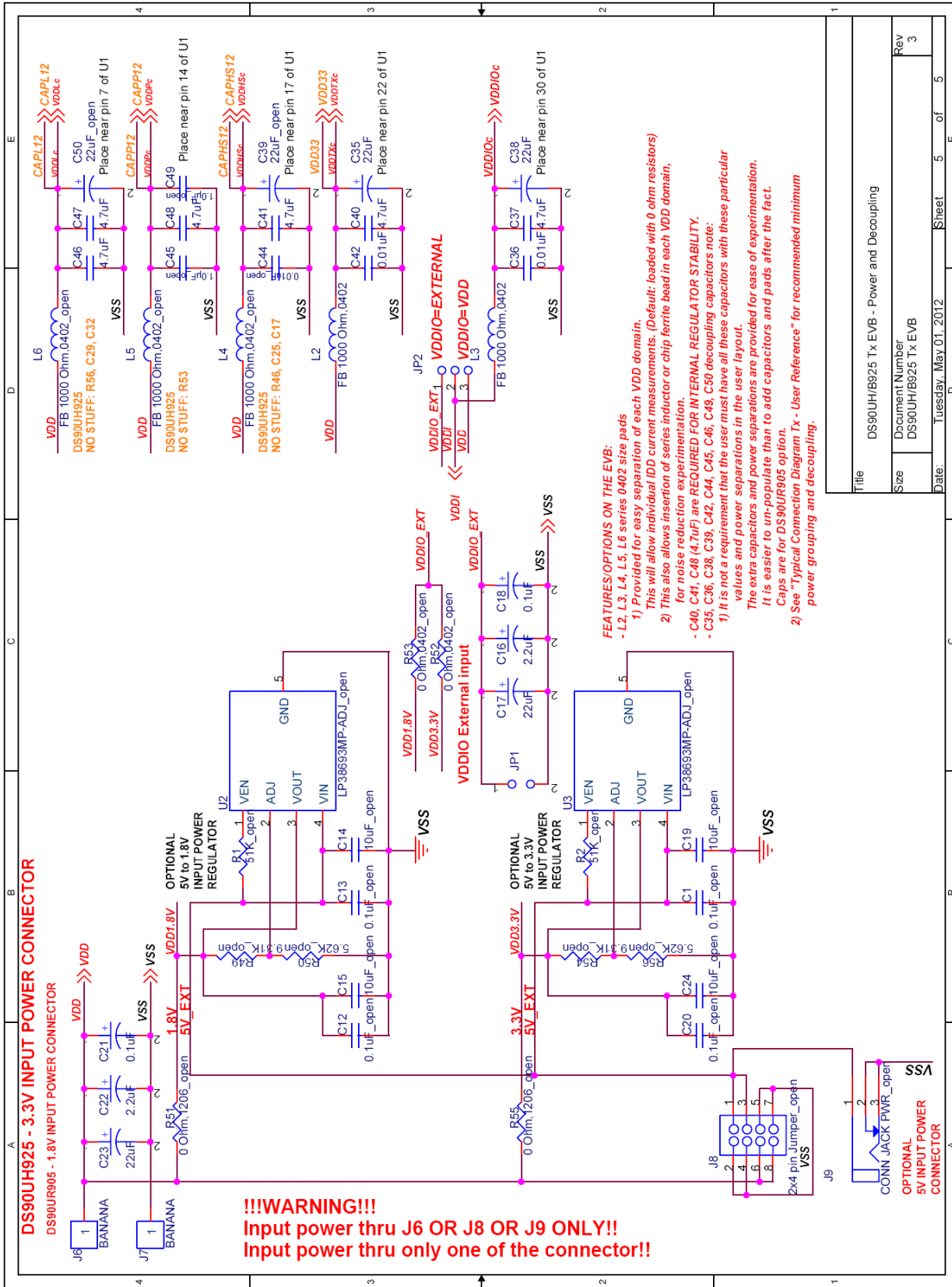

Figure 9: BOTTOM Layer

7. Schematic







Title	DS90UH925 Tx EVB - Power and Decoupling
Size	Document Number DS90UH925 Tx EVB
Date:	Rev 3
	Sheet 5 of 5

Schematic

8. Bill of Materials

DS90UH/B925 Tx EVB		Revision: 3				
Bill Of Materials						
Qty	Reference	Part	PCB Footprint	Comments	MFR	MFR Part#
2	CR2,CR1	TVS - Zener Diode	0603 (1608 metric)	SUPPRESSOR ESD 24VDC 0603 SMD	Littelfuse Inc	PGB1010603MR
5	C2,C28,C29,C30,C32	0.1uF	CAP/HDC-0603	CAP CER .1UF 50V 10% X7R 0603	Murata Electronics North America	GRM188R71H104KA93D
2	C5,C3	0.22uF	CAP/HDC-0603	CAP CER .22UF 50V 5V 0603	TDK Corporation	C1608Y5V1H224Z
1	C4	4.7uF	CAP/3216-18 (EIA) 1206	CAPACITOR TANT 4.7UF 16V 10% SMD	Kemet	T491A475K016AT
2	C6,C7	15pF	CAP/HDC-0603	CAP CERAMIC 15PF 50V NP0 0603	Kemet	C0603C150J5GACTU
4	C8,C9,C10,C27	0.1uF	CAP/HDC-0603	CAP CER .1UF 50V X7R 0603	Murata	GCM188R71H104KA57D
2	C16,C22	2.2uF	3528-21_EIA	CAPACITOR TANT 2.2UF 20V 10% SMD	KEMET	T491B225K020AT
2	C17,C23	22uF	CAP/N	CAP TANTALUM 22UF 25V 20% SMD	nichicon	F931E226MNC
2	C21,C18	0.1uF	CAP/HDC-1206	CAP .10UF 50V CERAMIC X7R 1206	KEMET	C1206C104K5RACTU
2	C25,C26	4.7pF	CAP/HDC-0402	CAP CERAMIC 4.7PF 25V COG 0402	Panasonic	ECD-G0E4R7C
1	C31	0.1uF	CAP/HDC-0603	CAP CER .1UF 50V 10% X7R 0603	Murata Electronics North America	GRM188R71H104KA93Dn
1	C33	1uF	CAP/3216-18 (EIA) 1206	CAPACITOR TANT 1.0UF 16V 10% SMD	Kemet	T491A105K016AT
1	C34	0.033uF	CAP/HDC-0603	CAP CERM 33000PF 5% 50V X7R 0603	AVX Corporation	06035C333JAT2A
3	C35,C38,C53	22uF	CAP/EIA-B 3528-21	CAPACITOR TANT 22UF 16V 20% SMD	Kemet	T494B226M016AT
2	C36,C42	0.01uF	CAP/HDC-0603	CAP CERAMIC .01UF 100V X7R 0603	KEMET	C0603C103K1RACTU
8	C37,C40,C41,C46, C47,C48,C55,C56	4.7uF	CAP/HDC-0805	CAP CER 4.7UF 16V X7R 0805	Murata	490-5332-1-ND
1	D1	LED-super-red	SMT/0805 (2012 Metric)	LED TOPLED 630NM SUP RED CLR SMD	Osram Opto Semiconductors Inc	LS M67K-H2L1-1-0-2-R18-Z
1	D2	5S DIODE	MELF (LL-34)	DIODE HI CONDUCTANCE 100V LL-34	Fairchild Semiconductor Corporation	FDLL4148
3	JP1,JP3,JP13	Header/2P	2-Pin Header	CONN HEADER VERT .100 2POS 30AU	AMP/Tyco	87220-2
1	JP2	Header/3P	3-Pin Header	CONN HEADER VERT .100 3POS 15AU	AMP/Tyco	87224-3
1	JP10	Header/2X10P	Header/2X10P	CONN HEADER VERT .100 20POS 30AU	AMP/TYCO	87215-7
1	J3	mini USB Spin	mini USB surface mount	CONN RECEPT MINI USB2.0 5POS	Hirose	UX60-MB-5ST
1	J4	IDC1x4	IDC-1x4	CONN HEADER 4POS .100 VERT GOLD	Molex/Waldom Electronics Corp	22-11-2042
1	J5	HEADER 28x2	2x28 0.1"	CONN HDR BRKWAY .100 80POS VERT. Cut to fit.	TE Connectivity	9-146261-0
2	J6,J7	BANANA	CON/BANANA-S	BANANA-female (non-insulated)	Johnson	108-0740-001
2	J11,J10	SMA	Edge mount	End Launch Jack Receptacle - Tab Contact	Johnson Components	142-0701-851
1	LED1	0402_orange_LED	0402 SMT	LED ORN/CLEAR 610NM 0402 SMD	Lumex Opto/Components Inc	SML-LX0402SOC-TR
1	L1	Z = 90 ohm	L/HDC-0805	CHOKO COIL COMMON MODE 280MA SMD	Murata	DLW215N900HQ2L
2	L3,L2	FB 1000 Ohm,0402	RES_HDC-0402	FERRITE CHIP 1000 OHM 0402	Murata	BLM15AX1025N1D
2	R3,R4	22_ohm	RES/HDC-0603	RES 22 OHM 1/16W 3300PPM 5% 0603	Panasonic	ERA-V3J220V
2	R5,R11	47Kohm	RES/HDC-0603	RES 47K OHM 1/16W .1% 0603 SMD	Panasonic	ERA-3AEB473V
1	R6	1Kohm	RES/HDC-0603	RES 1.0K OHM 1/16W .1% 0603 SMD	Panasonic	ERA-3AEB102V
6	R8,R9,R57,R58,R59,R150	0ohm	RES/HDC-0603	RES ZERO OHM 1/10W 5% 0603 SMD	Panasonic	ERJ-3GEY0R00V
11	R12,R13,R60,R68,R69,R78, R79,R80,R82,R142,R143	0 Ohm,0402	RES/HDC-0402	RES ZERO OHM 1/16W 5% 0402 SMD	Panasonic	ERJ-2GEJ0R00X
1	R44	0.10 Ohm,0402	RES/HDC-0402	RESISTOR .10 OHM 1/8W 1% 0402	Panasonic	ERJ-2B5FR10X
3	R63,R64,R67	4.7K	RES/HDC-0603	RES 4.7K OHM 1/10W 5% 0603 SMD	Panasonic	ERJ-3GEYJ472V
2	R72,R74	0 ohm	RES/HDC-0201	RES 0.0 OHM 1/20W 5% 0201 SMD	Panasonic	ERJ-1GE0R00C
7	R83,R84,R85,R86,R87,R88, R89	10K	RES/HDC-0603	RES 10.0K OHM 1/10W 1% 0603 SMD	Panasonic	ERJ-3EK1002V
4	R90,R91,R122,R123	40.2K Ohm,0402	RES/HDC-0402	RES 40.2K OHM 1/10W 1% 0402 SMD	Panasonic	ERJ-2RKF4022X
2	R92,R124	49.9K Ohm,0402	RES/HDC-0402	RES 49.9K OHM 1/10W 1% 0402 SMD	Panasonic	ERJ-2RKF4992X
1	R93	60.4K Ohm,0402	RES/HDC-0402	RES 60.4K OHM 1/10W 1% 0402 SMD	Panasonic	ERJ-2RKF6042X
1	R94	71.5K Ohm,0402	RES/HDC-0402	RES 71.5K OHM 1/10W 1% 0402 SMD	Panasonic	ERJ-2RKF7152X
2	R125,R95	76.8K Ohm,0402	RES/HDC-0402	RES 76.8K OHM 1/10W 1% 0402 SMD	Panasonic	ERJ-2RKF7682X
3	R96,R121,R141	90.9K Ohm,0402	RES/HDC-0402	RES 90.9K OHM 1/10W 1% 0402 SMD	Panasonic	ERJ-2RKF9092X
2	R126,R97	102K Ohm,0402	RES/HDC-0402	RES 102K OHM 1/10W 1% 0402 SMD	Panasonic	ERJ-2RKF1023X
1	R98	115K Ohm,0402	RES/HDC-0402	RES 115K OHM 1/10W 1% 0402 SMD	Panasonic	ERJ-2RKF1153X
2	R99,R127	130K Ohm,0402	RES/HDC-0402	RES 130K OHM 1/10W 1% 0402 SMD	Panasonic	ERJ-2RKF1303X
1	R100	147K Ohm,0402	RES/HDC-0402	RES 147K OHM 1/10W 1% 0402 SMD	Panasonic	ERJ-2RKF1473X
2	R101,R128	165K Ohm,0402	RES/HDC-0402	RES 165K OHM 1/10W 1% 0402 SMD	Panasonic	ERJ-2RKF1653X
1	R102	180K Ohm,0402	RES/HDC-0402	RES 180K OHM 1/10W 1% 0402 SMD	Panasonic	ERJ-2RKF1803X
2	R129,R103	191K Ohm,0402	RES/HDC-0402	RES 191K OHM 1/10W 1% 0402 SMD	Panasonic	ERJ-2RKF1913X
3	R104,R114,R130	210K Ohm,0402	RES/HDC-0402	RES 210K OHM 1/10W 1% 0402 SMD	Panasonic	ERJ-2RKF2103X
3	R105,R112,R131	243K Ohm,0402	RES/HDC-0402	RES 243K OHM 1/10W 1% 0402 SMD	Panasonic	ERJ-2RKF2433X
2	R107,R133	294K Ohm,0402	RES/HDC-0402	RES 294K OHM 1/10W 1% 0402 SMD	Panasonic	ERJ-2RKF2943X
2	R134,R108	280K Ohm,0402	RES/HDC-0402	RES 280K OHM 1/10W 1% 0402 SMD	Panasonic	ERJ-2RKF2803X
1	R109	270K Ohm,0402	RES/HDC-0402	RES 270K OHM 1/10W 1% 0402 SMD	Panasonic	ERJ-2RKF2703X
1	R110	267K Ohm,0402	RES/HDC-0402	RES 267K OHM 1/10W 1% 0402 SMD	Panasonic	ERJ-2RKF2673X
2	R135,R111	240K Ohm,0402	RES/HDC-0402	RES 240K OHM 1/10W 1% 0402 SMD	Panasonic	ERJ-2RKF2403X
2	R113,R136	226K Ohm,0402	RES/HDC-0402	RES 226K OHM 1/10W 1% 0402 SMD	Panasonic	ERJ-2RKF2263X
2	R115,R137	196K Ohm,0402	RES/HDC-0402	RES 196K OHM 1/10W 1% 0402 SMD	Panasonic	ERJ-2RKF1963X
1	R116	182K Ohm,0402	RES/HDC-0402	RES 182K OHM 1/10W 1% 0402 SMD	Panasonic	ERJ-2RKF1823X
2	R138,R117	169K Ohm,0402	RES/HDC-0402	RES 169K OHM 1/10W 1% 0402 SMD	Panasonic	ERJ-2RKF1693X
1	R118	154K Ohm,0402	RES/HDC-0402	RES 154K OHM 1/10W 1% 0402 SMD	Panasonic	ERJ-2RKF1543X
2	R119,R139	137K Ohm,0402	RES/HDC-0402	RES 137K OHM 1/10W 1% 0402 SMD	Panasonic	ERJ-2RKF1373X
2	R140,R120	124K Ohm,0402	RES/HDC-0402	RES 124K OHM 1/10W 1% 0402 SMD	Panasonic	ERJ-2RKF1243X
1	R149	47Kohm	RES/HDC-0603	RES 47K OHM 1/10W 5% 0603 SMD	Panasonic	ERJ-3GEYJ473V
2	SW1,SW2	SPST		SWITCH TACT	APMEM Components	ADTSM31NV
1	S1	SW DIP-2	DIP-4	SWITCH DIP EXTENDED SEALED 2POS	Grayhill	78B02ST
2	S2,S3	SW SMD-8	SMD-20	SWITCH TAPE SEAL 8 POS SMD	CTS Electrocomponents	219-8MST
1	S4	SW SMD-10	SMD-20	SWITCH TAPE SEAL 10 POS SMD	CTS Electrocomponents	219-10MST
1	U1	DS90UH/B925Q	48ld TQFP	DO NOT PURCHASE, National will supply.	National	DS90UH925Q or DS90UH925Q
1	U4	AT90 AVR* 8-Bit	64QFN	IC AVR MCU 128K 64QFN	Atmel	AT90USB1287-16MU
1	U5	REG_LDO	SMT/8-MSOP	IC REG LDO 300MA 3.3V 8MSOP	National Semiconductor	LP3982IMM-3.3/NOPB
1	Y1	8MHz CRYSTAL	5.0mm x 3.2mm	CRYSTAL 8.000 MHZ 18PF SMD	Abrakon Corporation	ABM3-8.000MHZ-D2Y-T

Table 1: Bill of Materials

EVALUATION BOARD/KIT/MODULE (EVM) ADDITIONAL TERMS

Texas Instruments (TI) provides the enclosed Evaluation Board/Kit/Module (EVM) under the following conditions: The user assumes all responsibility and liability for proper and safe handling of the goods. Further, the user indemnifies TI from all claims arising from the handling or use of the goods.

Should this evaluation board/kit not meet the specifications indicated in the User's Guide, the board/kit may be returned within 30 days from the date of delivery for a full refund. THE FOREGOING LIMITED WARRANTY IS THE EXCLUSIVE WARRANTY MADE BY SELLER TO BUYER AND IS IN LIEU OF ALL OTHER WARRANTIES, EXPRESSED, IMPLIED, OR STATUTORY, INCLUDING ANY WARRANTY OF MERCHANTABILITY OR FITNESS FOR ANY PARTICULAR PURPOSE. EXCEPT TO THE EXTENT OF THE INDEMNITY SET FORTH ABOVE, NEITHER PARTY SHALL BE LIABLE TO THE OTHER FOR ANY INDIRECT, SPECIAL, INCIDENTAL, OR CONSEQUENTIAL DAMAGES.

Please read the User's Guide and, specifically, the Warnings and Restrictions notice in the User's Guide prior to handling the product. This notice contains important safety information about temperatures and voltages. For additional information on TI's environmental and/or safety programs, please visit www.ti.com/esh or contact TI.

No license is granted under any patent right or other intellectual property right of TI covering or relating to any machine, process, or combination in which such TI products or services might be or are used. TI currently deals with a variety of customers for products, and therefore our arrangement with the user is not exclusive. TI assumes no liability for applications assistance, customer product design, software performance, or infringement of patents or services described herein.

REGULATORY COMPLIANCE INFORMATION

As noted in the EVM User's Guide and/or EVM itself, this EVM and/or accompanying hardware may or may not be subject to the Federal Communications Commission (FCC) and Industry Canada (IC) rules.

For EVMs **not** subject to the above rules, this evaluation board/kit/module is intended for use for ENGINEERING DEVELOPMENT, DEMONSTRATION OR EVALUATION PURPOSES ONLY and is not considered by TI to be a finished end product fit for general consumer use. It generates, uses, and can radiate radio frequency energy and has not been tested for compliance with the limits of computing devices pursuant to part 15 of FCC or ICES-003 rules, which are designed to provide reasonable protection against radio frequency interference. Operation of the equipment may cause interference with radio communications, in which case the user at his own expense will be required to take whatever measures may be required to correct this interference.

General Statement for EVMs including a radio

User Power/Frequency Use Obligations: This radio is intended for development/professional use only in legally allocated frequency and power limits. Any use of radio frequencies and/or power availability of this EVM and its development application(s) must comply with local laws governing radio spectrum allocation and power limits for this evaluation module. It is the user's sole responsibility to only operate this radio in legally acceptable frequency space and within legally mandated power limitations. Any exceptions to this are strictly prohibited and unauthorized by Texas Instruments unless user has obtained appropriate experimental/development licenses from local regulatory authorities, which is responsibility of user including its acceptable authorization.

For EVMs annotated as FCC – FEDERAL COMMUNICATIONS COMMISSION Part 15 Compliant

Caution

This device complies with part 15 of the FCC Rules. Operation is subject to the following two conditions: (1) This device may not cause harmful interference, and (2) this device must accept any interference received, including interference that may cause undesired operation.

Changes or modifications not expressly approved by the party responsible for compliance could void the user's authority to operate the equipment.

FCC Interference Statement for Class A EVM devices

This equipment has been tested and found to comply with the limits for a Class A digital device, pursuant to part 15 of the FCC Rules. These limits are designed to provide reasonable protection against harmful interference when the equipment is operated in a commercial environment. This equipment generates, uses, and can radiate radio frequency energy and, if not installed and used in accordance with the instruction manual, may cause harmful interference to radio communications. Operation of this equipment in a residential area is likely to cause harmful interference in which case the user will be required to correct the interference at his own expense.

FCC Interference Statement for Class B EVM devices

This equipment has been tested and found to comply with the limits for a Class B digital device, pursuant to part 15 of the FCC Rules. These limits are designed to provide reasonable protection against harmful interference in a residential installation. This equipment generates, uses and can radiate radio frequency energy and, if not installed and used in accordance with the instructions, may cause harmful interference to radio communications. However, there is no guarantee that interference will not occur in a particular installation. If this equipment does cause harmful interference to radio or television reception, which can be determined by turning the equipment off and on, the user is encouraged to try to correct the interference by one or more of the following measures:

- Reorient or relocate the receiving antenna.
- Increase the separation between the equipment and receiver.
- Connect the equipment into an outlet on a circuit different from that to which the receiver is connected.
- Consult the dealer or an experienced radio/TV technician for help.

For EVMs annotated as IC – INDUSTRY CANADA Compliant

This Class A or B digital apparatus complies with Canadian ICES-003.

Changes or modifications not expressly approved by the party responsible for compliance could void the user's authority to operate the equipment.

Concerning EVMs including radio transmitters

This device complies with Industry Canada licence-exempt RSS standard(s). Operation is subject to the following two conditions: (1) this device may not cause interference, and (2) this device must accept any interference, including interference that may cause undesired operation of the device.

Concerning EVMs including detachable antennas

Under Industry Canada regulations, this radio transmitter may only operate using an antenna of a type and maximum (or lesser) gain approved for the transmitter by Industry Canada. To reduce potential radio interference to other users, the antenna type and its gain should be so chosen that the equivalent isotropically radiated power (e.i.r.p.) is not more than that necessary for successful communication.

This radio transmitter has been approved by Industry Canada to operate with the antenna types listed in the user guide with the maximum permissible gain and required antenna impedance for each antenna type indicated. Antenna types not included in this list, having a gain greater than the maximum gain indicated for that type, are strictly prohibited for use with this device.

Cet appareil numérique de la classe A ou B est conforme à la norme NMB-003 du Canada.

Les changements ou les modifications pas expressément approuvés par la partie responsable de la conformité ont pu vider l'autorité de l'utilisateur pour actionner l'équipement.

Concernant les EVMs avec appareils radio

Le présent appareil est conforme aux CNR d'Industrie Canada applicables aux appareils radio exempts de licence. L'exploitation est autorisée aux deux conditions suivantes : (1) l'appareil ne doit pas produire de brouillage, et (2) l'utilisateur de l'appareil doit accepter tout brouillage radioélectrique subi, même si le brouillage est susceptible d'en compromettre le fonctionnement.

Concernant les EVMs avec antennes détachables

Conformément à la réglementation d'Industrie Canada, le présent émetteur radio peut fonctionner avec une antenne d'un type et d'un gain maximal (ou inférieur) approuvé pour l'émetteur par Industrie Canada. Dans le but

de réduire les risques de brouillage radioélectrique à l'intention des autres utilisateurs, il faut choisir le type d'antenne et son gain de sorte que la puissance isotrope rayonnée équivalente (p.i.r.e.) ne dépasse pas l'intensité nécessaire à l'établissement d'une communication satisfaisante.

Le présent émetteur radio a été approuvé par Industrie Canada pour fonctionner avec les types d'antenne énumérés dans le manuel d'usage et ayant un gain admissible maximal et l'impédance requise pour chaque type d'antenne. Les types d'antenne non inclus dans cette liste, ou dont le gain est supérieur au gain maximal indiqué, sont strictement interdits pour l'exploitation de l'émetteur.

[Important Notice for Users of this Product in Japan]

This development kit is NOT certified as Confirming to Technical Regulations of Radio Law of Japan

If you use this product in Japan, you are required by Radio Law of Japan to follow the instructions below with respect to this product:

1. Use this product in a shielded room or any other test facility as defined in the notification #173 issued by Ministry of Internal Affairs and Communications on March 28, 2006, based on Sub-section 1.1 of Article 6 of the Ministry's Rule for Enforcement of Radio Law of Japan,
2. Use this product only after you obtained the license of Test Radio Station as provided in Radio Law of Japan with respect to this product, or
3. Use of this product only after you obtained the Technical Regulations Conformity Certification as provided in Radio Law of Japan with respect to this product. Also, please do not transfer this product, unless you give the same notice above to the transferee. Please note that if you could not follow the instructions above, you will be subject to penalties of Radio Law of Japan.

Texas Instruments Japan Limited
(address) 24-1, Nishi-Shinjuku 6 chome, Shinjuku-ku, Tokyo, Japan

<http://www.tij.co.jp>

【ご使用にあたっての注】

本開発キットは技術基準適合証明を受けておりません。

本製品のご使用に際しては、電波法遵守のため、以下のいずれかの措置を取っていただく必要がありますのでご注意ください。

1. 電波法施行規則第6条第1項第1号に基づく平成18年3月28日総務省告示第173号で定められた電波暗室等の試験設備でご使用いただく。
2. 実験局の免許を取得後ご使用いただく。
3. 技術基準適合証明を取得後ご使用いただく。

なお、本製品は、上記の「ご使用にあたっての注意」を譲渡先、移転先に通知しない限り、譲渡、移転できないものとします。

上記を遵守頂けない場合は、電波法の罰則が適用される可能性があることをご留意ください。

日本テキサス・インスツルメンツ株式会社

東京都新宿区西新宿6丁目24番1号

西新宿三井ビル

<http://www.tij.co.jp>

EVALUATION BOARD/KIT/MODULE (EVM) WARNINGS, RESTRICTIONS AND DISCLAIMERS

For Feasibility Evaluation Only, in Laboratory/Development Environments. Unless otherwise indicated, this EVM is not a finished electrical equipment and not intended for consumer use. It is intended solely for use for preliminary feasibility evaluation in laboratory/development environments by technically qualified electronics experts who are familiar with the dangers and application risks associated with handling electrical mechanical components, systems and subsystems. It should not be used as all or part of a finished end product.

Your Sole Responsibility and Risk. You acknowledge, represent and agree that:

1. You have unique knowledge concerning Federal, State and local regulatory requirements (including but not limited to Food and Drug Administration regulations, if applicable) which relate to your products and which relate to your use (and/or that of your employees, affiliates, contractors or designees) of the EVM for evaluation, testing and other purposes.
2. You have full and exclusive responsibility to assure the safety and compliance of your products with all such laws and other applicable regulatory requirements, and also to assure the safety of any activities to be conducted by you and/or your employees, affiliates, contractors or designees, using the EVM. Further, you are responsible to assure that any interfaces (electronic and/or mechanical) between the EVM and any human body are designed with suitable isolation and means to safely limit accessible leakage currents to minimize the risk of electrical shock hazard.
3. You will employ reasonable safeguards to ensure that your use of the EVM will not result in any property damage, injury or death, even if the EVM should fail to perform as described or expected.
4. You will take care of proper disposal and recycling of the EVM's electronic components and packing materials.

Certain Instructions. It is important to operate this EVM within TI's recommended specifications and environmental considerations per the user guidelines. Exceeding the specified EVM ratings (including but not limited to input and output voltage, current, power, and environmental ranges) may cause property damage, personal injury or death. If there are questions concerning these ratings please contact a TI field representative prior to connecting interface electronics including input power and intended loads. Any loads applied outside of the specified output range may result in unintended and/or inaccurate operation and/or possible permanent damage to the EVM and/or interface electronics. Please consult the EVM User's Guide prior to connecting any load to the EVM output. If there is uncertainty as to the load specification, please contact a TI field representative. During normal operation, some circuit components may have case temperatures greater than 60°C as long as the input and output are maintained at a normal ambient operating temperature. These components include but are not limited to linear regulators, switching transistors, pass transistors, and current sense resistors which can be identified using the EVM schematic located in the EVM User's Guide. When placing measurement probes near these devices during normal operation, please be aware that these devices may be very warm to the touch. As with all electronic evaluation tools, only qualified personnel knowledgeable in electronic measurement and diagnostics normally found in development environments should use these EVMs.

Agreement to Defend, Indemnify and Hold Harmless. You agree to defend, indemnify and hold TI, its licensors and their representatives harmless from and against any and all claims, damages, losses, expenses, costs and liabilities (collectively, "Claims") arising out of or in connection with any use of the EVM that is not in accordance with the terms of the agreement. This obligation shall apply whether Claims arise under law of tort or contract or any other legal theory, and even if the EVM fails to perform as described or expected.

Safety-Critical or Life-Critical Applications. If you intend to evaluate the components for possible use in safety critical applications (such as life support) where a failure of the TI product would reasonably be expected to cause severe personal injury or death, such as devices which are classified as FDA Class III or similar classification, then you must specifically notify TI of such intent and enter into a separate Assurance and Indemnity Agreement.

IMPORTANT NOTICE

Texas Instruments Incorporated and its subsidiaries (TI) reserve the right to make corrections, enhancements, improvements and other changes to its semiconductor products and services per JESD46, latest issue, and to discontinue any product or service per JESD48, latest issue. Buyers should obtain the latest relevant information before placing orders and should verify that such information is current and complete. All semiconductor products (also referred to herein as "components") are sold subject to TI's terms and conditions of sale supplied at the time of order acknowledgment.

TI warrants performance of its components to the specifications applicable at the time of sale, in accordance with the warranty in TI's terms and conditions of sale of semiconductor products. Testing and other quality control techniques are used to the extent TI deems necessary to support this warranty. Except where mandated by applicable law, testing of all parameters of each component is not necessarily performed.

TI assumes no liability for applications assistance or the design of Buyers' products. Buyers are responsible for their products and applications using TI components. To minimize the risks associated with Buyers' products and applications, Buyers should provide adequate design and operating safeguards.

TI does not warrant or represent that any license, either express or implied, is granted under any patent right, copyright, mask work right, or other intellectual property right relating to any combination, machine, or process in which TI components or services are used. Information published by TI regarding third-party products or services does not constitute a license to use such products or services or a warranty or endorsement thereof. Use of such information may require a license from a third party under the patents or other intellectual property of the third party, or a license from TI under the patents or other intellectual property of TI.

Reproduction of significant portions of TI information in TI data books or data sheets is permissible only if reproduction is without alteration and is accompanied by all associated warranties, conditions, limitations, and notices. TI is not responsible or liable for such altered documentation. Information of third parties may be subject to additional restrictions.

Resale of TI components or services with statements different from or beyond the parameters stated by TI for that component or service voids all express and any implied warranties for the associated TI component or service and is an unfair and deceptive business practice. TI is not responsible or liable for any such statements.

Buyer acknowledges and agrees that it is solely responsible for compliance with all legal, regulatory and safety-related requirements concerning its products, and any use of TI components in its applications, notwithstanding any applications-related information or support that may be provided by TI. Buyer represents and agrees that it has all the necessary expertise to create and implement safeguards which anticipate dangerous consequences of failures, monitor failures and their consequences, lessen the likelihood of failures that might cause harm and take appropriate remedial actions. Buyer will fully indemnify TI and its representatives against any damages arising out of the use of any TI components in safety-critical applications.

In some cases, TI components may be promoted specifically to facilitate safety-related applications. With such components, TI's goal is to help enable customers to design and create their own end-product solutions that meet applicable functional safety standards and requirements. Nonetheless, such components are subject to these terms.

No TI components are authorized for use in FDA Class III (or similar life-critical medical equipment) unless authorized officers of the parties have executed a special agreement specifically governing such use.

Only those TI components which TI has specifically designated as military grade or "enhanced plastic" are designed and intended for use in military/aerospace applications or environments. Buyer acknowledges and agrees that any military or aerospace use of TI components which have **not** been so designated is solely at the Buyer's risk, and that Buyer is solely responsible for compliance with all legal and regulatory requirements in connection with such use.

TI has specifically designated certain components which meet ISO/TS16949 requirements, mainly for automotive use. Components which have not been so designated are neither designed nor intended for automotive use; and TI will not be responsible for any failure of such components to meet such requirements.

Products

Audio	www.ti.com/audio
Amplifiers	amplifier.ti.com
Data Converters	dataconverter.ti.com
DLP® Products	www.dlp.com
DSP	dsp.ti.com
Clocks and Timers	www.ti.com/clocks
Interface	interface.ti.com
Logic	logic.ti.com
Power Mgmt	power.ti.com
Microcontrollers	microcontroller.ti.com
RFID	www.ti-rfid.com
OMAP Applications Processors	www.ti.com/omap
Wireless Connectivity	www.ti.com/wirelessconnectivity

Applications

Automotive and Transportation	www.ti.com/automotive
Communications and Telecom	www.ti.com/communications
Computers and Peripherals	www.ti.com/computers
Consumer Electronics	www.ti.com/consumer-apps
Energy and Lighting	www.ti.com/energy
Industrial	www.ti.com/industrial
Medical	www.ti.com/medical
Security	www.ti.com/security
Space, Avionics and Defense	www.ti.com/space-avionics-defense
Video and Imaging	www.ti.com/video

TI E2E Community

e2e.ti.com