



ABSTRACT

This user's guide describes the TPS2583xA-Q1 evaluation module (TPS2583XAQ1EVM-147). This document contains the EVM schematics, EVM configuration, bill of materials (BOM), board layout drawing and assembly drawing.

Table of Contents

1 Introduction	2
1.1 Features.....	2
1.2 Applications.....	2
2 Schematic	3
3 General Configuration and Description	4
3.1 Physical Access.....	4
3.2 Adjusting the Switching Frequency.....	4
3.3 Adjusting the Current Limit Value.....	5
3.4 Adjusting the Cable Compensation Value.....	5
3.5 Test Setup.....	5
4 Board Layout	6
5 Bill of Materials	10

List of Figures

Figure 2-1. TPS2583XAQ1EVM-147 Schematic.....	3
Figure 3-1. EVM Setup for Charging USB Type-C® Device.....	5
Figure 4-1. Top Side Assembly.....	6
Figure 4-2. Bottom Side Assembly.....	6
Figure 4-3. Top Side 3D View.....	7
Figure 4-4. Bottom Side 3D View.....	7
Figure 4-5. Top Layer Layout.....	8
Figure 4-6. Middle Layer 1 Layout.....	8
Figure 4-7. Middle Layer 2 Layout.....	9
Figure 4-8. Bottom Layer Layout.....	9

List of Tables

Table 3-1. Connectors.....	4
Table 3-2. Jumpers.....	4
Table 3-3. LED.....	4
Table 3-4. Test Points.....	4
Table 5-1. Bill of Materials.....	10

Trademarks

USB Type-C® are registered trademarks of USB Implementers Forum.
All trademarks are the property of their respective owners.

1 Introduction

The TPS2583XAQ1EVM-147 is an evaluation module (EVM) for TI's TPS2583xA-Q1 USB Type-C® and BC1.2 5-V, 3.5-A output and 36-V input synchronous buck with cable compensation. The EVM operates over a range from 6 V to 36 V and provides USB Type-C connectors to evaluate BC1.2, USB Type-C charging and USB2.0 data communication functions. The value of cable compensation, current limit and switching frequency can be adjusted by resistors on the EVM.

1.1 Features

The following features are available on this EVM:

- 6-V to 36-V input range, 3.5-A continuous output current buck converter
- Forced PWM operation with *Spread-Spectrum Dithering*
- Fully AEC-Q100 qualified
- $\pm 8\%$ *Current Sense Accuracy* ($I_{OUT} > 1.5\text{ A}$) for *Precision Cable Droop Compensation*
- USB battery charging specification Rev. 1.2 and USB Type-C Rev. 1.3 compliant
- CC1, CC2, D+ and D– Short-to-VBAT, and VBUS protection
- User-programmable VBUS current limit and internal VCONN current limiting
- High bandwidth DP, DM USB switches

1.2 Applications

The EVM is used in the following applications:

- Automotive: Infotainment, USB hubs, aftermarket USB chargers

3 General Configuration and Description

This section describes the connectors, jumpers, LED and test points on the EVM and how to properly connect, set up and use the TPS2583XAQ1EVM-147.

3.1 Physical Access

[Table 3-1](#) lists the TPS2583XAQ1EVM-147 connector functionality, [Table 3-2](#) describes the jumper configuration, [Table 3-3](#) shows LED labels and description and [Table 3-4](#) describes the test point availability.

Table 3-1. Connectors

Connector	Component Type	Description
J1	Terminal block	Power input connector for TPS2583xA-Q1. Connect to a 6-V to 36-V power supply.
J4	USB Type-A connector, plug	Upstream facing USB 2.0 Type A connector. Connect to the USB 2.0 host for data pass through to J4 or J8. The power pin of this connector is float.
J3	USB Type-C connector, receptacle	Downstream facing USB Type-C connector. Connect to the USB Type-C slave for data pass through from J4 and BC1.2 or USB Type-C identification. USB output power is provided to the slave from the buck converter of the TPS2583xA-Q1 device.

Table 3-2. Jumpers

Jumper	Label	Description
J5	CC1	3 × 1 header. Install shunt to connect Ra or Rd on CC1. Remove shunt to float CC1.
J6	CC2	3 × 1 header. Install shunt to connect Ra or Rd on CC2. Remove shunt to float CC2.
J7	CTRL1	Install shunt to select CTRL1 as LOW. Remove shunt to select CTRL1 as HIGH.
	CTRL2	Install shunt to select CTRL2 as LOW. Remove shunt to select CTRL2 as HIGH.

Table 3-3. LED

LED	Label	Description
D4	LD_DET	LD_DET signal LED. Turn on when LD_DET asserts.
D5	POL	POL signal LED. Turn on when POL asserts.
D6	FAULT	FAULT signal LED. Turn on when FAULT asserts.

Table 3-4. Test Points

Test Point	Label	Description
TP1	VCONN	VCC pin test point via R1 or external Vconn input
TP2	CSP	Test point of voltage between inductor and sense resistor
TP3	CSN/OUT	CSN pin test point and DC-DC output test point
TP4	RT	RT pin test point or external clock input
TP5, TP6	GND	Power ground test point
TP7	VBUS	USB Type-A and USB Type-C connector, VBUS test point
TP8	CC1	CC1 pin test point
TP9	CC2	CC2 pin test point
TP10	LD_DET	LD_DET pin test point
TP11	POL	POL pin test point
TP12	FAULT	FAULT pin test point
EN1	EN	EN pin test point or external EN input

3.2 Adjusting the Switching Frequency

If other frequencies are desired, within the frequency range of 400 kHz to 2.2 MHz, the R_t resistor (R12) value can be changed. Consult the data sheet for proper selection of the R_t resistor (R12). Change the inductor (L1) and the total output capacitance for proper control loop operation.

The RT/SYNC pin can also be used to synchronize the internal oscillator to an external clock. The TPS2583XAQ1EVM-147 allows users to synchronize the internal oscillator to both Lo-Z clock source and Hi-Z clock source by configuring R10, R12, and C15. Refer to the data sheet for detailed information.

3.3 Adjusting the Current Limit Value

If other current limit values are desired, the R_i resistor (R13) value can be changed. Consult the data sheet for proper selection of the R_i resistor (R13).

3.4 Adjusting the Cable Compensation Value

If other cable compensation values are desired, the R_m resistor (R14) value can be changed. Consult the data sheet for proper selection of the R_m resistor (R14).

3.5 Test Setup

Figure 3-1 shows a typical test setup for charging the USB Type-C device. Connect J1 to the 13.5-V power supply. Connect USB Type-C device to J3 connector. Shunts do not need to be installed on J5 or J6.

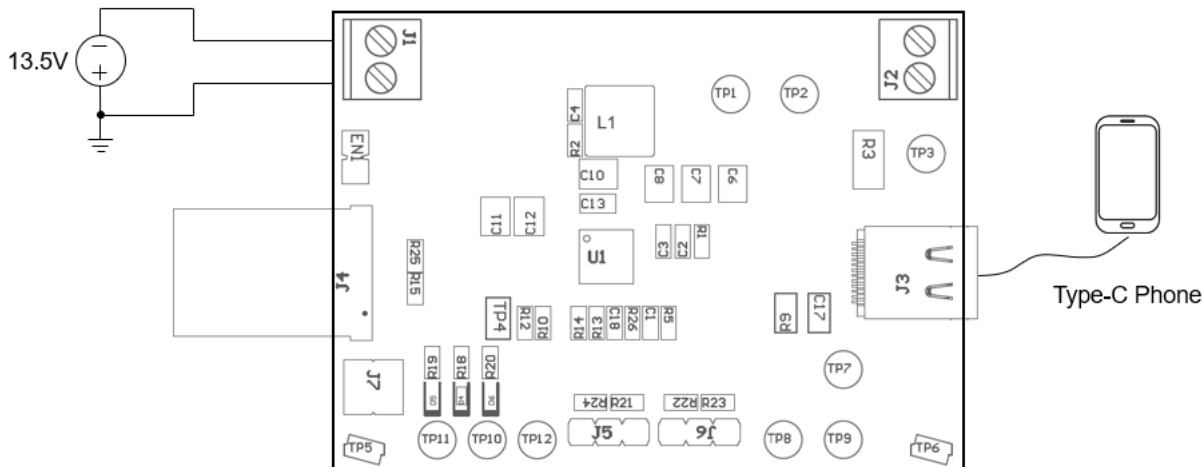

Figure 3-1. EVM Setup for Charging USB Type-C® Device

4 Board Layout

Figure 4-1 and Figure 4-2 show the top and bottom assembly. Figure 4-3 and Figure 4-4 show the top side and bottom side 3D view. Figure 4-5 to Figure 4-8 show the layout of the EVM.

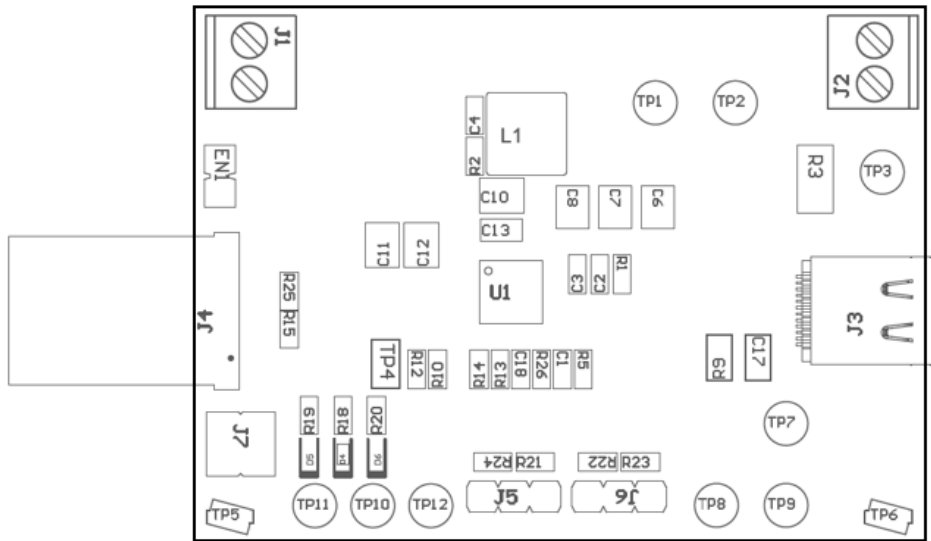

Figure 4-1. Top Side Assembly

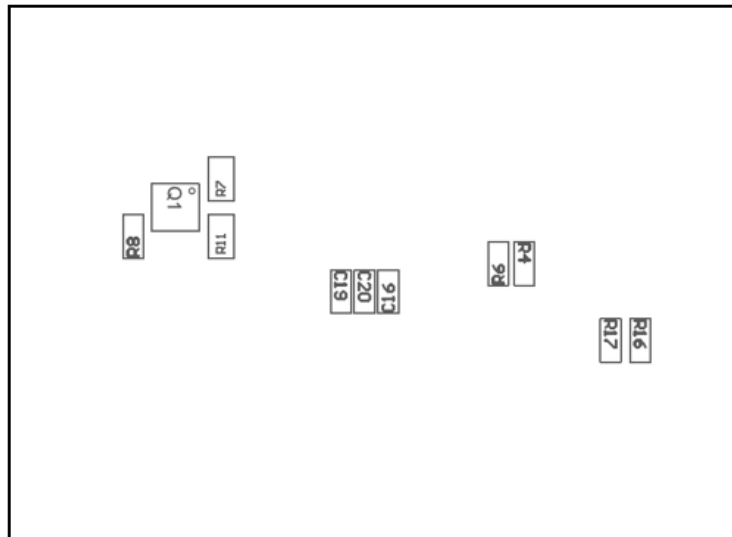

Figure 4-2. Bottom Side Assembly

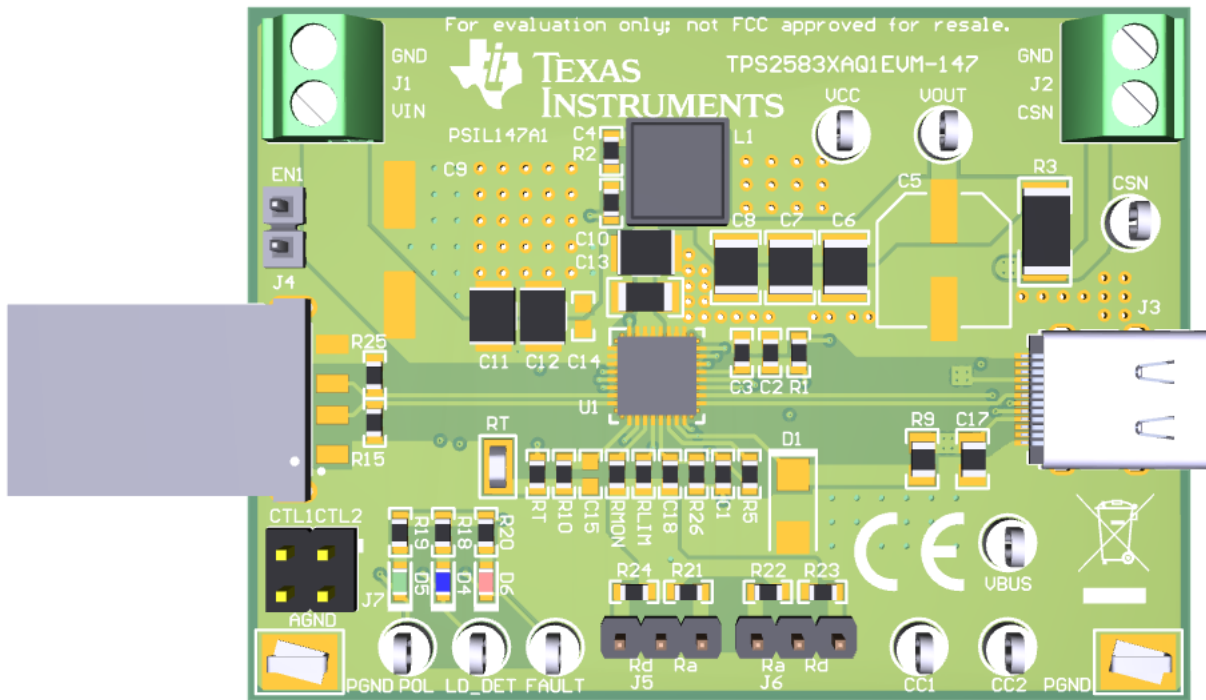

Figure 4-3. Top Side 3D View

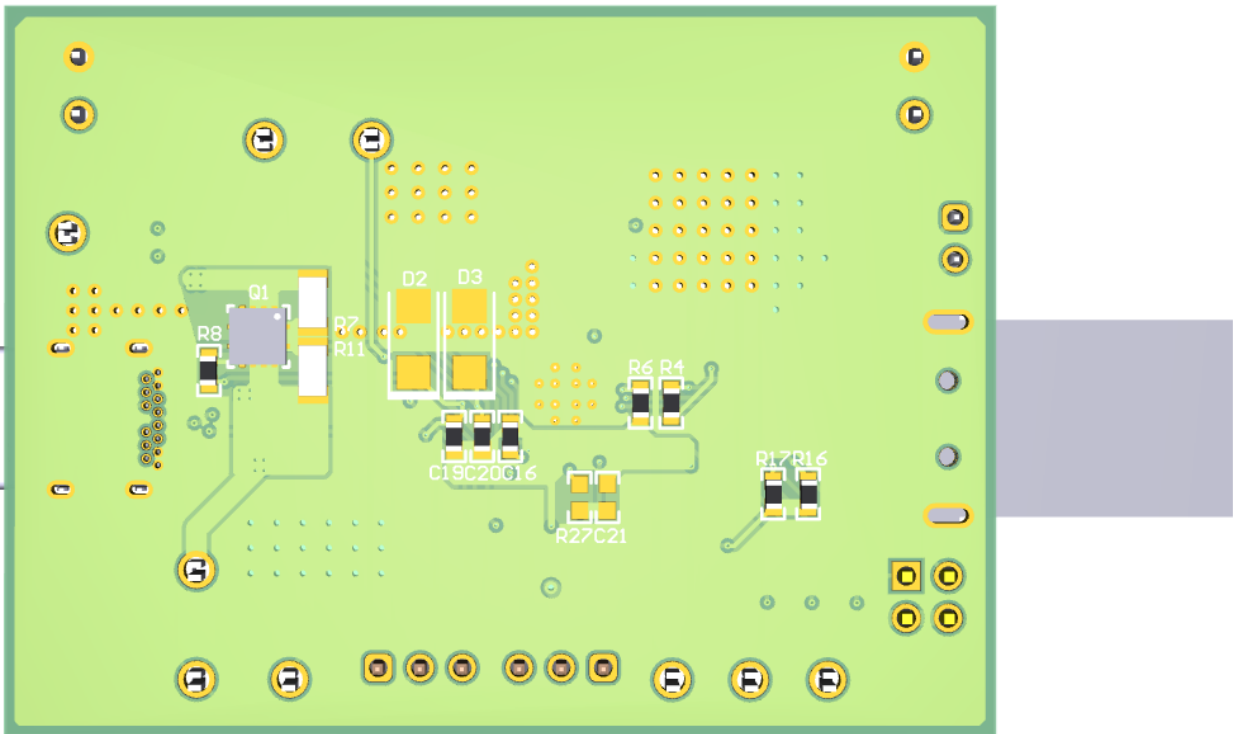

Figure 4-4. Bottom Side 3D View

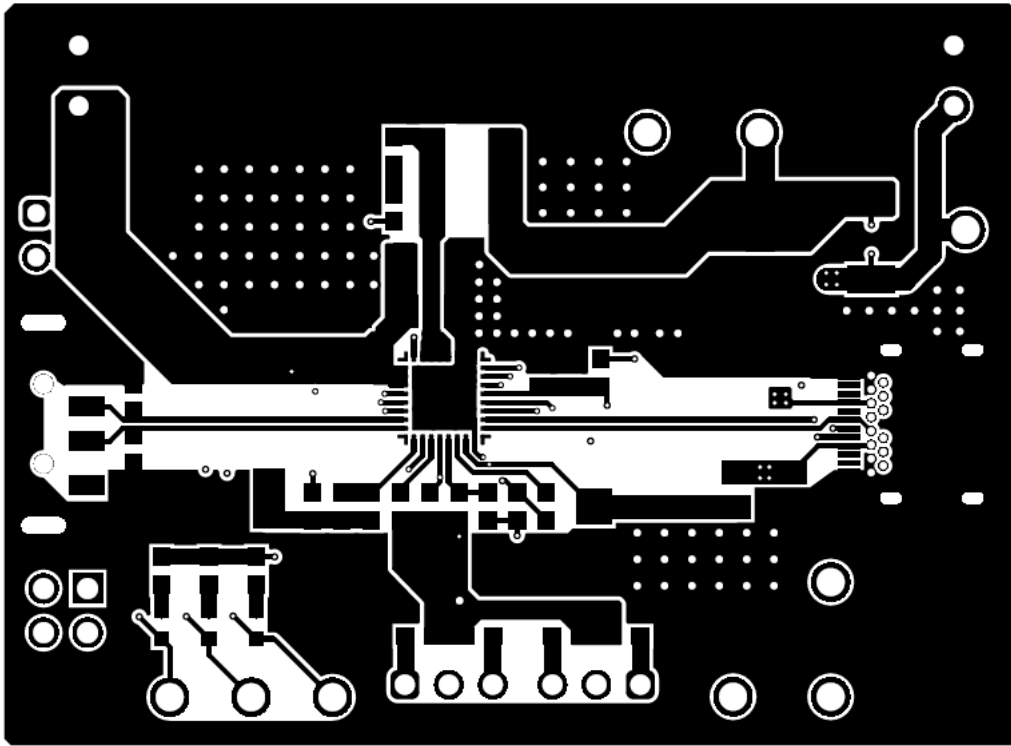

Figure 4-5. Top Layer Layout

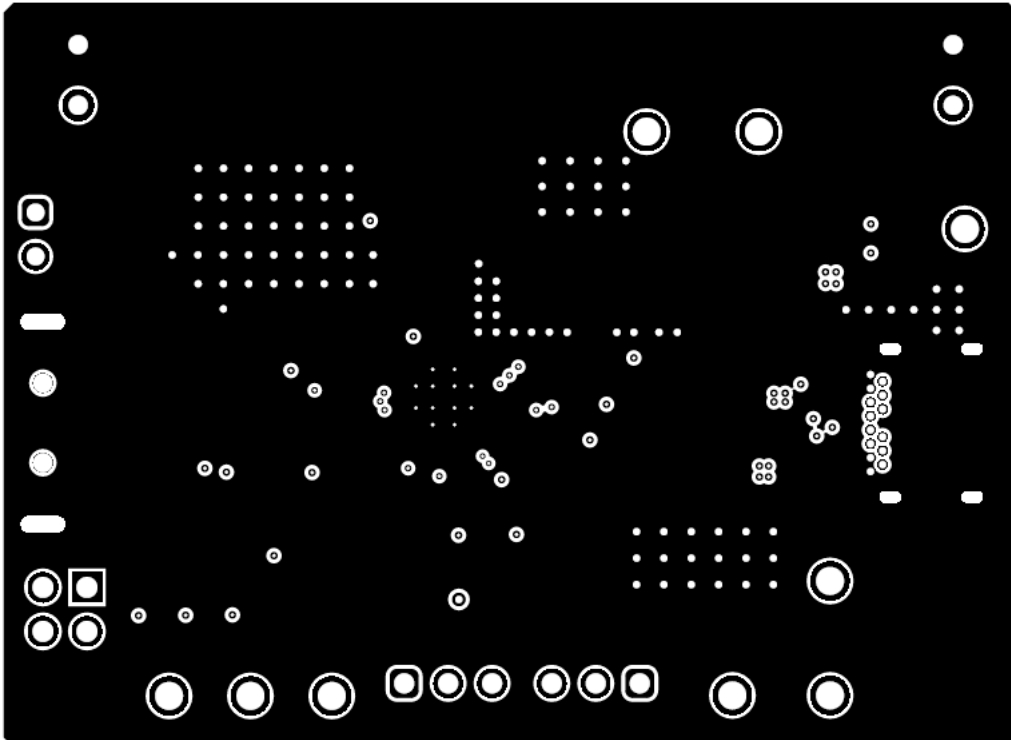

Figure 4-6. Middle Layer 1 Layout

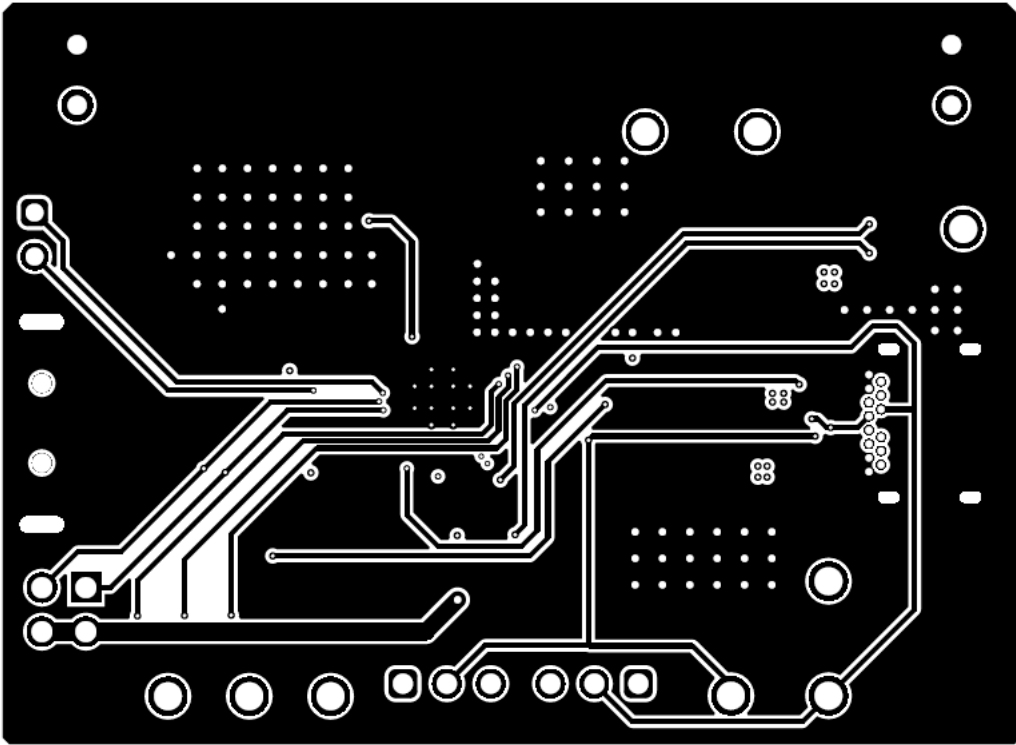

Figure 4-7. Middle Layer 2 Layout

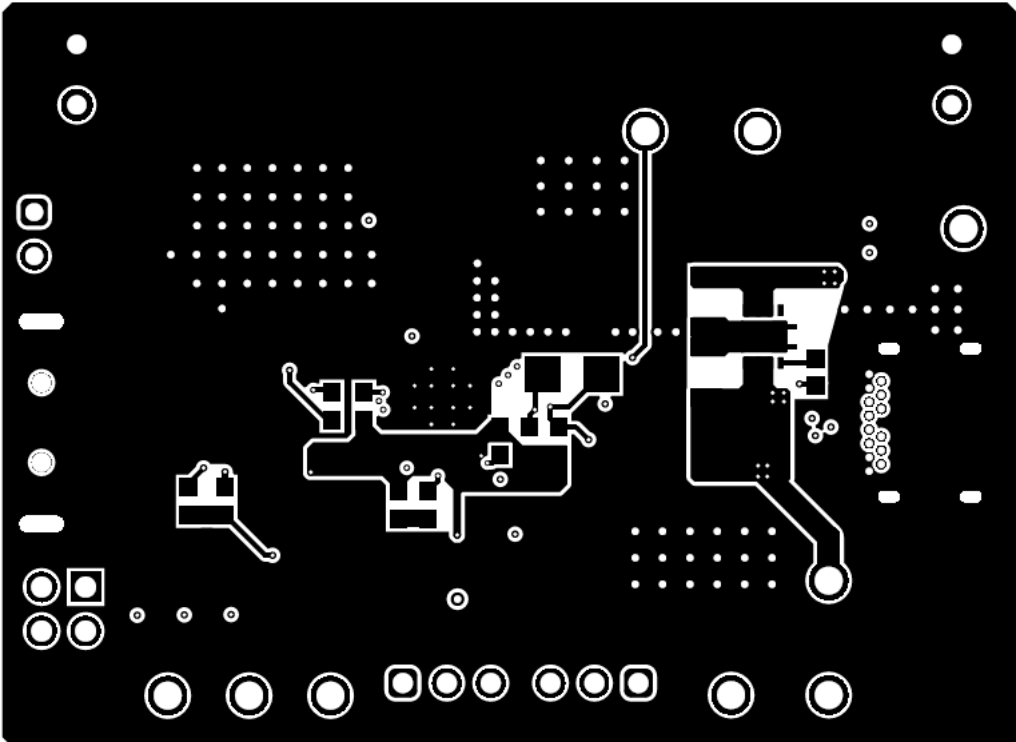

Figure 4-8. Bottom Layer Layout

5 Bill of Materials

Table 5-1 details the EVM bill of materials.

Table 5-1. Bill of Materials

Designator	QTY	Value	Description	Package Reference	Part Number	Manufacturer
C1, C3, C4, C18	4	0.1uF	CAP, CERM, 0.1 μ F, 50 V,+/- 10%, X7R, AEC-Q200 Grade 1, 0603	0603	C0603C104K5RACAUTO	Kemet
C2	1	2.2uF	CAP, CERM, 2.2 μ F, 16 V, +/- 20%, X5R, 0603	0603	885012106018	Wurth Elektronik
C6, C7, C8	3	22uF	CAP, CERM, 22 μ F, 25 V,+/- 10%, X7R, 1210	1210	CL32B226KAJNFNE	Samsung Electro-Mechanics
C10, C11, C12	3	10uF	CAP, CERM, 10 μ F, 50 V,+/- 20%, X7R, AEC-Q200 Grade 1, 1210	1210	UMJ325KB7106MMHP	Taiyo Yuden
C13	1	0.1uF	CAP, CERM, 0.1 μ F, 50 V, +/- 5%, X7R, 1206	1206	12065C104JAT2A	AVX
C16, C19, C20	3	0.22uF	CAP, CERM, 0.22 μ F, 16 V,+/- 10%, X7R, AEC-Q200 Grade 1, 0603	0603	CL10B224K08VPNC	Samsung
C17	1	10uF	CAP, CERM, 10 μ F, 25 V, +/- 10%, X5R, 0805	0805	C2012X5R1E106K125AB	TDK
D4	1	Blue	LED, Blue, SMD	LED_0603	150060BS75000	Wurth Elektronik
D5	1	Green	LED, Green, SMD	LED_0603	150060GS75000	Wurth Elektronik
D6	1	Red	LED, Red, SMD	LED_0603	150060RS75000	Wurth Elektronik
EN1	1		Header, 2.54 mm, 2x1, Tin, TH	Header, 2.54 mm, 2x1, TH	TSW-102-07-T-S	Samtec
J1, J2	2		Conn Term Block, 2POS, 3.5mm, TH	11x8.5x7.3mm	1751248	Phoenix Contact
J3	1		Connector, Receptacle, USB Type C, R/A	Connector, Receptacle, USB Type C, R/A, THT/SMT	632723300011	Wurth Elektronik
J4	1		Connector, Plug, USB Type A, R/A, Top Mount SMT	USB 2.0, SMT Plug, 18.65x4.5x12mm	931	Keystone
J5, J6	2		Header, 2.54 mm, 3x1, Gold, TH	Header, 2.54mm, 3x1, TH	61300311121	Wurth Elektronik
J7	1		Header, 2.54mm, 2x2, Gold, TH	Header, 2.54mm, 2x2, TH	PBC02DAAN	Sullins Connector Solutions
L1	1	8.2uH	Inductor, Shielded, Hyperflux, 8.2 μ H, 5.3 A, 0.0253 ohm, SMD	6.65x6.45mm	74439346082	Wurth Elektronik
Q1	1	20V	MOSFET, 2-CH, N-CH, 20 V, 12 A, DPA0008A (VSON-8)	DPA0008A	CSD85312Q3E	Texas Instruments
R1, R2, R8, R10, R26	5	0	RES, 0, 1%, 0.1 W, AEC-Q200 Grade 0, 0603	0603	RMCF0603ZT0R00	Stackpole Electronics Inc
R3	1	0.015	RES, 0.015, 1%, 0.5 W, 2010	2010	WSL2010R0150FEA	Vishay-Dale
R4, R6	2	20k	RES, 20 k, 5%, 0.1 W, AEC-Q200 Grade 0, 0603	0603	CRCW060320K0JNEA	Vishay-Dale
R5	1	301	RES, 301, 1%, 0.1 W, AEC-Q200 Grade 0, 0603	0603	CRCW0603301RFKEA	Vishay-Dale
R7, R11	2	0	RES, 0, 1%, 0.5 W, 1206	1206	5108	Keystone
R9	1	10.0	RES, 10.0, 1%, 0.125 W, AEC-Q200 Grade 0, 0805	0805	CRCW080510R0FKEA	Vishay-Dale
R12	1	49.9k	RES, 49.9 k, 1%, 0.1 W, AEC-Q200 Grade 0, 0603	0603	CRCW060349K9FKEA	Vishay-Dale
R13, R14	2	5.62k	RES, 5.62 k, 1%, 0.1 W, AEC-Q200 Grade 0, 0603	0603	CRCW06035K62FKEA	Vishay-Dale
R15, R25	2	15.0k	RES, 15.0 k, 1%, 0.1 W, AEC-Q200 Grade 0, 0603	0603	CRCW060315K0FKEA	Vishay-Dale
R16, R17	2	100k	RES, 100 k, 1%, 0.1 W, AEC-Q200 Grade 0, 0603	0603	CRCW0603100KFKEA	Vishay-Dale
R18, R19, R20	3	10k	RES, 10 k, 5%, 0.1 W, AEC-Q200 Grade 0, 0603	0603	CRCW060310K0JNEA	Vishay-Dale
R21, R22	2	1.0k	RES, 1.0 k, 5%, 0.1 W, AEC-Q200 Grade 0, 0603	0603	CRCW06031K00JNEA	Vishay-Dale
R23, R24	2	5.1k	RES, 5.1 k, 5%, 0.1 W, AEC-Q200 Grade 0, 0603	0603	CRCW06035K10JNEA	Vishay-Dale

Table 5-1. Bill of Materials (continued)

Designator	QTY	Value	Description	Package Reference	Part Number	Manufacturer
TP1, TP2, TP3, TP7, TP8, TP9, TP10, TP11, TP12	9		Test Point, Multipurpose, White, TH	White Multipurpose Testpoint	5012	Keystone
TP4	1		Test Point, Miniature, SMT	Testpoint_Keystone_Minature	5015	Keystone
TP5, TP6	2		Test Point, Compact, SMT	Testpoint_Keystone_Compact	5016	Keystone
U1	1		USB Type-C and BC1.2 5V 3.5A Output, 36V Input Synchronous Buck with Cable Compensation, RHB0032R (VQFN-32)	RHB0032R	TPS25830S10QWRHB	Texas Instruments
C5	0	47uF	CAP, AL, 47 uF, 25 V, +/- 20%, 0.4 ohm, SMD	SMT Radial E	EEE-FC1E470P	Panasonic
C9	0	100uF	CAP, AL, 100 µF, 50 V, +/- 20%, SMD	D8xL10.5mm	865060653010	Würth Elektronik
C14, C15	0	0.1uF	CAP, CERM, 0.1 µF, 50 V, +/- 10%, X7R, AEC-Q200 Grade 1, 0603	0603	C0603C104K5RACAUTO	Kemet
C21	0	0.1uF	CAP, CERM, 0.1 uF, 16 V, +/- 10%, X7R, 0603	0603	CL10B104K08NNNC	Samsung Electro-Mechanics
D1, D2, D3	0	18V	Diode, TVS, Uni, 18 V, 29.2 Vc, 400 W, 13.7 A, AEC-Q101, SMA	SMA	SZ1SMA18AT3G	Littelfuse
R27	0	11.5k	RES, 11.5 k, 1%, 0.1 W, AEC-Q200 Grade 0, 0603	0603	CRCW060311K5FKEA	Vishay-Dale

IMPORTANT NOTICE AND DISCLAIMER

TI PROVIDES TECHNICAL AND RELIABILITY DATA (INCLUDING DATA SHEETS), DESIGN RESOURCES (INCLUDING REFERENCE DESIGNS), APPLICATION OR OTHER DESIGN ADVICE, WEB TOOLS, SAFETY INFORMATION, AND OTHER RESOURCES "AS IS" AND WITH ALL FAULTS, AND DISCLAIMS ALL WARRANTIES, EXPRESS AND IMPLIED, INCLUDING WITHOUT LIMITATION ANY IMPLIED WARRANTIES OF MERCHANTABILITY, FITNESS FOR A PARTICULAR PURPOSE OR NON-INFRINGEMENT OF THIRD PARTY INTELLECTUAL PROPERTY RIGHTS.

These resources are intended for skilled developers designing with TI products. You are solely responsible for (1) selecting the appropriate TI products for your application, (2) designing, validating and testing your application, and (3) ensuring your application meets applicable standards, and any other safety, security, regulatory or other requirements.

These resources are subject to change without notice. TI grants you permission to use these resources only for development of an application that uses the TI products described in the resource. Other reproduction and display of these resources is prohibited. No license is granted to any other TI intellectual property right or to any third party intellectual property right. TI disclaims responsibility for, and you will fully indemnify TI and its representatives against, any claims, damages, costs, losses, and liabilities arising out of your use of these resources.

TI's products are provided subject to [TI's Terms of Sale](#) or other applicable terms available either on ti.com or provided in conjunction with such TI products. TI's provision of these resources does not expand or otherwise alter TI's applicable warranties or warranty disclaimers for TI products.

TI objects to and rejects any additional or different terms you may have proposed.

Mailing Address: Texas Instruments, Post Office Box 655303, Dallas, Texas 75265
Copyright © 2022, Texas Instruments Incorporated