

**ABSTRACT**

The TPS7H2211EVM-CVAL is the Evaluation Module (EVM) for the TPS7H2211-SP load switch and provides a platform to electrically evaluate its features. This user's guide provides details about the EVM, including its configuration, schematics, and BOM. Test results that were collected using the EVM are also shown.

Table of Contents

1 Introduction	2
1.1 Default Board Configuration.....	2
1.2 Alternate Board Configurations.....	3
2 EVM Connectors and Test Points	4
3 Test Results	5
3.1 Default Configuration Results.....	5
3.2 Parallel Configuration Results.....	7
4 Board Layout	9
5 Schematic	13
5.1 Default Configuration Schematic.....	13
5.2 Parallel Configuration Schematic.....	14
6 Bill of Materials (BOM)	15
6.1 Default Configuration BOM.....	15
6.2 Parallel Configuration BOM.....	17

List of Figures

Figure 1-1. Default Configuration Simplified Schematic.....	2
Figure 2-1. TPS7H2211EVM-CVAL 3D Rendering (Top).....	4
Figure 3-1. Default Configuration: Startup.....	5
Figure 3-2. Default Configuration: Shutdown.....	5
Figure 3-3. Default Configuration: Assertion of OVP Due to Input Voltage.....	6
Figure 3-4. Default Configuration: Deassertion of OVP Due to Input Voltage.....	6
Figure 3-5. Parallel Configuration: Startup.....	7
Figure 3-6. Parallel Configuration: Shutdown.....	7
Figure 3-7. Parallel Configuration: Assertion of OVP due to Input Voltage.....	8
Figure 3-8. Parallel Configuration: Deassertion of OVP due to Input Voltage.....	8
Figure 4-1. Top Silkscreen.....	9
Figure 4-2. Top Solder.....	9
Figure 4-3. Top Layer.....	10
Figure 4-4. Signal Layer 1.....	10
Figure 4-5. Signal Layer 2.....	11
Figure 4-6. Bottom Layer.....	11
Figure 4-7. Bottom Solder.....	12
Figure 5-1. TPS7H2211EVM-CVAL Default Schematic.....	13
Figure 5-2. TPS7H2211EVM-CVAL Parallel Schematic.....	14

List of Tables

Table 1-1. TPS7H2211EVM-CVAL Default Configuration.....	2
Table 1-2. TPS7H2211EVM-CVAL Parallel Configuration.....	3
Table 2-1. Summary of Connectors and Test Points.....	4
Table 6-1. TPS7H2211EVM-CVAL Default BOM.....	15
Table 6-2. TPS7H2201EVM-CVAL Parallel BOM.....	17

Trademarks

All trademarks are the property of their respective owners.

1 Introduction

The TPS7H2211-SP is a single-channel load switch that provides reverse current protection, overvoltage protection, and a configurable rise time to minimize inrush current (soft start). The device contains P-channel MOSFETs that operate over an input voltage range of 4.5 V to 14 V and supports a maximum continuous current of 3.5 A. The switch is controlled by an on and off input (EN), that is capable of interfacing directly with low-voltage control signals. Overvoltage protection and soft start are programmable with few external components through the OVP and SS pins.

1.1 Default Board Configuration

The EVM is designed to be used across the entire input voltage and output current range of the TPS7H2211-SP while providing flexibility to configure the device to operate under different conditions. By default, the EVM is configured for a single device as summarized in [Table 1-1](#), but the board provides footprints that can be populated with an additional device and passive components to allow for testing of parallel or cold sparing applications.

More detailed information about the default EVM configuration can be found in the [Default Configuration Schematic](#) and the [Default Configuration Bill of Materials](#).

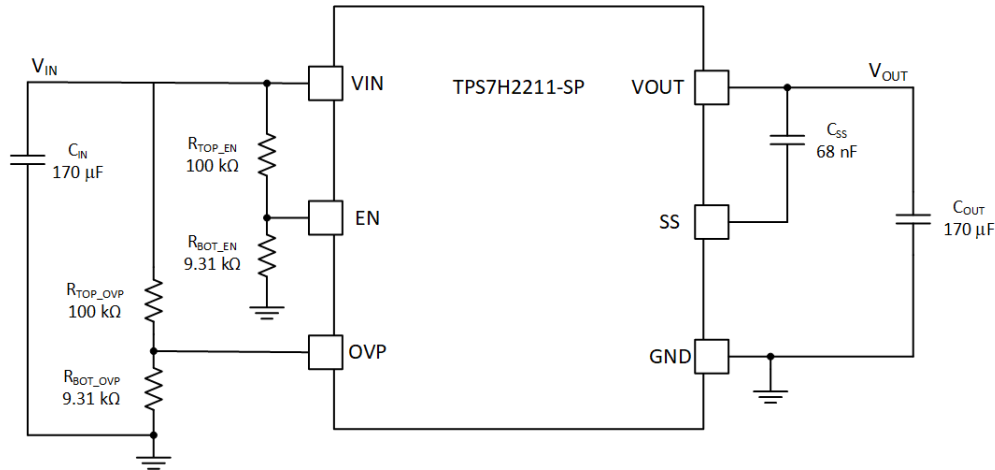

Figure 1-1. Default Configuration Simplified Schematic

Table 1-1. TPS7H2211EVM-CVAL Default Configuration

Specification	Value	Description
Input Voltage V_{IN}	12 V	Falls within the recommended device input voltage range of 4.5 V to 14 V.
Output Current I_{OUT}	0 to 3.5 A	Does not exceed maximum device continuous switch current of 3.5 A per device.
EN Turn-on Voltage $V_{IN_{EN_RISE}}$	7.4 V	Typical EN turn-on and turn-off values. Set by:
EN Turn-off Voltage $V_{IN_{EN_FALL}}$	6.1 V	R1 (R_{TOP_EN}) = 100 kΩ R4 (R_{BOT_EN}) = 9.31 kΩ
OVP Enter Voltage $V_{IN_{OVP_RISE}}$	13.5 V	Typical OVP enter and exit values. Set by:
OVP Exit Voltage $V_{IN_{OVP_FALL}}$	13.4 V	R3 (R_{TOP_OVP}) = 100 kΩ R5 (R_{BOT_OVP}) = 9.31 kΩ
Soft Start Time t_{SS}	~10 ms	Typical time to go from 10% to 90% of the final voltage. Set by: C1 (C_{SS}) = 68 nF

1.2 Alternate Board Configurations

If a custom configuration is desired, users should refer to the [TPS7H2211-SP data sheet](#) to calculate the values of the passive components around the device and note any operational requirements.

In addition to the default EVM configuration, this user's guide provides an example for how the TPS7H2211EVM-CVAL may be configured for parallel operation. The enable (EN) and overvoltage protection (OVP) specifications for the parallel configuration are the same as what is used for the default configuration. However, this configuration is capable of providing up to double the output current compared to the default configuration.

More detailed information about the parallel EVM configuration can be found in the [Parallel Configuration Schematic](#) and the [Parallel Configuration Bill of Materials](#).

Table 1-2. TPS7H2211EVM-CVAL Parallel Configuration

Specification	Value	Description
Input Voltage V_{IN}	13 V	Falls within the recommended device input voltage range of 4.5 to 14 V.
Output Current I_{OUT}	0 to 7 A	Does not exceed maximum device continuous switch current of 3.5 A per device.
EN Turn-on Voltage $V_{IN_EN_RISE}$	7.4 V	Typical EN turn-on and turn-off values. Set by:
EN Turn-off Voltage $V_{IN_EN_FALL}$	6.1 V	R1 (R_{TOP_EN}) = 100 k Ω R4 (R_{BOT_EN}) = 9.31 k Ω R15 populated
OVP Enter Voltage $V_{IN_OVP_RISE}$	13.5 V	Typical OVP enter and exit values. Set by:
OVP Exit Voltage $V_{IN_OVP_FALL}$	13.4 V	R3 (R_{TOP_OVP}) = 100 k Ω R5 (R_{BOT_OVP}) = 9.31 k Ω R17 populated
Soft Start Time t_{SS}	~10.9 ms	Typical time to go from 10% to 90% of the final voltage. Set by: C1 (C_{SS}) = 68 nF C16 (C_{SS}) = 68 nF R16 populated

2 EVM Connectors and Test Points

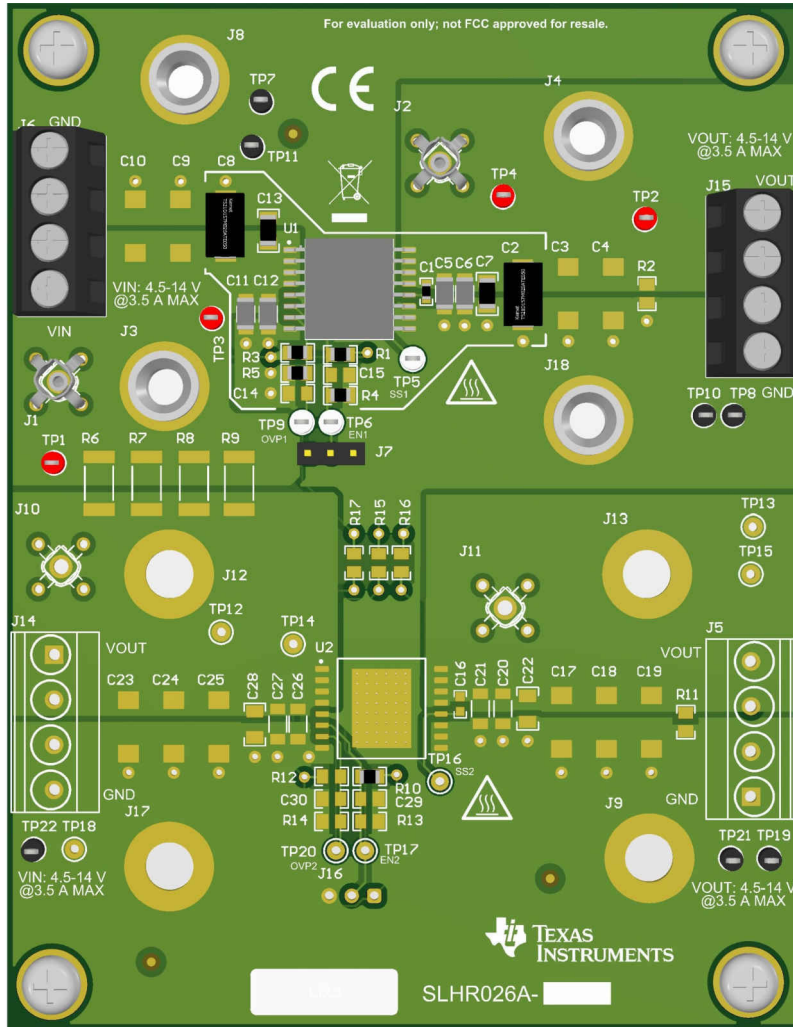

Figure 2-1. TPS7H2211EVM-CVAL 3D Rendering (Top)

Table 2-1. Summary of Connectors and Test Points

Reference Designator	Function	
J3, J6 (pins 3 & 4)	VIN	Input Voltage and Current for Board
J8, J6 (pins 1 & 2)	GND	
J4, J15 (pins 3 & 4)	VOUT	
J18, J15 (pins 1 & 2)	GND	Output Voltage and Current for Board
J1, TP1, TP3	Input Voltage Test Points	
J2, TP2, TP4	Output Voltage Test Points	
TP7, TP8, TP10, TP11	Ground Test Points	
TP5	Soft Start Test Point	
TP6	Enable Test Point	
TP9	OVP Test Point	

3 Test Results

Test results are shown for both the default configuration and the parallel configuration shown in this document. For each configuration, the following tests were performed:

1. Startup
2. Shutdown
3. OVP Assertion
4. OVP Deassertion

3.1 Default Configuration Results

The results shown in [Figure 3-1](#) through [Figure 3-4](#) were observed using the TPS7H2211EVM-CVAL in its default configuration with $V_{IN} = 12\text{ V}$.

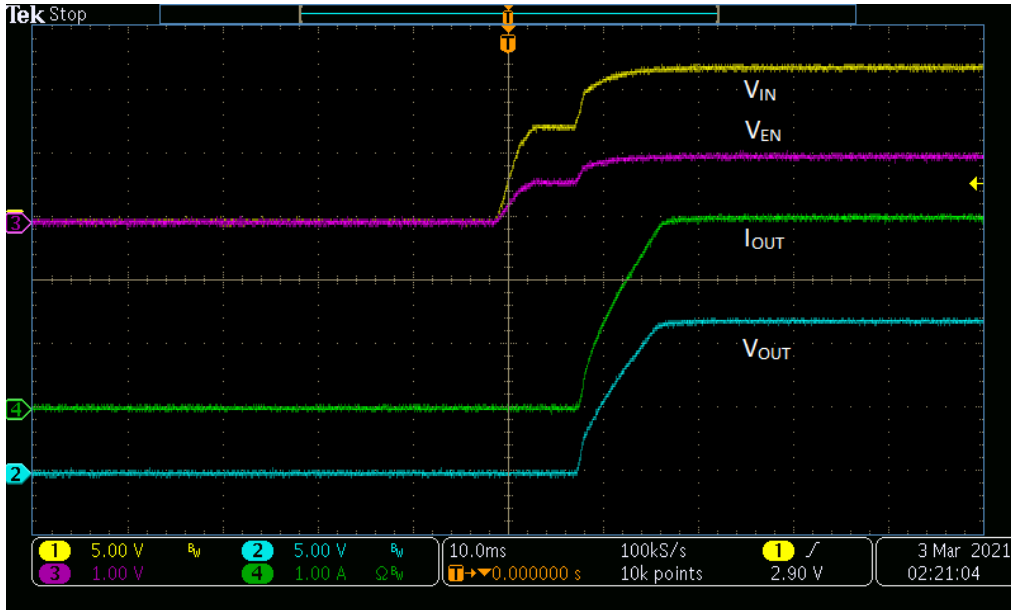

Figure 3-1. Default Configuration: Startup

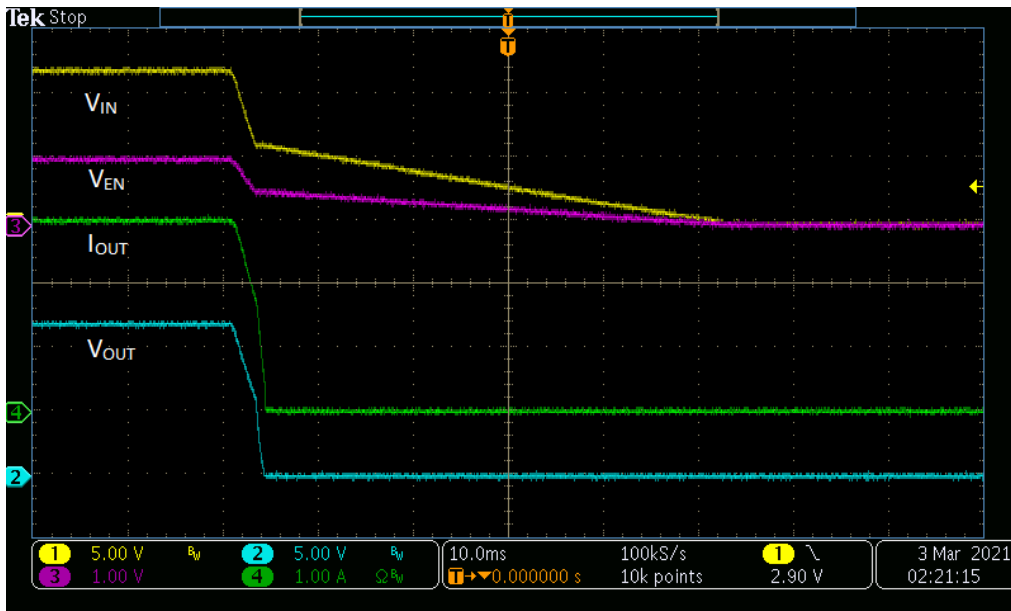

Figure 3-2. Default Configuration: Shutdown

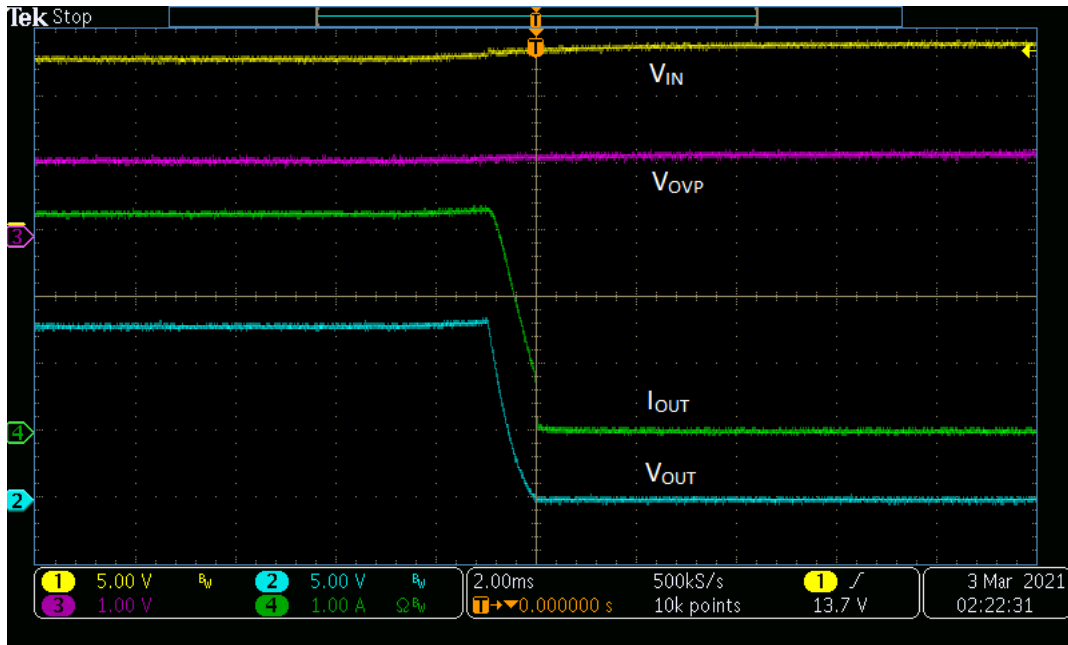

Figure 3-3. Default Configuration: Assertion of OVP Due to Input Voltage



Figure 3-4. Default Configuration: Deassertion of OVP Due to Input Voltage

3.2 Parallel Configuration Results

The results shown in Figure 3-5 through Figure 3-8 were observed using the TPS7H2211EVM-CVAL in the parallel configuration shown in this document with $V_{IN} = 13\text{ V}$.

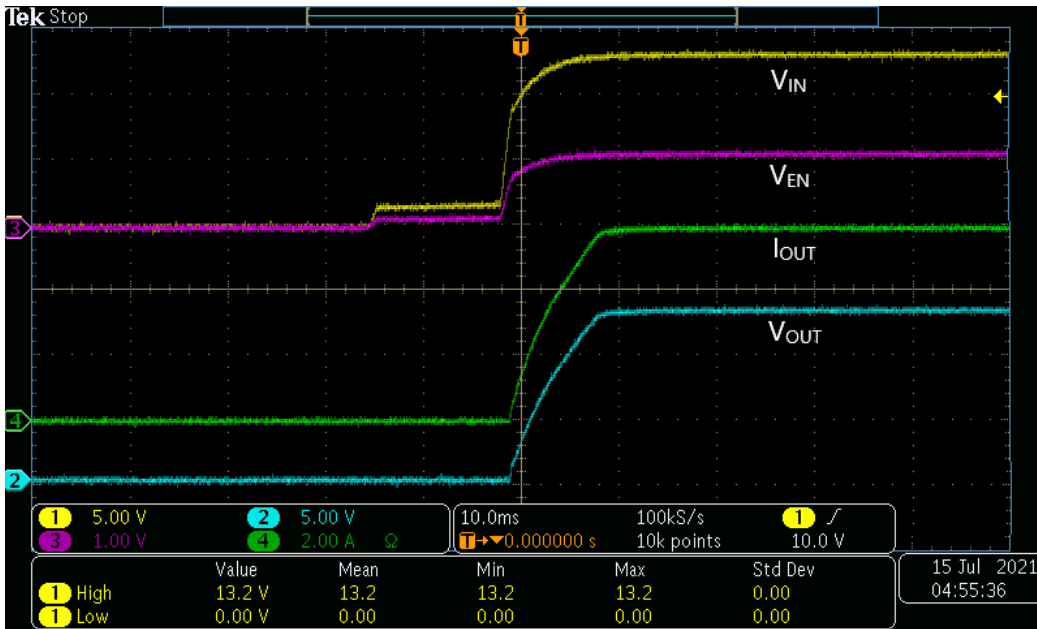

Figure 3-5. Parallel Configuration: Startup

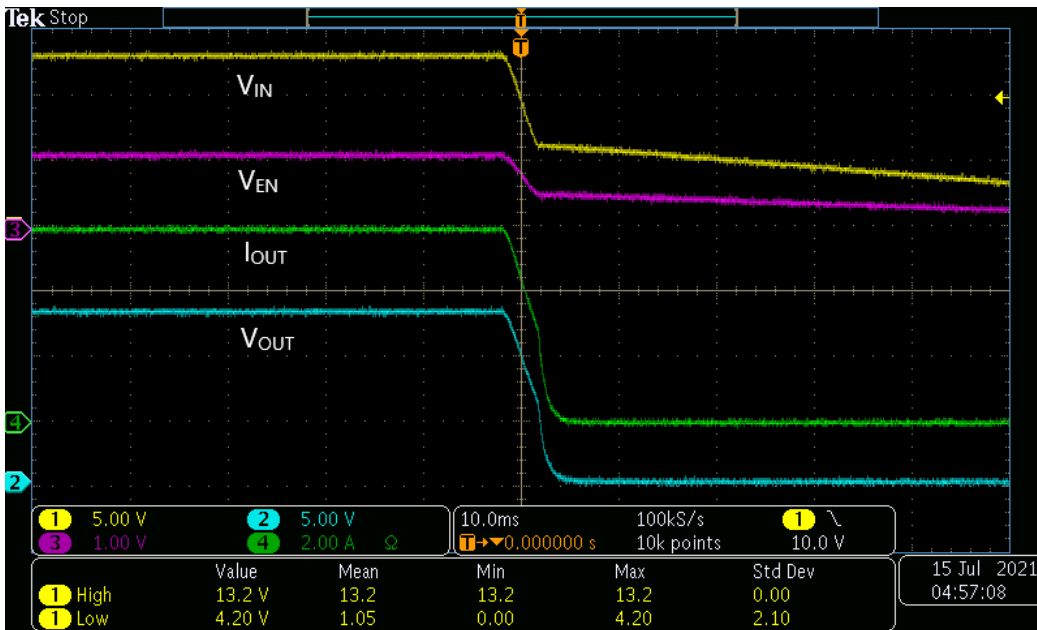

Figure 3-6. Parallel Configuration: Shutdown

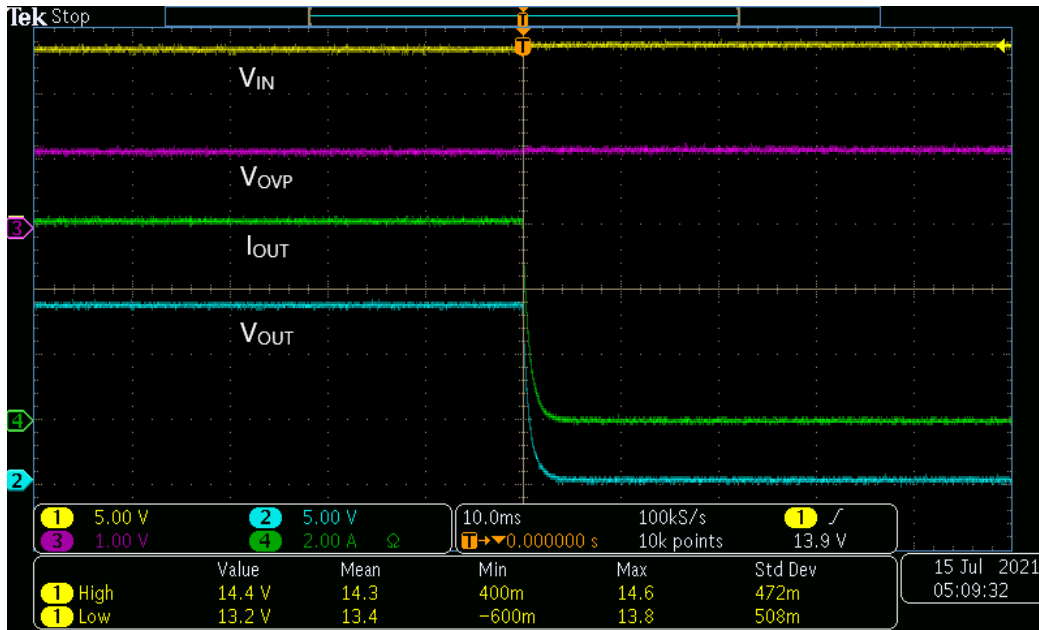

Figure 3-7. Parallel Configuration: Assertion of OVP due to Input Voltage

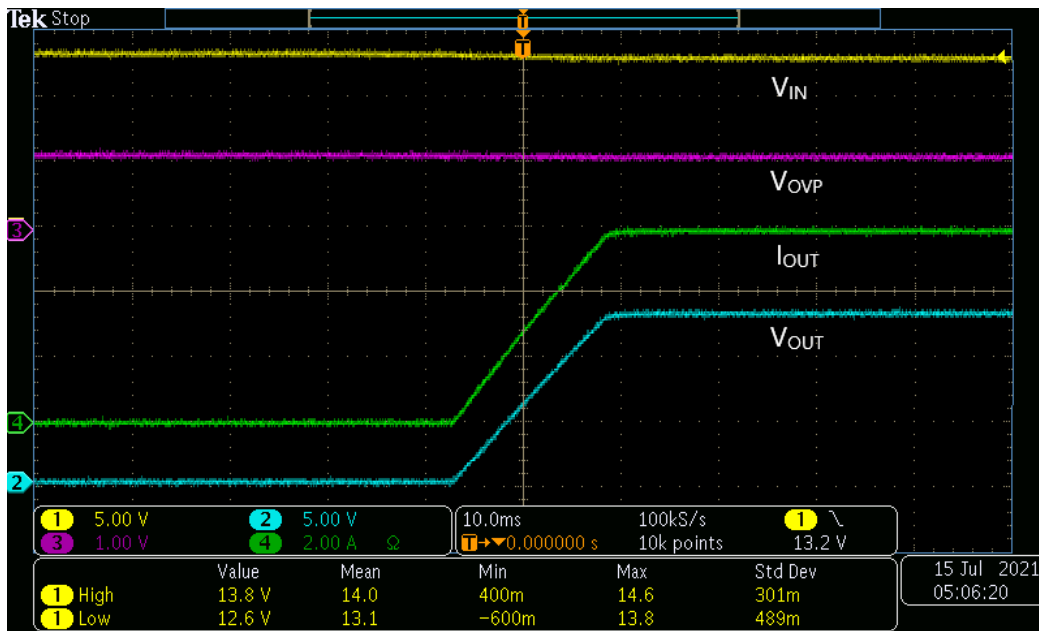

Figure 3-8. Parallel Configuration: Deassertion of OVP due to Input Voltage

4 Board Layout

Figure 4-1 through Figure 4-7 show the layout of the TPS7H2211EVM-CVAL.

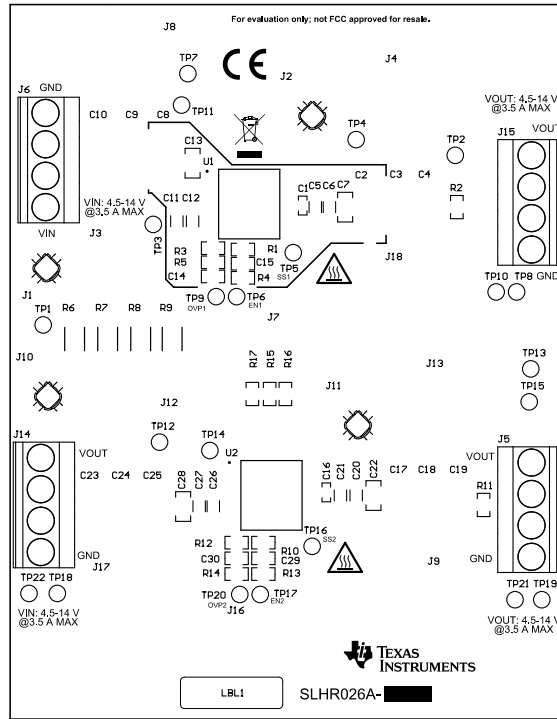

Figure 4-1. Top Silkscreen

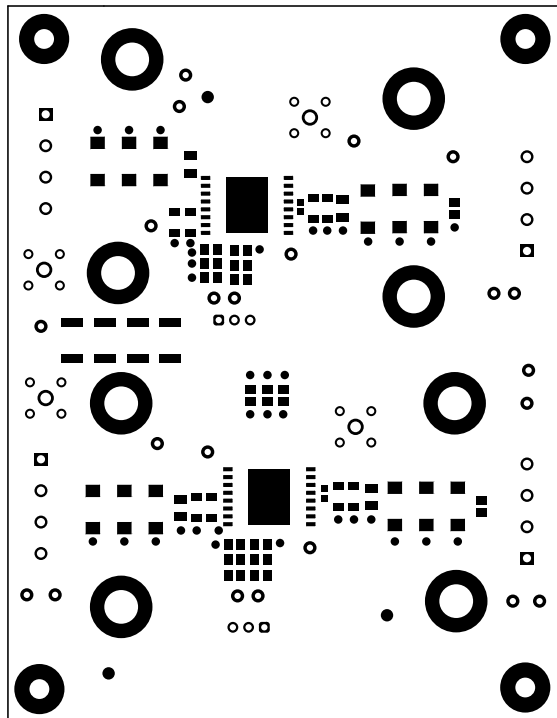

Figure 4-2. Top Solder

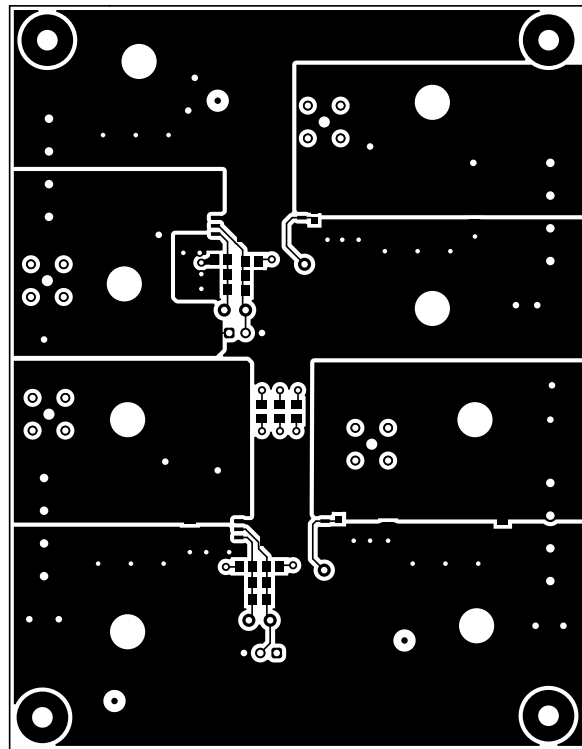

Figure 4-3. Top Layer

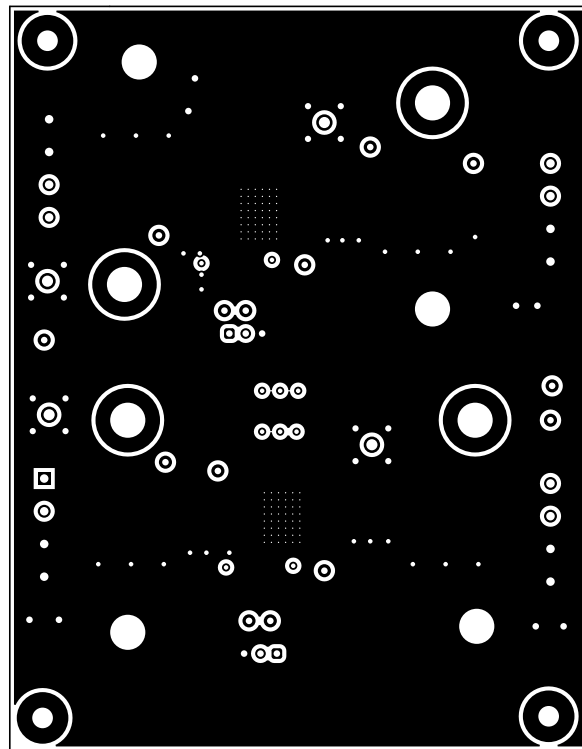

Figure 4-4. Signal Layer 1

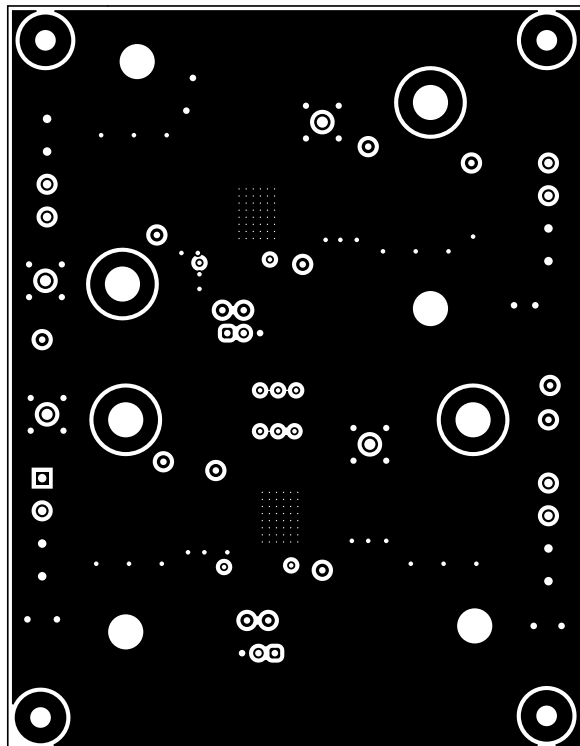

Figure 4-5. Signal Layer 2

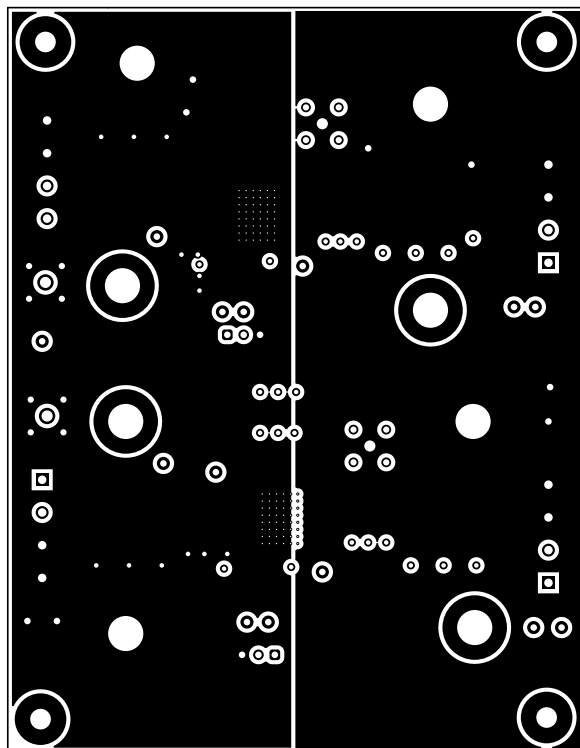

Figure 4-6. Bottom Layer

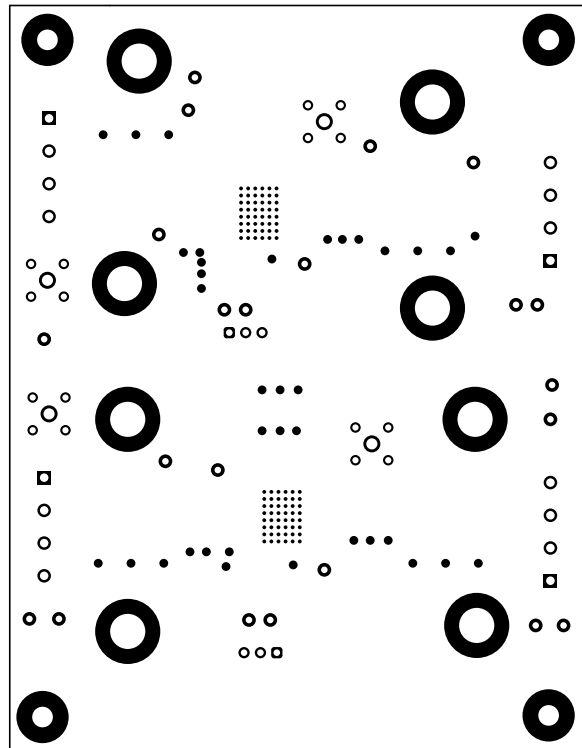

Figure 4-7. Bottom Solder

5 Schematic

Figure 5-1 shows the default TPS7H2211EVM-CVAL schematic. Figure 5-2 is the schematic for the parallel configuration of the EVM shown in this document.

5.1 Default Configuration Schematic

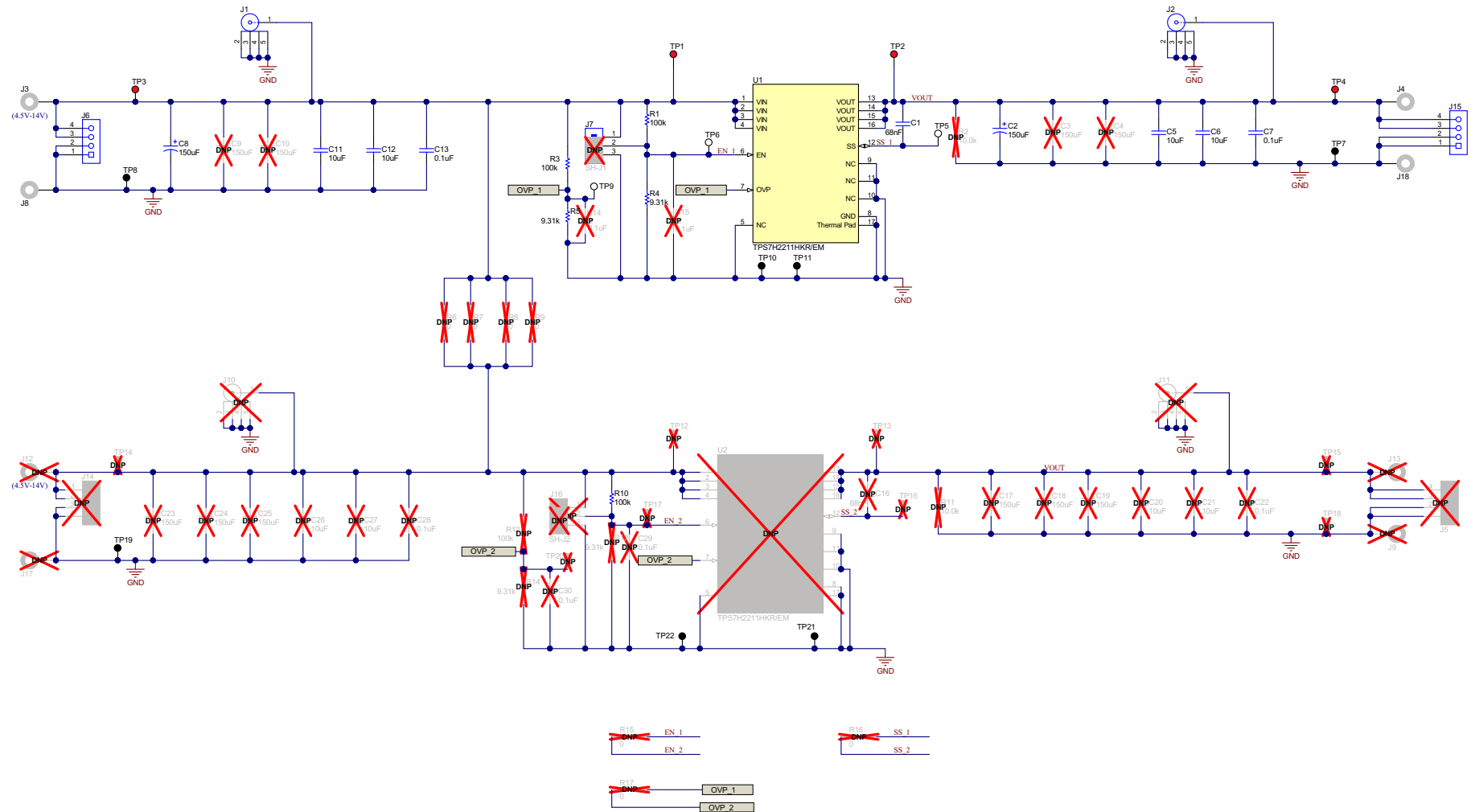

Figure 5-1. TPS7H2211EVM-CVAL Default Schematic

5.2 Parallel Configuration Schematic

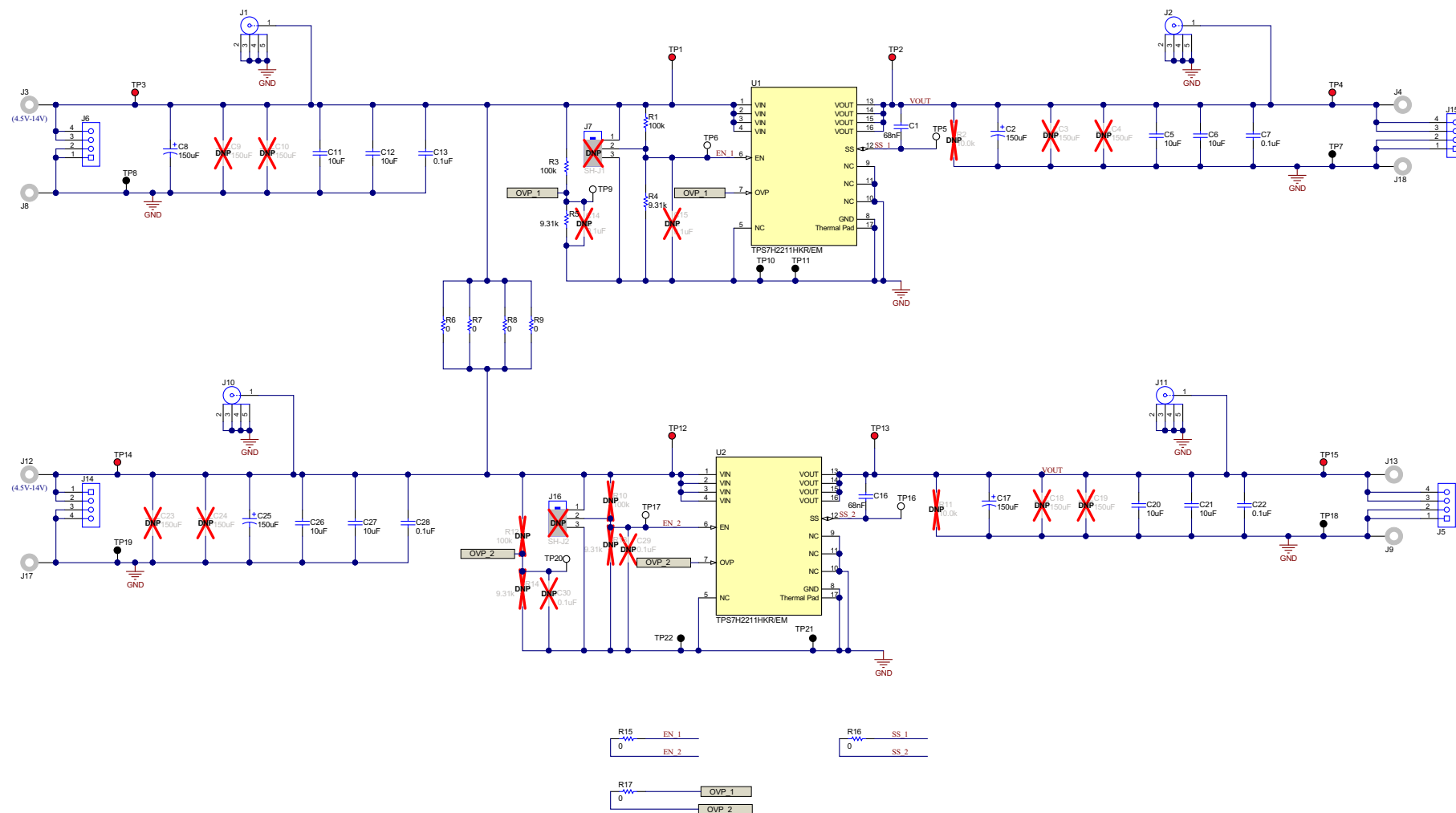

Figure 5-2. TPS7H2211EVM-CVAL Parallel Schematic

6 Bill of Materials (BOM)

Table 6-1 lists the BOM for the default EVM configuration. Table 6-2 lists the BOM for the parallel configuration of the EVM shown in this document.

6.1 Default Configuration BOM

Table 6-1. TPS7H2211EVM-CVAL Default BOM

Designator	Quantity	Description	Part Number	Manufacturer
!PCB1	1	Printed Circuit Board	SLHR026	Any
C1	1	CAP, CERM, 0.068 uF, 50 V, +/- 10%, X7R, 0603	C1608X7R1H683K080AA	TDK
C2, C8	2	150µF Molded Tantalum Polymer Capacitor 20V 2917 (7343 Metric) 50mOhm @ 100kHz	T521D157M020ATE050	Kemet
C5, C6, C11, C12	4	CAP, CERM, 10 uF, 50 V, +/- 10%, X5R, 1206	GRM31CR61H106KA12L	MuRata
C7, C13	2	CAP, CERM, 0.1 uF, 50 V, +/- 5%, X7R, 1206	12065C104JAT2A	AVX
H1, H2, H3, H4	4	Machine Screw, Round, #4-40 x 1/4, Nylon, Philips panhead	NY PMS 440 0025 PH	B&F Fastener Supply
H5, H6, H7, H8	4	Standoff, Hex, 0.5"L #4-40 Nylon	1902C	Keystone
J1, J2	2	Compact Probe Tip Circuit Board Test Points, TH, 25 per	131-5031-00	Tektronix
J3, J4, J8, J18	4	Standard Banana Jack, Uninsulated, 5.5mm	575-4	Keystone
J6, J15	2	Terminal Block, 4x1, 5.08mm, TH	39544-3004	Molex
J7	1	Header, 100mil, 3x1, Gold, TH	TSW-103-07-G-S	Samtec
LBL1	1	Thermal Transfer Printable Labels, 0.650" W x 0.200" H - 10,000 per roll	THT-14-423-10	Brady
R1, R3	2	RES, 100 k, 1%, 0.125 W, 0805	CRG0805F100K	TE Connectivity
R4, R5	2	RES, 9.31 k, 1%, 0.125 W, AEC-Q200 Grade 0, 0805	CRCW08059K31FKEA	Vishay-Dale
TP1, TP2, TP3, TP4	4	Test Point, Miniature, Red, TH	5000	Keystone
TP5, TP6, TP9	3	Test Point, Miniature, White, TH	5002	Keystone
TP7, TP8, TP10, TP11, TP19, TP21, TP22	7	Test Point, Miniature, Black, TH	5001	Keystone
U1	1	Radiation Hardened 7-V, 6-A Load Switch, HKR0016A (CFP-16)	TPS7H2211HKR/EM	Texas Instruments
C3, C4, C9, C10, C17, C18, C19, C23, C24, C25	0	150µF Molded Tantalum Polymer Capacitor 20V 2917 (7343 Metric) 50mOhm @ 100kHz	T521D157M020ATE050	Kemet
C14, C15, C29, C30	0	CAP, CERM, 0.1 uF, 25 V, +/- 5%, X7R, 0805	08053C104JAZ2A	AVX
C16	0	CAP, CERM, 0.068 uF, 50 V, +/- 10%, X7R, 0603	C1608X7R1H683K080AA	TDK
C20, C21, C26, C27	0	CAP, CERM, 10 uF, 50 V, +/- 10%, X5R, 1206	GRM31CR61H106KA12L	MuRata
C22, C28	0	CAP, CERM, 0.1 uF, 50 V, +/- 5%, X7R, 1206	12065C104JAT2A	AVX
FID1, FID2, FID3	0	Fiducial mark. There is nothing to buy or mount.	N/A	N/A

Table 6-1. TPS7H2211EVM-CVAL Default BOM (continued)

Designator	Quantity	Description	Part Number	Manufacturer
J5, J14	0	Terminal Block, 4x1, 5.08mm, TH	39544-3004	Molex
J9, J12, J13, J17	0	Standard Banana Jack, Uninsulated, 5.5mm	575-4	Keystone
J10, J11	0	Compact Probe Tip Circuit Board Test Points, TH, 25 per	131-5031-00	Tektronix
J16	0	Header, 100mil, 3x1, Gold, TH	TSW-103-07-G-S	Samtec
R2, R11	0	RES, 10.0 k, 1%, 0.2 W, 0805	MCU08050C1002FP500	Vishay/Beyschlag
R6, R7, R8, R9	0	RES, 0, 5%, 1 W, 2512	RC6432J000CS	Samsung
R10, R12	0	RES, 100 k, 1%, 0.125 W, 0805	CRG0805F100K	TE Connectivity
R13, R14	0	RES, 9.31 k, 1%, 0.125 W, AEC-Q200 Grade 0, 0805	CRCW08059K31FKEA	Vishay-Dale
R15, R16, R17	0	RES, 0, 5%, 0.125 W, AEC-Q200 Grade 0, 0805	CRCW08050000Z0EA	Vishay-Dale
SH-J1, SH-J2	0	Shunt, 100mil, Flash Gold, Black	SPC02SYAN	Sullins Connector Solutions
TP12, TP13, TP14, TP15	0	Test Point, Miniature, Red, TH	5000	Keystone
TP16, TP17, TP20	0	Test Point, Miniature, White, TH	5002	Keystone
TP18	0	Test Point, Miniature, Black, TH	5001	Keystone
U2	0	Radiation Hardened 7-V, 6-A Load Switch, HKR0016A (CFP-16)	TPS7H2211HKR/EM	Texas Instruments

6.2 Parallel Configuration BOM

Table 6-2. TPS7H2201EVM-CVAL Parallel BOM

Designator	Quantity	Description	Part Number	Manufacturer
!PCB1	1	Printed Circuit Board	SLHR026	Any
C1	1	CAP, CERM, 0.068 uF, 50 V, +/- 10%, X7R, 0603	C1608X7R1H683K080AA	TDK
C2, C8, C17, C25	4	150µF Molded Tantalum Polymer Capacitor 20V 2917 (7343 Metric) 50mOhm @ 100kHz	T521D157M020ATE050	Kemet
C5, C6, C11, C12, C20, C21, C26, C27	8	CAP, CERM, 10 uF, 50 V, +/- 10%, X5R, 1206	GRM31CR61H106KA12L	MuRata
C7, C13, C22, C28	4	CAP, CERM, 0.1 uF, 50 V, +/- 5%, X7R, 1206	12065C104JAT2A	AVX
H1, H2, H3, H4	4	Machine Screw, Round, #4-40 x 1/4, Nylon, Philips panhead	NY PMS 440 0025 PH	B&F Fastener Supply
H5, H6, H7, H8	4	Standoff, Hex, 0.5"L #4-40 Nylon	1902C	Keystone
J1, J2, J10, J11	4	Compact Probe Tip Circuit Board Test Points, TH, 25 per	131-5031-00	Tektronix
J3, J4, J8, J9, J12, J13, J17, J18	8	Standard Banana Jack, Uninsulated, 5.5mm	575-4	Keystone
J5, J6, J14, J15	4	Terminal Block, 4x1, 5.08mm, TH	39544-3004	Molex
J7, J16	2	Header, 100mil, 3x1, Gold, TH	TSW-103-07-G-S	Samtec
LBL1	1	Thermal Transfer Printable Labels, 0.650" W x 0.200" H - 10,000 per roll	THT-14-423-10	Brady
R1, R3, R10, R12	4	RES, 100 k, 1%, 0.125 W, 0805	CRG0805F100K	TE Connectivity
R4, R5, R13, R14	4	RES, 9.31 k, 1%, 0.125 W, AEC-Q200 Grade 0, 0805	CRCW08059K31FKEA	Vishay-Dale
R6, R7, R8, R9	4	RES, 0, 5%, 1 W, 2512	RC6432J000CS	Samsung
R15, R16, R17	3	RES, 0, 5%, 0.125 W, AEC-Q200 Grade 0, 0805	CRCW08050000Z0EA	Vishay-Dale
TP1, TP2, TP3, TP4, TP12, TP13, TP14, TP15	8	Test Point, Miniature, Red, TH	5000	Keystone
TP5, TP6, TP9, TP16, TP17, TP20	6	Test Point, Miniature, White, TH	5002	Keystone
TP7, TP8, TP10, TP11, TP18, TP19, TP21, TP22	8	Test Point, Miniature, Black, TH	5001	Keystone
U1, U2	2	Radiation Hardened 7-V, 6-A Load Switch, HKR0016A (CFP-16)	TPS7H2211HKR/EM	Texas Instruments
C3, C4, C9, C10, C18, C19, C23, C24	0	150µF Molded Tantalum Polymer Capacitor 20V 2917 (7343 Metric) 50mOhm @ 100kHz	T521D157M020ATE050	Kemet
C14, C15, C29, C30	0	CAP, CERM, 0.1 uF, 25 V, +/- 5%, X7R, 0805	08053C104JAZ2A	AVX
C16	0	CAP, CERM, 0.068 uF, 50 V, +/- 10%, X7R, 0603	C1608X7R1H683K080AA	TDK
FID1, FID2, FID3	0	Fiducial mark. There is nothing to buy or mount.	N/A	N/A

Table 6-2. TPS7H2201EVM-CVAL Parallel BOM (continued)

Designator	Quantity	Description	Part Number	Manufacturer
R2, R11	0	RES, 10.0 k, 1%, 0.2 W, 0805	MCU08050C1002FP500	Vishay/Beyschlag
SH-J1, SH-J2	0	Shunt, 100mil, Flash Gold, Black	SPC02SYAN	Sullins Connector Solutions

IMPORTANT NOTICE AND DISCLAIMER

TI PROVIDES TECHNICAL AND RELIABILITY DATA (INCLUDING DATA SHEETS), DESIGN RESOURCES (INCLUDING REFERENCE DESIGNS), APPLICATION OR OTHER DESIGN ADVICE, WEB TOOLS, SAFETY INFORMATION, AND OTHER RESOURCES "AS IS" AND WITH ALL FAULTS, AND DISCLAIMS ALL WARRANTIES, EXPRESS AND IMPLIED, INCLUDING WITHOUT LIMITATION ANY IMPLIED WARRANTIES OF MERCHANTABILITY, FITNESS FOR A PARTICULAR PURPOSE OR NON-INFRINGEMENT OF THIRD PARTY INTELLECTUAL PROPERTY RIGHTS.

These resources are intended for skilled developers designing with TI products. You are solely responsible for (1) selecting the appropriate TI products for your application, (2) designing, validating and testing your application, and (3) ensuring your application meets applicable standards, and any other safety, security, regulatory or other requirements.

These resources are subject to change without notice. TI grants you permission to use these resources only for development of an application that uses the TI products described in the resource. Other reproduction and display of these resources is prohibited. No license is granted to any other TI intellectual property right or to any third party intellectual property right. TI disclaims responsibility for, and you will fully indemnify TI and its representatives against, any claims, damages, costs, losses, and liabilities arising out of your use of these resources.

TI's products are provided subject to [TI's Terms of Sale](#) or other applicable terms available either on ti.com or provided in conjunction with such TI products. TI's provision of these resources does not expand or otherwise alter TI's applicable warranties or warranty disclaimers for TI products.

TI objects to and rejects any additional or different terms you may have proposed.

Mailing Address: Texas Instruments, Post Office Box 655303, Dallas, Texas 75265
Copyright © 2022, Texas Instruments Incorporated