

TPS62873 Buck Converter Evaluation Module User's Guide



ABSTRACT

This user's guide describes the characteristics, operation, and use of TI's evaluation module (EVM) for the TPS62873-Q1 devices. The TPS62873EVM-143 is designed to help the user easily evaluate and test the operation and functionality of the TPS62873-Q1 buck converters. It also can be used to evaluate the TPS62870-Q1, TPS62871-Q1, and TPS62872-Q1 devices. The EVM converts 2.7-V to 6.0-V input voltage to a regulated 0.75-V output voltage. The output current can go up to 15 A for the TPS62873EVM-143. This user's guide includes setup instructions for the hardware, a printed-circuit board (PCB) layout, a schematic diagram, and a bill of materials (BOM).

Table of Contents

1 Warning and Caution	2
2 Introduction	3
3 Setup	3
4 TPS62873EVM-143 Test Results	4
5 Board Layout	4
6 Schematic and Bill of Materials	7

List of Figures

Figure 5-1. Top Silk.....	5
Figure 5-2. Top Layer.....	5
Figure 5-3. Layer 2.....	5
Figure 5-4. Layer 3.....	5
Figure 5-5. Layer 4.....	5
Figure 5-6. Layer 5.....	5
Figure 5-7. Layer 6.....	6
Figure 5-8. Layer 7.....	6
Figure 5-9. Bottom Layer.....	6
Figure 6-1. TPS62873EVM-143 Schematic.....	7

List of Tables

Table 2-1. Performance Specification Summary.....	3
Table 6-1. TPS62873EVM-143 BOM.....	8

Trademarks

All trademarks are the property of their respective owners.

1 Warning and Caution



Caution

Caution Hot surface.
Contact may cause burns.
Do not touch!

2 Introduction

The TPS62873-Q1 device is a high-frequency, synchronous step-down converter optimized for a small solution size and high efficiency. The devices focus on high-efficiency, step-down conversion over a wide output current range. At medium to heavy loads, the converter operates in PWM mode and automatically enters *power save mode* operation at light load to maintain high efficiency over the entire load-current range. The device is available in a 2.55-mm × 3.55-mm, 16-pin VQFN package.

2.1 Performance Specification

Table 2-1 provides a summary of the TPS62873EVM-143 performance specifications.

Table 2-1. Performance Specification Summary

Specification		Test Conditions	MIN	TYP	MAX	Unit
Input voltage			2.7		6.0	V
Output voltage setpoint				0.75		V
Output current	TPS62873EVM-143		0		15.0	A

2.2 Modifications

The printed-circuit board (PCB) for this EVM is designed to accommodate the different output current versions of this integrated circuit (IC). On the EVM, additional output capacitors can be added, the default output voltage can be changed, and the switching frequency can be modified.

2.2.1 Input and Output Capacitors

Footprints for additional input capacitors and additional output capacitors are provided. These capacitors are not required for proper operation, but can be used to reduce the input and output voltage ripple and to improve the load transient response. For proper operation, the total output capacitance must remain within the recommended range described in the [TPS6287x-Q1 Low Input Voltage, Adjustable-Frequency Step-Down Converter](#) data sheet.

2.2.2 Output Voltage Setting

The output voltage of U1 is set to a default of 0.75 V. Other default voltages can be set using appropriate values for the resistors R5 and R6. During operation, the output voltage can be changed using the I²C interface. For more details, see the [TPS6287x-Q1 Low Input Voltage, Adjustable-Frequency Step-Down Converter](#) data sheet.

2.2.3 Control Loop Compensation

C1, C2, and R1 are used for compensating the control loop. If the output capacitors have been changed adjustments, of the component values in the compensation network can be necessary. For more details, see the [TPS6287x-Q1 Low Input Voltage, Adjustable-Frequency Step-Down Converter](#) data sheet.

2.2.4 Switching Frequency Setting

The switching frequency is set to a default of 2.25 MHz. By changing the values of R3 and R4, the default switching frequency can be changed. For more details, see the [TPS6287x-Q1 Low Input Voltage, Adjustable-Frequency Step-Down Converter](#) data sheet.

2.2.5 I²C Interface

Output voltage, output voltage ramp time, soft-start time, and various control features can be controlled through the I²C interface. IC status information is also available. For more details, see the [TPS6287x-Q1 Low Input Voltage, Adjustable-Frequency Step-Down Converter](#) data sheet.

3 Setup

This section describes how to correctly use the TPS62873EVM-143.

3.1 Connector Descriptions

- MH1 - VIN** Positive input voltage connection from the input supply for the EVM
- J1-1 – VINsense, J1-2 – GNDsense** Input voltage sense connections, measure the input voltage at this point.

MH2 – GND	Input return connection from the input supply for the EVM
MH3 – VOUT	Positive output voltage connection
J2-1 – VOUTsense, J2-2 - GNDsense	Output voltage sense connections, measure the output voltage at this point.
MH4 – GND	Output return connection
JP1 – EN	EN pin jumper. Place the supplied jumper across ON and EN to turn on the IC. Place the jumper across OFF and EN to turn off the IC.
JP2 – MODE/SYNC	MODE/SYNC pin jumper. Place the supplied jumper across VIN and MODE/SYNC to force the device in fixed frequency PWM operation at all load currents. Place the jumper across MODE/SYNC and GND to enable power save mode. Connect a clock signal to MODE/SYNC referenced to GND to synchronize the switching frequency to the clock signal.
J3 – PG	The PG output appears on pin 1 of this header with a convenient ground on pin 2.
J4 – SYNC_OUT	At the SYNC_OUT output, the switching frequency is provided at pin 1 with a convenient ground on pin 2.
J5 – I2C	I ² C connection configured for being used with the USB2ANY interface.

3.2 Hardware Setup

To operate the EVM, set jumpers JP1 and JP2 to the desired positions per [Section 3.1](#). Connect the input supply to MH1 and MH2, between VIN and GND, and connect the load to MH3 and MH4 between VOUT and GND.

To evaluate the I²C features a [USB2ANY](#) interface can be connected to J5. For this interface, a software GUI is available [here](#).

4 TPS62873EVM-143 Test Results

The TPS62873EVM-143 was used to take the typical characteristics data in the TPS6287x-Q1 data sheet. See the [TPS6287x-Q1 Low Input Voltage, Adjustable-Frequency Step-Down Converter](#) data sheet for the performance of this EVM.

5 Board Layout

This section provides the TPS62873EVM-143 board layout. The gerber files are available on the [TPS62873EVM-143](#) tool page.

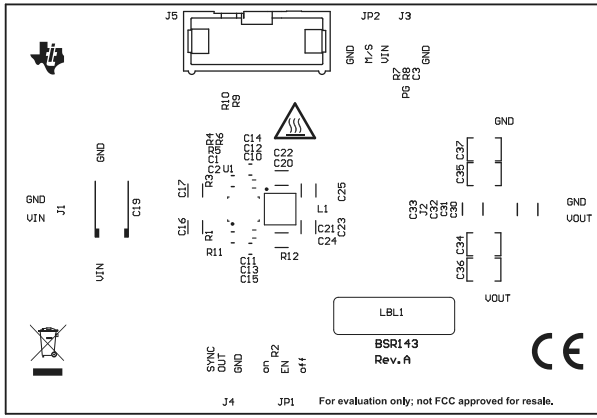

Figure 5-1. Top Silk

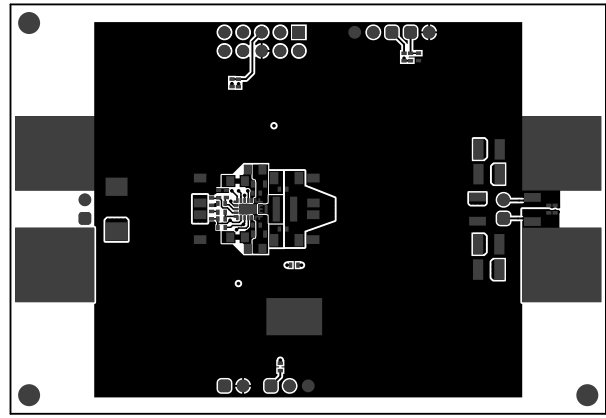

Figure 5-2. Top Layer

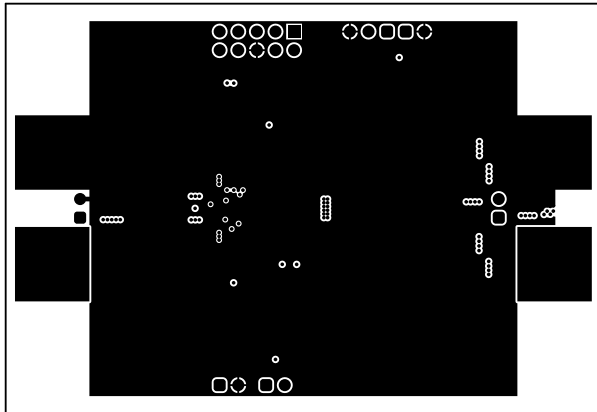

Figure 5-3. Layer 2

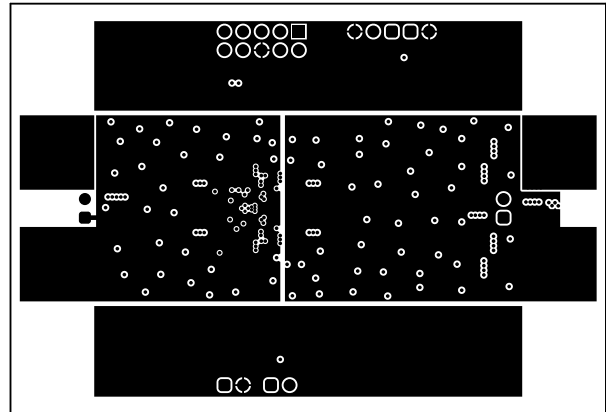

Figure 5-4. Layer 3

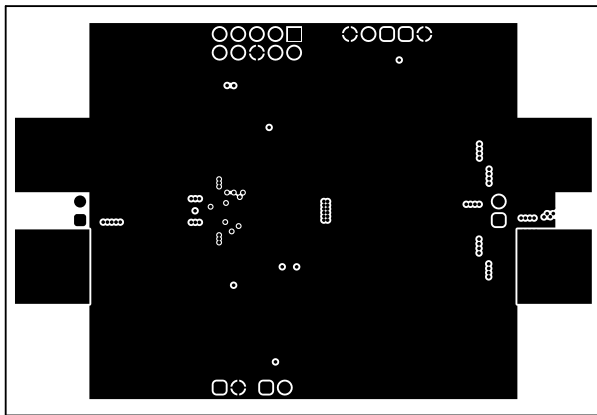

Figure 5-5. Layer 4

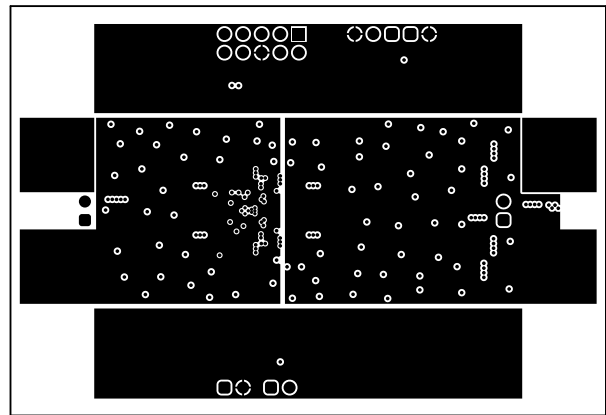

Figure 5-6. Layer 5

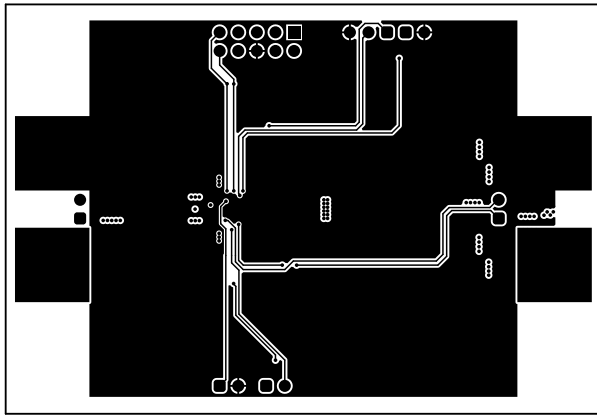

Figure 5-7. Layer 6

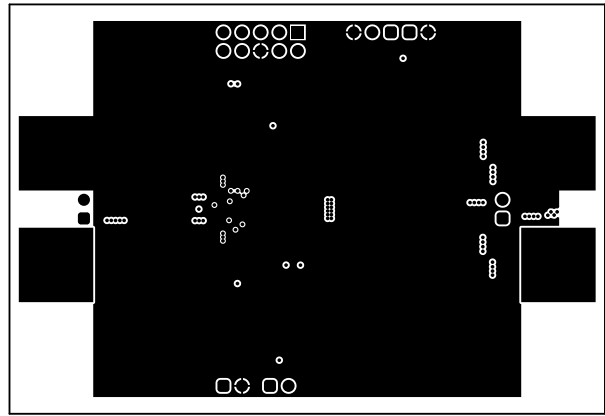

Figure 5-8. Layer 7

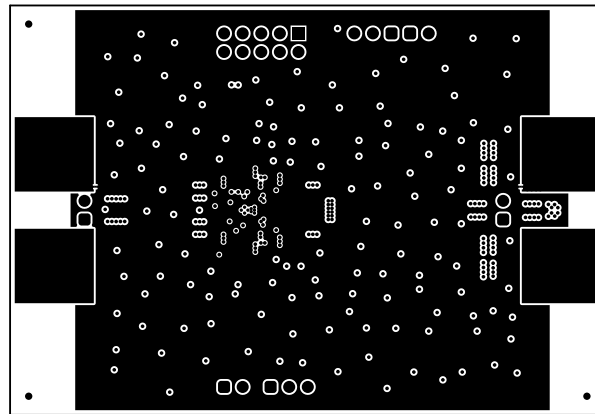

Figure 5-9. Bottom Layer

6 Schematic and Bill of Materials

This section includes the TPS62873EVM-143 schematics and bills of materials.

6.1 Schematic

Figure 6-1 shows the schematic of TPS62873EVM-143.

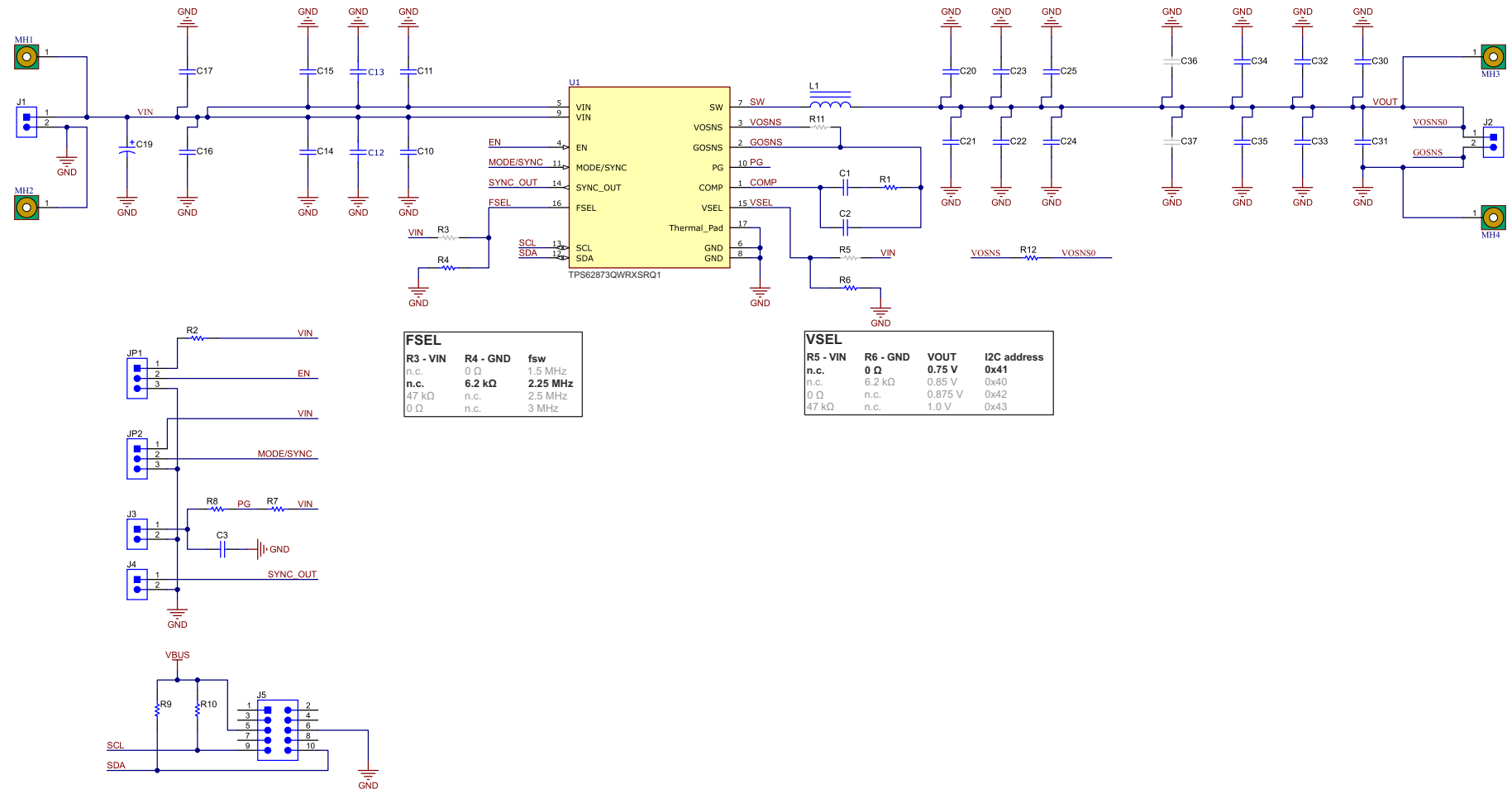

Figure 6-1. TPS62873EVM-143 Schematic

6.2 Bill of Materials

Table 6-1 lists the BOM for the TPS62873EVM-143.

Table 6-1. TPS62873EVM-143 BOM

Qty	Ref Des	Value	Description	Size	Part Number	MFR
6	C10, C11, C20, C21, C30, C31	0.47 μ F	Ceramic Capacitor, 10 V, X7S	0402	GCM155C71A474KE36D	any
2	C12, C13	2.2 μ F	Ceramic Capacitor, 10 V, X7S	0603	CGA3E3X7S1A225K080AB	TDK
2	C14, C15	10 μ F	Ceramic Capacitor, 10 V, X7R	0805	GCM21BR71A106KE22	MuRata
6	C16, C17, C22, C23, C24, C25	22 μ F	Ceramic Capacitor, 10 V, X7R	1206	GCM31CR71A226KE02	MuRata
2	C32, C33	47 μ F	Ceramic Capacitor, 6.3 V, X7R	1210	GCM32ER70J476ME19L	MuRata
2	C34, C35	100 μ F	Ceramic Capacitor, 6.3 V, X5R	1210	GRT32ER60J107ME13L	MuRata
1	C19	100 μ F	Polymer Capacitor, 10 V	7.3 \times 4.3 mm	10TQC100YF	Panasonic
1	C1	1800 pF	Ceramic Capacitor, 50 V, X7R	0402		any
1	C2, C3	10pF	Ceramic Capacitor, 50 V, COG/NPO	0402		any
1	L1	110 nH	Inductor	4.0 \times 4.0 \times 2.0 mm	XGL4020-111MEC	Coilcraft
1	R1	2.43 k Ω	Resistor 1%, 0.1 W	0402		any
2	R2	100 k Ω	Resistor 1%, 0.1 W	0402		any
1	R4	6.19 k Ω	Resistor 1%, 0.1 W	0402		any
2	R6, R12	0 Ω	Resistor 1%, 0.1 W	0402		any
1	R7	10 k Ω	Resistor 1%, 0.1 W	0402		any
2	R9, R10	2 k Ω	Resistor 1%, 0.1 W	0402		any
1	U1		2.7-V to 6-V Input, 15-A, Fast Transient Synchronous Step-Down Converter with I ² C Interface, Remote Sense, and Stackability	WQFN-FCRLF16	TPS62873QWRXSRQ1	Texas Instruments

IMPORTANT NOTICE AND DISCLAIMER

TI PROVIDES TECHNICAL AND RELIABILITY DATA (INCLUDING DATA SHEETS), DESIGN RESOURCES (INCLUDING REFERENCE DESIGNS), APPLICATION OR OTHER DESIGN ADVICE, WEB TOOLS, SAFETY INFORMATION, AND OTHER RESOURCES "AS IS" AND WITH ALL FAULTS, AND DISCLAIMS ALL WARRANTIES, EXPRESS AND IMPLIED, INCLUDING WITHOUT LIMITATION ANY IMPLIED WARRANTIES OF MERCHANTABILITY, FITNESS FOR A PARTICULAR PURPOSE OR NON-INFRINGEMENT OF THIRD PARTY INTELLECTUAL PROPERTY RIGHTS.

These resources are intended for skilled developers designing with TI products. You are solely responsible for (1) selecting the appropriate TI products for your application, (2) designing, validating and testing your application, and (3) ensuring your application meets applicable standards, and any other safety, security, regulatory or other requirements.

These resources are subject to change without notice. TI grants you permission to use these resources only for development of an application that uses the TI products described in the resource. Other reproduction and display of these resources is prohibited. No license is granted to any other TI intellectual property right or to any third party intellectual property right. TI disclaims responsibility for, and you will fully indemnify TI and its representatives against, any claims, damages, costs, losses, and liabilities arising out of your use of these resources.

TI's products are provided subject to [TI's Terms of Sale](#) or other applicable terms available either on ti.com or provided in conjunction with such TI products. TI's provision of these resources does not expand or otherwise alter TI's applicable warranties or warranty disclaimers for TI products.

TI objects to and rejects any additional or different terms you may have proposed.

Mailing Address: Texas Instruments, Post Office Box 655303, Dallas, Texas 75265
Copyright © 2022, Texas Instruments Incorporated