

TPS53819A Buck Controller Evaluation Module User's Guide



ABSTRACT

The TPS53819AEVM-123 evaluation module (EVM) is designed to evaluate the TPS53819A. The TPS53819A is a small-size single-buck controller with adaptive on-time D-CAP2 mode control. It provides a fixed 1.2-V output at up to 25 A from a nominal 12-V input bus. This controller is an analog PWM controller allowing programming and monitoring via the PMBus interface. The TPS53819AEVM-123 also uses a 5 mm × 6 mm TI power block MOSFET (CSD87350Q5D) for high power density and superior thermal performance.

Table of Contents

1 Description	2
1.1 Typical Applications	2
1.2 Features	2
2 Electrical Performance Specifications	3
3 Schematic	4
4 Test Setup	5
4.1 Test and Configuration Software	5
4.2 Test Equipment	5
4.3 Recommended Test Setup	6
4.4 List of Test Points	7
4.5 Jumper Configuration: Enable Selection	8
5 EVM Configuration Using the Fusion GUI	8
5.1 Configuration Procedure	8
5.2 Default Fusion GUI Screenshots and Description	8
6 Test Procedure	12
6.1 Line and Load Regulation and Efficiency Measurement Procedure	12
6.2 Control Loop Gain and Phase Measurement Procedure	12
6.3 Equipment Shutdown	12
7 Performance Data and Typical Characteristic Curves	13
7.1 Efficiency	13
7.2 Load Regulation	13
7.3 Line Regulation	14
7.4 f_{SW} Versus Load	14
7.5 Bode Plot	15
7.6 Transient Response	15
7.7 Output Ripple	16
7.8 Switching Node	17
7.9 Turn-On Waveform	18
7.10 Turn-Off Waveform	19
7.11 Pre-bias Turn-On Waveform	20
7.12 Thermal Images	20
8 EVM Assembly Drawing and PCB layout	22
9 Bill of Materials	26
10 Revision History	26

List of Figures

Figure 3-1. TPS53819AEVM-123 Schematic.....	4
Figure 4-1. Tip and Barrel Measurement for V_{OUT} Ripple.....	5
Figure 4-2. Probe with Short Ground Lead for V_{OUT} Ripple Across C14.....	6
Figure 4-3. TPS53819AEVM-123 Recommended Test Setup.....	7
Figure 5-1. Selection of Device Scan Options.....	8
Figure 5-2. TPS53819A GUI Configure General Tab.....	9
Figure 5-3. TPS53819A GUI Configure, All Config Tab.....	10
Figure 5-4. TPS53819A GUI Status.....	11
Figure 7-1. TPS53819AEVM-123 Efficiency.....	13
Figure 7-2. TPS53819AEVM-123 Load Regulation.....	13
Figure 7-3. TPS53819AEVM-123 Line Regulation.....	14
Figure 7-4. TPS53819AEVM-123 f_{SW} Versus Load.....	14
Figure 7-5. TPS53819AEVM-123 Loop Response Gain and Phase.....	15
Figure 7-6. TPS53819AEVM-123 Load Transient, 12 V_{IN} , 0-A to 15-A Eco-mode.....	15
Figure 7-7. TPS53819AEVM-123 Load Transient, 12 V_{IN} , 0-A to 15-A FCCM.....	16
Figure 7-8. TPS53819AEVM-123 Output Ripple, 12 V_{IN} , 25 A.....	16
Figure 7-9. TPS53819AEVM-123 Output Ripple, 12 V_{IN} , 1-A Load Eco-mode.....	17
Figure 7-10. TPS53819AEVM-123 Switching Node, 12- V_{IN} , 25-A Load Full Bandwidth.....	17
Figure 7-11. TPS53819AEVM-123 Enable Turn-On Waveform, 12- V_{IN} , 1- Ω Load.....	18
Figure 7-12. TPS53819AEVM-123 V_{IN} Turn-On Waveform, 12- V_{IN} , 1- Ω Load.....	18
Figure 7-13. TPS53819AEVM-123 Enable Turn-Off Waveform, 12 V_{IN} , 1- Ω Load.....	19
Figure 7-14. TPS53819AEVM-123 V_{IN} Turn off Waveform, 12 V_{IN} , 1- Ω Load.....	19
Figure 7-15. TPS53819AEVM-123 Enable Turn-On Waveform, 12 V_{IN} , 1- Ω Load, 1-V Pre-bias.....	20
Figure 7-16. TPS53819AEVM-123 Top Board, 12 V_{IN} , 25-A Fan.....	20
Figure 7-17. TPS53819AEVM-123 Bottom Board, 12 V_{IN} , 25-A Fan.....	21
Figure 8-1. TPS53819AEVM-123 Top Layer Assembly Drawing (Top View).....	22
Figure 8-2. TPS53819AEVM-123 Bottom Layer Assembly Drawing (Bottom View).....	22
Figure 8-3. TPS53819AEVM-123 Top Copper (Top View).....	23
Figure 8-4. TPS53819AEVM-123 Internal Layer 1 (Top View).....	23
Figure 8-5. TPS53819AEVM-123 Internal Layer 3 (Top View).....	24
Figure 8-6. TPS53819AEVM-123 Internal Layer 4 (Top View).....	24
Figure 8-7. TPS53819AEVM-123 Internal Layer 5 (Top View).....	25
Figure 8-8. TPS53819AEVM-123 Bottom Copper (Top View).....	25

List of Tables

Table 2-1. TPS53819AEVM-123 Electrical Performance Specifications ⁽¹⁾	3
Table 4-1. The Functions of Each Test Points.....	7
Table 4-2. Enable Selection.....	8
Table 9-1. TPS53819AEVM-123 List of Materials.....	26

Trademarks

D-CAP2™ is a trademark of Texas Instruments.

All trademarks are the property of their respective owners.

1 Description

The TPS53819AEVM-123 is designed to use a regulated 12-V bus to produce a regulated 1.2-V output at up to 25 A of load current. The TPS53819AEVM-123 is designed to demonstrate the TPS53819A in a typical low voltage application while providing a number of test points to evaluate the performance of the TPS53819A.

1.1 Typical Applications

- Point of load systems
- Storage computer
- Server computer
- Multi-function printer
- Embedded computing

1.2 Features

- Regulated 1.2-V output, marginable and trimmable through the PMBus interface

- 25-A DC steady state output current
- D-CAP2™ mode control supporting all ceramic output capacitors
- Programmable soft start through the PMBus interface
- Programmable enable function through the PMBus interface
- Fault report through the PMBus interface
- J2 for external enable function
- Supports pre-bias output voltage start-up
- High efficiency and high-power density by using a TI power block MOSFET
- Convenient test points for probing critical waveforms
- Cycle-by-cycle valley overcurrent limit protection

2 Electrical Performance Specifications

Table 2-1. TPS53819AEM-123 Electrical Performance Specifications⁽¹⁾

PARAMETER	TEST CONDITIONS	MIN	TYP	MAX	UNITS
INPUT CHARACTERISTICS					
Voltage range, V_{IN}		8	12	14	V
Maximum input current	$V_{IN} = 8\text{ V}$, $I_{OUT} = 25\text{ A}$		4.3		A
No load input current	$V_{IN} = 14\text{ V}$, $I_{OUT} = 0\text{ A}$ with auto skip mode		1		mA
OUTPUT CHARACTERISTICS					
Output voltage, V_{OUT}			1.2		V
Output load current, I_{OUT}		0		25	A
Output voltage regulation	Line regulation: input voltage = 8 V to 14 V		0.5%		
	Load regulation: output current = 0 A to 25 A		0.5%		
Output voltage ripple	$V_{IN} = 12\text{ V}$, $I_{OUT} = 25\text{ A}$		10		mVpp
Output over current	I_{OUT_OC} fault flag asserted	25			A
SYSTEMS CHARACTERISTICS					
Switching frequency			425		kHz
Peak efficiency	$V_{IN} = 12\text{ V}$, $I_{OUT} = 10\text{ A}$		91.0%		
Full load efficiency	$V_{IN} = 12\text{ V}$, $I_{OUT} = 25\text{ A}$		87.9%		
Loop bandwidth	$V_{IN} = 12\text{ V}$, $I_{OUT} = 25\text{ A}$		111		kHz
Phase margin	$V_{IN} = 12\text{ V}$, $I_{OUT} = 25\text{ A}$		91.4		°
Operating temperature			25		°C

(1) This design uses TI Default PMBus settings

3 Schematic

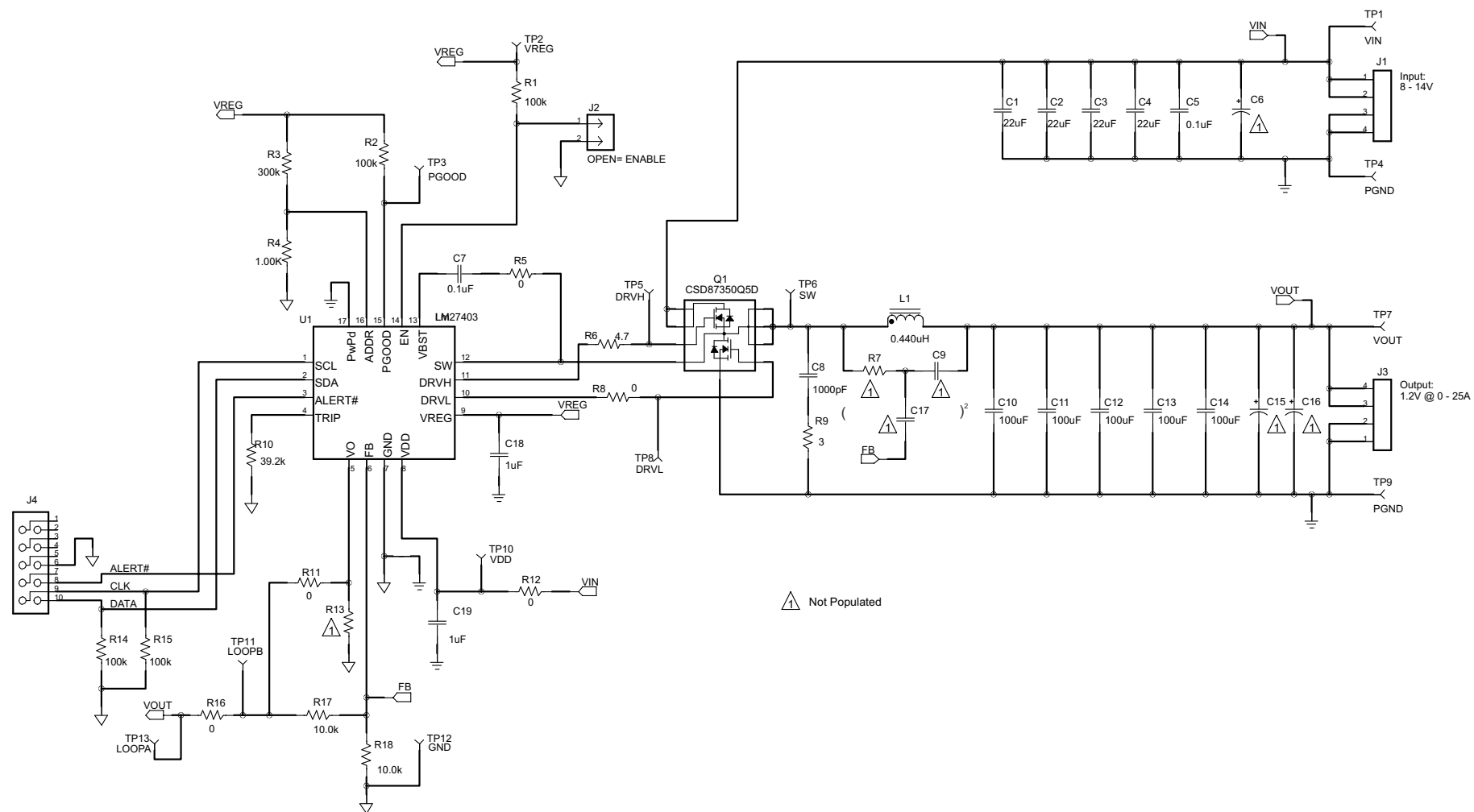

Figure 3-1. TPS53819AEVM-123 Schematic

4 Test Setup

4.1 Test and Configuration Software

In order to change any of the default configuration parameters on the EVM, it is necessary to obtain the TI Fusion Digital Power Designer software.

4.1.1 Description

Fusion Digital Power Designer is the Graphical User Interface (GUI) used to configure and monitor Texas Instrument's (TI) TPS53819A power controller on this evaluation module (EVM). The application uses the PMBus protocol to communicate with the controller over serial bus by way of a TI USB Interface Adapter EVM included.

4.1.2 Features

Some of the tasks performed with the GUI include:

- Turn on or off the power supply output, either through the hardware control line or the PMBus operation command.
- Configure common operating characteristics such as V_{OUT} , switching frequency, soft-start time, and more.
- Monitor status and warnings or fault conditions real-time.

The software is available for download at this location:

http://focus.ti.com/docs/toolsw/folders/print/fusion_digital_power_designer.html.

4.2 Test Equipment

Voltage Source: The input voltage source V_{IN} should be a 0-V to 14-V variable DC source capable of supplying 30 ADC. Connect V_{IN} to J4 as shown in [Figure 4-2](#).

Multimeters:

- **V1:** V_{IN} at TP1 (V_{IN}) to TP4 (PGND)
- **V2:** V_{OUT} at TP7 (V_{OUT}) to TP9 (PGND)
- **A1:** V_{IN} input current

Output Load: The output load should be an electronic constant-resistance mode load capable of 0 ADC to 25 ADC at 1.2 V. An electronic constant-current load is also acceptable.

Oscilloscope: A digital or analog oscilloscope can be used to measure the output ripple. The oscilloscope must be set for 1-M Ω impedance, 20-MHz bandwidth, AC coupling, 2- μ s per division horizontal resolution, 20-mV per division vertical resolution. As shown in [Figure 4-1](#), test points TP7 and TP9 can be used to measure the output ripple voltage by placing the oscilloscope probe tip through TP7 and holding the ground barrel to TP9. It is not recommended to use a long leaded ground connection because this may induce additional noise due to a large ground loop. Alternatively, the output ripple can be measured directly across C14 with a short ground lead as shown in [Figure 4-2](#). To measure other waveforms, adjust the oscilloscope as needed.

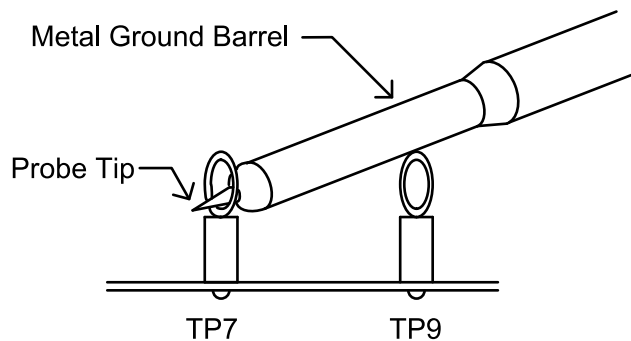

Figure 4-1. Tip and Barrel Measurement for V_{OUT} Ripple

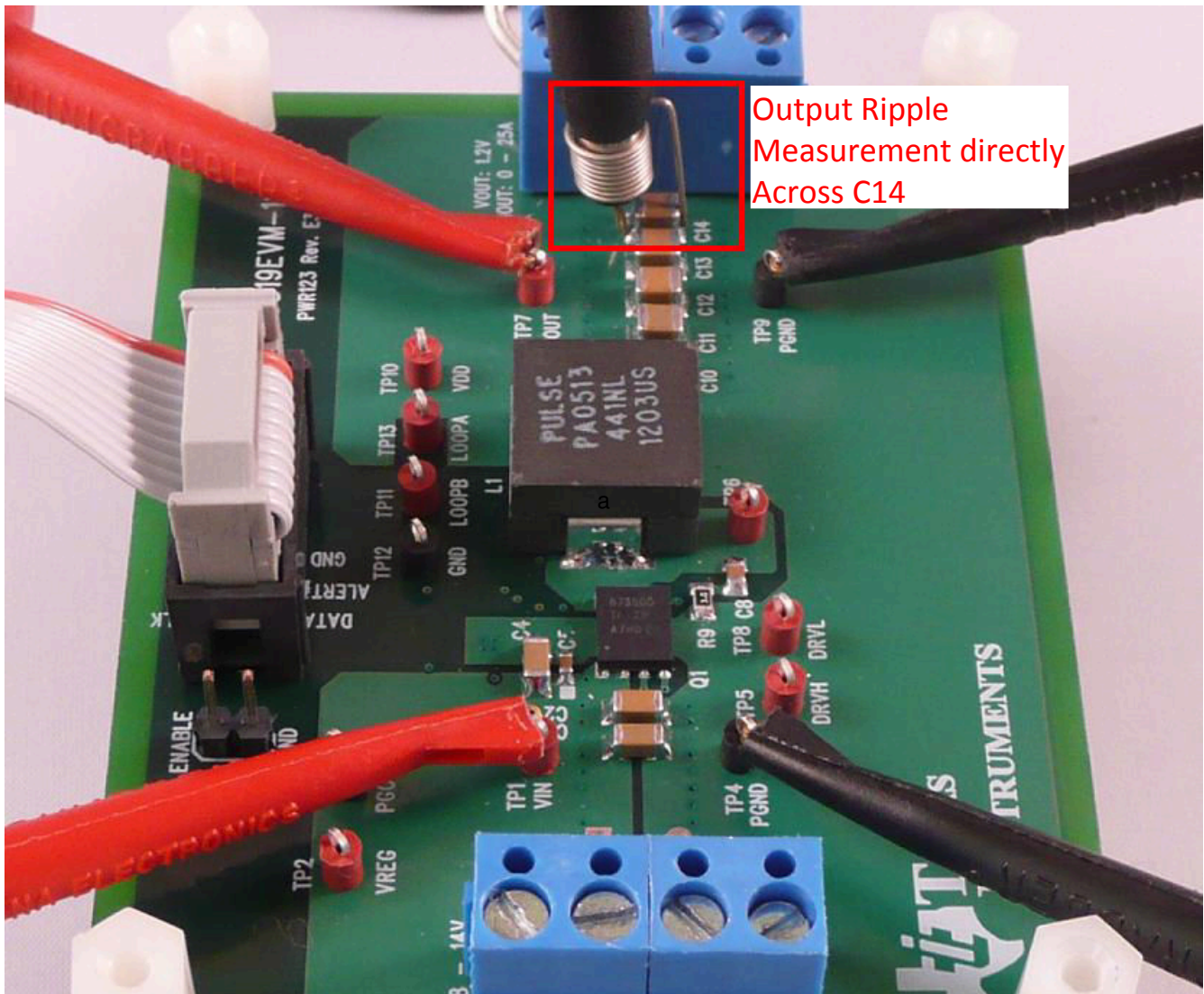

Figure 4-2. Probe with Short Ground Lead for V_{OUT} Ripple Across C14

Fan: Some of the components of this EVM can approach temperatures of 60°C during operation. A small fan capable of 200–400 LFM is recommended to reduce component temperatures while the EVM is operating. Exercise caution when touching the EVM while the fan is not running and always exercise caution when touching any circuits that can be live or energized.

Recommended Wire Gauge:

- **V_{IN} to J1 (12-V input):** The recommended wire size is 1 × AWG #14 per input connection, with the total length of wire less than four feet (two feet input, two feet return).
- **J3 to LOAD:** The minimum recommended wire size is 2 × AWG #14, with the total length of wire less than four feet (two feet input, two feet return).

4.3 Recommended Test Setup

Figure 4-3 is the recommended test set up to evaluate the TPS53819AEVM-123. Working at an ESD workstation, make sure that any wrist straps, bootstraps or mats are connected referencing the user to earth ground before power is applied to the EVM.

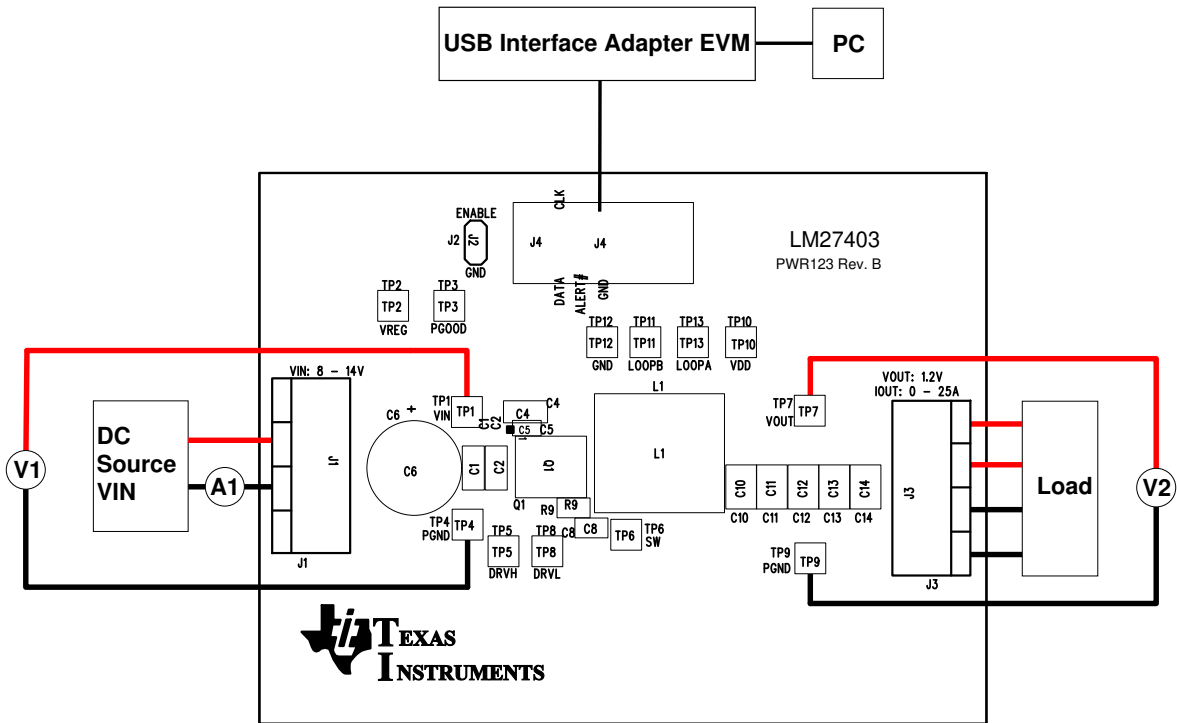

Figure 4-3. TPS53819AEMV-123 Recommended Test Setup

4.3.1 Input Connections

1. Prior to connecting the DC input source V_{IN} , it is advisable to limit the source current from V_{IN} to 10-A maximum. Make sure V_{IN} is initially set to 0 V and connected to J1 as shown in Figure 4-3.
2. Connect a voltmeter V1 at TP1 and TP4 to measure the input voltage.
3. Connect a current meter to A1 to measure the input current.

4.3.2 Output Connections

1. Connect Load to J3 and set Load to constant resistance mode to sink 0 Adc before V_{IN} is applied.
2. Connect a voltmeter V2 at TP7 and TP9 to measure the output voltage.

4.3.3 Other Connections

1. When using a fan, ensure air is flowing across the EVM.
2. Connect the ribbon cable from the USB interface adapter to J4.

4.4 List of Test Points

Table 4-1. The Functions of Each Test Points

TEST POINTS	NAME	DESCRIPTION
TP1	VIN	Input voltage
TP2	VREG	5-V LDO output
TP3	PGOOD	Power good
TP4	PGND	GND reference for V_{IN}
TP5	DRVH	High-side driver output
TP6	SW	Switching node
TP7	VOUT	Output voltage
TP8	DRVL	Low-side driver output
TP9	PGND	GND reference for VOUT
TP10	VDD	Controller power-supply input
TP11	LOOPB	Input B for loop injection
TP12	GND	GND for sensitive analog circuitry

Table 4-1. The Functions of Each Test Points (continued)

TEST POINTS	NAME	DESCRIPTION
TP13	LOOPA	Input A for loop injection

4.5 Jumper Configuration: Enable Selection

The controller can be enabled and disabled by J3.

Default setting: No Jumper shorts on J3 to Enable the controller.

Table 4-2. Enable Selection

JUMPER POSITION	ENABLE SELECTION
Jumper shorts on J3	Disable the controller
No jumper shorts on J3	Enable the controller

5 EVM Configuration Using the Fusion GUI

In order to configure the TPS53819A controller on the EVM from its default values, it is required to use the TI Fusion Digital Power Designer software. It is necessary to have input voltage applied to the EVM prior to launching the software so the TPS53819A can respond to the GUI and the GUI can recognize the TPS53819A. At least 4.25 V must be applied to the V_{DD} pin to overcome the default UVLO setting.

5.1 Configuration Procedure

1. Adjust the input supply to provide at least 4.25 V.
2. Apply the input voltage to the EVM. Refer to [Figure 4-3](#) for connections and test setup.
3. Launch the Fusion GUI software. If prompted, select GUI scan mode to *DEVICE_CODE* only. Refer to [Figure 5-1](#) for changing device scanning options. The software will recognize the TPS53819A device on the EVM and load the GUI.
4. Configure the EVM operating parameters as needed.

CAUTION

Some parameters can be configured, such as switching frequency, to values that can result in erratic or unexpected behavior on this EVM. Consult the [TPS53819A 3-V to 28-V Input, 40-A, Eco-Mode™, D-CAP2™ Synchrons Buck Controller Data Sheet](#) for guidance in configuration of parameters and impact on component selection.

Figure 5-1. Selection of Device Scan Options

5.2 Default Fusion GUI Screenshots and Description

[Figure 5-2](#) is a screenshot of the *General* tab of the Fusion GUI with default configuration where the general configuration parameters can be set. After modifying a parameter the **Write to Hardware** button must be clicked to apply it. When power cycling all parameters reset to the values stored in flash. To change the values stored in flash, click the **Store RAM to Flash** button. [Figure 5-3](#) is a screenshot of the *All Config* tab where all accessible registers are viewed. [Figure 5-4](#) is a screenshot of the Status screen selected on the bottom-left corner. The USB adapter settings are found in the File menu of the Digital Fusion GUI.

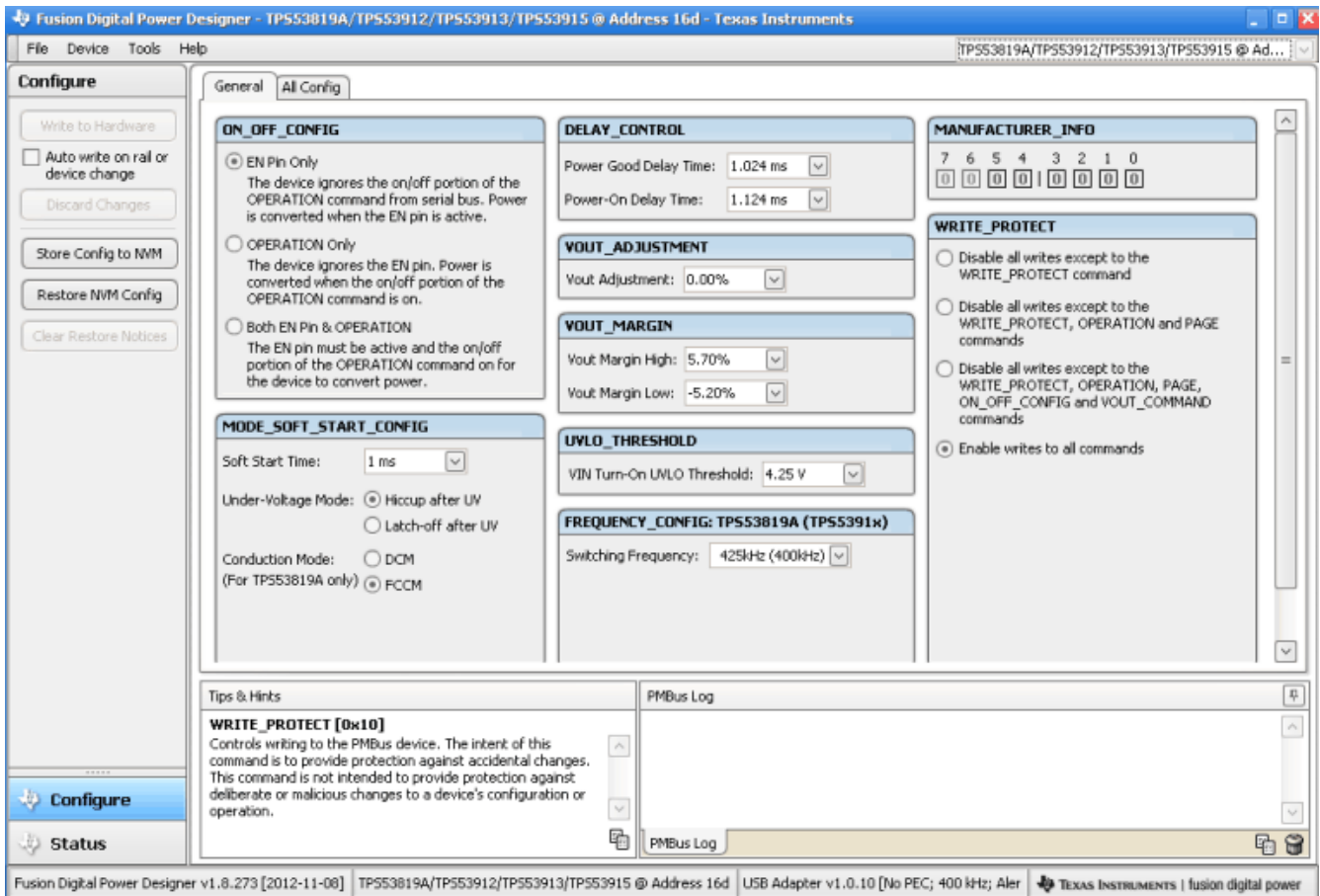

Figure 5-2. TPS53819A GUI Configure General Tab

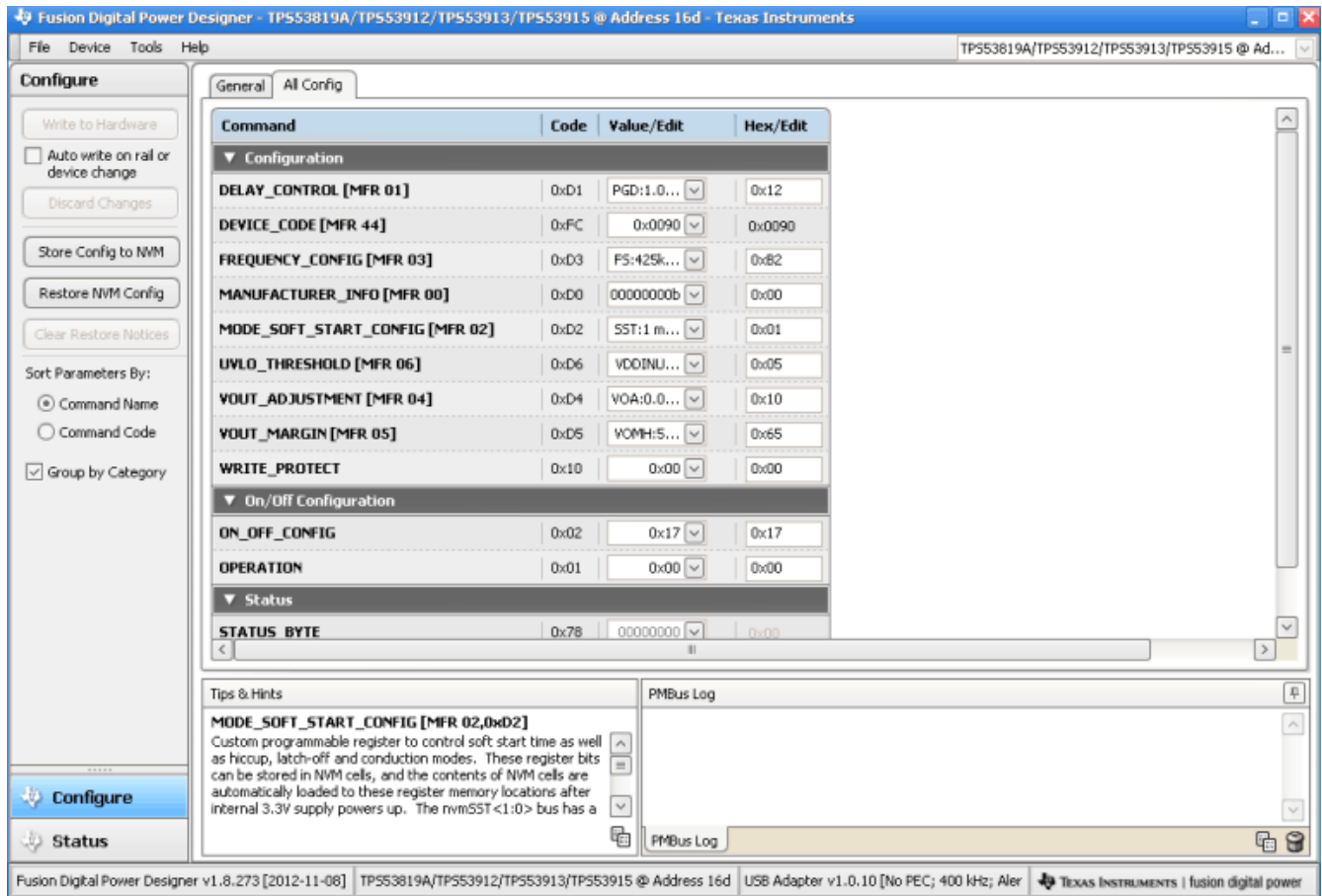

Figure 5-3. TPS53819A GUI Configure, All Config Tab

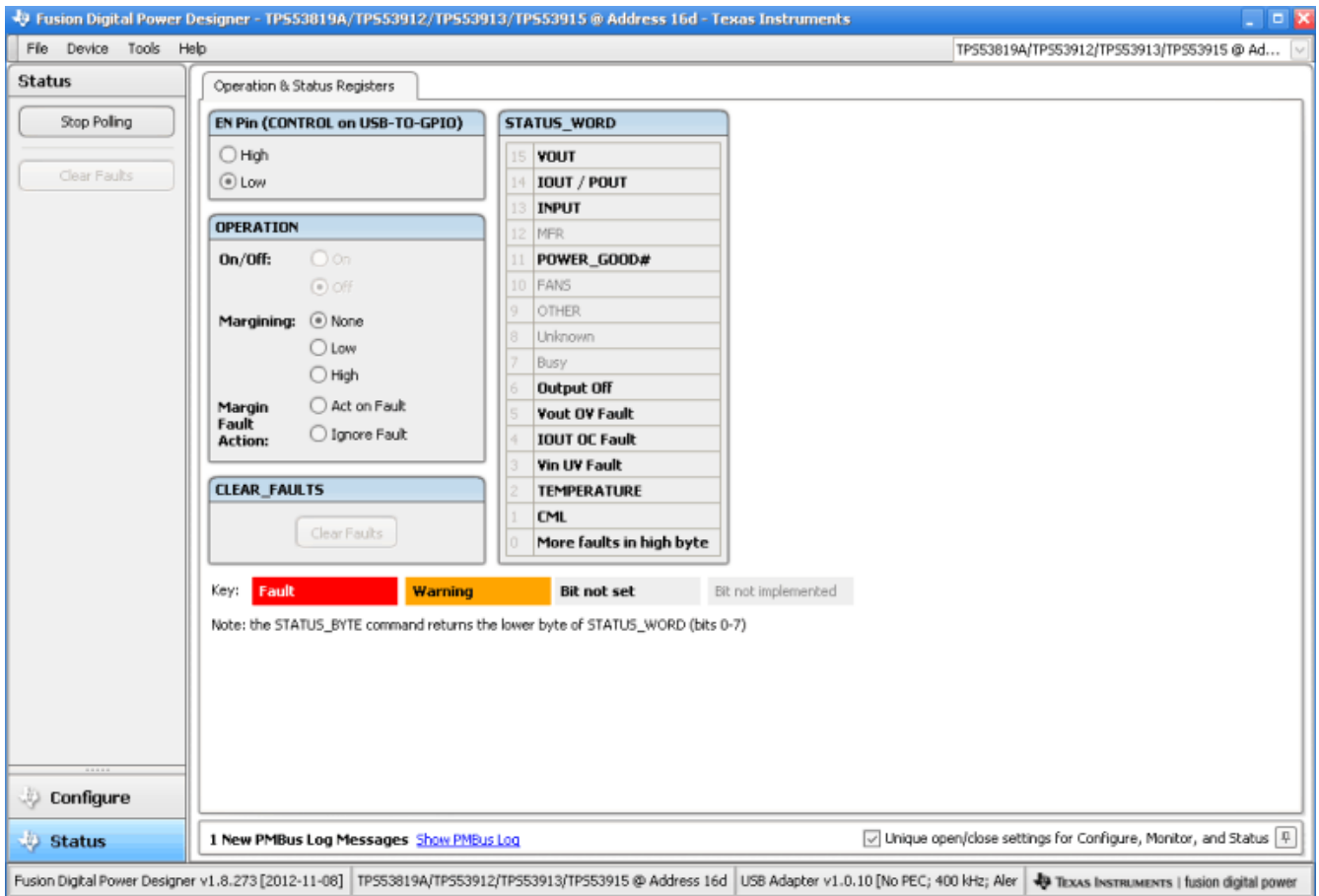

Figure 5-4. TPS53819A GUI Status

6 Test Procedure

6.1 Line and Load Regulation and Efficiency Measurement Procedure

1. Set up the EVM as described in [Section 4](#) and [Figure 4-3](#).
2. Ensure the load is set to constant resistance mode and to sink 0 ADC.
3. Ensure the jumper provided in the EVM shorts on J2 before V_{IN} is applied.
4. Increase V_{IN} from 0 V to 12 V, using V1 to measure input voltage.
5. Remove the jumper on J3 to enable the controller.
6. Use V2 to measure V_{OUT} voltage.
7. Vary Load from 0 ADC to 25 ADC. V_{OUT} should remain in load regulation.
8. Vary V_{IN} from 8 V to 14 V. V_{OUT} should remain in line regulation.
9. Put the jumper on J3 to disable the controller.
10. Decrease the load to 0 A.
11. Decrease V_{IN} to 0 V.

6.2 Control Loop Gain and Phase Measurement Procedure

TPS53819AEVM-123 contains a place holder for a 10- Ω series resistor in the feedback loop for loop response analysis.

1. Replace R16 with a 10- Ω resistor.
2. Set up EVM as described in [Section 4](#) and [Figure 4-3](#).
3. Connect isolation transformer to test points marked TP13 and TP11.
4. Connect input signal amplitude measurement probe (Loop B) to TP11. Connect output signal amplitude measurement probe (Loop A) to TP13.
5. Connect ground lead of Loop A and Loop B to TP12.
6. Inject around 10 mV or less signal through the isolation transformer.
7. Sweep the frequency from 100 Hz to 1 MHz with 10 Hz or lower post filter. The control loop gain and phase margin can be measured.
8. Disconnect isolation transformer from bode plot test points before making other measurements (Signal injection into feedback can interfere with accuracy of other measurements).

6.3 Equipment Shutdown

1. Shut down the load.
2. Shut down V_{IN} .
3. Shut down fan.

7 Performance Data and Typical Characteristic Curves

Figure 7-1 through Figure 7-4 present typical performance curves for TPS53819AEVM-123.

7.1 Efficiency

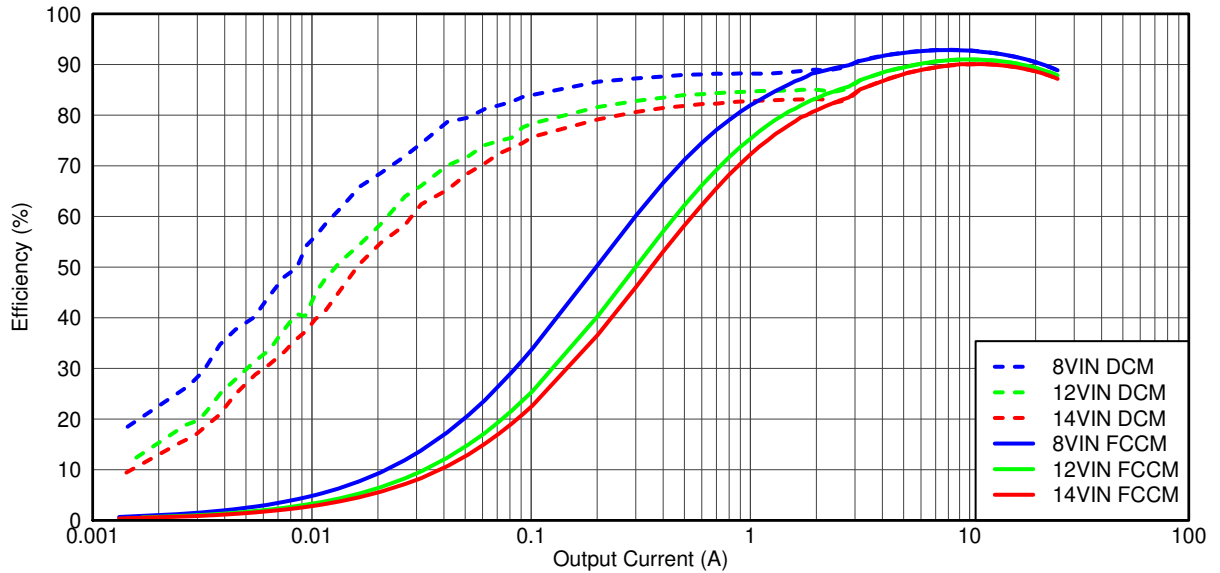

Figure 7-1. TPS53819AEVM-123 Efficiency

7.2 Load Regulation

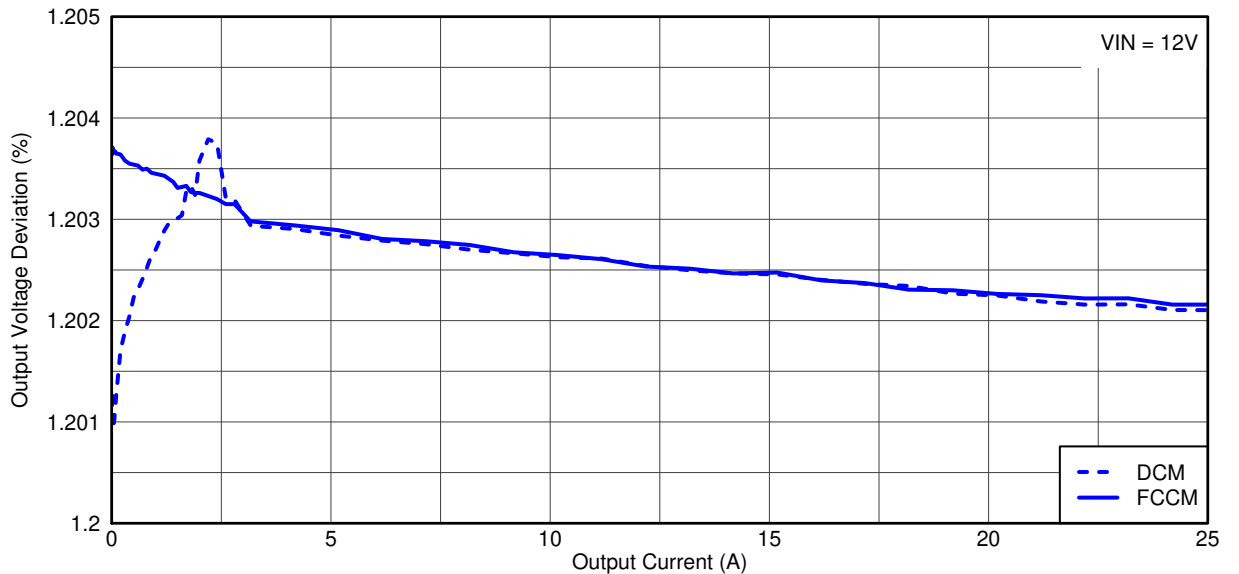

Figure 7-2. TPS53819AEVM-123 Load Regulation

7.3 Line Regulation

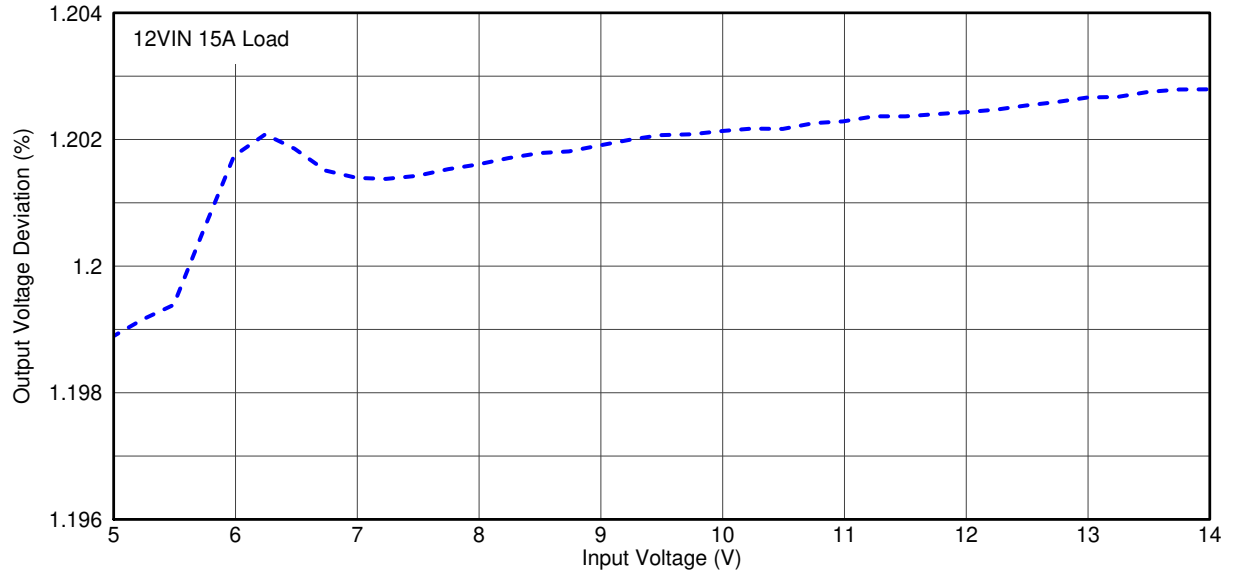

Figure 7-3. TPS53819AEVM-123 Line Regulation

7.4 f_{sw} Versus Load

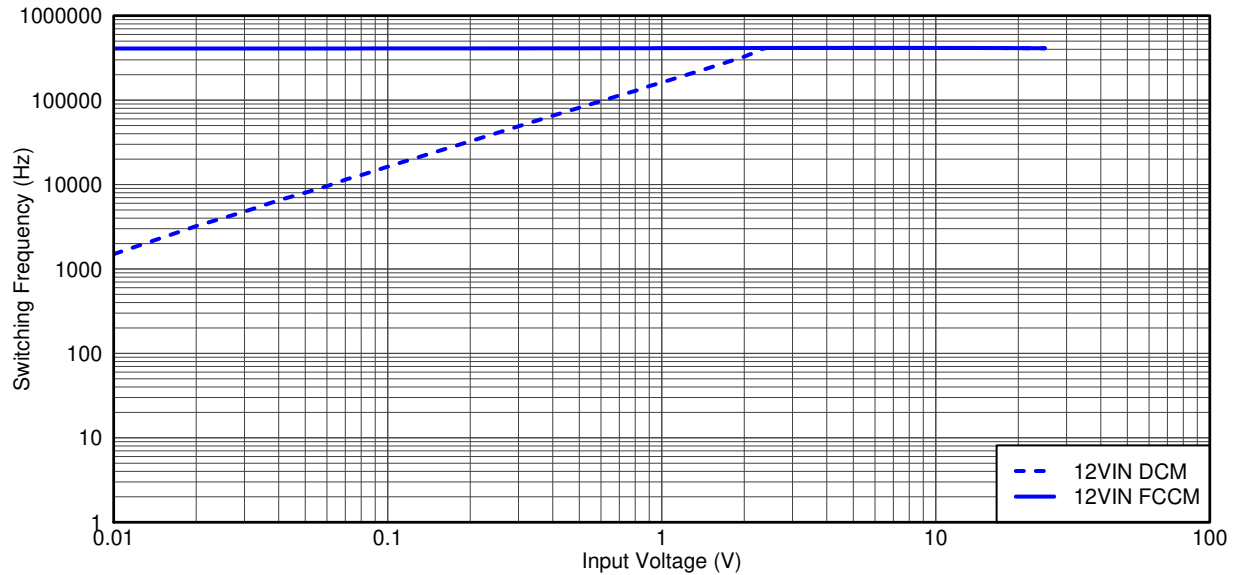

Figure 7-4. TPS53819AEVM-123 f_{sw} Versus Load

7.5 Bode Plot

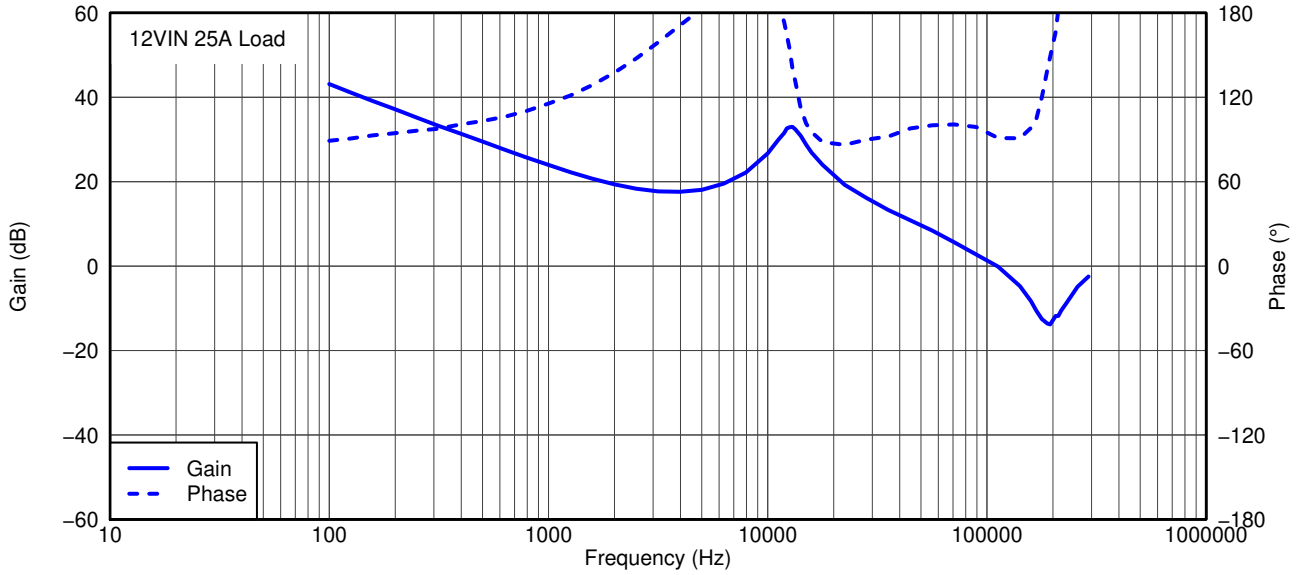

Figure 7-5. TPS53819AEVM-123 Loop Response Gain and Phase

7.6 Transient Response

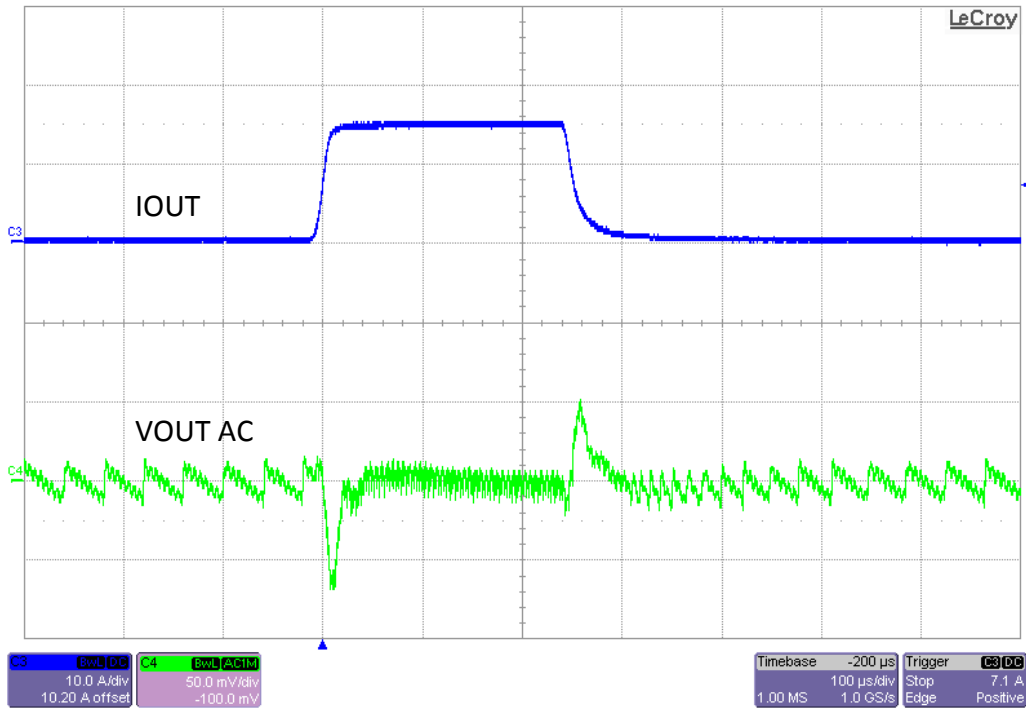

Figure 7-6. TPS53819AEVM-123 Load Transient, 12 V_{IN}, 0-A to 15-A Eco-mode

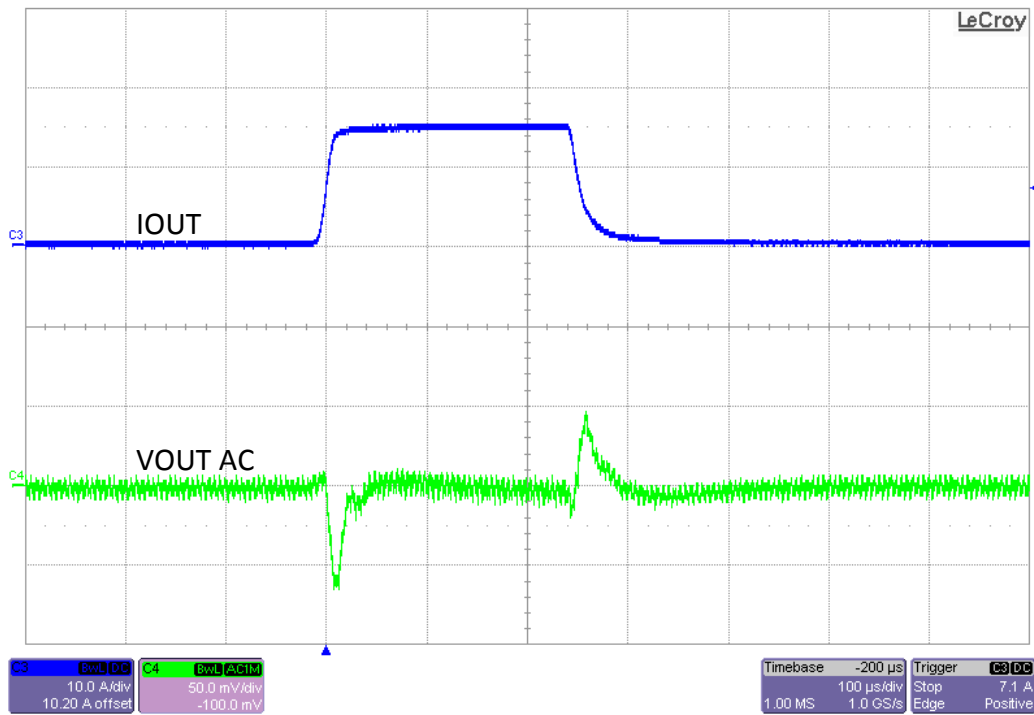

Figure 7-7. TPS53819AEM-123 Load Transient, 12 V_{IN}, 0-A to 15-A FCCM

7.7 Output Ripple

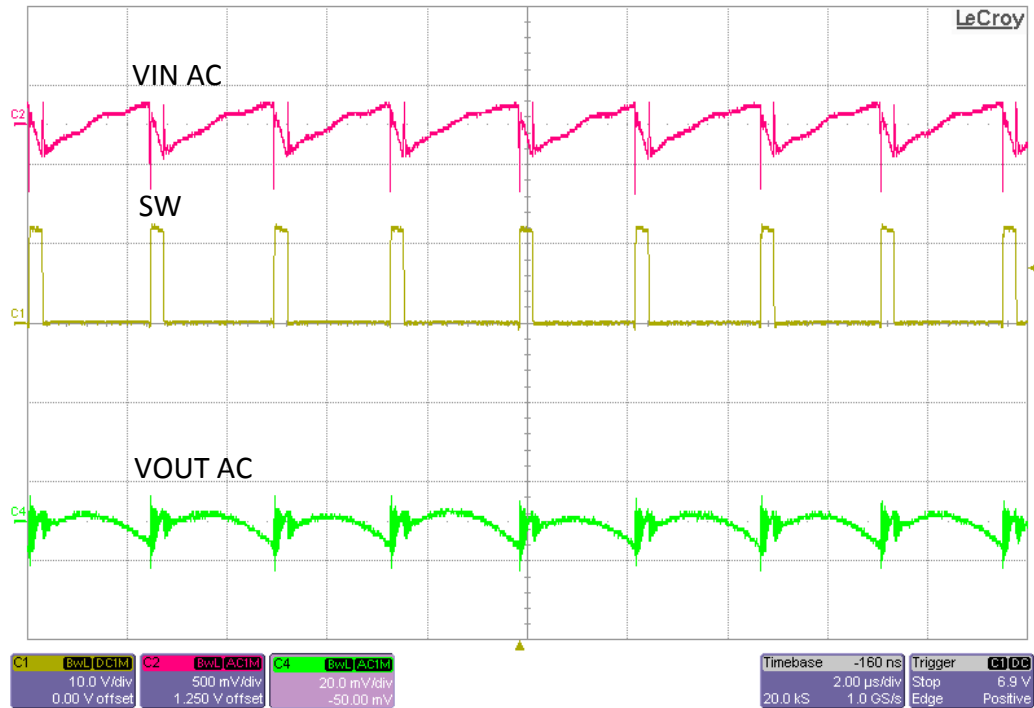

Figure 7-8. TPS53819AEM-123 Output Ripple, 12 V_{IN}, 25 A

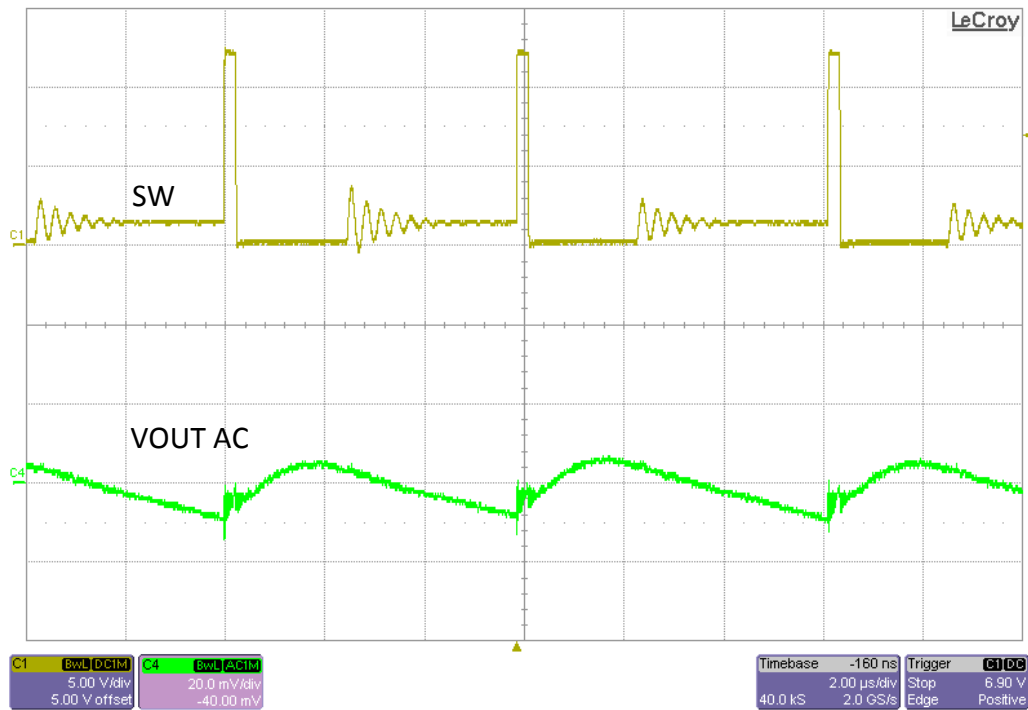

Figure 7-9. TPS53819AEM-123 Output Ripple, 12 V_{IN}, 1-A Load Eco-mode

7.8 Switching Node

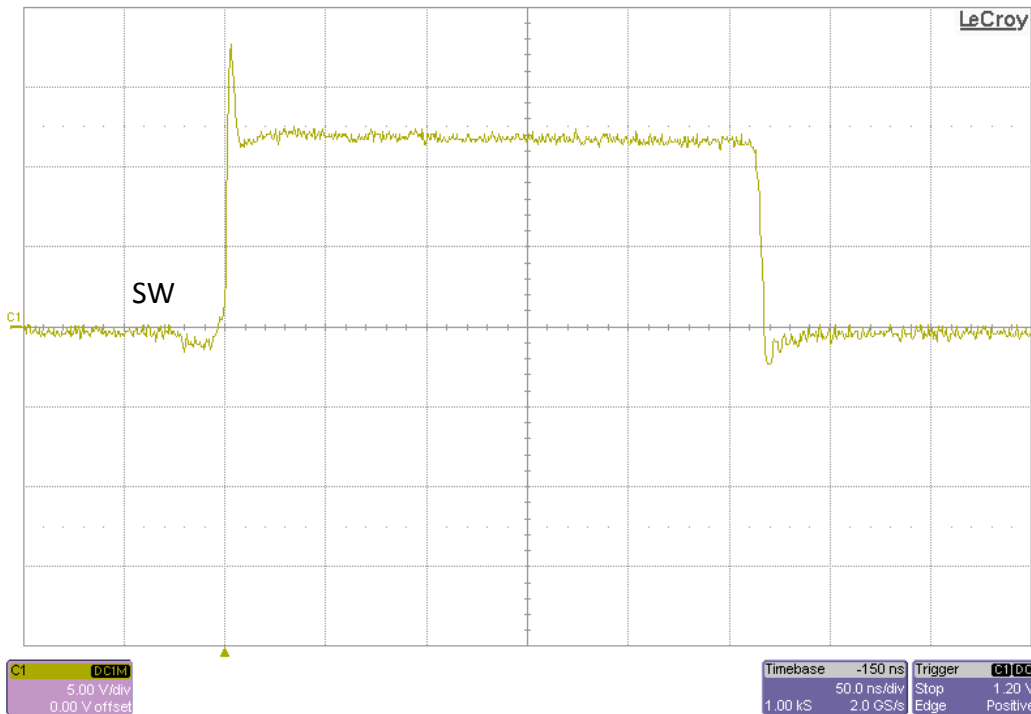

Figure 7-10. TPS53819AEM-123 Switching Node, 12-V_{IN}, 25-A Load Full Bandwidth

7.9 Turn-On Waveform

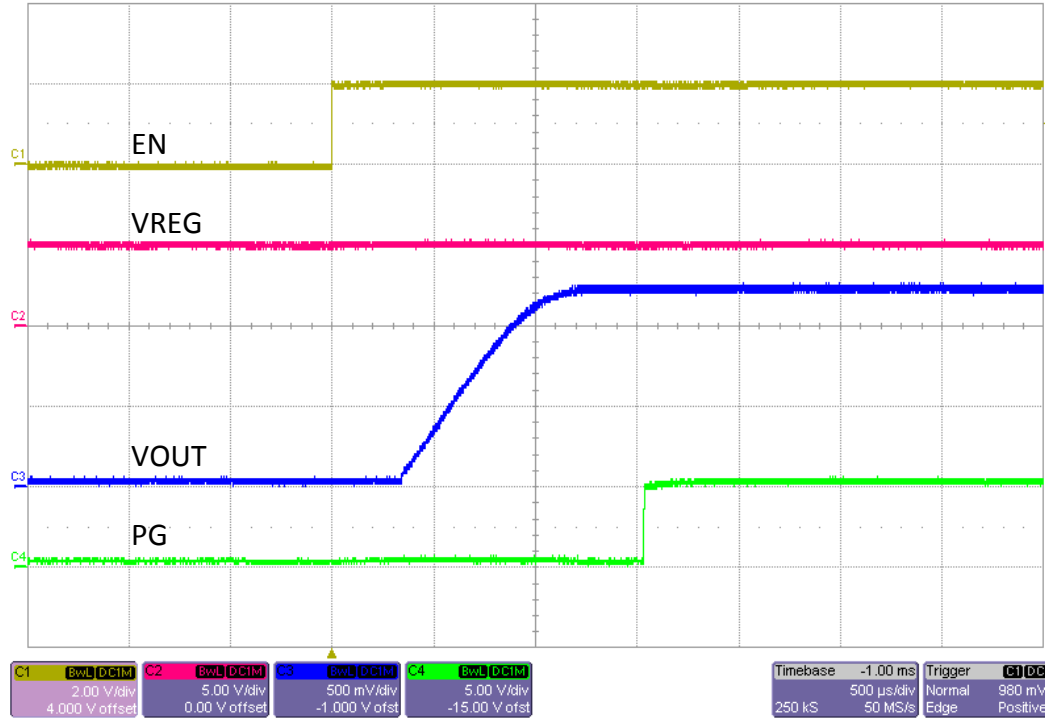

Figure 7-11. TPS53819AEVM-123 Enable Turn-On Waveform, 12-V_{IN}, 1- Ω Load

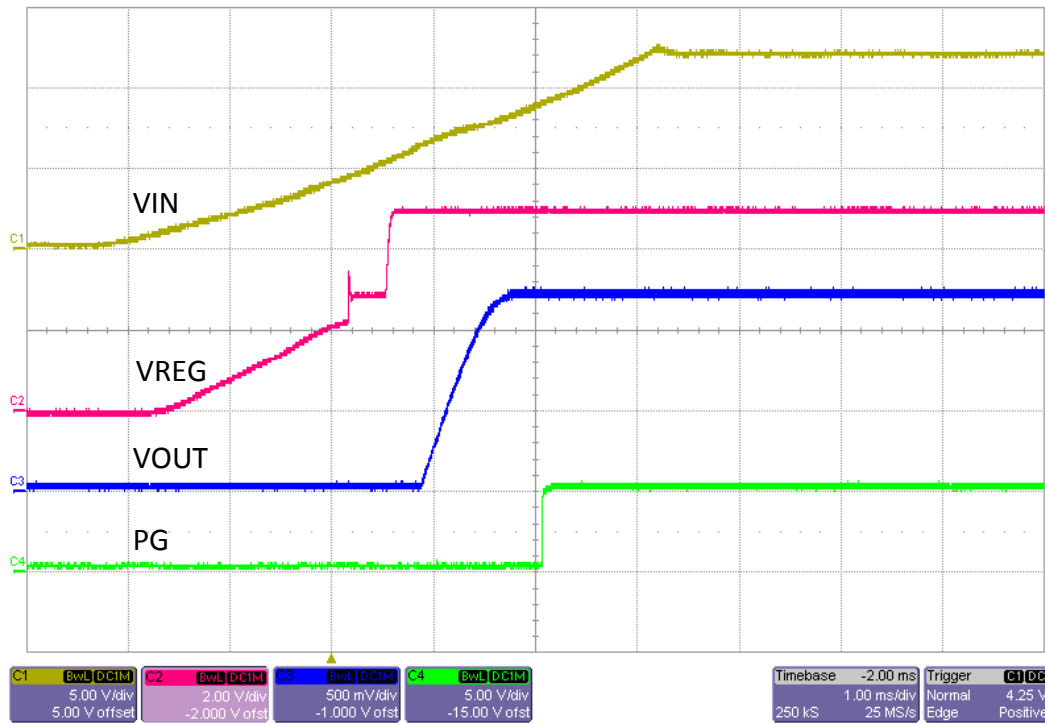

Figure 7-12. TPS53819AEVM-123 V_{IN} Turn-On Waveform, 12-V_{IN}, 1- Ω Load

7.10 Turn-Off Waveform

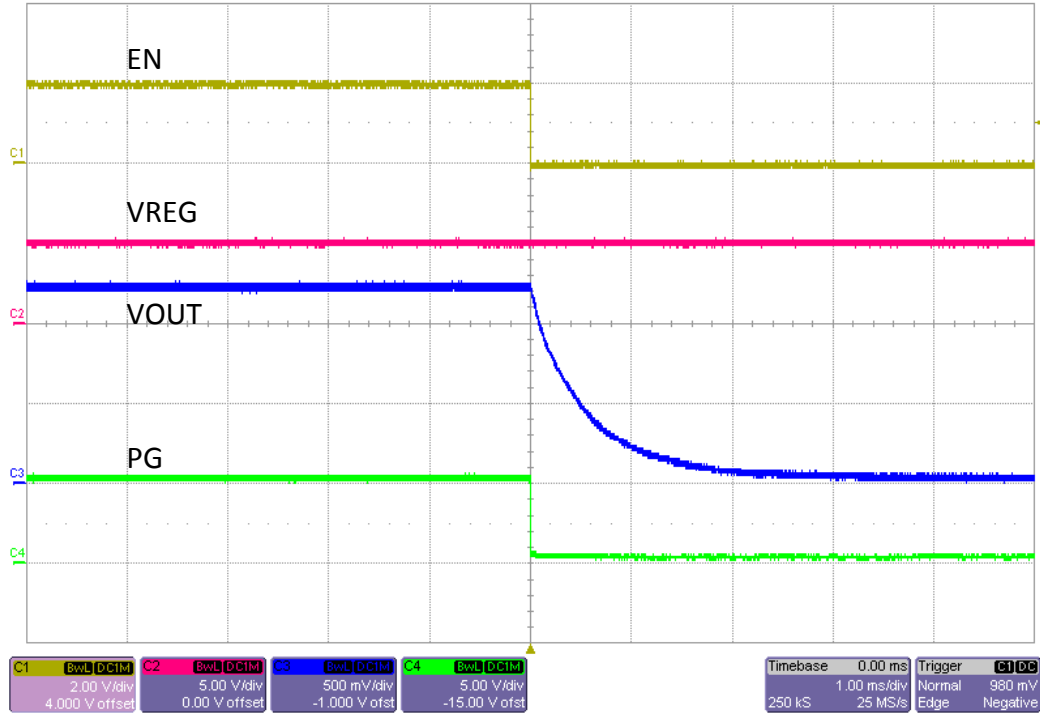

Figure 7-13. TPS53819AEVM-123 Enable Turn-Off Waveform, 12 V_{IN}, 1-Ω Load

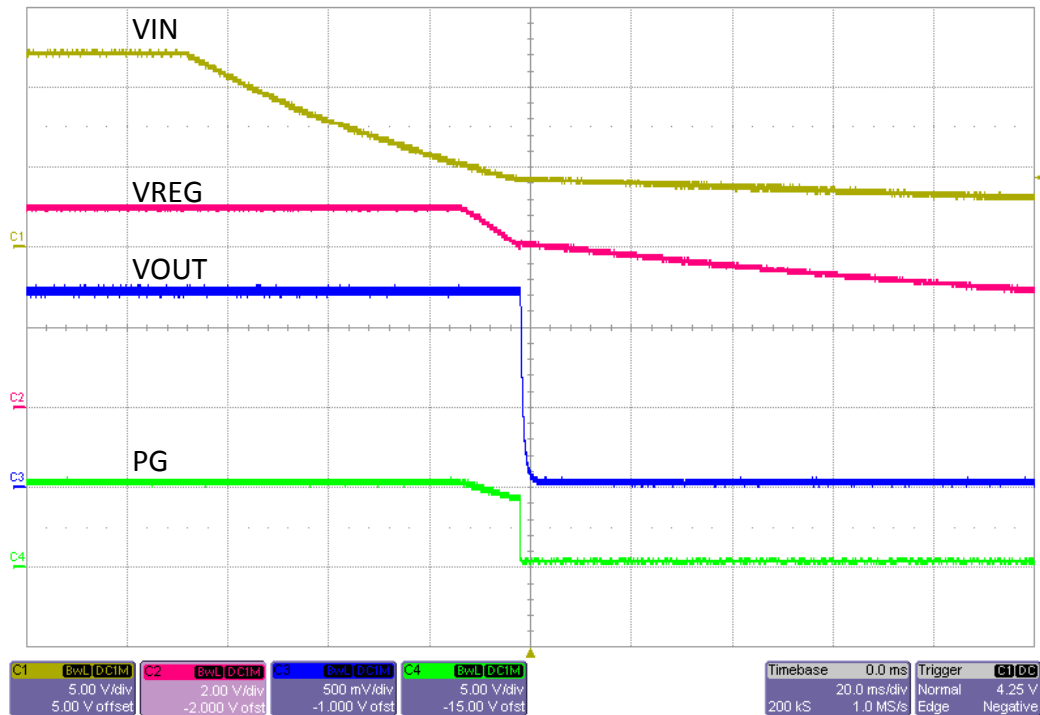

Figure 7-14. TPS53819AEVM-123 V_{IN} Turn off Waveform, 12 V_{IN}, 1-Ω Load

7.11 Pre-bias Turn-On Waveform

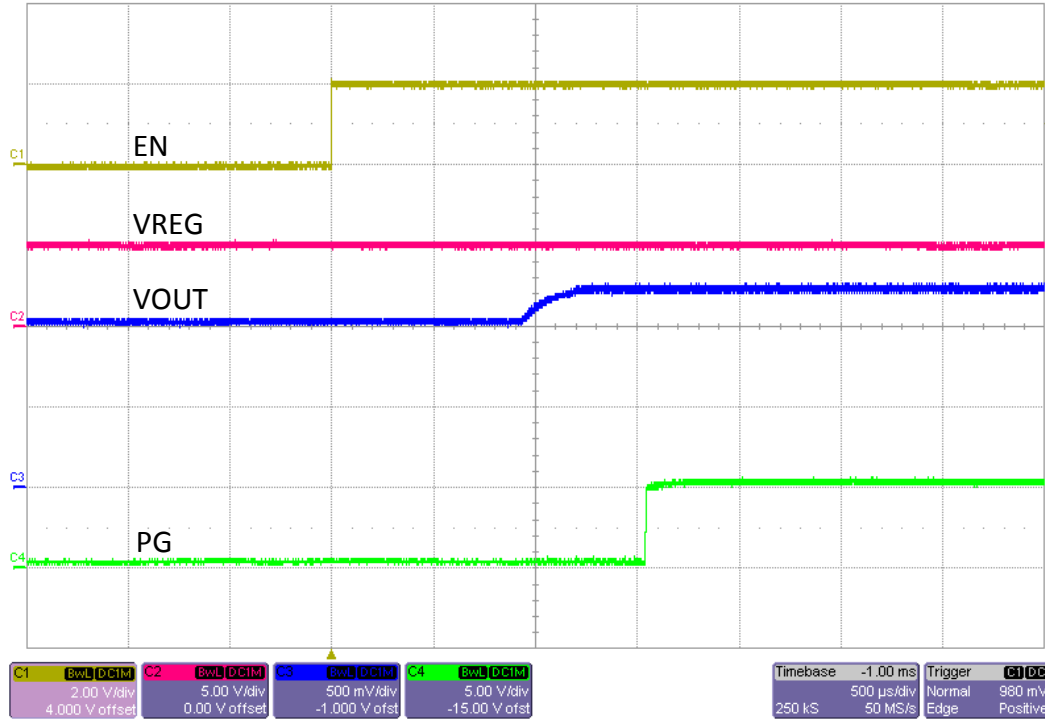
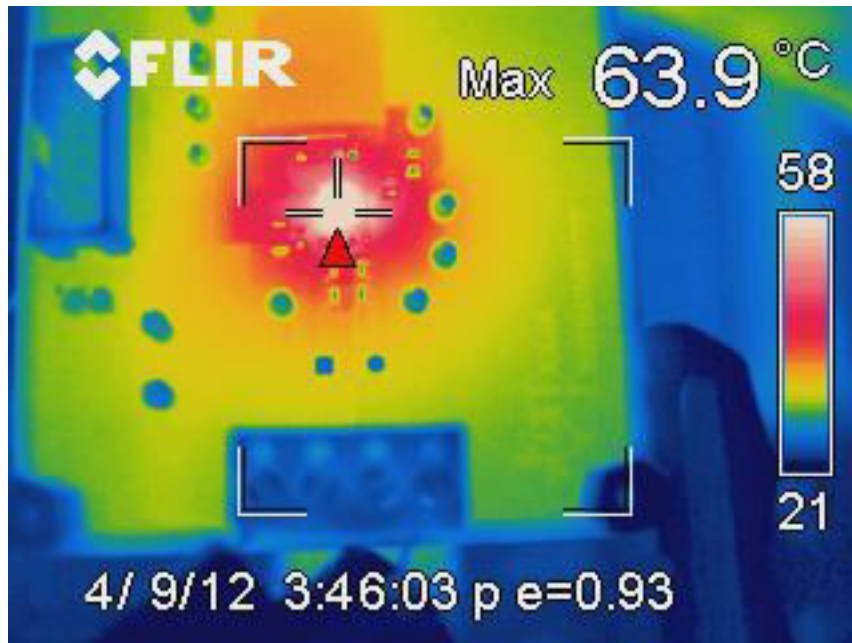

Figure 7-15. TPS53819AEVM-123 Enable Turn-On Waveform, 12 V_{IN}, 1- Ω Load, 1-V Pre-bias

7.12 Thermal Images



Hottest point is the CSD87350Q5D

Figure 7-16. TPS53819AEVM-123 Top Board, 12 V_{IN}, 25-A Fan

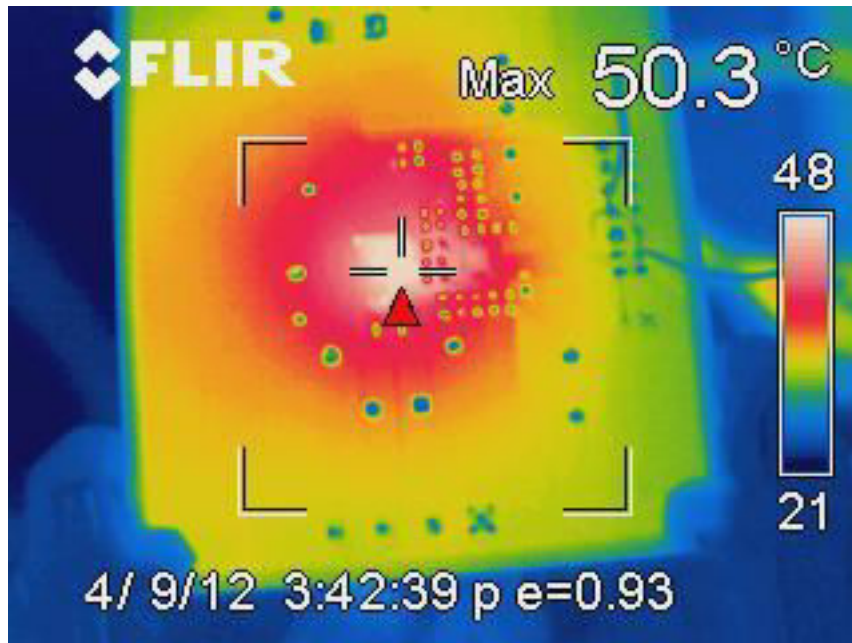

Hottest point is below the CSD87350Q5D

Figure 7-17. TPS53819AEVM-123 Bottom Board, 12 V_{IN}, 25-A Fan

8 EVM Assembly Drawing and PCB layout

Figure 8-1 through Figure 8-8 show the design of the TPS53819AEVM-123 printed-circuit board (PCB). The EVM has been designed using six layers, 2-oz copper circuit board.

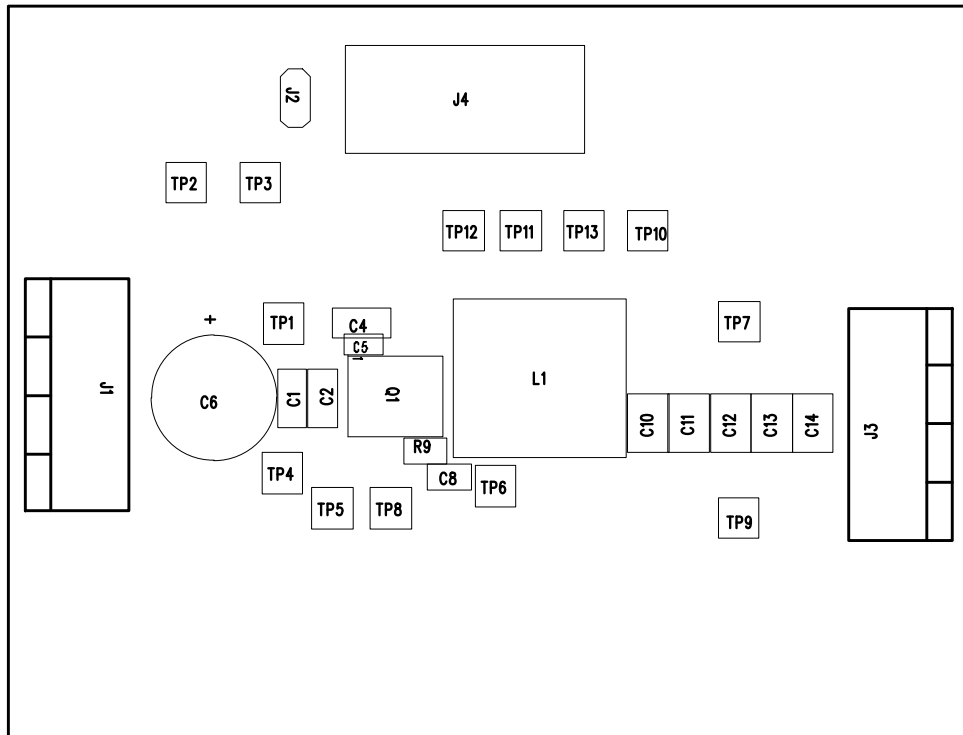

Figure 8-1. TPS53819AEVM-123 Top Layer Assembly Drawing (Top View)

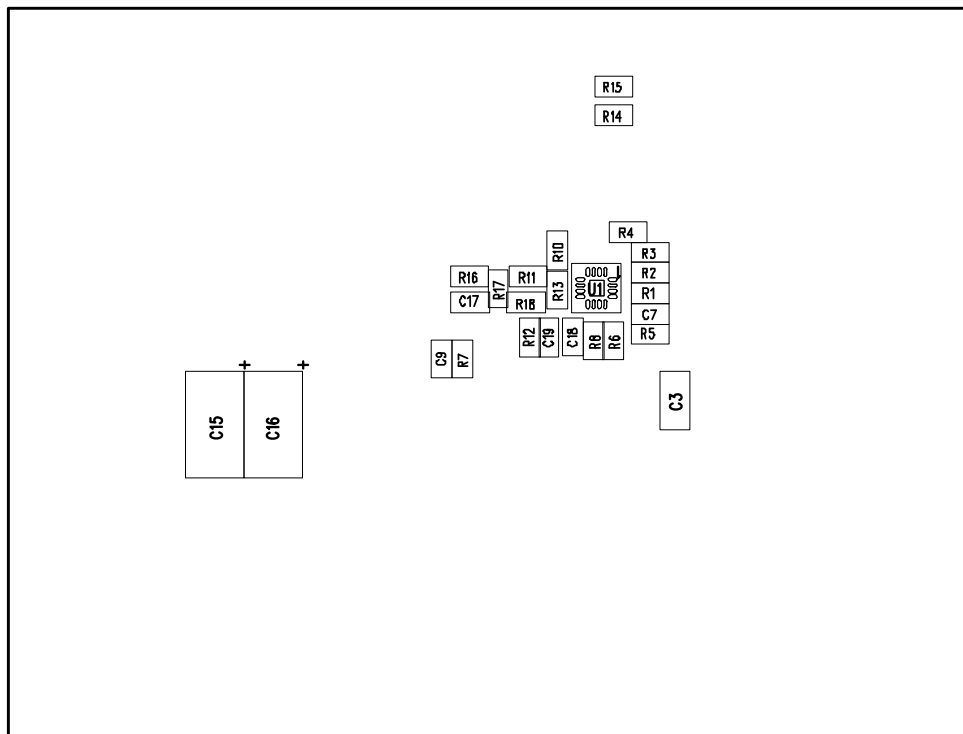

Figure 8-2. TPS53819AEVM-123 Bottom Layer Assembly Drawing (Bottom View)

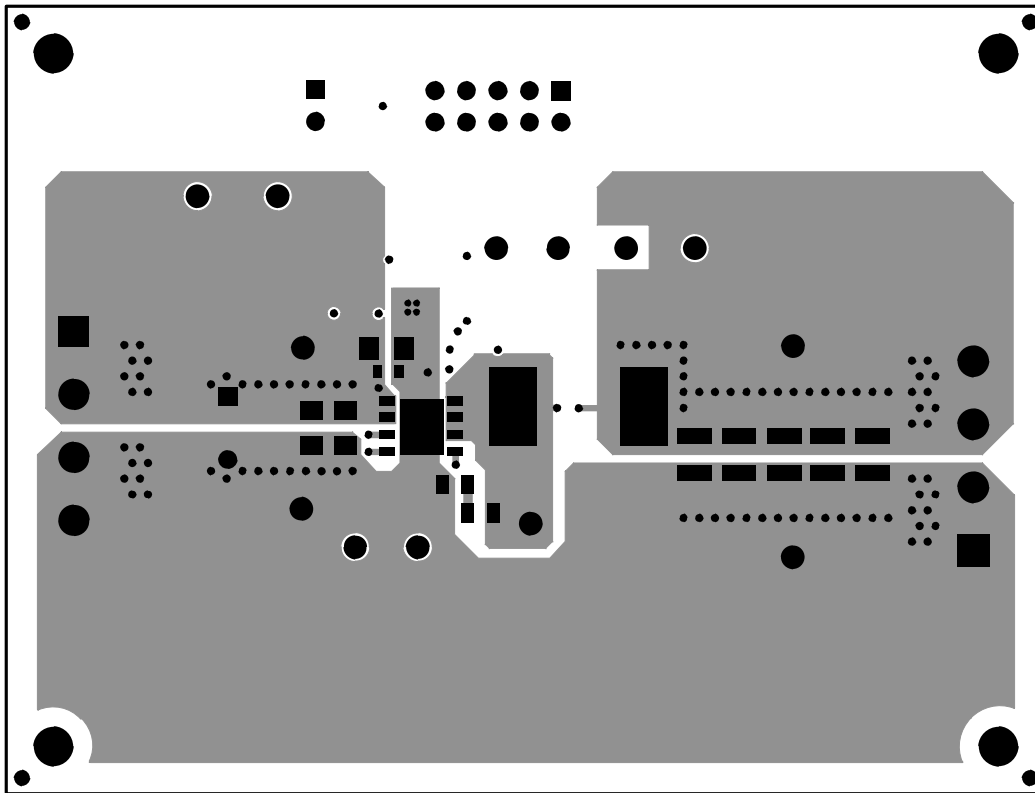

Figure 8-3. TPS53819AEVM-123 Top Copper (Top View)

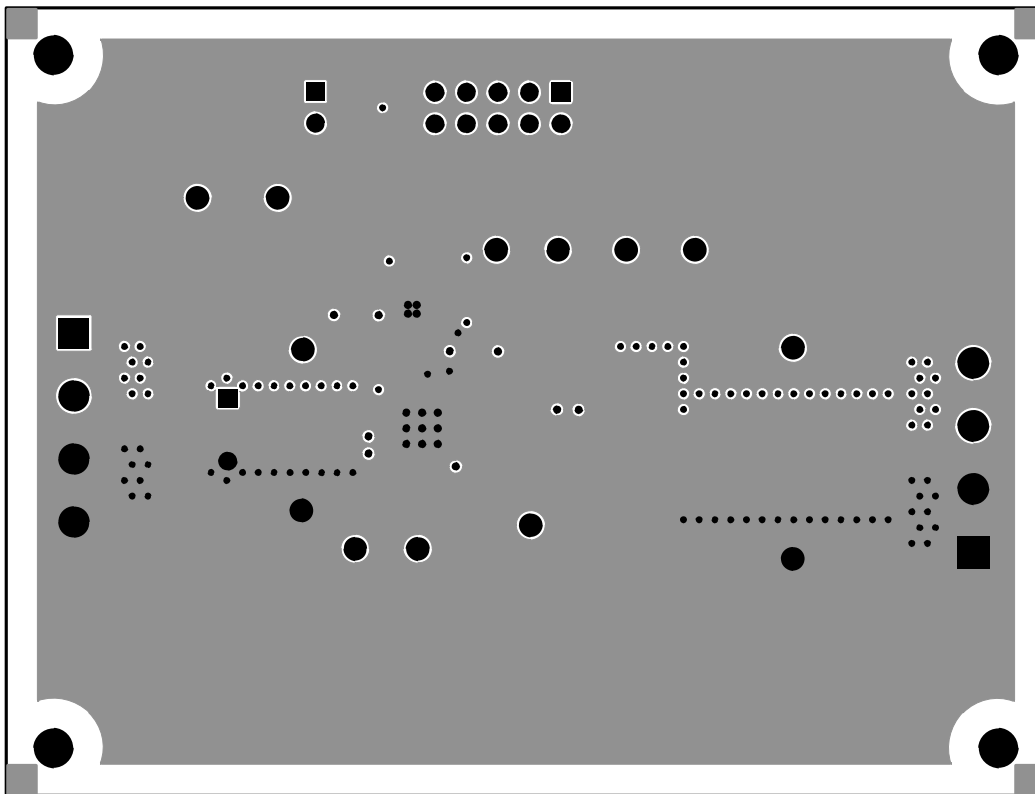

Figure 8-4. TPS53819AEVM-123 Internal Layer 1 (Top View)

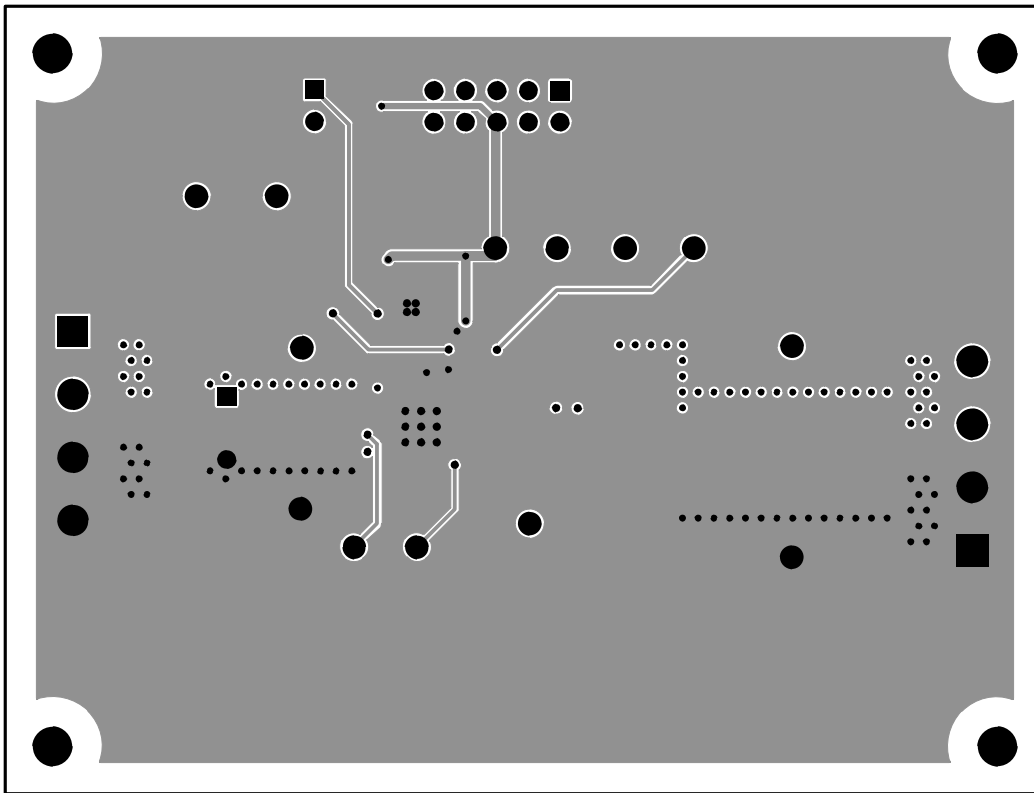

Figure 8-5. TPS53819AEVM-123 Internal Layer 3 (Top View)

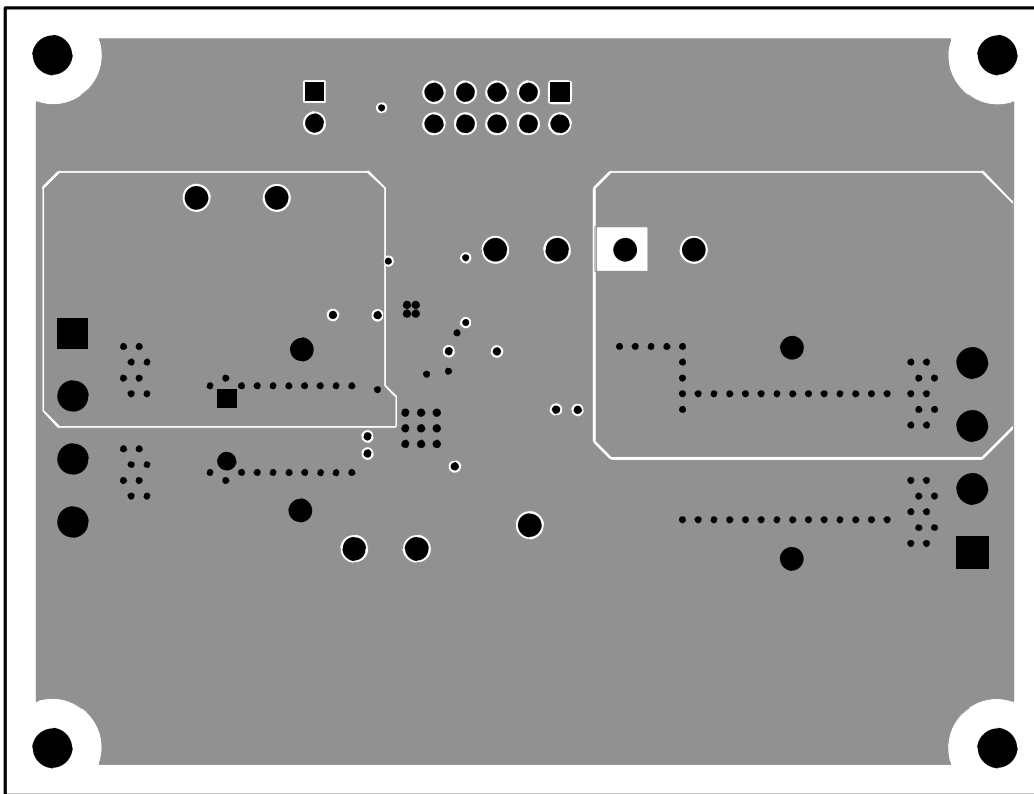

Figure 8-6. TPS53819AEVM-123 Internal Layer 4 (Top View)

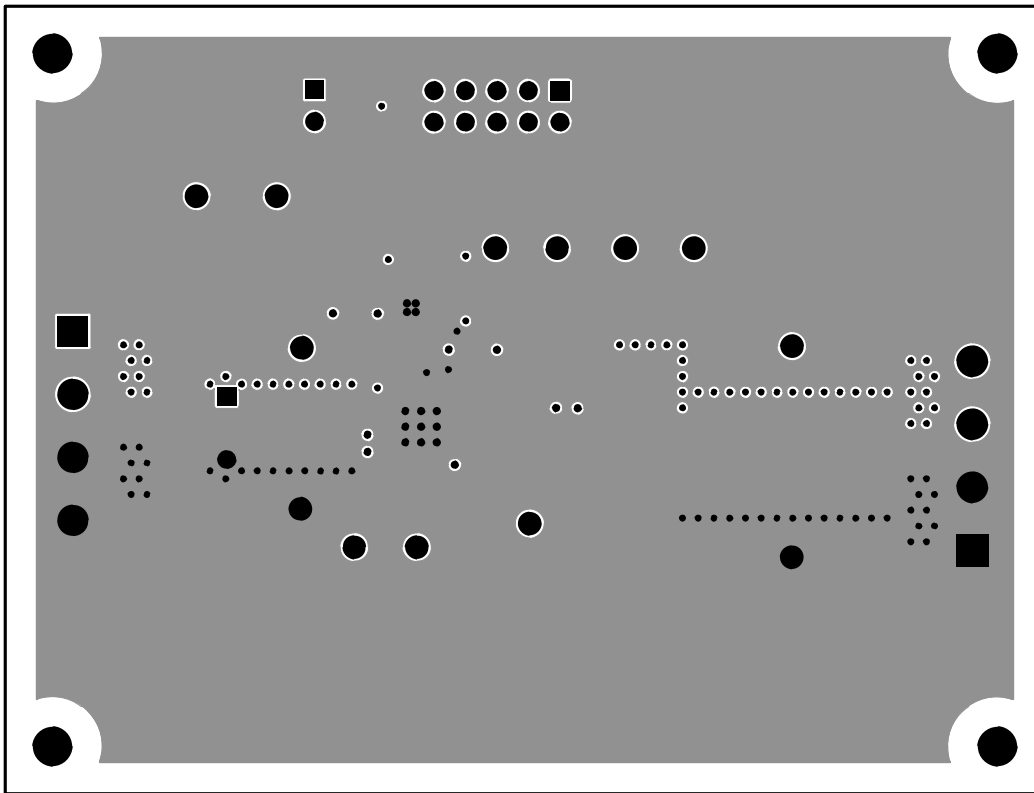

Figure 8-7. TPS53819AEVM-123 Internal Layer 5 (Top View)

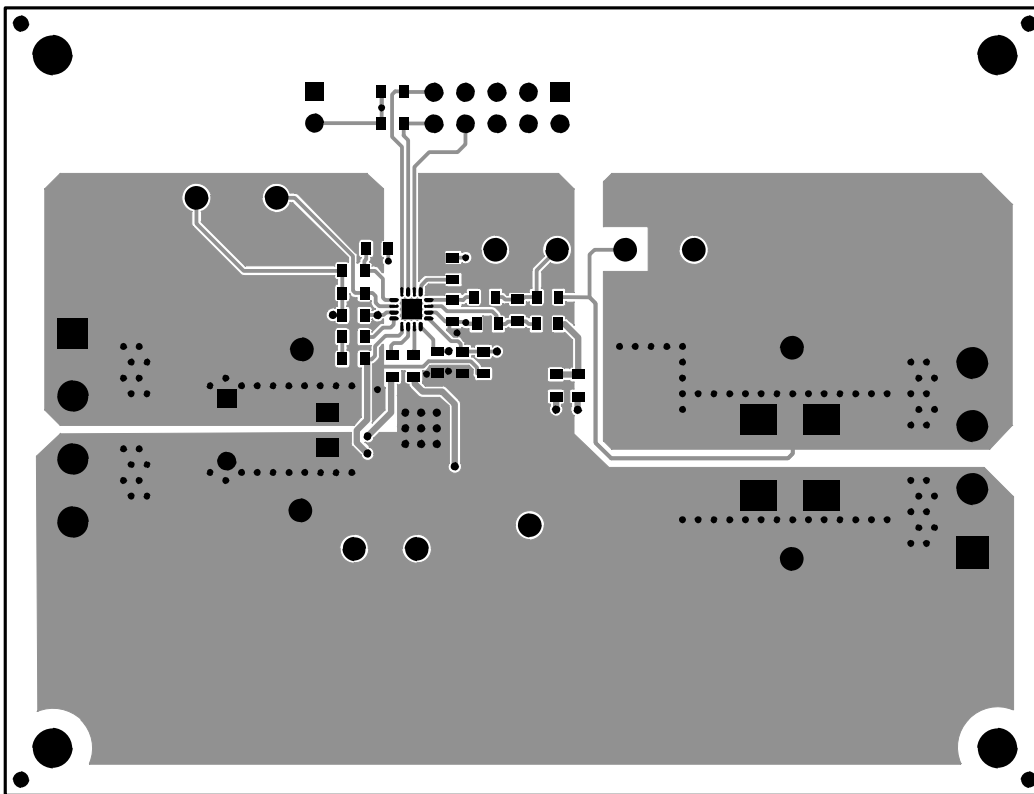

Figure 8-8. TPS53819AEVM-123 Bottom Copper (Top View)

9 Bill of Materials

Table 9-1. TPS53819AEVM-123 List of Materials

COUNT	REFDES	DESCRIPTION	PART NUMBER	MFR
4	C1–C4	Capacitor, Ceramic, 22 μ F, 16 V, X5R, 10%	GRM31CR61C226ME15L	Murata
2	C5, C7	Capacitor, Ceramic, 0.1 μ F, 50 V, X7R, 10%	Std	Std
0	C6	Capacitor, OSCON, 330 μ F, 16 V	16SEP330M	Sanyo
1	C8	Capacitor, Ceramic, 1000 pF, 50 V, X7R, 20%	Std	Std
0	C9, C17	Capacitor, Ceramic, 50 V, X7R, 10%	Std	Std
5	C10–C14	Capacitor, Ceramic, 100 μ F, 6.3 V, X5R, 20%	GRM32ER60J107ME20L	Murata
0	C15–C16	Capacitor, POSCAP, SMT, 2.5 V, 330 μ F, 8 m Ω	2R5TPE330M9 or 6TPE330MIL	Sanyo
2	C18, C19	Capacitor, Ceramic, 1 μ F, 16 V, X7R, 10%	Std	Std
2	J1, J3	Terminal Block, 4-pin, 15-A, 5.1 mm	ED120/4DS	OST
1	J2	Header, Male 2-pin, 100-mil spacing	PEC02SAAN	Sullins
1	J4	Connector, Male Straight 2 \times 5 pin, 100-mil spacing, 4 Wall	N2510-6002RB	3M
1	L1	Inductor, Toroid, 0.440 μ H, 30 A, 0.0032 Ω	PA0513.441NLT or 744309047	Pulse or WE
1	Q1	MOSFET, Dual N-Chan, 30 V 27 A	CSD87350Q5D	TI
4	R1–R2, R14–R15	Resistor, Chip, 100 k Ω , 1/16W, 1%	Std	Std
1	R3	Resistor, Chip, 300 k Ω , 1/16W, 1%	Std	Std
1	R4	Resistor, Chip, 1.00 k Ω , 1/16W, 1%	Std	Std
2	R6	Resistor, Chip, 4.7 Ω , 1/16W, 1%	Std	Std
1	R9	Resistor, Chip, 3 Ω , 1/4W, 1%	Std	Std
0	R7, R13	Resistor, Chip, 1/16W, 1%	Std	Std
1	R10	Resistor, Chip, 39.2 k Ω , 1/16W, 1%	Std	Std
5	R5, R8, R11–R12, R16	Resistor, Chip, 0 Ω , 1/10W, 1%	Std	Std
2	R17–R18	Resistor, Chip, 10.0 k Ω , 1/16W, 1%	Std	Std
10	TP1–TP3, TP5–TP8, TP10–TP11, TP13	Test Point, Red, Thru Hole Color Keyed	5000	Keystone
3	TP4, TP9, TP12	Test Point, Black, Thru Hole Color Keyed	5001	Keystone
1	U1	IC, Single Synchronous Step-Down Controller with PMBus	TPS53819ARGT	TI
1	—	Shunt, 100-mil, Black	929950-00	3M
1	—	PCB, 2.5 inch \times 3.3 inch \times 0.062 inch	PWR123	Any
4	—	STANDOFF HEX .375"L 4-40THR NYL	1902B	Keystone
4	—	STANDOFF M/F HEX 4-40 NYL 1.00"L	4806	Keystone

10 Revision History

NOTE: Page numbers for previous revisions may differ from page numbers in the current version.

Changes from Revision A (December 2012) to Revision B (November 2021)	Page
• Updated the numbering format for tables, figures, and cross-references throughout the document.	2
• Updated the user's guide title.....	2

IMPORTANT NOTICE AND DISCLAIMER

TI PROVIDES TECHNICAL AND RELIABILITY DATA (INCLUDING DATA SHEETS), DESIGN RESOURCES (INCLUDING REFERENCE DESIGNS), APPLICATION OR OTHER DESIGN ADVICE, WEB TOOLS, SAFETY INFORMATION, AND OTHER RESOURCES "AS IS" AND WITH ALL FAULTS, AND DISCLAIMS ALL WARRANTIES, EXPRESS AND IMPLIED, INCLUDING WITHOUT LIMITATION ANY IMPLIED WARRANTIES OF MERCHANTABILITY, FITNESS FOR A PARTICULAR PURPOSE OR NON-INFRINGEMENT OF THIRD PARTY INTELLECTUAL PROPERTY RIGHTS.

These resources are intended for skilled developers designing with TI products. You are solely responsible for (1) selecting the appropriate TI products for your application, (2) designing, validating and testing your application, and (3) ensuring your application meets applicable standards, and any other safety, security, regulatory or other requirements.

These resources are subject to change without notice. TI grants you permission to use these resources only for development of an application that uses the TI products described in the resource. Other reproduction and display of these resources is prohibited. No license is granted to any other TI intellectual property right or to any third party intellectual property right. TI disclaims responsibility for, and you will fully indemnify TI and its representatives against, any claims, damages, costs, losses, and liabilities arising out of your use of these resources.

TI's products are provided subject to [TI's Terms of Sale](#) or other applicable terms available either on ti.com or provided in conjunction with such TI products. TI's provision of these resources does not expand or otherwise alter TI's applicable warranties or warranty disclaimers for TI products.

TI objects to and rejects any additional or different terms you may have proposed.

Mailing Address: Texas Instruments, Post Office Box 655303, Dallas, Texas 75265
Copyright © 2022, Texas Instruments Incorporated