

bq24072/3/4/5/9(T) and bq24230/2 1.5-A Single-Chip Li-Ion and Li-Polymer Charge Management IC EVM

This user's guide describes the bq24072/3/4/5/9(T) and bq24230/2 (bqTINY-III™) evaluation module (EVM). The EVM provides a convenient method for evaluating the performance of a charge management and system power solution for portable applications using the bq24072/3/4/5/9(T) and bq24230/2 product families. A completely designed and tested module is presented. The charger is designed to deliver up to 1.5 A of continuous current to the system or charger for one-cell Li-ion or Li-polymer applications (see the data sheet for correct device) using a dc power supply. The charger is programmed from the factory to deliver 0.9 A of charging current. This EVM was designed as a stand-alone evaluation module, but it also can be interfaced with the system and host via the connectors and headers.

Contents

1	Introduction	2
2	Considerations When Testing and Using bq24072/3/4/5/9(T) and bq24230/2 ICs	2
3	Performance Specification Summary	3
4	Test Summary	4
5	Schematic.....	8
6	Physical Layouts	9
7	Bill of Materials	12
8	References	15

List of Figures

1	Test Diagram	5
2	Modes of Operation Tested in Steps 11 Through 13	6
3	Charger Profile With EN1 = VSS and EN2 = HI, Programmed by ISET	7
4	Charge Enabled, Pulled High, Then Low – Disables Charge.....	7
5	Schematic.....	8
6	Top Assembly View	9
7	Board Layout – Top Etch Layer	10
8	Board Layout – Bottom Etch Layer	11

List of Tables

1	Ordering Information	2
2	Performance Specification Summary for bq24072/3/4/5/9(T) and bq24230/2 EVMs.....	3
3	bq240xx	4
4	HPA282B Bill of Materials	12
5	HPA282B Bill of Materials (Continued).....	13
6	HPS252B Bill of Materials.....	14
7	HPA502A Bill of Materials.....	15

Trademarks

bqTINY-III is a trademark of Texas Instruments.

1 Introduction

The bq2407x and bq2432x powers the system while independently charging the battery. This feature reduces the charge and discharge cycles on the battery, allows for proper charge termination, and allows the system to run with an absent or defective battery pack. This feature also allows for the system to instantaneously turn on from an external power source even when using a deeply discharged battery pack.

This charger has one input and can be programmed to be used with an adapter or USB port as the power source for the system. In the USB configuration, the host can select from the two preset input maximum rates of 100 mA and 500 mA. The charger dynamically adjusts the charge rate based on the system load to stay within the 100-mA or 500-mA maximum limits. An external resistor, RSET1, sets the magnitude of the charge current. If the charge current exceeds the available input current, the voltage on the OUT pin drops to the DPPM threshold or the battery voltage, whichever is higher. The charging current is reduced to what current is available ($I_{BAT} = I_{IN} - I_{OUT}$).

The integrated circuit (IC) charges the battery in three phases: conditioning, constant current, and constant voltage. Charge is terminated based on minimum current. A resistor-programmable charge timer provides a backup safety for charge termination. The charge automatically re-starts if the battery voltage falls below an internal threshold. Sleep mode is entered when the supply is removed (V_{IN} drops to the battery voltage).

2 Considerations When Testing and Using bq24072/3/4/5/9(T) and bq24230/2 ICs

Consider the following noteworthy items while testing and using the bq2403x ICs.

The bq24072/3/4/5/9(T) series targets current above a nominal 500 mA (>350 mA) and the difference are listed in [Table 1](#).

Table 1. Ordering Information

Part Number	V_{OVP}	V_{BAT}	$V_{OUT(REG)}$	V_{DPM}	Optional Function	Marking
bq24072RGTR	6.6 V	4.2 V	$V_{BAT} + 200$ mV	$V_{O(REG)} - 100$ mV	TD	CKP
bq24072RGTT	6.6 V	4.2 V	$V_{BAT} + 200$ mV	$V_{O(REG)} - 100$ mV	TD	CKP
bq24072TRGTR	6.6 V	4.2 V	$V_{BAT} + 225$ mV	$V_{O(REG)} - 100$ mV	TD	PAP
bq24072TRGTT	6.6 V	4.2 V	$V_{BAT} + 225$ mV	$V_{O(REG)} - 100$ mV	TD	PAP
bq24073RGTR	6.6 V	4.2 V	4.4 V	$V_{O(REG)} - 100$ mV	TD	CKQ
bq24073RGTT	6.6 V	4.2 V	4.4 V	$V_{O(REG)} - 100$ mV	TD	CKQ
bq24074RGTR	10.5 V	4.2 V	4.4 V	$V_{O(REG)} - 100$ mV	ITERM	BZF
bq24074RGTT	10.5 V	4.2 V	4.4 V	$V_{O(REG)} - 100$ mV	ITERM	BZF
bq24075RGTR	6.6 V	4.2 V	5.5 V	4.3 V	SYSOFF	CDU
bq24075RGTT	6.6 V	4.2 V	5.5 V	4.3 V	SYSOFF	CDU
bq24075TRGTR	6.6 V	4.2 V	5.5 V	4.3 V	SYSOFF	OEC
bq24075TRGTT	6.6 V	4.1 V	5.5 V	4.3 V	SYSOFF	OEC
bq24079RGTR	6.6 V	4.1 V	5.5 V	4.3 V	SYSOFF	ODI
bq24079RGTT	6.6 V	4.1 V	5.5 V	4.3 V	SYSOFF	ODI
bq24079TRGTR	6.6 V	4.1 V	5.5 V	4.3 V	SYSOFF	OED
bq24079TRGTT	6.6 V	4.1 V	5.5 V	4.3 V	SYSOFF	OED

The bq24079(T) ICs are regulated to 4.1 V. The "T" version uses a voltage-based TS bias, which allows more flexibility in setting the temperature range, whereas the bq24072/3/4/5 ICs use current-biased TS.

The bq24230/2 family is identical to the bq24073/4 ICs except that they are trimmed and their target current values nominally are at 300 mA (<450 mA). This family is suited for headset designs. The pinout of each IC is the same across both families except pin 15 (JMP2 on the EVM); the pin 15 function is listed in [Table 1](#) under the *Optional Function* column.

The two potential sources to power the system (V_{OUT}) are the input source and the battery (adapter or USB port). The IC is designed to power the system continuously. The battery, in most cases, is the last line of backup. If the adapter/USB input is not available (or disabled), the battery connects to the system.

In thermal regulation condition ($T_J = 125^\circ\text{C}$ not a first-choice design mode of operation), the charge current is reduced to the battery, and the system still gets its power from the input. The battery supplement is available in thermal regulation if the V_{OUT} falls to V_{BAT} . In thermal cutoff ($\sim 155^\circ\text{C}$), the input sources are disconnected, but the internal battery FET connects the battery to V_{OUT} .

3 Performance Specification Summary

Table 2 summarizes the performance specifications of the EVM.

Table 2. Performance Specification Summary for bq24072/3/4/5/9(T) and bq24230/2 EVMs

SPECIFICATION	TEST CONDITIONS	MIN	TYP	MAX	UNITS
Input dc Voltage, $V_{I(AC)}$		4.75	5	6.5	Volts
Battery Charge Current, $I_{O(CHG)}$			1	1.5	Amperes
Power Dissipation, bq24072/3/4/5/9(T) and bq24230/2 IC, 1 Cell	$P_{diss} = (V_{in}-V_{out})I_{out} + (V_{in}-V_{bat})I_{bat}$			See ⁽¹⁾	Watts

⁽¹⁾ The HPA073 (bq24072/3/4/5/9(T) and bq24230/2) thermal design is optimized (8+ vias, 0.031-inch PCB, 2-oz. copper) to give $\theta_{JA} \sim 27^\circ\text{C/W}$.

3.1 Performance Recommendations

This IC is a linear battery charger and also powers the system from the input via the linear regulator output. The key here is that this is a linear device that is most efficient when the input voltage is not too far above the battery voltage ($V_{in} = 4.75\text{ V to }5.5\text{ V}$). Too low of input voltage (less than the OUT voltage plus the dropout voltage) results in degraded performance. Excessive input voltage ($>5.5\text{ V}$) results in excess power dissipation and reduced performance via thermal regulation. The IC is rated to 28 V, and will not be damaged with V_{in} voltages less than this, but any V_{in} voltage over the overvoltage protection (OVP) threshold disables the IC. Thus, the recommended operating range for maximum performance is between 4.75 V and 5.5 V, with a preference toward the lower values.

4 Test Summary

This section covers the setup and tests performed in evaluating the EVM.

4.1 Equipment

- Power supply (+5.25 \pm 0.25 Vdc), current limit set to 2 A \pm 0.2 A
- Three Fluke 75 DMMs (equivalent or better)
- Oscilloscope, Model TDS220 (equivalent or better)

4.2 Equipment and EVM Setup

- Preset P/S#1 to 5.25 V \pm 0.25 V, 2 A \pm 0.25-A current limit, turn off and connect to J1-IN/GND (+ to IN and – to GND)
- Connect a 10- Ω , 10-W resistor to J2-OUT/VSS
- Connect a fully discharged (Vbat <2.8 V) Battery to J3-BAT+/VSS (+ to BAT+ and – to VSS).
- Apply the jumpers as per [Table 3](#).
- For the bq2407xEVM, adjust the potentiometers as follows (measure resistance from TP# to VSS):
 - R8 (ILIM-TP12) = 750 Ω (743 to 757); R11 (ISET-TP16) = 1 k Ω (0.98 k Ω to 1.02 k Ω) and R16 (TS-TP1) = 7.5 k Ω (7.3 k Ω to 7.7 k Ω); and for '74 (-003): R10 (ITERM-TP15) = 3 k Ω (2.98 k Ω to 3.02 k Ω).
- For the bq2423xEVM, adjust the potentiometers as follows (measure resistance from TP# to VSS):
 - R8 (ILIM-TP12) = 750 Ω (743 to 757); R11 (ISET-TP16) = 2.96 k Ω (2.93 k Ω to 2.99 k Ω) and R16 (TS-TP1) = 7.5 k Ω (7.3 k Ω to 7.7 k Ω); and for '74 (-006): R10 (ITERM-TP15) = 3 k Ω (2.98 k Ω to 3.02 k Ω).

Table 3. bq240xx

Jumper	'72	'73 or '230	'74 or '232	'75
JMP1	RES-TMR	RES-TMR	RES-TMR	RES-TMR
JMP2	TD-Vss	TD-Vss	TD-Vss	TD-Vss
JMP3	CE-Vss	CE-Vss	CE-Vss	CE-Vss
JMP4	EN2-HI	EN2-HI	EN2-HI	EN2-HI
JMP5	EN1-Vss	EN1-Vss	EN1-Vss	EN1-Vss

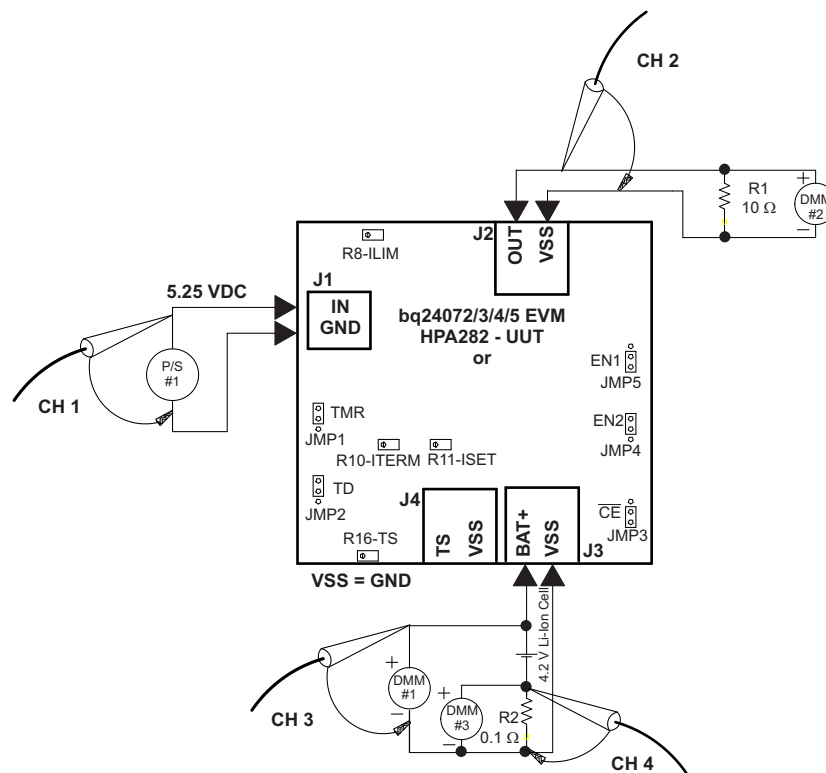

Figure 1. Test Diagram

4.3 Test Procedure

1. Verify that the equipment and EVM is set up according to the preceding section.
2. Verify that V_{OUT} is approximately equal to V_{BAT}
3. Turn on P/S#1, +5.25-Vdc supply to the UUT.
4. Verify V_{BAT} is between 2.4 Vdc and 3 Vdc, and the charger is in precharge state: LEDs CHG (D1) and PGOOD (D2) are on. If V_{BAT} is above the low-voltage threshold ($V_{(LOWV)} \sim 3$ V), then the IC is in fast-charge mode. If the IC is in fast charge, skip step 7.
5. Verify DMM#3, I_{BAT} is ~ 9 mV or ~ 0.09 A
6. Verify that V_{OUT} for bq24072 is ~ 200 mV above the battery voltage or a minimum of 3.4 Vdc. For bq24073/4 verify that V_{OUT} is ~ 4.4 Vdc. Verify that bq24075/9(T) is ~ 5.5 Vdc for $V_{IN} > 5.6$ V and equal to V_{IN} for $V_{IN} < 5.6$ V.
7. Allow the battery to charge until V_{BAT} is between 3.3 Vdc and 4 Vdc. The charger delivers the programmed constant current to the battery unless the input cannot source the required current.
8. Verify I_{BAT} is ~ 88 mV or ~ 0.9 A (for a 1-k Ω resistor on *ISET*).
9. Verify V_{OUT} : bq24072 – ~ 200 mV above the battery voltage.
10. Set JMP5 (EN1) to HI, and verify that the chip has been disabled, D1 (CHG) has turned off, and the P/S#1 current has dropped to zero. The internal battery FET must be on, connecting the BAT pin to the OUT pin. Verify that the voltage on the OUT pin is close to the battery voltage. See Figure 2 for EN1/2 modes of operation.
11. SET JMP4 (EN2) to VSS. Verify that the input current is less than 500 mA (USB 500-mA mode). If the input current is restricted due to USB mode, or if the adapter is current limiting, the OUT pin drops in voltage and enters the DPM mode, if the system current is less than the restricted input current. This IC must be in DPM mode with the system voltage at the DPM
12. Set JMP5 (EN1) to VSS and verify USB 100-mA mode. The system load is more than the allowed 100 mA on the input, so the OUT voltage drops to the battery voltage, and the battery FET is switched on

- and supplements the input current. Verify that V_{out} has dropped just below the battery voltage and the battery is supplying I_{bat} , $\sim(V_{out}/10\ \Omega - 100\ \text{mA})$.
13. Set JMP4 (EN2) to HI to return to the ISET mode where the programmed current is $\sim 0.9\ \text{A}$.
 14. Set JMP3 to HI, and verify that the charging is disabled and that the CHG LED (D1) turns off. Verify that the system is still powered by the input. See [Figure 3](#).
 15. Set JMP3 to VSS, and verify that charging continues and that D1 turn on.
 16. Record the OUT voltage and battery charge current. Adjust R8 CCW until the input current starts to be reduced (~ 2 turns). Note how the OUT voltage drops and the charge current is reduced as the input current limit loops kicks in and limits the input current. Adjust R8 to its original position
 17. On the bq24075 IC, set JMP2 HI, and verify that the BAT FET turns off and allows no charging or discharging of the battery.
 18. Adjust the R16 (TS-Pot) up or down until the TS threshold is reached. Verify that the charging current is disabled. Return the TS resistance within the normal range and verify the continued charging operation.
 19. Allow the battery to continue to charge until the battery reaches voltage regulation, $\sim 4.2\ \text{V} \pm 40\ \text{mV}$ for bq24072/3/4/5/9(T) and $4.1\ \text{V} \pm 4\ \text{mV}$ for bq24079(T). Verify that the voltage is regulated as the current tapers over the next one-to-two hours depending on the battery capacity. See [Figure 4](#) for a charge profile (time in plot is not proportional to actual charge time).
 20. Verify that the current tapers to around $90\ \text{mA}$ ($9\ \text{mV}$ on DMM#3) when termination occurs. Note on the '72 and '73 ICs that termination can be disabled by setting the TD pin HI (JMP2). Also note that on '74, the ITERM resistor (R10) can adjust the termination threshold.
 21. Verify that the LED, D1, turns off and the current drops to zero.
 22. Turn off P/S#1, and allow the system load to discharge the battery until a refresh charge is initiated. Verify that the battery voltage dropped to $\sim 4.1\ \text{V}$ for bq24072/3/4/5 and to $4.0\ \text{V}$ for bq24079(T) prior to refresh.
 23. Verify that the LED, D1, did not turn on for the refresh cycle.

This concludes the procedure for demonstrating the features of this power path charger. See the data sheet for more detailed explanations and instructive waveforms.

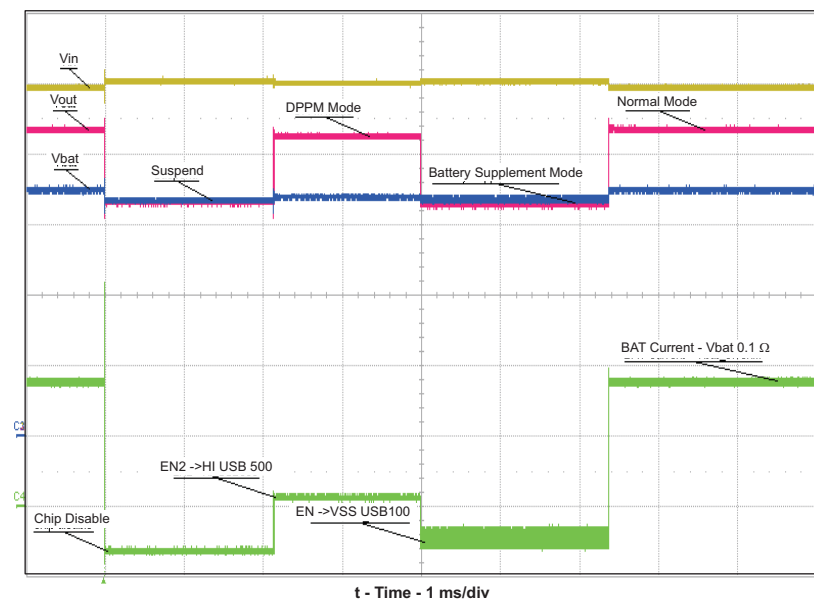

Figure 2. Modes of Operation Tested in Steps 11 Through 13

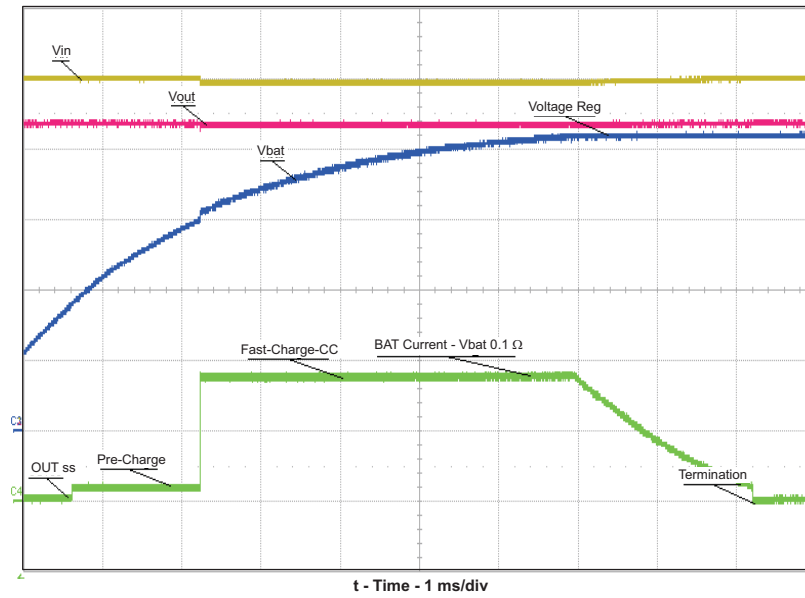

Figure 3. Charger Profile With EN1 = VSS and EN2 = HI, Programmed by ISET

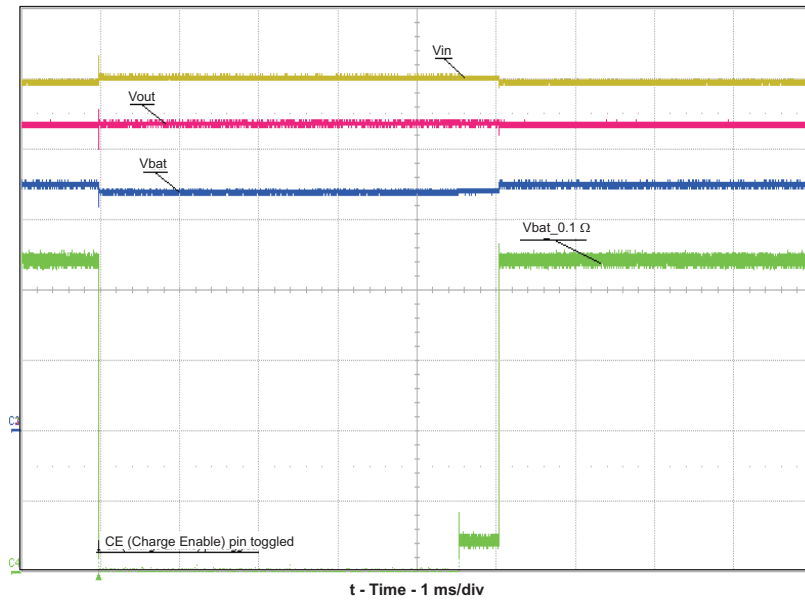
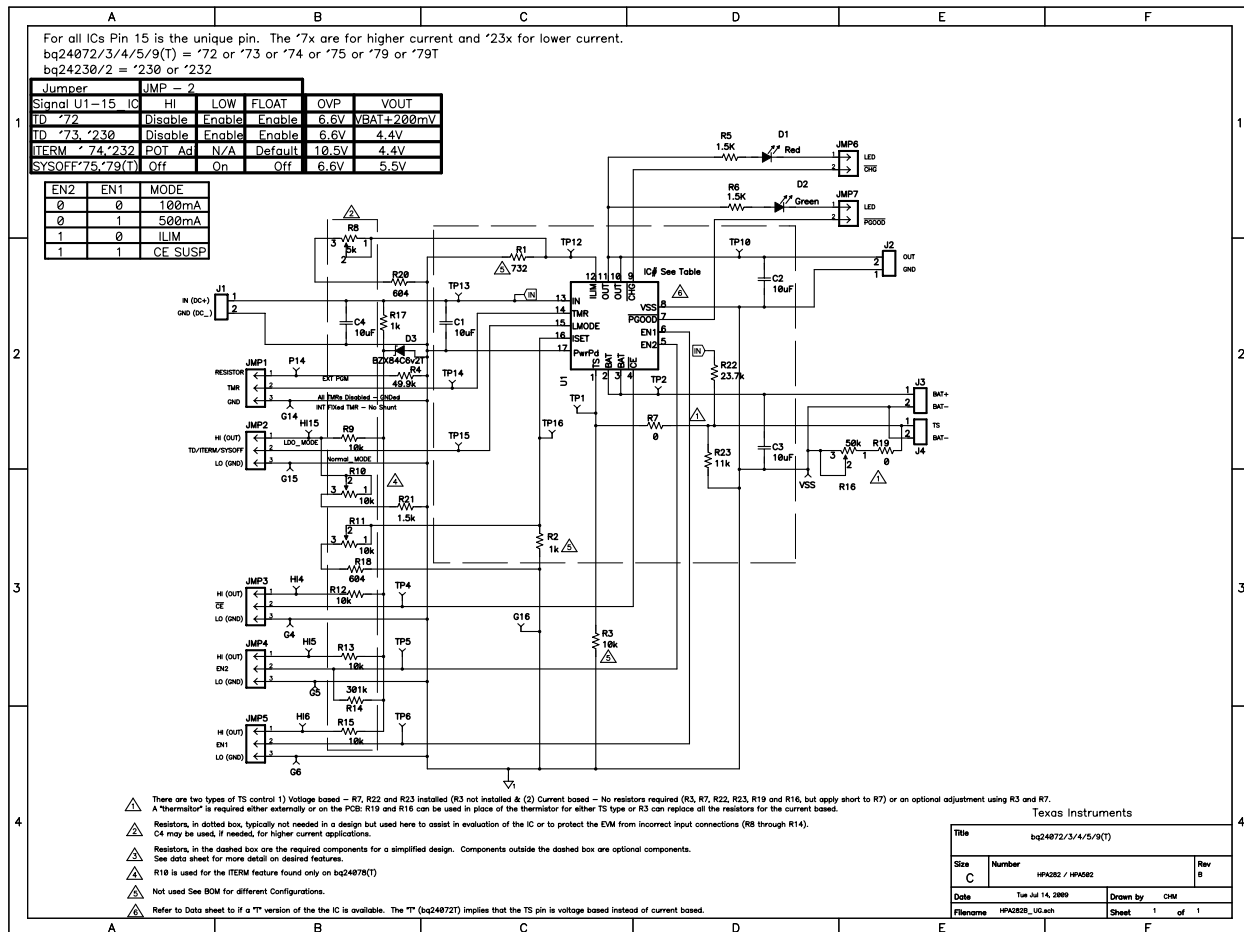

Figure 4. Charge Enabled, Pulled High, Then Low – Disables Charge

5 Schematic

The bq24072/3/4/5/9(T) and bq24230/2 EVM schematic is shown in Figure 5



Copyright © 2016, Texas Instruments Incorporated

Figure 5. Schematic

6 Physical Layouts

This section contains the board layout and assembly drawings for the EVM.

6.1 Board Layout

Figure 6 shows the top assembly view of the EVM. Figure 7 shows the top etch layer of the EVM and Figure 8 shows the bottom etch layer.

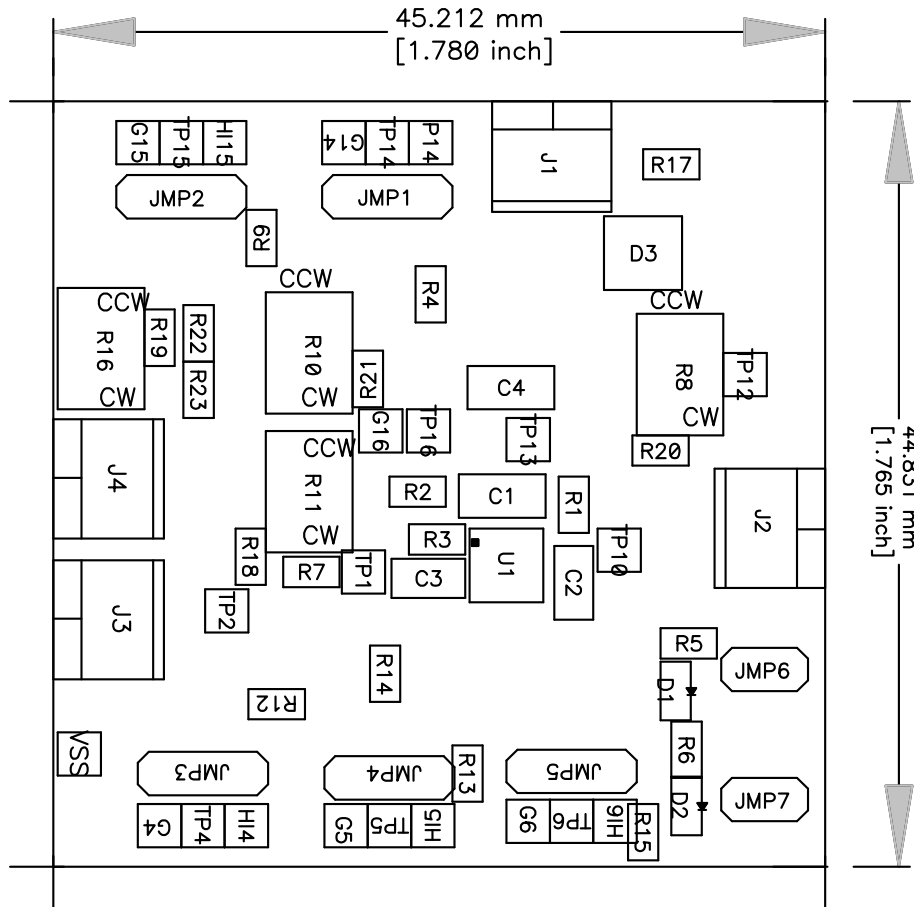

Figure 6. Top Assembly View

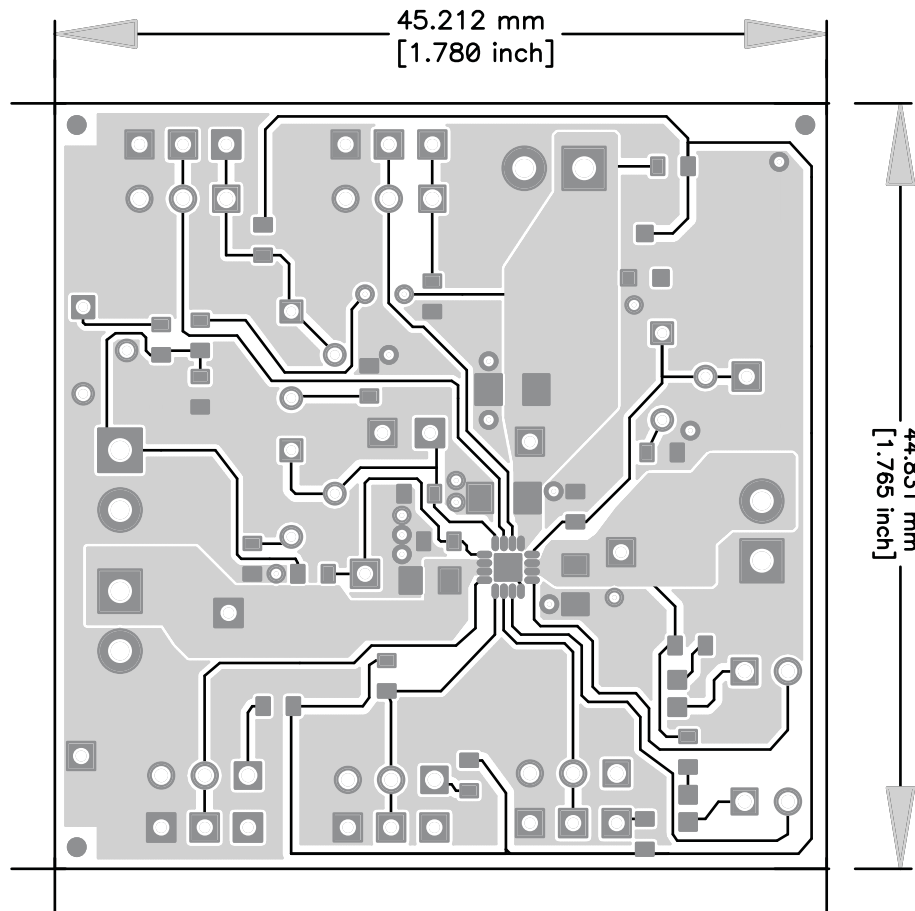

Figure 7. Board Layout – Top Etch Layer

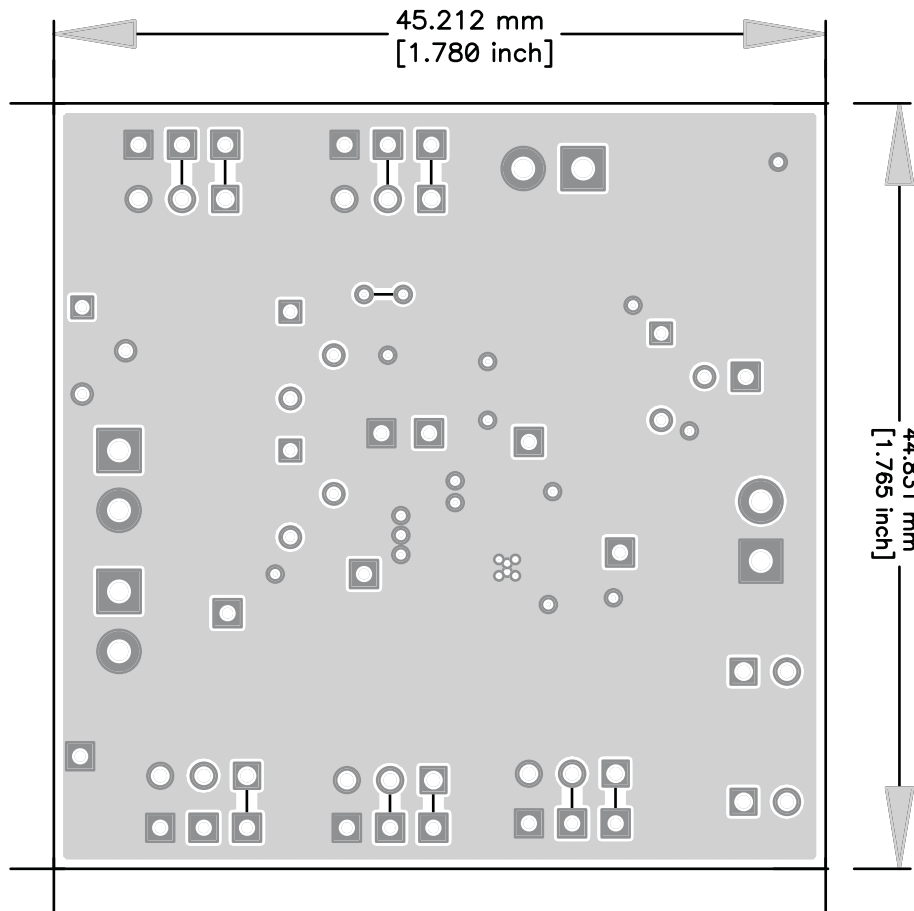

Figure 8. Board Layout – Bottom Etch Layer

7 Bill of Materials

Table 4. HPA282B Bill of Materials

-001	-002	-003	-004	RefDes	Value	Description	SIZE	Part Number	MFR
2	2	2	2	C1, C4	10uF	Capacitor, Ceramic, 10-uF, 25-V, X5R, 20%	1206	ECJ-3YB1E106M	Panasonic
2	2	2	2	C2, C3	10uF	Capacitor, Ceramic, 10-uF, 6.3-V, X5R, 20%	0805	ECJ-2FBOJ106M	Panasonic
1	1	1	1	D1	Red	Diode, LED, Red, 1.8-V, 20-mA, 20-mcd	0603	LTST-C190CKT	Liteon
1	1	1	1	D2	Green	Diode, LED, Green, 2.1-V, 20-mA, 6-mcd	0603	LTST-C190GKT	Liteon
1	1	1	1	D3	BZX84C6v2T	Diode, Zener, 6.2-V, 350-mW	SOT-23	BZX84C6V2T	Diodes
2	2	2	2	J1, J2, J3, J4*	ED1514	Terminal Block, 2-pin, 6-A, 3.5mm	0.27 x 0.25	ED1514	OST
5	5	5	5	JMP1–JMP5	PEC02SAAN	Header, 3-pin, 100mil spacing	0.100 x 3	PEC02SAAN	Sullins
2	2	2	2	JMP6, JMP7	PEC03SAAN	Header, 2-pin, 100mil spacing	0.100 inch x 2	PEC03SAAN	Sullins
0	0	0	0	R1	732	Resistor, Chip, 1/16W, 1%	0603	Std	Std
0	0	1	0	R10	10k	Potentiometer, 1/4 in. Cermet, 12-Turn, Top-Adjust	0.25x0.17	3266W-103LF	Bourns
1	1	1	1	R11	10k	Potentiometer, 1/4 in. Cermet, 12-Turn, Top-Adjust	0.25x0.17	3266W-103LF	Bourns
1	1	1	1	R14	301k	Resistor, Chip, 1/16W, 1%	0603	Std	Std
1	1	1	1	R16	50k	Potentiometer, 1/4 in. Cermet, 12-Turn, Top-Adjust	0.25x0.17	3266W-503LF	Bourns
1	1	1	1	R17	1k	Resistor, Chip, 1/16W, 1%	0603	Std	Std
2	2	2	2	R18, R20	604	Resistor, Chip, 1/16W, 1%	0603	Std	Std
0	0	0	0	R2	1k	Resistor, Chip, 1/16W, 1%	0603	Std	Std
0	0	0	0	R3	10k	Resistor, Chip, 1/16W, 1%	0603	Std	Std
1	1	1	1	R4	49.9k	Resistor, Chip, 1/16W, 1%	0603	Std	Std
2	2	2	2	R5, R6	1.5K	Resistor, Chip, 1/16W, 1%	0603	Std	Std
0	0	1	0	R21	1.5K	Resistor, Chip, 1/16W, 1%	0603	Std	Std
0	0	0	0	R22	23.7K	Resistor, Chip, 1/16W, 1%	0603	Std	Std
0	0	0	0	R23	11K	Resistor, Chip, 1/16W, 1%	0603	Std	Std
1	1	1	1	R7, R19	0	Resistor, Chip, 1/16W, 1%	0603	Std	Std
1	1	1	1	R8	5k	Potentiometer, 1/4 in. Cermet, 12-Turn, Top-Adjust	0.25x0.17	3266W-502LF	Bourns
1	1	0	1	R9	10k	Resistor, Chip, 1/16W, 1%	0603	Std	Std
3	3	3	3	R12, R13, R15	10k	Resistor, Chip, 1/16W, 1%	0603	Std	Std
1	0	0	0	U1	BQ24072RGT	IC, USB- Friendly Li-Ion Battery Charger and Power-Path Management	QFN-16	BQ24072RGT	TI
0	1	0	0	U1	BQ24073RGT		QFN-16	BQ24073RGT	TI
0	0	1	0	U1	BQ24074RGT		QFN-16	BQ24074RGT	TI
0	0	0	1	U1	BQ24075RGT		QFN-16	BQ24075RGT	TI
1	1	1	1	--		PCB, 1.8 In x 1.7 In x 0.031 In		HPA282	Any
7	7	7	7		929950-00	Shunts	100 mill	Black	3M

- Notes: 1. These assemblies are ESD sensitive, ESD precautions shall be observed.
2. These assemblies must be clean and free from flux and all contaminants. Use of no clean flux is not acceptable.
3. These assemblies must comply with workmanship standards IPC-A-610 Class 2.
4. Ref designators marked with an asterisk (***) cannot be substituted. All other components can be substituted with equivalent MFG's components.
5. * No substitutions of J1 through J4
6. Place Shunt as follows: JMP1=TRM:RES, JMP3=CE:VSS, JMP4=EN2:HI, JMP5, EN1:VSS, JMP6=pin1:pin2, JMP7=pin1:pin2
For JMP2=001/002/003=TD:HI, -004=TD:VSS:VSS,

Table 5. HPA282B Bill of Materials (Continued)

-005	-006	RefDes	Value	Description	SIZE	Part Number	MFR
2	2	C1, C4	10uF	Capacitor, Ceramic, 10-uF, 25-V, X5R, 20%	1206	ECJ-3YB1E106M	Panasonic
2	2	C2, C3	10uF	Capacitor, Ceramic, 10-uF, 6.3-V, X5R, 20%	0805	ECJ-2FB0J106M	Panasonic
1	1	D1	Red	Diode, LED, Red, 1.8-V, 20-mA, 20-mcd	0603	LTST-C190CKT	Liteon
1	1	D2	Green	Diode, LED, Green, 2.1-V, 20-mA, 6-mcd	0603	LTST-C190GKT	Liteon
1	1	D3	BZX84C6V2T	Diode, Zener, 6.2-V, 350-mW	SOT-23	BZX84C6V2T	Diodes
2	2	J1, J2, J3, J4*	ED1514	Terminal Block, 2-pin, 6-A, 3.5mm	0.27 x 0.25	ED1514	OST
5	5	JMP1– JMP5	PEC02SAAN	Header, 3-pin, 100mil spacing	0.100 x 3	PEC02SAAN	Sullins
2	2	JMP6, JMP7	PEC03SAAN	Header, 2-pin, 100mil spacing	0.100 inch x 2	PEC03SAAN	Sullins
0	0	R1	732	Resistor, Chip, 1/16W, 1%	0603	Std	Std
0	1	R10	10k	Potentiometer, 1/4 in. Cermet, 12-Turn, Top-Adjust	0.25x0.17	3266W-103LF	Bourns
1	1	R11	10k	Potentiometer, 1/4 in. Cermet, 12-Turn, Top-Adjust	0.25x0.17	3266W-103LF	Bourns
1	1	R14	301k	Resistor, Chip, 1/16W, 1%	0603	Std	Std
1	1	R16	50k	Potentiometer, 1/4 in. Cermet, 12-Turn, Top-Adjust	0.25x0.17	3266W-503LF	Bourns
1	1	R17	1k	Resistor, Chip, 1/16W, 1%	0603	Std	Std
2	2	R18, R20	604	Resistor, Chip, 1/16W, 1%	0603	Std	Std
0	0	R2	1k	Resistor, Chip, 1/16W, 1%	0603	Std	Std
0	0	R3	10k	Resistor, Chip, 1/16W, 1%	0603	Std	Std
1	1	R4	49.9k	Resistor, Chip, 1/16W, 1%	0603	Std	Std
2	2	R5, R6	1.5K	Resistor, Chip, 1/16W, 1%	0603	Std	Std
0	1	R21	1.5K	Resistor, Chip, 1/16W, 1%	0603	Std	Std
0	0	R22	23.7K	Resistor, Chip, 1/16W, 1%	0603	Std	Std
0	0	R23	11K	Resistor, Chip, 1/16W, 1%	0603	Std	Std
1	1	R7, R19	0	Resistor, Chip, 1/16W, 1%	0603	Std	Std
1	1	R8	5k	Potentiometer, 1/4 in. Cermet, 12-Turn, Top-Adjust	0.25x0.17	3266W-502LF	Bourns
1	0	R9	10k	Resistor, Chip, 1/16W, 1%	0603	Std	Std
3	3	R12, R13, R15	10k	Resistor, Chip, 1/16W, 1%	0603	Std	Std
1	0	U1	BQ24230RGT	IC, USB- Friendly Lilon Battery Charger and Power-Path Management	QFN-16	BQ24230RGT	TI
0	1	U1	BQ24232RGT		QFN-16	BQ24232RGT	TI
1	1	--		PCB, 1.8 In x 1.7 In x 0.031 In		HPA282	Any
7	7		929950-00	Shunts	100 mill	Black	3M

- Notes: 1. These assemblies are ESD sensitive, ESD precautions shall be observed.
2. These assemblies must be clean and free from flux and all contaminants. Use of no clean flux is not acceptable.
3. These assemblies must comply with workmanship standards IPC-A-610 Class 2.
4. Ref designators marked with an asterisk (***) cannot be substituted.
All other components can be substituted with equivalent MFG's components.
5. * No substitutions of J1 through J4
6. Place Shunt as follows: JMP1=TRM:RES, JMP3=CE:VSS, JMP4=EN2:HI, JMP5, EN1:VSS, JMP6=pin1:pin2, JMP7=pin1:pin2
For JMP2=001/002/003=TD:HI, -004=TD:VSS:VSS,

Table 6. HPS252B Bill of Materials

-007	RefDes	Value	Description	Size	Part Number	MFR
2	C1, C4	10uF	Capacitor, Ceramic, 10-uF, 25-V, X5R, 20%	1206	ECJ-3YB1E106M	Panasonic
2	C2, C3	10uF	Capacitor, Ceramic, 10-uF, 6.3-V, X5R, 20%	0805	ECJ-2FB0J106M	Panasonic
1	D1	Red	Diode, LED, Red, 1.8-V, 20-mA, 20-mcd	0603	LTST-C190CKT	Liteon
1	D2	Green	Diode, LED, Green, 2.1-V, 20-mA, 6-mcd	0603	LTST-C190GKT	Liteon
1	D3	BZX84C6v2T	Diode, Zener, 6.2-V, 350-mW	SOT-23	BZX84C6V2T	Diodes
2	J1, J2, J3, J4*	ED1514	Terminal Block, 2-pin, 6-A, 3.5mm	0.27 x 0.25	ED1514	OST
5	JMP1–JMP5	PEC02SAAN	Header, 3-pin, 100mil spacing	0.100 x 3	PEC02SAAN	Sullins
2	JMP6, JMP7	PEC03SAAN	Header, 2-pin, 100mil spacing	0.100 inch x 2	PEC03SAAN	Sullins
0	R1	732	Resistor, Chip, 1/16W, 1%	0603	Std	Std
0	R10	10k	Potentiometer, 1/4 in. Cermet, 12-Turn, Top-Adjust	0.25x0.17	3266W-103LF	Bourns
1	R11	10k	Potentiometer, 1/4 in. Cermet, 12-Turn, Top-Adjust	0.25x0.17	3266W-103LF	Bourns
1	R14	301k	Resistor, Chip, 1/16W, 1%	0603	Std	Std
1	R16	50k	Potentiometer, 1/4 in. Cermet, 12-Turn, Top-Adjust	0.25x0.17	3266W-503LF	Bourns
1	R17	1k	Resistor, Chip, 1/16W, 1%	0603	Std	Std
2	R18, R20	604	Resistor, Chip, 1/16W, 1%	0603	Std	Std
0	R2	1k	Resistor, Chip, 1/16W, 1%	0603	Std	Std
0	R3	10k	Resistor, Chip, 1/16W, 1%	0603	Std	Std
1	R4	49.9k	Resistor, Chip, 1/16W, 1%	0603	Std	Std
2	R5, R6	1.5K	Resistor, Chip, 1/16W, 1%	0603	Std	Std
0	R21	1.5K	Resistor, Chip, 1/16W, 1%	0603	Std	Std
1	R22	23.7K	Resistor, Chip, 1/16W, 1%	0603	Std	Std
1	R23	11K	Resistor, Chip, 1/16W, 1%	0603	Std	Std
1	R7	100k	Resistor, Chip, 1/16W, 1%	0603	Std	Std
1	R19	0	Resistor, Chip, 1/16W, 1%	0603	Std	Std
1	R8	5k	Potentiometer, 1/4 in. Cermet, 12-Turn, Top-Adjust	0.25x0.17	3266W-502LF	Bourns
1	R9	10k	Resistor, Chip, 1/16W, 1%	0603	Std	Std
3	R12, R13, R15	10k	Resistor, Chip, 1/16W, 1%	0603	Std	Std
1	U1	BQ24075TRGT	IC, USB- Friendly Lilon Battery Charger and Power-Path Management	QFN-16	BQ24075TRGT	TI
1	--		PCB, 1.8 In x 1.7 In x 0.031 In		HPA282	Any
7		929950-00	Shunts	100 mill	Black	3M

- Notes: 1. These assemblies are ESD sensitive, ESD precautions shall be observed.
2. These assemblies must be clean and free from flux and all contaminants. Use of no clean flux is not acceptable.
3. These assemblies must comply with workmanship standards IPC-A-610 Class 2.
4. Ref designators marked with an asterisk (***) cannot be substituted.
All other components can be substituted with equivalent MFG's components.
5. * No substitutions of J1 through J4
6. Place Shunt as follows: JMP1=TRM:RES, JMP3=CE:VSS, JMP4=EN2:HI, JMP5, EN1:VSS, JMP6=pin1:pin2, JMP7=pin1:pin2

Table 7. HPA502A Bill of Materials

-001	-002	RefDes	Value	Description	Size	Part Number	MFR
2	2	C1, C4	10µF	Capacitor, Ceramic, 25-V, X5R, 20%	1206	ECJ-3YB1E106M	Panasonic
2	2	C2, C3	10µF	Capacitor, Ceramic, 6.3-V, X5R, 20%	0805	ECJ-2FB0J106M	Panasonic
1	1	D1	Red	Diode, LED, Red, 1.8-V, 20-mA, 20-mcd	0603	LTST-C190CKT	Liteon
1	1	D2	Green	Diode, LED, Green, 2.1-V, 20-mA, 6-mcd	0603	LTST-C190GKT	Liteon
1	1	D3	BZX84C6v2T	Diode, Zener, 6.2-V, 350-mW	SOT-23	BZX84C6V2T	Diodes
4	4	J1-J4*	ED1514	Terminal Block, 2-pin, 6-A, 3.5mm	0.27 x 0.25	ED1514	OST
5	5	JMP1-JMP5	PEC03SAAN	Header, 3-pin, 100mil spacing	0.100 x 3	PEC03SAAN	Sullins
2	2	JMP6, JMP7	PEC02SAAN	Header, 2-pin, 100mil spacing	0.100 inch x 2	PEC03SAAN	Sullins
0	0	R1	732	Resistor, Chip, 1/16W, 1%	0603	Std	Std
0	0	R10	10k	Potentiometer, 1/4 in. Cermet, 12-Turn, Top-Adjust	0.25 x 0.17	3266W-1-103LF	Bourns
1	1	R11	10k	Potentiometer, 1/4 in. Cermet, 12-Turn, Top-Adjust	0.25 x 0.17	3266W-1-103LF	Bourns
1	1	R14	301k	Resistor, Chip, 1/16W, 1%	0603	Std	Std
1	1	R16	50k	Potentiometer, 1/4 in. Cermet, 12-Turn, Top-Adjust	0.25 x 0.17	3266W-503	Bourns
1	1	R17	1k	Resistor, Chip, 1/16-W, 1%	0603	Std	Std
2	2	R18, R20	604	Resistor, Chip, 1/16-W, 1%	0603	Std	Std
0	0	R2	1k	Resistor, Chip, 1/16W, 1%	0603	Std	Std
0	0	R3	10k	Resistor, Chip, 1/16-W, 1%	0603	Std	Std
1	1	R4	49.9k	Resistor, Chip, 1/16-W, 1%	0603	Std	Std
2	2	R5, R6	1.5K	Resistor, Chip, 1/16-W, 1%	0603	Std	Std
0	0	R21	1.5K	Resistor, Chip, 1/16-W, 1%	0603	Std	Std
0	1	R22	2.7K	Resistor, Chip, 1/16-W, 1%	0603	Std	Std
0	1	R23	11K	Resistor, Chip, 1/16-W, 1%	0603	Std	Std
0	1	R7	100k	Resistor, Chip, 1/16-W, 1%	0603	Std	Std
1	0	R7	0	Resistor, Chip, 1/16-W, 1%	0603	Std	Std
1	1	R19	0	Resistor, Chip, 1/16-W, 1%	0603	Std	Std
1	1	R8	5k	Potentiometer, 1/4 in. Cermet, 12-Turn, Top-Adjust	0.25 x 0.17	3266W-1-502LF	Bourns
1	0	R9	10k	Resistor, Chip, 1/16W, 1%	0603	Std	Std
3	3	R12, R13, R15	10k	Resistor, Chip, 1/16W, 1%	0603	Std	Std
1	0	U1	BQ24079RGT	IC, USB- Friendly Li-Ion Battery Charger and Power-Path Management- Current based TS	QFN-16	BQ24079RGT	TI
0	1	U1	BQ24079TRGT	IC, USB- Friendly Li-Ion Battery Charger and Power-Path Management - Current based TS	QFN-16	BQ24079TRGT	TI
1	1	-		PCB, 1.8 In x 1.7 In x 0.031 In		HPA502	Any
7	7		929950-00	Shunts	100 mill	929950-00	3M

Notes: 1. These assemblies are ESD sensitive, ESD precautions shall be observed.
2. These assemblies must be clean and free from flux and all contaminants. Use of no clean flux is not acceptable.
3. These assemblies must comply with workmanship standards IPC-A-610 Class 2.
4. Ref designators marked with an asterisk (***) cannot be substituted.
All other components can be substituted with equivalent MFG's components.
5. * No substitutions of J1 through J4
6. Place Shunt as follows: JMP1=TRM:RES, JMP2=TD:VSS, JMP3=CE:VSS, JMP4=EN2:HI, JMP5, EN1:VSS, JMP6=pin1:pin2, JMP7=pin1:pin2

8 References

1. *bq24072/3/4/5/9(T), 1.2A USB-Friendly Li-Ion Battery Charger and Power-Path Management IC data sheet* [SLUS810](#)
2. *bq24075T, bq24079T, 1.5A USB-Friendly Li-Ion Battery Charger and Power-Path Management IC data sheet* ([SLUS937](#))

Revision History

NOTE: Page numbers for previous revisions may differ from page numbers in the current version.

Changes from D Revision (September 2016) to E Revision	Page
• Changed From: TMR JMP2 To: TMR JMP1 in Figure 1	5

Revision History

Changes from C Revision (May 2010) to D Revision	Page
• Changed the orientation of Figure 6	9

Revision History

Changes from B Revision (February 2010) to C Revision	Page
• Added devices bq24072TRGTR and bq24072TRGTT in the <i>Ordering Information</i> table	2

Revision History

Changes from A Revision (July 2009) to B Revision	Page
• Changed Figure 6	9
• Changed Figure 7	10
• Changed Figure 8	11
• Changed the <i>Bill of Materials</i> section	12

Revision History

Changes from Original (November 2008) to A Revision	Page
• Changed devices From: bq24079RGTT to bq24079TRGTT in the <i>Ordering Information</i> table	2
• Changed Figure 1	5

STANDARD TERMS FOR EVALUATION MODULES

1. *Delivery:* TI delivers TI evaluation boards, kits, or modules, including any accompanying demonstration software, components, and/or documentation which may be provided together or separately (collectively, an "EVM" or "EVMs") to the User ("User") in accordance with the terms set forth herein. User's acceptance of the EVM is expressly subject to the following terms.
 - 1.1 EVMs are intended solely for product or software developers for use in a research and development setting to facilitate feasibility evaluation, experimentation, or scientific analysis of TI semiconductor products. EVMs have no direct function and are not finished products. EVMs shall not be directly or indirectly assembled as a part or subassembly in any finished product. For clarification, any software or software tools provided with the EVM ("Software") shall not be subject to the terms and conditions set forth herein but rather shall be subject to the applicable terms that accompany such Software
 - 1.2 EVMs are not intended for consumer or household use. EVMs may not be sold, sublicensed, leased, rented, loaned, assigned, or otherwise distributed for commercial purposes by Users, in whole or in part, or used in any finished product or production system.
2. *Limited Warranty and Related Remedies/Disclaimers:*
 - 2.1 These terms do not apply to Software. The warranty, if any, for Software is covered in the applicable Software License Agreement.
 - 2.2 TI warrants that the TI EVM will conform to TI's published specifications for ninety (90) days after the date TI delivers such EVM to User. Notwithstanding the foregoing, TI shall not be liable for a nonconforming EVM if (a) the nonconformity was caused by neglect, misuse or mistreatment by an entity other than TI, including improper installation or testing, or for any EVMs that have been altered or modified in any way by an entity other than TI, (b) the nonconformity resulted from User's design, specifications or instructions for such EVMs or improper system design, or (c) User has not paid on time. Testing and other quality control techniques are used to the extent TI deems necessary. TI does not test all parameters of each EVM. User's claims against TI under this Section 2 are void if User fails to notify TI of any apparent defects in the EVMs within ten (10) business days after delivery, or of any hidden defects with ten (10) business days after the defect has been detected.
 - 2.3 TI's sole liability shall be at its option to repair or replace EVMs that fail to conform to the warranty set forth above, or credit User's account for such EVM. TI's liability under this warranty shall be limited to EVMs that are returned during the warranty period to the address designated by TI and that are determined by TI not to conform to such warranty. If TI elects to repair or replace such EVM, TI shall have a reasonable time to repair such EVM or provide replacements. Repaired EVMs shall be warranted for the remainder of the original warranty period. Replaced EVMs shall be warranted for a new full ninety (90) day warranty period.
3. *Regulatory Notices:*
 - 3.1 *United States*
 - 3.1.1 *Notice applicable to EVMs not FCC-Approved:*

FCC NOTICE: This kit is designed to allow product developers to evaluate electronic components, circuitry, or software associated with the kit to determine whether to incorporate such items in a finished product and software developers to write software applications for use with the end product. This kit is not a finished product and when assembled may not be resold or otherwise marketed unless all required FCC equipment authorizations are first obtained. Operation is subject to the condition that this product not cause harmful interference to licensed radio stations and that this product accept harmful interference. Unless the assembled kit is designed to operate under part 15, part 18 or part 95 of this chapter, the operator of the kit must operate under the authority of an FCC license holder or must secure an experimental authorization under part 5 of this chapter.
 - 3.1.2 *For EVMs annotated as FCC – FEDERAL COMMUNICATIONS COMMISSION Part 15 Compliant:*

CAUTION

This device complies with part 15 of the FCC Rules. Operation is subject to the following two conditions: (1) This device may not cause harmful interference, and (2) this device must accept any interference received, including interference that may cause undesired operation.

Changes or modifications not expressly approved by the party responsible for compliance could void the user's authority to operate the equipment.

FCC Interference Statement for Class A EVM devices

NOTE: This equipment has been tested and found to comply with the limits for a Class A digital device, pursuant to part 15 of the FCC Rules. These limits are designed to provide reasonable protection against harmful interference when the equipment is operated in a commercial environment. This equipment generates, uses, and can radiate radio frequency energy and, if not installed and used in accordance with the instruction manual, may cause harmful interference to radio communications. Operation of this equipment in a residential area is likely to cause harmful interference in which case the user will be required to correct the interference at his own expense.

FCC Interference Statement for Class B EVM devices

NOTE: This equipment has been tested and found to comply with the limits for a Class B digital device, pursuant to part 15 of the FCC Rules. These limits are designed to provide reasonable protection against harmful interference in a residential installation. This equipment generates, uses and can radiate radio frequency energy and, if not installed and used in accordance with the instructions, may cause harmful interference to radio communications. However, there is no guarantee that interference will not occur in a particular installation. If this equipment does cause harmful interference to radio or television reception, which can be determined by turning the equipment off and on, the user is encouraged to try to correct the interference by one or more of the following measures:

- Reorient or relocate the receiving antenna.
- Increase the separation between the equipment and receiver.
- Connect the equipment into an outlet on a circuit different from that to which the receiver is connected.
- Consult the dealer or an experienced radio/TV technician for help.

3.2 Canada

3.2.1 For EVMs issued with an Industry Canada Certificate of Conformance to RSS-210

Concerning EVMs Including Radio Transmitters:

This device complies with Industry Canada license-exempt RSS standard(s). Operation is subject to the following two conditions: (1) this device may not cause interference, and (2) this device must accept any interference, including interference that may cause undesired operation of the device.

Concernant les EVMs avec appareils radio:

Le présent appareil est conforme aux CNR d'Industrie Canada applicables aux appareils radio exempts de licence. L'exploitation est autorisée aux deux conditions suivantes: (1) l'appareil ne doit pas produire de brouillage, et (2) l'utilisateur de l'appareil doit accepter tout brouillage radioélectrique subi, même si le brouillage est susceptible d'en compromettre le fonctionnement.

Concerning EVMs Including Detachable Antennas:

Under Industry Canada regulations, this radio transmitter may only operate using an antenna of a type and maximum (or lesser) gain approved for the transmitter by Industry Canada. To reduce potential radio interference to other users, the antenna type and its gain should be so chosen that the equivalent isotropically radiated power (e.i.r.p.) is not more than that necessary for successful communication. This radio transmitter has been approved by Industry Canada to operate with the antenna types listed in the user guide with the maximum permissible gain and required antenna impedance for each antenna type indicated. Antenna types not included in this list, having a gain greater than the maximum gain indicated for that type, are strictly prohibited for use with this device.

Concernant les EVMs avec antennes détachables

Conformément à la réglementation d'Industrie Canada, le présent émetteur radio peut fonctionner avec une antenne d'un type et d'un gain maximal (ou inférieur) approuvé pour l'émetteur par Industrie Canada. Dans le but de réduire les risques de brouillage radioélectrique à l'intention des autres utilisateurs, il faut choisir le type d'antenne et son gain de sorte que la puissance isotrope rayonnée équivalente (p.i.r.e.) ne dépasse pas l'intensité nécessaire à l'établissement d'une communication satisfaisante. Le présent émetteur radio a été approuvé par Industrie Canada pour fonctionner avec les types d'antenne énumérés dans le manuel d'usage et ayant un gain admissible maximal et l'impédance requise pour chaque type d'antenne. Les types d'antenne non inclus dans cette liste, ou dont le gain est supérieur au gain maximal indiqué, sont strictement interdits pour l'exploitation de l'émetteur.

3.3 Japan

3.3.1 *Notice for EVMs delivered in Japan:* Please see http://www.tij.co.jp/lstds/ti_ja/general/eStore/notice_01.page 日本国内に輸入される評価用キット、ボードについては、次のところをご覧ください。
http://www.tij.co.jp/lstds/ti_ja/general/eStore/notice_01.page

3.3.2 *Notice for Users of EVMs Considered "Radio Frequency Products" in Japan:* EVMs entering Japan may not be certified by TI as conforming to Technical Regulations of Radio Law of Japan.

If User uses EVMs in Japan, not certified to Technical Regulations of Radio Law of Japan, User is required to follow the instructions set forth by Radio Law of Japan, which includes, but is not limited to, the instructions below with respect to EVMs (which for the avoidance of doubt are stated strictly for convenience and should be verified by User):

1. Use EVMs in a shielded room or any other test facility as defined in the notification #173 issued by Ministry of Internal Affairs and Communications on March 28, 2006, based on Sub-section 1.1 of Article 6 of the Ministry's Rule for Enforcement of Radio Law of Japan,
2. Use EVMs only after User obtains the license of Test Radio Station as provided in Radio Law of Japan with respect to EVMs, or
3. Use of EVMs only after User obtains the Technical Regulations Conformity Certification as provided in Radio Law of Japan with respect to EVMs. Also, do not transfer EVMs, unless User gives the same notice above to the transferee. Please note that if User does not follow the instructions above, User will be subject to penalties of Radio Law of Japan.

【無線電波を送信する製品の開発キットをお使いになる際の注意事項】 開発キットの中には技術基準適合証明を受けていないものがあります。技術適合証明を受けていないもののご使用に際しては、電波法遵守のため、以下のいずれかの措置を取っていただく必要がありますのでご注意ください。

1. 電波法施行規則第6条第1項第1号に基づく平成18年3月28日総務省告示第173号で定められた電波暗室等の試験設備でご使用いただく。
2. 実験局の免許を取得後ご使用いただく。
3. 技術基準適合証明を取得後ご使用いただく。

なお、本製品は、上記の「ご使用にあたっての注意」を譲渡先、移転先に通知しない限り、譲渡、移転できないものとします。

上記を遵守頂けない場合は、電波法の罰則が適用される可能性があることをご留意ください。日本テキサス・インスツルメンツ株式会社
東京都新宿区西新宿6丁目2番1号
西新宿三井ビル

3.3.3 *Notice for EVMs for Power Line Communication:* Please see http://www.tij.co.jp/lstds/ti_ja/general/eStore/notice_02.page
電力線搬送波通信についての開発キットをお使いになる際の注意事項については、次のところをご覧ください。 http://www.tij.co.jp/lstds/ti_ja/general/eStore/notice_02.page

4 *EVM Use Restrictions and Warnings:*

4.1 EVMS ARE NOT FOR USE IN FUNCTIONAL SAFETY AND/OR SAFETY CRITICAL EVALUATIONS, INCLUDING BUT NOT LIMITED TO EVALUATIONS OF LIFE SUPPORT APPLICATIONS.

4.2 User must read and apply the user guide and other available documentation provided by TI regarding the EVM prior to handling or using the EVM, including without limitation any warning or restriction notices. The notices contain important safety information related to, for example, temperatures and voltages.

4.3 *Safety-Related Warnings and Restrictions:*

4.3.1 User shall operate the EVM within TI's recommended specifications and environmental considerations stated in the user guide, other available documentation provided by TI, and any other applicable requirements and employ reasonable and customary safeguards. Exceeding the specified performance ratings and specifications (including but not limited to input and output voltage, current, power, and environmental ranges) for the EVM may cause personal injury or death, or property damage. If there are questions concerning performance ratings and specifications, User should contact a TI field representative prior to connecting interface electronics including input power and intended loads. Any loads applied outside of the specified output range may also result in unintended and/or inaccurate operation and/or possible permanent damage to the EVM and/or interface electronics. Please consult the EVM user guide prior to connecting any load to the EVM output. If there is uncertainty as to the load specification, please contact a TI field representative. During normal operation, even with the inputs and outputs kept within the specified allowable ranges, some circuit components may have elevated case temperatures. These components include but are not limited to linear regulators, switching transistors, pass transistors, current sense resistors, and heat sinks, which can be identified using the information in the associated documentation. When working with the EVM, please be aware that the EVM may become very warm.

4.3.2 EVMs are intended solely for use by technically qualified, professional electronics experts who are familiar with the dangers and application risks associated with handling electrical mechanical components, systems, and subsystems. User assumes all responsibility and liability for proper and safe handling and use of the EVM by User or its employees, affiliates, contractors or designees. User assumes all responsibility and liability to ensure that any interfaces (electronic and/or mechanical) between the EVM and any human body are designed with suitable isolation and means to safely limit accessible leakage currents to minimize the risk of electrical shock hazard. User assumes all responsibility and liability for any improper or unsafe handling or use of the EVM by User or its employees, affiliates, contractors or designees.

4.4 User assumes all responsibility and liability to determine whether the EVM is subject to any applicable international, federal, state, or local laws and regulations related to User's handling and use of the EVM and, if applicable, User assumes all responsibility and liability for compliance in all respects with such laws and regulations. User assumes all responsibility and liability for proper disposal and recycling of the EVM consistent with all applicable international, federal, state, and local requirements.

5. *Accuracy of Information:* To the extent TI provides information on the availability and function of EVMs, TI attempts to be as accurate as possible. However, TI does not warrant the accuracy of EVM descriptions, EVM availability or other information on its websites as accurate, complete, reliable, current, or error-free.

6. *Disclaimers:*

6.1 EXCEPT AS SET FORTH ABOVE, EVMS AND ANY MATERIALS PROVIDED WITH THE EVM (INCLUDING, BUT NOT LIMITED TO, REFERENCE DESIGNS AND THE DESIGN OF THE EVM ITSELF) ARE PROVIDED "AS IS" AND "WITH ALL FAULTS." TI DISCLAIMS ALL OTHER WARRANTIES, EXPRESS OR IMPLIED, REGARDING SUCH ITEMS, INCLUDING BUT NOT LIMITED TO ANY EPIDEMIC FAILURE WARRANTY OR IMPLIED WARRANTIES OF MERCHANTABILITY OR FITNESS FOR A PARTICULAR PURPOSE OR NON-INFRINGEMENT OF ANY THIRD PARTY PATENTS, COPYRIGHTS, TRADE SECRETS OR OTHER INTELLECTUAL PROPERTY RIGHTS.

6.2 EXCEPT FOR THE LIMITED RIGHT TO USE THE EVM SET FORTH HEREIN, NOTHING IN THESE TERMS SHALL BE CONSTRUED AS GRANTING OR CONFERRING ANY RIGHTS BY LICENSE, PATENT, OR ANY OTHER INDUSTRIAL OR INTELLECTUAL PROPERTY RIGHT OF TI, ITS SUPPLIERS/LICENSORS OR ANY OTHER THIRD PARTY, TO USE THE EVM IN ANY FINISHED END-USER OR READY-TO-USE FINAL PRODUCT, OR FOR ANY INVENTION, DISCOVERY OR IMPROVEMENT, REGARDLESS OF WHEN MADE, CONCEIVED OR ACQUIRED.

7. *USER'S INDEMNITY OBLIGATIONS AND REPRESENTATIONS.* USER WILL DEFEND, INDEMNIFY AND HOLD TI, ITS LICENSORS AND THEIR REPRESENTATIVES HARMLESS FROM AND AGAINST ANY AND ALL CLAIMS, DAMAGES, LOSSES, EXPENSES, COSTS AND LIABILITIES (COLLECTIVELY, "CLAIMS") ARISING OUT OF OR IN CONNECTION WITH ANY HANDLING OR USE OF THE EVM THAT IS NOT IN ACCORDANCE WITH THESE TERMS. THIS OBLIGATION SHALL APPLY WHETHER CLAIMS ARISE UNDER STATUTE, REGULATION, OR THE LAW OF TORT, CONTRACT OR ANY OTHER LEGAL THEORY, AND EVEN IF THE EVM FAILS TO PERFORM AS DESCRIBED OR EXPECTED.

8. *Limitations on Damages and Liability:*

8.1 *General Limitations.* IN NO EVENT SHALL TI BE LIABLE FOR ANY SPECIAL, COLLATERAL, INDIRECT, PUNITIVE, INCIDENTAL, CONSEQUENTIAL, OR EXEMPLARY DAMAGES IN CONNECTION WITH OR ARISING OUT OF THESE TERMS OR THE USE OF THE EVMS, REGARDLESS OF WHETHER TI HAS BEEN ADVISED OF THE POSSIBILITY OF SUCH DAMAGES. EXCLUDED DAMAGES INCLUDE, BUT ARE NOT LIMITED TO, COST OF REMOVAL OR REINSTALLATION, ANCILLARY COSTS TO THE PROCUREMENT OF SUBSTITUTE GOODS OR SERVICES, RETESTING, OUTSIDE COMPUTER TIME, LABOR COSTS, LOSS OF GOODWILL, LOSS OF PROFITS, LOSS OF SAVINGS, LOSS OF USE, LOSS OF DATA, OR BUSINESS INTERRUPTION. NO CLAIM, SUIT OR ACTION SHALL BE BROUGHT AGAINST TI MORE THAN TWELVE (12) MONTHS AFTER THE EVENT THAT GAVE RISE TO THE CAUSE OF ACTION HAS OCCURRED.

8.2 *Specific Limitations.* IN NO EVENT SHALL TI'S AGGREGATE LIABILITY FROM ANY USE OF AN EVM PROVIDED HEREUNDER, INCLUDING FROM ANY WARRANTY, INDEMNITY OR OTHER OBLIGATION ARISING OUT OF OR IN CONNECTION WITH THESE TERMS, EXCEED THE TOTAL AMOUNT PAID TO TI BY USER FOR THE PARTICULAR EVM(S) AT ISSUE DURING THE PRIOR TWELVE (12) MONTHS WITH RESPECT TO WHICH LOSSES OR DAMAGES ARE CLAIMED. THE EXISTENCE OF MORE THAN ONE CLAIM SHALL NOT ENLARGE OR EXTEND THIS LIMIT.

9. *Return Policy.* Except as otherwise provided, TI does not offer any refunds, returns, or exchanges. Furthermore, no return of EVM(s) will be accepted if the package has been opened and no return of the EVM(s) will be accepted if they are damaged or otherwise not in a resalable condition. If User feels it has been incorrectly charged for the EVM(s) it ordered or that delivery violates the applicable order, User should contact TI. All refunds will be made in full within thirty (30) working days from the return of the components(s), excluding any postage or packaging costs.

10. *Governing Law:* These terms and conditions shall be governed by and interpreted in accordance with the laws of the State of Texas, without reference to conflict-of-laws principles. User agrees that non-exclusive jurisdiction for any dispute arising out of or relating to these terms and conditions lies within courts located in the State of Texas and consents to venue in Dallas County, Texas. Notwithstanding the foregoing, any judgment may be enforced in any United States or foreign court, and TI may seek injunctive relief in any United States or foreign court.

IMPORTANT NOTICE FOR TI DESIGN INFORMATION AND RESOURCES

Texas Instruments Incorporated ("TI") technical, application or other design advice, services or information, including, but not limited to, reference designs and materials relating to evaluation modules, (collectively, "TI Resources") are intended to assist designers who are developing applications that incorporate TI products; by downloading, accessing or using any particular TI Resource in any way, you (individually or, if you are acting on behalf of a company, your company) agree to use it solely for this purpose and subject to the terms of this Notice.

TI's provision of TI Resources does not expand or otherwise alter TI's applicable published warranties or warranty disclaimers for TI products, and no additional obligations or liabilities arise from TI providing such TI Resources. TI reserves the right to make corrections, enhancements, improvements and other changes to its TI Resources.

You understand and agree that you remain responsible for using your independent analysis, evaluation and judgment in designing your applications and that you have full and exclusive responsibility to assure the safety of your applications and compliance of your applications (and of all TI products used in or for your applications) with all applicable regulations, laws and other applicable requirements. You represent that, with respect to your applications, you have all the necessary expertise to create and implement safeguards that (1) anticipate dangerous consequences of failures, (2) monitor failures and their consequences, and (3) lessen the likelihood of failures that might cause harm and take appropriate actions. You agree that prior to using or distributing any applications that include TI products, you will thoroughly test such applications and the functionality of such TI products as used in such applications. TI has not conducted any testing other than that specifically described in the published documentation for a particular TI Resource.

You are authorized to use, copy and modify any individual TI Resource only in connection with the development of applications that include the TI product(s) identified in such TI Resource. NO OTHER LICENSE, EXPRESS OR IMPLIED, BY ESTOPPEL OR OTHERWISE TO ANY OTHER TI INTELLECTUAL PROPERTY RIGHT, AND NO LICENSE TO ANY TECHNOLOGY OR INTELLECTUAL PROPERTY RIGHT OF TI OR ANY THIRD PARTY IS GRANTED HEREIN, including but not limited to any patent right, copyright, mask work right, or other intellectual property right relating to any combination, machine, or process in which TI products or services are used. Information regarding or referencing third-party products or services does not constitute a license to use such products or services, or a warranty or endorsement thereof. Use of TI Resources may require a license from a third party under the patents or other intellectual property of the third party, or a license from TI under the patents or other intellectual property of TI.

TI RESOURCES ARE PROVIDED "AS IS" AND WITH ALL FAULTS. TI DISCLAIMS ALL OTHER WARRANTIES OR REPRESENTATIONS, EXPRESS OR IMPLIED, REGARDING TI RESOURCES OR USE THEREOF, INCLUDING BUT NOT LIMITED TO ACCURACY OR COMPLETENESS, TITLE, ANY EPIDEMIC FAILURE WARRANTY AND ANY IMPLIED WARRANTIES OF MERCHANTABILITY, FITNESS FOR A PARTICULAR PURPOSE, AND NON-INFRINGEMENT OF ANY THIRD PARTY INTELLECTUAL PROPERTY RIGHTS.

TI SHALL NOT BE LIABLE FOR AND SHALL NOT DEFEND OR INDEMNIFY YOU AGAINST ANY CLAIM, INCLUDING BUT NOT LIMITED TO ANY INFRINGEMENT CLAIM THAT RELATES TO OR IS BASED ON ANY COMBINATION OF PRODUCTS EVEN IF DESCRIBED IN TI RESOURCES OR OTHERWISE. IN NO EVENT SHALL TI BE LIABLE FOR ANY ACTUAL, DIRECT, SPECIAL, COLLATERAL, INDIRECT, PUNITIVE, INCIDENTAL, CONSEQUENTIAL OR EXEMPLARY DAMAGES IN CONNECTION WITH OR ARISING OUT OF TI RESOURCES OR USE THEREOF, AND REGARDLESS OF WHETHER TI HAS BEEN ADVISED OF THE POSSIBILITY OF SUCH DAMAGES.

You agree to fully indemnify TI and its representatives against any damages, costs, losses, and/or liabilities arising out of your non-compliance with the terms and provisions of this Notice.

This Notice applies to TI Resources. Additional terms apply to the use and purchase of certain types of materials, TI products and services. These include; without limitation, TI's standard terms for semiconductor products (<http://www.ti.com/sc/docs/stdterms.htm>), [evaluation modules](#), and [samples](http://www.ti.com/sc/docs/sampterm.htm) (<http://www.ti.com/sc/docs/sampterm.htm>).

Mailing Address: Texas Instruments, Post Office Box 655303, Dallas, Texas 75265
Copyright © 2017, Texas Instruments Incorporated