

TPS61181EVM-259 / TPS61182EVM-259

This user's guide describes the characteristics, operation, and use of the TPS6118xEVM-259 evaluation module (EVM). This EVM contains either Texas Instruments' TPS61181 (-001 build) or TPS61182 (-002 build) or TPS61181A (-003 build)-based WLED power solutions, each of which provides up to six independently regulated current outputs using a single inductor step-up (boost) converter. The current outputs are ideal for driving a WLED backlight in notebook/laptop computers. A separate EVM, WLEDEVM-260, contains eight strings of 10 series WLEDs and connects to the TPS6118x EVMs via a 14-pin ribbon cable to simplify evaluation. This user's guide includes EVM specifications, recommended test setup, test results, bill of materials, and a schematic diagram for the TPS61181/2/1AEVM.

Contents

1	Introduction	2
2	Input/Output Connector Descriptions	3
3	Board Layout	7
4	Schematic and Bill of Materials	9

List of Figures

1	Efficiency vs Total WLED Output Current	4
2	Dimming Linearity	4
3	Start-up	5
4	Switching Waveform	5
5	Output Ripple at PWM Dimming with $C_o = 4.7 \mu\text{F}$	6
6	Top Assembly Layer	7
7	Top Layer	7
8	Bottom Layer	8
9	HPA259A Schematic	9

List of Tables

1	Typical Performance Specification Summary	2
2	HPA259 Bill of Materials	10

1 Introduction

This EVM contains either Texas Instruments' TPS61181 (-001 build) or TPS61182 (-002 build) or TPS61181A (-003 build) based WLED power solution, each of which provides up to six independently regulated current outputs using a single inductor step-up (boost) converter. The current outputs are ideal for driving a WLED backlight in notebook/laptop computers. A separate EVM, WLEDEV-260 ([SLVU238](#)), contains six strings of 12 series WLEDs and connects to the TPS6118xEVM via a 14-pin ribbon cable to simplify evaluation. The goal of these EVMs is to facilitate evaluation of the TPS6118x integrated circuit (IC) in a typical WLED application.

1.1 Performance Specification Summary

[Table 1](#) provides a summary of the TPS6118xEVM-259 performance specifications. All specifications are given for an ambient temperature of 25°C.

Table 1. Typical Performance Specification Summary

	CONDITION	MIN	TYP	MAX	UNITS
V _{BAT} supply	TPS61181, TPS61182	5		24	V
V _{BAT} supply	TPS61181A	4.5		24	V
EN logic high	TPS61181, TPS61182	1.2		6	V
EN logic high	TPS61181A	2.0		18	V
V _(TP5)	J8 connected to 10 WLED configured WLEDEV-260, JP13 shorted, JPFbXS open, V _{BAT} supplied, EN = 3.3V, DCTRL = V _{CC}		30	35	V
	J8 connected to 10 WLED configured WLEDEV-260, JP13 open, JPFbXS open, V _{BAT} supplied, EN = 3.3V, DCTRL = V _{CC}	38	39	40	
I _(JP13) = 6 X IFBx	J8 connected to 10 WLED configured WLEDEV-260, JP13 shorted, JPFbXS open, V _{BAT} = 5 V, V _{CC} supplied, EN = 3.3V, DCTRL = V _{CC}	116	120	124	mA

1.2 Modifications

To aid user customization of the EVM, the board was designed with devices having 0603 or larger footprints. A real implementation likely occupies less total board space.

Changing components can improve or degrade EVM performance. For example, using inductors with larger dc resistances lowers efficiency of the solution.

Transistor Q1, resistor R3, and diode D2 are optional but are recommended components. Transistor Q1 and resistor R3 provide input to output isolation when the IC is disabled and in the event of a fault. Diode D2 clamps inductor L1 to 0.3 V when Q1 opens in order to protect Q1 from overvoltage.

2 Input/Output Connector Descriptions

2.1 Input/Output Connections

The connection points are described in the following paragraphs.

2.1.1 J1 - VIN

This header is the positive connection to the input power supply. Twist the leads to the input supply and keep them as short as possible.

2.1.2 J2 - GND

This header is the return connection to the input power supply.

2.1.3 J3 - EN

This header connects to the IC's EN pin and must be taken logic high (above 1.2 V but no higher than 7 V) to enable the IC. Removing the logic high signal allows the internal pulldown resistor to pull EN to ground, which disables the IC.

2.1.4 J4 - CIN/VCC

For the TPS61181 and TPS61182 IC, this header provides a measurement point for the internal LDO that outputs 3.3 V on the CIN pin. For the TPS61180, an external 3.3-V supply must be applied to this pin in order for the IC to operate.

2.1.5 J5 - GND

This header connects to the board's ground plane.

2.1.6 J6 - GND

This header connects to the board's ground plane.

2.1.7 J7 - GND

This header connects to the board's ground plane.

2.1.8 J8 - 14-pin Connector

This header provides connections to the boost converter output (VOUT) and each of the six current feedback lines (IFBx). With a 14-pin ribbon cable, this header can be connected to WLEDEVM-260, containing six strings of 12 LEDs, to facilitate evaluation.

2.1.9 JP1-DCTRL

Installing this jumper ties the DCTRL dimming control pin to V_{CC} , thereby providing 100% WLED dimming or GND, thereby effectively disabling the internal current regulators. Removing the jumper allows the internal pulldown resistor to pull DCTRL to ground, which also effectively disables the internal current regulators.

2.1.10 JFB1S-JFB6S

Installing any of these jumpers shorts the corresponding internal current regulator to ground. These jumpers are intended to assist in testing the TPS61181 and TPS61182's ability to protect itself from a WLED string accidentally shorting to ground.

2.1.11 JFB1R-JFB6R

These jumpers and the corresponding series resistors are not used in testing the TPS61181 or TPS61182.

2.2 Test Setup

Connect a power supply capable of supplying up to 24 V at 1.5 A is required between the VBAT pin and GND (J1 and J2). Connect a second logic signal or power supply capable of providing 1.2 V - 7 V to the high-impedance EN pin (J3) referenced to the same ground on J2. For normal operation, JP13 should be shorted with a jumper or ammeter and multiple WLEDs connected to one or more of the IFBx lines. J8 provides a convenient connection to WLEDEV-260 (**SLVU238**) via a 14-pin ribbon, which contains six strings of 12 WLEDs each. Alternatively, external WLEDs can be connected to J2 or between jumpers JFB1S - JFB6S. If fewer than six WLEDs are needed, simply leave the unused IFBx line unconnected or short it to ground. By shorting jumpers JFB1S - JFB6S, the user can test the IC's protection against short circuits.

The TPS6118x family implements WLED dimming by replicating the PWM signal applied to DCTRL pin to the IFBx internal current regulators. A function generator capable of providing 1.2-V to 6-V maximum amplitude PWM signal between 100 Hz to 1 kHz is required to implement dimming, avoid screen flickering, and maintain dimming linearity.

2.3 Test Results

Below are the test results at $T_A = 25^\circ\text{C}$ using this EVM:

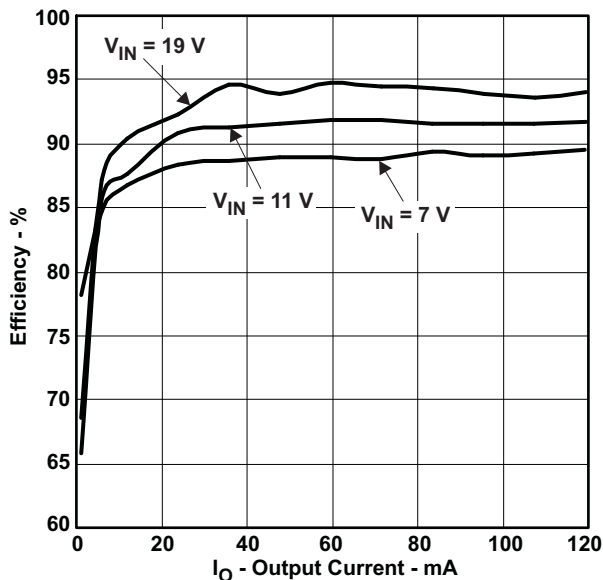

Figure 1. Efficiency vs Total WLED Output Current

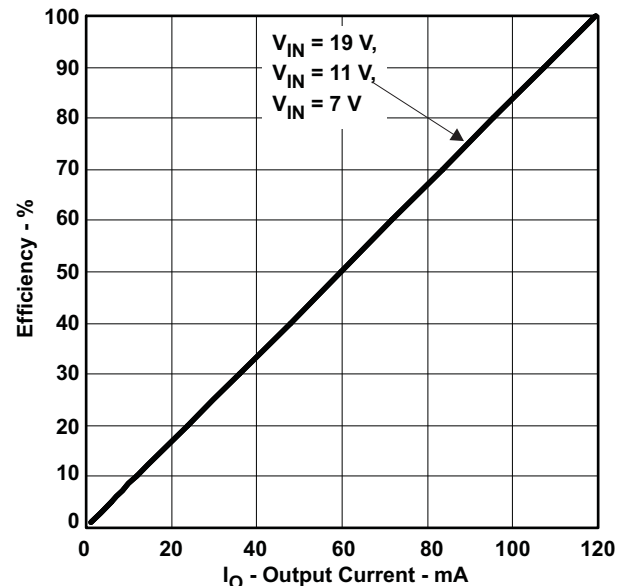

Figure 2. Dimming Linearity

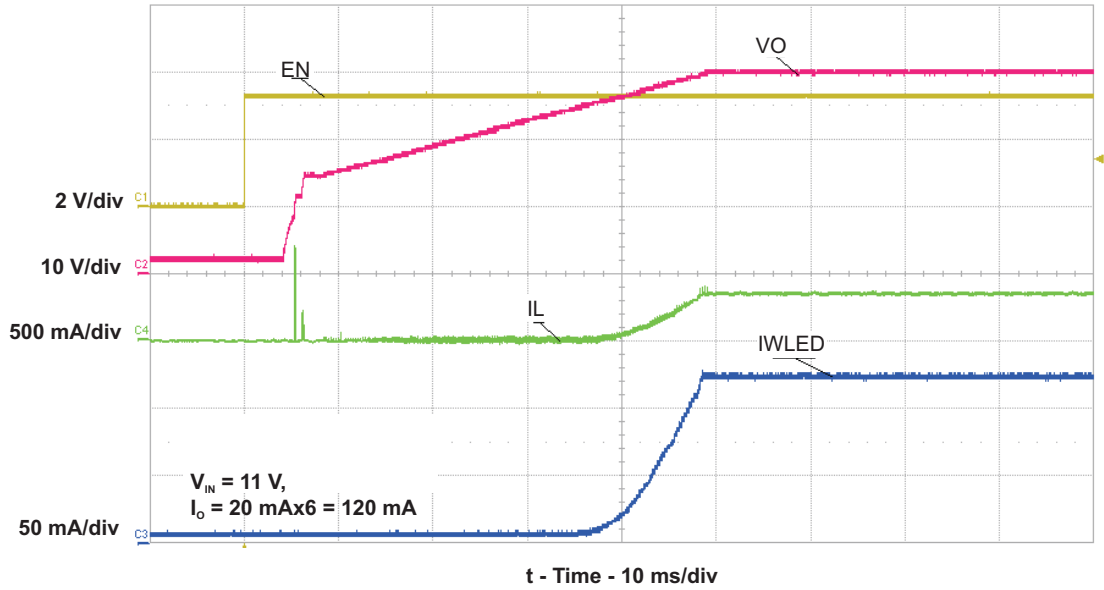

Figure 3. Start-up

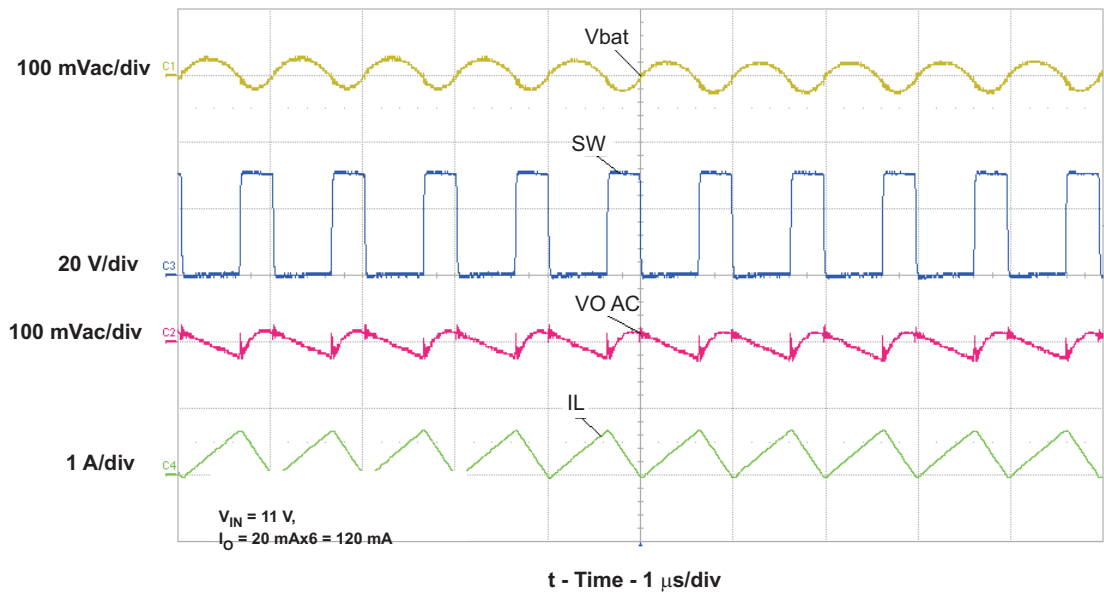

Figure 4. Switching Waveform

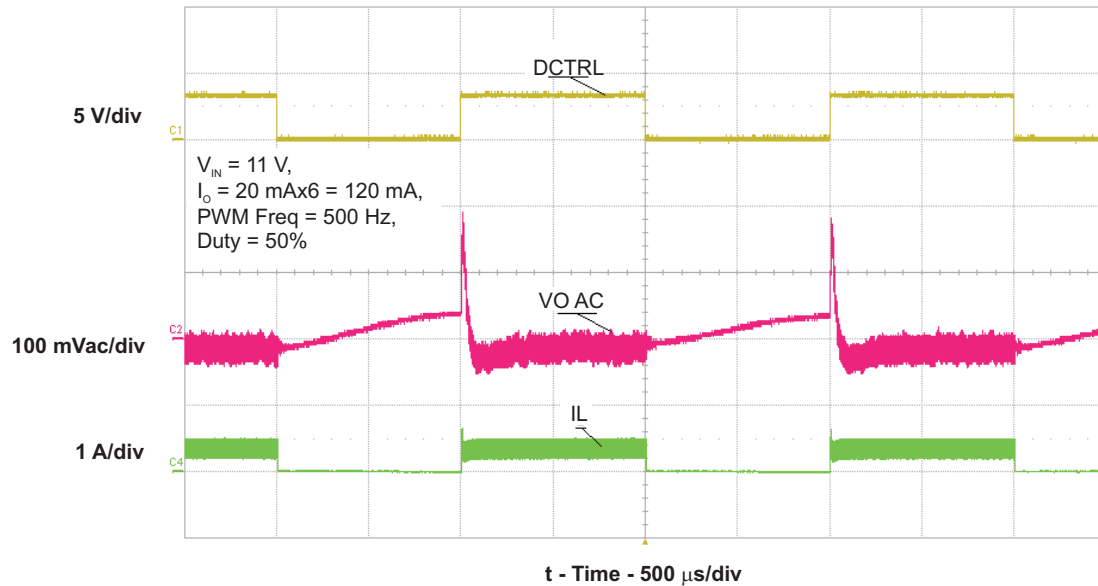

Figure 5. Output Ripple at PWM Dimming with $C_o = 4.7\ \mu\text{F}$

Note that when measuring the WLED output voltage for the efficiency computation, the output voltage from the IC's I_{OUT} pin to ground was used, which includes the voltage drop across the series ammeter, used to measure the WLED current, as well as the voltage drop across the internal current sink circuit and external current setting resistor.

3 Board Layout

Board layout is critical for all switch mode power supplies. Figure 6, Figure 7, and Figure 8 show the board layout for the HPA283 PCB. The switching nodes with high-frequency noise are isolated from the noise-sensitive feedback circuitry, and careful attention has been given to the routing of high-frequency current loops. See the data sheet for more specific layout guidelines.

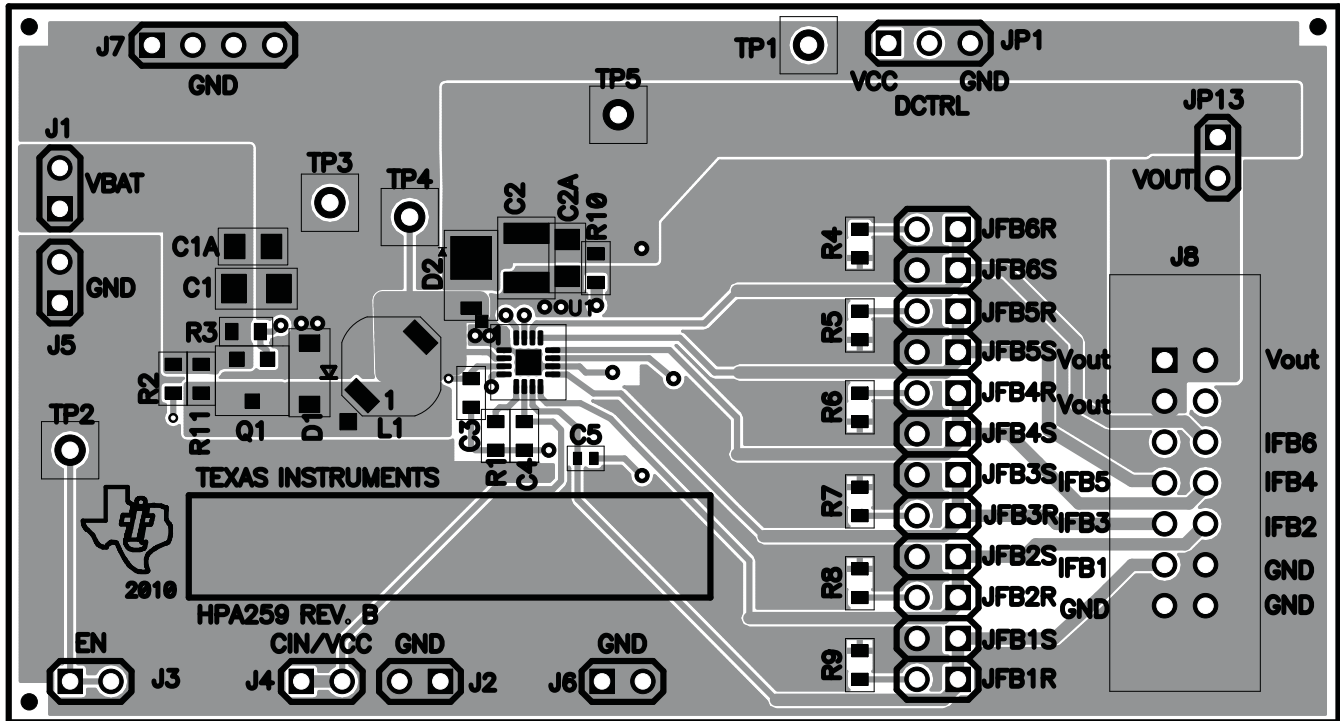

Figure 6. Top Assembly Layer

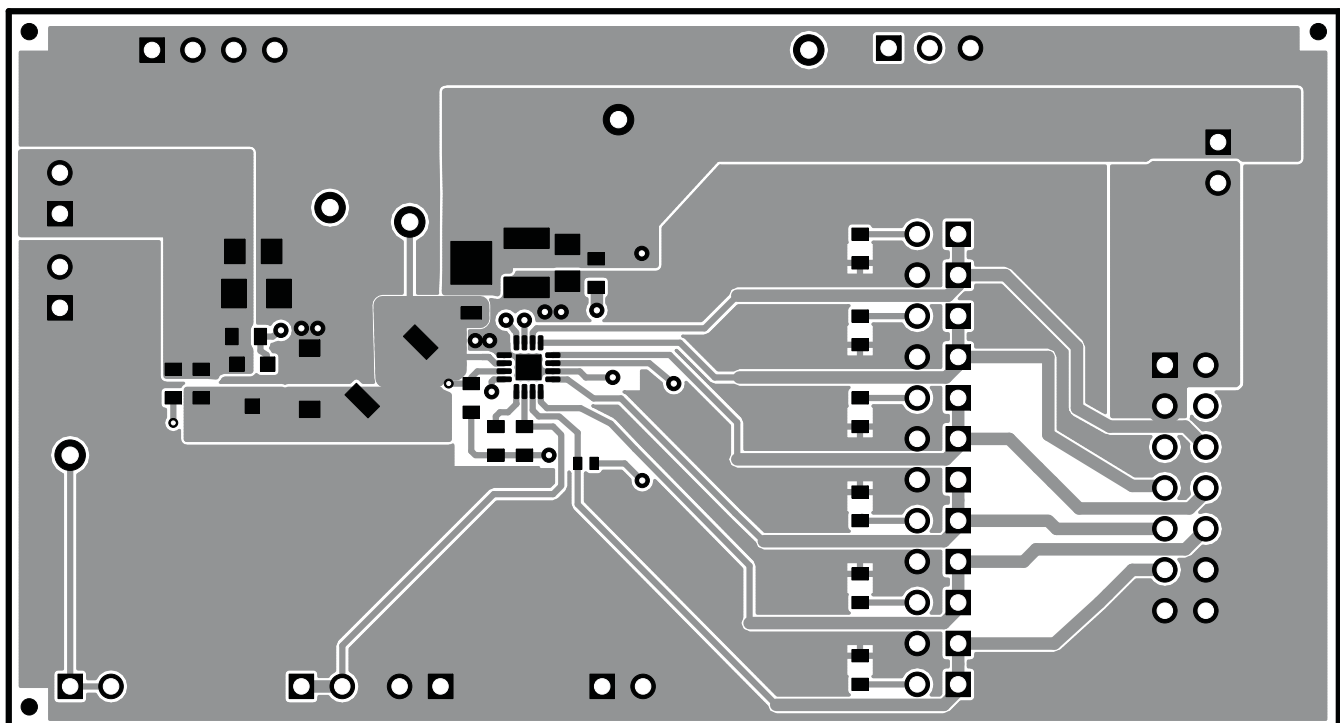

Figure 7. Top Layer

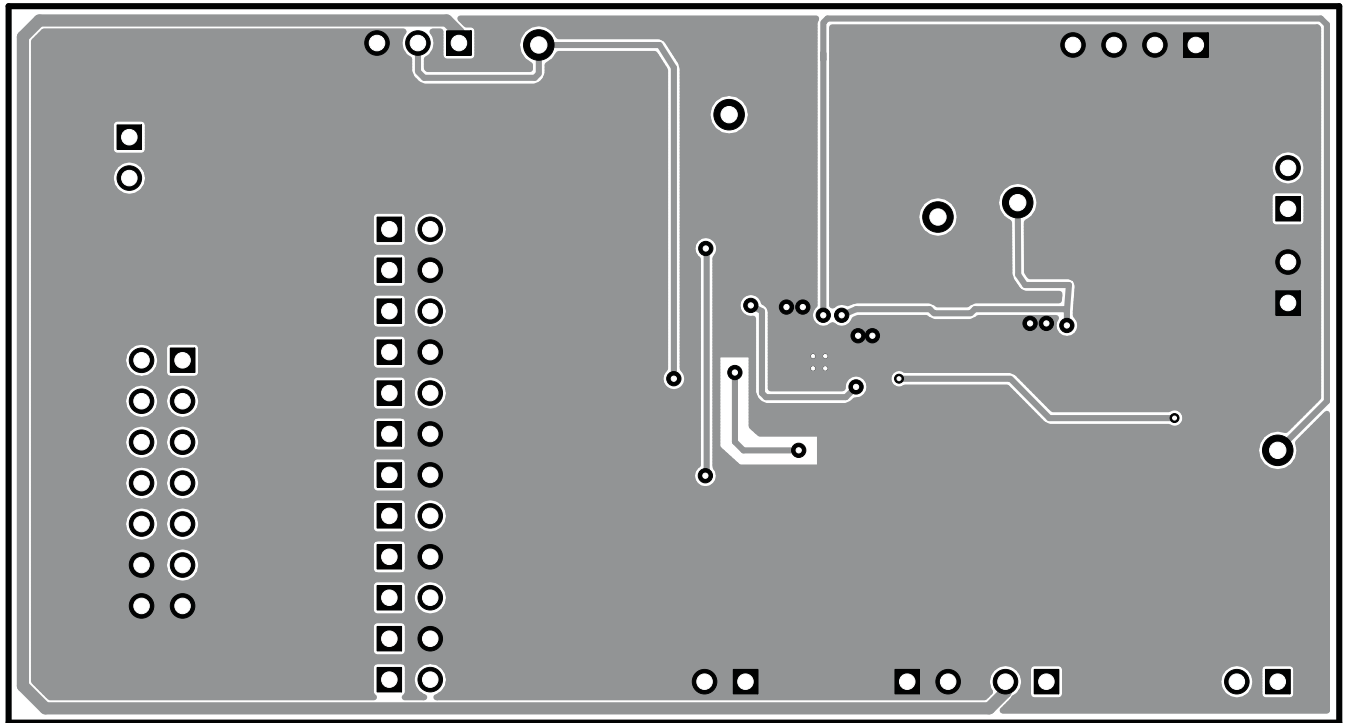

Figure 8. Bottom Layer

4 Schematic and Bill of Materials

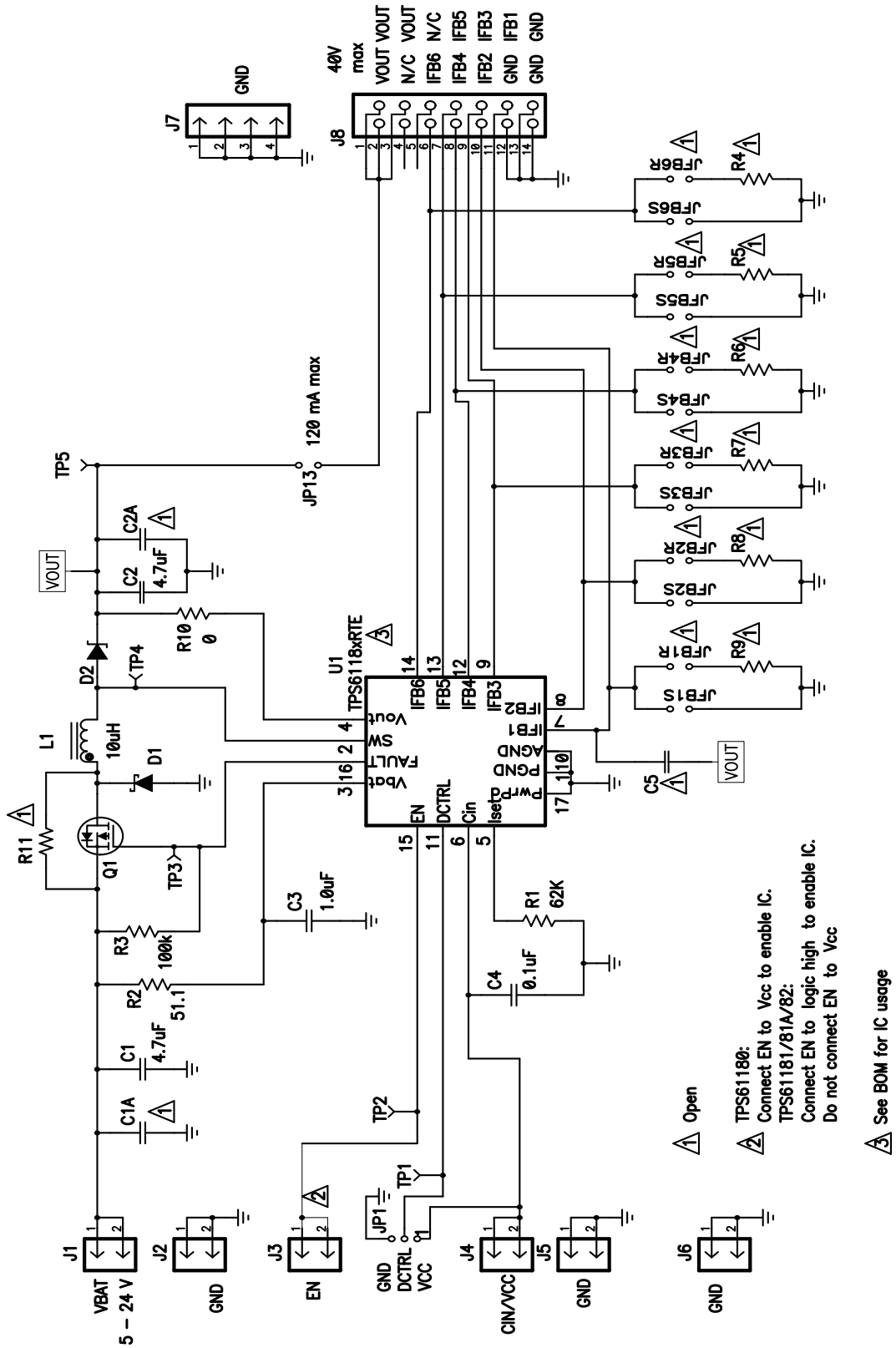

Figure 9. HPA259A Schematic

4.1 Bill of Materials

Table 2. HPA259 Bill of Materials

-001	-002	-003	RefDes	VALUE	Description	Size	Part Number
1	1	1	C1	4.7uF	Capacitor, Ceramic, 25V, X5R, 10%	1206	C1206C475K3PAC
0	0	0	C1A	Open	Capacitor, Ceramic, 25V, X5R, 10%	0805	Std
1	1	1	C2	4.7uF	Capacitor, Ceramic, 50V, X7R, 10%	1210	GRM32ER71H475KA88L
0	0	0	C2A	Open	Capacitor, Ceramic, 50V, X5R, 10%	0805	Std
1	1	1	C3	1.0uF	Capacitor, Ceramic, 25V, X5R, 10%	0603	GRM188R61E105KA12D
1	1	1	C4	0.1uF	Capacitor, Ceramic, 50V, X7R, 10%	0603	C1608X7R1H104K
0	0	0	C5	Open	Capacitor, Ceramic, 50V, X7R, +/-15%	0402	Std
1	1	1	D1	BAT54ZFILM	Diode, Schottky, 300-mA, 40-V	SOD123	BAT54ZFILM
1	1	1	D2	SS2P5-E3/84A	Diode, High Current SMD Schottky Rectifier, 2A, 50VDC	DO-220AA	SS2P5-M3/84A or alt. SS2P6-M3/84A or alt. SS2P5-E3/84A or alt. SS2P6-E3/84A See note 5
6	6	6	J1, J2, J3, J4, J5, J6	PEC02SAAN	Header, Male 2 pin, 100mil spacing	0.100 inch x 2	PEC02SAAN
1	1	1	J7	PEC04SAAN	Header, Male 4 pin, 100mil spacing	0.100 inch x 4	PEC04SAAN
1	1	1	J8	N2514-6002-RB	Connector, Male Straight 2x7 pin, 100mil spacing, 4 Wall	0.100 inch x 2X7	N2514-6002-RB
0	0	0	JFB1R1, JFB2R1, JFB3R1, JFB4R1, JFB5R1, JFB6R1	Open	Header, 2-pin, 100mil spacing	0.100 inch x 2	PEC02SAAN
6	6	6	JFB1S1, JFB2S1, JFB3S1, JFB4S1, JFB5S1, JFB6S1	PEC02SAAN	Header, 2-pin, 100mil spacing	0.100 inch x 2	PEC02SAAN
1	1	1	JP1	PEC03SAAN	Header, 3-pin, 100mil spacing	0.100 inch x 3	PEC03SAAN
1	1	1	JP13	PEC02SAAN	Header, 2-pin, 100mil spacing	0.100 inch x 2	PEC02SAAN
1	1	1	L1	10uH	10 uH Inductor, 75 ohm [90 ohm] DC resistance, ±20%	0.205 x 0.205 inch	A915AY-100M
1	1	1	Q1	Si2307BDS ALTERNATE: NTR4171P	MOSFET, P-ch, -30V, -2A, 140 milliohms	SOT23	Si2307BDS ALTERNATE: NTR4171P
1	1	1	R1	62K	Resistor, Chip, 1/16W, 1%	0603	Std
1	1	1	R10	0	Resistor, Chip, 1/16W, 1%	0603	Std
1	1	1	R2	51.1	Resistor, Chip, 1/16W, 1%	0603	Std
1	1	1	R3	100k	Resistor, Chip, 1/16W, 1%	0603	Std
0	0	0	R4, R5, R6, R7, R8, R9, R11	Open	Resistor, Chip, 1/16W, 1%	0603	Std

Table 2. HPA259 Bill of Materials (continued)

5	5	5	TP1, TP2, TP3, TP4, TP5	5000	Test Point, Red, Thru Hole Color Keyed	0.100 x 0.100 inch	5000
1	0	0	U1	TPS61181RTE	IC, WLED Driver	QFN-16	TPS61181RTE
0	1	0	U1	TPS61182RTE	IC, WLED Driver	QFN-16	TPS61182RTE
0	0	1	U1	TPS61181ARTE	IC, WLED Driver	QFN-16	TPS61181ARTE
1	1	1	–		Label (See Note 6)	1.25 x 0.25 inch	THT-13-457-10
8	8	8	–		Shunt, 100 mil, Black	0.1	929950-00
1	1	1	–		PCB, 3.25 In x 1.75 In x 0.062 In		HPA259

Evaluation Board/Kit Important Notice

Texas Instruments (TI) provides the enclosed product(s) under the following conditions:

This evaluation board/kit is intended for use for **ENGINEERING DEVELOPMENT, DEMONSTRATION, OR EVALUATION PURPOSES ONLY** and is not considered by TI to be a finished end-product fit for general consumer use. Persons handling the product(s) must have electronics training and observe good engineering practice standards. As such, the goods being provided are not intended to be complete in terms of required design-, marketing-, and/or manufacturing-related protective considerations, including product safety and environmental measures typically found in end products that incorporate such semiconductor components or circuit boards. This evaluation board/kit does not fall within the scope of the European Union directives regarding electromagnetic compatibility, restricted substances (RoHS), recycling (WEEE), FCC, CE or UL, and therefore may not meet the technical requirements of these directives or other related directives.

Should this evaluation board/kit not meet the specifications indicated in the User's Guide, the board/kit may be returned within 30 days from the date of delivery for a full refund. **THE FOREGOING WARRANTY IS THE EXCLUSIVE WARRANTY MADE BY SELLER TO BUYER AND IS IN LIEU OF ALL OTHER WARRANTIES, EXPRESSED, IMPLIED, OR STATUTORY, INCLUDING ANY WARRANTY OF MERCHANTABILITY OR FITNESS FOR ANY PARTICULAR PURPOSE.**

The user assumes all responsibility and liability for proper and safe handling of the goods. Further, the user indemnifies TI from all claims arising from the handling or use of the goods. Due to the open construction of the product, it is the user's responsibility to take any and all appropriate precautions with regard to electrostatic discharge.

EXCEPT TO THE EXTENT OF THE INDEMNITY SET FORTH ABOVE, NEITHER PARTY SHALL BE LIABLE TO THE OTHER FOR ANY INDIRECT, SPECIAL, INCIDENTAL, OR CONSEQUENTIAL DAMAGES.

TI currently deals with a variety of customers for products, and therefore our arrangement with the user **is not exclusive.**

TI assumes **no liability for applications assistance, customer product design, software performance, or infringement of patents or services described herein.**

Please read the User's Guide and, specifically, the Warnings and Restrictions notice in the User's Guide prior to handling the product. This notice contains important safety information about temperatures and voltages. For additional information on TI's environmental and/or safety programs, please contact the TI application engineer or visit www.ti.com/esh.

No license is granted under any patent right or other intellectual property right of TI covering or relating to any machine, process, or combination in which such TI products or services might be or are used.

FCC Warning

This evaluation board/kit is intended for use for **ENGINEERING DEVELOPMENT, DEMONSTRATION, OR EVALUATION PURPOSES ONLY** and is not considered by TI to be a finished end-product fit for general consumer use. It generates, uses, and can radiate radio frequency energy and has not been tested for compliance with the limits of computing devices pursuant to part 15 of FCC rules, which are designed to provide reasonable protection against radio frequency interference. Operation of this equipment in other environments may cause interference with radio communications, in which case the user at his own expense will be required to take whatever measures may be required to correct this interference.

EVM Warnings and Restrictions

It is important to operate this EVM within the input voltage range of 5V to 24V and the output voltage range of VIN to 17.4V .

Exceeding the specified input range may cause unexpected operation and/or irreversible damage to the EVM. If there are questions concerning the input range, please contact a TI field representative prior to connecting the input power.

Applying loads outside of the specified output range may result in unintended operation and/or possible permanent damage to the EVM. Please consult the EVM User's Guide prior to connecting any load to the EVM output. If there is uncertainty as to the load specification, please contact a TI field representative.

During normal operation, some circuit components may have case temperatures greater than 25°C. The EVM is designed to operate properly with certain components above 25°C as long as the input and output ranges are maintained. These components include but are not limited to linear regulators, switching transistors, pass transistors, and current sense resistors. These types of devices can be identified using the EVM schematic located in the EVM User's Guide. When placing measurement probes near these devices during operation, please be aware that these devices may be very warm to the touch.

Mailing Address: Texas Instruments, Post Office Box 655303, Dallas, Texas 75265
Copyright © 2011, Texas Instruments Incorporated

IMPORTANT NOTICE

Texas Instruments Incorporated and its subsidiaries (TI) reserve the right to make corrections, modifications, enhancements, improvements, and other changes to its products and services at any time and to discontinue any product or service without notice. Customers should obtain the latest relevant information before placing orders and should verify that such information is current and complete. All products are sold subject to TI's terms and conditions of sale supplied at the time of order acknowledgment.

TI warrants performance of its hardware products to the specifications applicable at the time of sale in accordance with TI's standard warranty. Testing and other quality control techniques are used to the extent TI deems necessary to support this warranty. Except where mandated by government requirements, testing of all parameters of each product is not necessarily performed.

TI assumes no liability for applications assistance or customer product design. Customers are responsible for their products and applications using TI components. To minimize the risks associated with customer products and applications, customers should provide adequate design and operating safeguards.

TI does not warrant or represent that any license, either express or implied, is granted under any TI patent right, copyright, mask work right, or other TI intellectual property right relating to any combination, machine, or process in which TI products or services are used. Information published by TI regarding third-party products or services does not constitute a license from TI to use such products or services or a warranty or endorsement thereof. Use of such information may require a license from a third party under the patents or other intellectual property of the third party, or a license from TI under the patents or other intellectual property of TI.

Reproduction of TI information in TI data books or data sheets is permissible only if reproduction is without alteration and is accompanied by all associated warranties, conditions, limitations, and notices. Reproduction of this information with alteration is an unfair and deceptive business practice. TI is not responsible or liable for such altered documentation. Information of third parties may be subject to additional restrictions.

Resale of TI products or services with statements different from or beyond the parameters stated by TI for that product or service voids all express and any implied warranties for the associated TI product or service and is an unfair and deceptive business practice. TI is not responsible or liable for any such statements.

TI products are not authorized for use in safety-critical applications (such as life support) where a failure of the TI product would reasonably be expected to cause severe personal injury or death, unless officers of the parties have executed an agreement specifically governing such use. Buyers represent that they have all necessary expertise in the safety and regulatory ramifications of their applications, and acknowledge and agree that they are solely responsible for all legal, regulatory and safety-related requirements concerning their products and any use of TI products in such safety-critical applications, notwithstanding any applications-related information or support that may be provided by TI. Further, Buyers must fully indemnify TI and its representatives against any damages arising out of the use of TI products in such safety-critical applications.

TI products are neither designed nor intended for use in military/aerospace applications or environments unless the TI products are specifically designated by TI as military-grade or "enhanced plastic." Only products designated by TI as military-grade meet military specifications. Buyers acknowledge and agree that any such use of TI products which TI has not designated as military-grade is solely at the Buyer's risk, and that they are solely responsible for compliance with all legal and regulatory requirements in connection with such use.

TI products are neither designed nor intended for use in automotive applications or environments unless the specific TI products are designated by TI as compliant with ISO/TS 16949 requirements. Buyers acknowledge and agree that, if they use any non-designated products in automotive applications, TI will not be responsible for any failure to meet such requirements.

Following are URLs where you can obtain information on other Texas Instruments products and application solutions:

Products

Audio	www.ti.com/audio
Amplifiers	amplifier.ti.com
Data Converters	dataconverter.ti.com
DLP® Products	www.dlp.com
DSP	dsp.ti.com
Clocks and Timers	www.ti.com/clocks
Interface	interface.ti.com
Logic	logic.ti.com
Power Mgmt	power.ti.com
Microcontrollers	microcontroller.ti.com
RFID	www.ti-rfid.com
RF/IF and ZigBee® Solutions	www.ti.com/lprf

Applications

Communications and Telecom	www.ti.com/communications
Computers and Peripherals	www.ti.com/computers
Consumer Electronics	www.ti.com/consumer-apps
Energy and Lighting	www.ti.com/energy
Industrial	www.ti.com/industrial
Medical	www.ti.com/medical
Security	www.ti.com/security
Space, Avionics and Defense	www.ti.com/space-avionics-defense
Transportation and Automotive	www.ti.com/automotive
Video and Imaging	www.ti.com/video
Wireless	www.ti.com/wireless-apps

TI E2E Community Home Page

e2e.ti.com

Mailing Address: Texas Instruments, Post Office Box 655303, Dallas, Texas 75265
Copyright © 2011, Texas Instruments Incorporated