

LM117HVQML-SP Total Ionizing Dose (TID) Radiation Report



ABSTRACT

This report discusses the results of the total ionizing dose (TID) testing for LM117HVQML-SP, radiation-hardened QMLV, 4.2-V to 60-V input, 500-mA adjustable output linear regulator. The study was done to determine TID effects under low dose rate (LDR) and high dose rate (HDR) up to 100 krad(Si). The results show that all samples passed within the specified limits up to 100 krad(Si).

Table of Contents

1 Device Information	2
1.1 Product Description.....	2
1.2 Device Details.....	2
2 Total Dose Test Setup	3
2.1 Test Overview.....	3
2.2 Test Description and Facilities.....	3
2.3 Test Setup Details.....	4
2.4 Test Configuration and Conditions.....	5
3 TI Characterization Test Results	6
3.1 Results Summary.....	6
3.2 Test Results.....	6
3.3 Conclusion.....	6
3.4 Data Sheet Electrical Parameters and Associated Tests.....	6
4 Applicable and Reference Documents	8
4.1 Applicable Documents.....	8
4.2 Reference Documents.....	8
A Appendix: HDR and LDR TID Report Data	9

List of Figures

Figure 1-1. LM117HVQML-SP Device Photo (Front and Back).....	2
Figure 2-1. Bias Diagram Used in TID Exposure.....	4

List of Tables

Table 1-1. Device and Exposure Details.....	2
Table 2-1. HDR \geq 3 krad(Si) to 100 krad(Si) Biased Device Serial Numbers.....	5
Table 2-2. HDR \geq 3 krad(Si) to 100 krad(Si) Unbiased Device Serial Numbers.....	5
Table 2-3. LDR \geq 3 krad(Si) to 100 krad(Si) Biased Device Serial Numbers.....	5
Table 2-4. LDR \geq 3 krad(Si) to 100 krad(Si) Unbiased Device Serial Numbers.....	5
Table 3-1. LM117HVQML-SP Electrical Parameters Table.....	6

Trademarks

All trademarks are the property of their respective owners.

1 Device Information

1.1 Product Description

The LM117HVQML-SP is an adjustable 3-terminal positive voltage linear regulator that is capable of supplying 0.5 A over a 1.2-V to 57-V output range. It is simple to use and requires only two external resistors to set the output voltage.

The regulator is "floating" and sees only the input-to output differential voltage, thus enabling supplies of several hundred volts to be regulated as long as the maximum input-to-output differential is not exceeded

1.2 Device Details

[Table 1-1](#) lists the device information used in the initial TID HDR and LDR characterization.

Table 1-1. Device and Exposure Details

TID Exposure Details	
TI Device	LM117HVHRLQMLV
TI Part Name	5962R0722961VXA
Package	3-pin CFP (NDT)
Technology	SLM
Quantity Tested	HDR - 180, LDR - 78
Lot Accept/Reject	All levels tested and passed up to 100 krad(Si) for HDR and LDR
HDR Radiation Facility	National Semiconductor, South Portland, Maine
HDR Dose Level	3 krad(Si), 10 krad(Si), 30 krad(Si), 50 krad(Si), 100 krad(Si)
HDR Dose Rate	34-39 rad(Si)/s
LDR Radiation Facility	White Sands Missile Range, New Mexico
LDR Dose Level	3 krad(Si), 10 krad(Si), 30 krad(Si), 50 krad(Si), 100 krad(Si)
LDR Dose Rate	0.01 rad(Si)/s
Irradiation Temperature	Ambient, room temperature



Figure 1-1. LM117HVQML-SP Device Photo (Front and Back)

2 Total Dose Test Setup

2.1 Test Overview

This characterization was performed using MIL-STD-883G, test method 1019.7, section 3.13.1.1 as a guide. The test procedure was modified to increase the sample size to 3 different wafers, with 6 units per wafer for high dose rate testing (for a total of 18 units per high dose rate leg) and 5 units per wafer for low dose rate testing (for a total of 15 units per low dose rate leg).

Low dose rate, units biased during radiation

Low dose rate, units unbiased during radiation

High dose rate, units biased during radiation

High dose rate, units unbiased during radiation

The product was irradiated up to the target radiation level, and then put through full electrical parametric testing on the production Automated Test Equipment (ATE). All devices remained functional passing all parametric test limits.

The test units, along with control units were tested before radiation. They were split into the four test legs and sent through irradiation, according to 1019.7. The units were pulled out at various time points and retested. See attached tables for test points.

Wafer lot number: JZ069X25

Wafer and assembly lot numbers:

1: 7D5805L019

3: 7D5806J019

5: 7D5892A019

Radiation board: 8784HR

Test program: RH00117HYD

5962R0722961VXA devices were irradiated for this report. The below table details which sections of this report are applicable for other space grade versions of the LM117HV.

TI Part Number	SMD	Applicable Portions of TID Report
LM117HVHRLQMLV	5962R0722961VXA	LDR + HDR
LM117HVHRQMLV	5962R0722901VXA	HDR
LM117HVWGRQMLV	5962R0722962VZA	LDR + HDR
LM117HVWGRQMLV	5962R0722902VZA	HDR
LM117HVH MDE	5962R0722961V9A	LDR + HDR
LM117HVH MDR	5962R0722901V9A	HDR

2.2 Test Description and Facilities

The LM117HRLQMLV HDR exposure was performed on biased and unbiased devices at TI facility in South Portland, Maine. The dose rate for this testing was between 34-39 rad(Si)/s. After exposure, the devices underwent a full post-radiation electrical testing in South Portland, Maine.

The LM117HRLQMLV LDR exposure was performed on biased and unbiased devices in White Sands Missile Range in New Mexico. The dose rate of the irradiator used in the exposure was 10 mrad(Si)/s. After exposure, devices were electrically tested at Texas Instruments in South Portland, Maine. The test program consists of guard band test limits set within data sheet electrical test limits.

2.3 Test Setup Details

The devices under HDR and LDR exposure were tested in two conditions, biased and unbiased, as described in the following sections.

2.3.1 Unbiased

For the unbiased HDR and LDR conditions, the exposure was performed with all pins grounded.

2.3.2 Biased

Figure 2-1 shows the diagram for HDR and LDR exposure with biased condition.

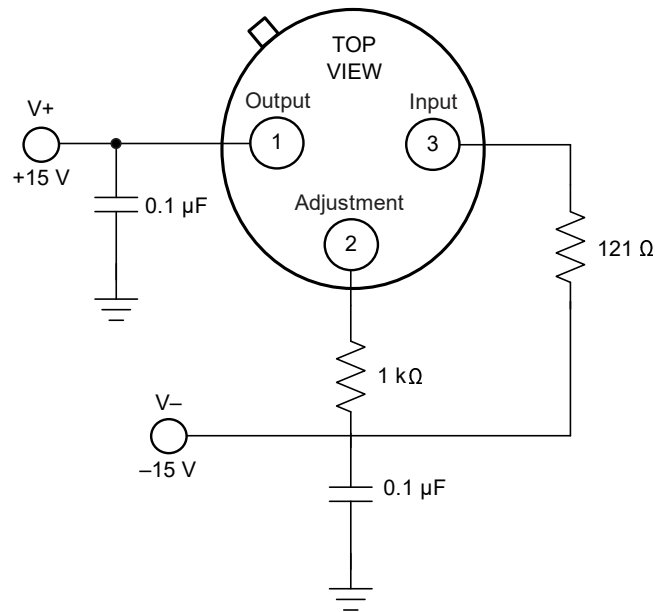

Figure 2-1. Bias Diagram Used in TID Exposure

2.4 Test Configuration and Conditions

HDR devices were stressed at 3 krad(Si), 10 krad(Si), 30 krad(Si), 50 krad(Si), and 100 krad(Si) for biased and unbiased conditions.

LDR devices were stressed at 3 krad(Si), 10 krad(Si), 30 krad(Si), 50 krad(Si), and 100 krad(Si) for biased and unbiased conditions.

Table 2-1. HDR ≥ 3 krad(Si) to 100 krad(Si) Biased Device Serial Numbers

Total Samples: 90				
Exposure Levels				
3 krad(Si)	10krad(Si)	30 krad(Si)	50 krad(Si)	100 krad(Si)
Wafer 1: 3, 4, 5, 6, 7, 8 Wafer 3: 3, 4, 5, 6, 7, 8 Wafer 5: 31, 32, 33, 34, 35, 36	Wafer 1: 3, 4, 5, 6, 7, 8 Wafer 3: 3, 4, 5, 6, 7, 8 Wafer 5: 31, 32, 33, 34, 35, 36	Wafer 1: 3, 4, 5, 6, 7, 8 Wafer 3: 3, 4, 5, 6, 7, 8 Wafer 5: 31, 32, 33, 34, 35, 36	Wafer 1: 3, 4, 5, 6, 7, 8 Wafer 3: 3, 4, 5, 6, 7, 8 Wafer 5: 31, 32, 33, 34, 35, 36	Wafer 1: 3, 4, 5, 6, 7, 8 Wafer 3: 3, 4, 5, 6, 7, 8 Wafer 5: 31, 32, 33, 34, 35, 36

Table 2-2. HDR ≥ 3 krad(Si) to 100 krad(Si) Unbiased Device Serial Numbers

Total Samples: 90				
Exposure Levels				
3 krad(Si)	10krad(Si)	30 krad(Si)	50 krad(Si)	100 krad(Si)
Wafer 1: 15, 16, 17, 18, 19, 20 Wafer 3: 15, 16, 17, 18, 19, 20 Wafer 5: 9, 10, 11, 12, 13, 14	Wafer 1: 15, 16, 17, 18, 19, 20 Wafer 3: 15, 16, 17, 18, 19, 20 Wafer 5: 9, 10, 11, 12, 13, 14	Wafer 1: 15, 16, 17, 18, 19, 20 Wafer 3: 15, 16, 17, 18, 19, 20 Wafer 5: 9, 10, 11, 12, 13, 14	Wafer 1: 15, 16, 17, 18, 19, 20 Wafer 3: 15, 16, 17, 18, 19, 20 Wafer 5: 9, 10, 11, 12, 13, 14	Wafer 1: 15, 16, 17, 18, 19, 20 Wafer 3: 15, 16, 17, 18, 19, 20 Wafer 5: 9, 10, 11, 12, 13, 14

Table 2-3. LDR ≥ 3 krad(Si) to 100 krad(Si) Biased Device Serial Numbers

Total Samples: 48				
Exposure Levels				
3 krad(Si)	10krad(Si)	30 krad(Si)	50 krad(Si)	100 krad(Si)
Wafer 1: 15, 16, 17, 18, 21 Wafer 3: 51, 52, 53, 54, 55 Wafer 5: 21, 22, 23, 24, 25	Wafer 1: 15, 16, 17, 18, 21 Wafer 3: 51, 52, 53, 54, 55 Wafer 5: 21, 22, 23, 24, 25	Wafer 1: 15, 16, 17, 18, 21 Wafer 3: 51, 52, 53, 54, 55 Wafer 5: 21, 22, 23, 24, 25	Wafer 1: 15, 16, 17, 18, 21 Wafer 3: 51, 52, 53, 54, 55 Wafer 5: 21, 22, 23, 24, 25	Wafer 1: 15, 16, 17, 18, 21 Wafer 3: 51, 52, 53, 54, 55 Wafer 5: 21, 22, 23, 24, 25

Table 2-4. LDR ≥ 3 krad(Si) to 100 krad(Si) Unbiased Device Serial Numbers

Total Samples: 30				
Exposure Levels				
3 krad(Si)	10krad(Si)	30 krad(Si)	50 krad(Si)	100 krad(Si)
Wafer 1: 20, 22, 23, 24, 25 Wafer 3: 56, 57, 58, 59, 60 Wafer 5: 26, 27, 28, 29, 30	Wafer 1: 20, 22, 23, 24, 25 Wafer 3: 56, 57, 58, 59, 60 Wafer 5: 26, 27, 28, 29, 30	Wafer 1: 20, 22, 23, 24, 25 Wafer 3: 56, 57, 58, 59, 60 Wafer 5: 26, 27, 28, 29, 30	Wafer 1: 20, 22, 23, 24, 25 Wafer 3: 56, 57, 58, 59, 60 Wafer 5: 26, 27, 28, 29, 30	Wafer 1: 20, 22, 23, 24, 25 Wafer 3: 56, 57, 58, 59, 60 Wafer 5: 26, 27, 28, 29, 30

3 TI Characterization Test Results

3.1 Results Summary

A summary of the results is presented in the following tables and graphs. For each parametric test, the number of units tested (OBS), the average reading (AVG), median (MEDIAN), minimum and maximum readings (MIN, MAX) and standard deviation (SIGMA) are shown for each test leg at the various radiation test points. The upper and lower datasheet limits (UTL, LTL) are listed with the pre-irradiation limits shown at the 0 rad level, and the post 100 krad irradiation limits shown at each of the radiation levels. The delta column (Median Delta (from 0 rad)) shows the difference of the parametric reading between the radiation level tested and the pre-irradiation level for the median value. The ratio column (Delta Ratio to HDR) is the ratio of the median delta for the low dose rate and high dose rate for the bias conditions. The final column (Max Unit Delta) shows the highest drift seen on any one unit for all samples tested. The legs as listed are:

LDR_bias: Low dose rate, units biased during radiation

LDR_unbias: Low dose rate, units unbiased during radiation

HDR_bias: Standard dose rate, units biased during radiation

HDR_unbias: Standard dose rate, units unbiased during radiation

On the same page as the table, a graph showing the average readings for each leg, along with the upper and lower spec limits is included. The page following each table shows graphs of the 4 legs with maximum, minimum and average readings. All graphs show the datasheet limits, with the pre-irradiation limits at the 0 point, and the post 100 krad irradiation limits for the rest of the graph.

3.2 Test Results

For high dose rate (HDR) testing, the only parameter to show a significant drift (greater than 10% of the spec range) through 100 krad of total ionizing dose (TID) was ripple rejection (test 10100).

At low dose rate (LDR), nearly every parameter showed a higher drift than under the HDR conditions. The worst case was LDR with the units unbiased. For some of the parameters, the ratio of the median deltas between 0 krad and 100 krad for the LDR results and the HDR results is greater than 1.5, and the post irradiation readings are outside the pre irradiation limits, the criteria suggested by MIL-STD-883G, Test Method 1019.7, section 3.13.1 for products to be considered “ELDRS susceptible”.

For all parameters, under all test conditions, the 100 krad(Si) results remained within the post irradiation limits.

See [Table 3-1](#) for Data Sheet Electrical Parameters and Associated Tests.

See [Appendix A](#) for HDR and LDR report up to 100 krad(Si).

3.3 Conclusion

Under strict interpretation of the MIL-STD-883G, Test Method 1019.7, some parameters on the LM117HVxRLQMLV could be considered as being “ELDRS susceptible”. However, the product fully passes all datasheet and SMD post irradiation limits at 100 krad(Si) under both HDR and LDR conditions.

These products have been released as a part of TI's (previously National's) “Low Dose Rate Qualified” product family that is tested and qualified at LDR, and pass all limits in the datasheet and SMD, but may have some parameters that could be considered ELDRS susceptible.

3.4 Data Sheet Electrical Parameters and Associated Tests

Table 3-1. LM117HVQML-SP Electrical Parameters Table

PARAMETER	TEST CONDITION	LM117HVQML-SP DATA SHEET (SNVSC25)			TEST#
		MIN	MAX	UNIT	
Adjust Pin Current	V _{DIFF} = 3V, 25°C		100	µA	100.0
	V _{DIFF} = 40V		100		200.0

Table 3-1. LM117HVQML-SP Electrical Parameters Table (continued)

PARAMETER	TEST CONDITION		LM117HVQML-SP DATA SHEET (SNVSC25)			TEST#
			MIN	MAX	UNIT	
Adjust pin current change	$3V \leq V_{DIFF} \leq 40V, 25^{\circ}C$		-5	5	μA	300.0
Adjust pin current change	$V_{DIFF} = 3V, 10mA \leq I_L \leq 500mA, 25^{\circ}C$		-5	5	μA	400.0
	$V_{DIFF} = 40V, 10mA \leq I_L \leq 150mA, 25^{\circ}C$		-5	5		500.0
Minimum load current	$V_{DIFF} = 3V, V_O = 1.7V, 25^{\circ}C$			5	mA	600.0
	$V_{DIFF} = 40V, V_O = 1.7V$			5		700.0
	$V_{DIFF} = 60V, V_O = 1.7V, 25^{\circ}C$			8.2		800.0
Reference Voltage	$V_{DIFF} = 3V$		1.2	1.3	V	900.0
		25°C Post radiation	1.2	1.45		
	$V_{DIFF} = 40V$		1.2	1.3		1000.0
		25°C Post radiation	1.2	1.45		
Line Regulation	$3V \leq V_{DIFF} \leq 40V, V_O = V_{REF}$	25°C	-8.64	8.64	mV	1100.0
		25°C Post radiation	-40	40		
	$40V \leq V_{DIFF} \leq 60V, V_O = V_{REF}, 25^{\circ}C$		-25	25		1200.0
Load Regulation	$V_{DIFF} = 3V, 10mA \leq I_L \leq 500mA$	25°C	-15	15	mV	1300.0
		25°C Post radiation	-27	27		
	$V_{DIFF} = 40V, 10mA \leq I_L \leq 150mA, 25^{\circ}C$		-15	15		1400.0
Thermal Regulation	$V_{DIFF} = 40V, I_L = 150mA, t = 20ms$			6	mV	1500.0
Output Short Circuit Current	$V_I = 4.25V$		0.5	1.8	A	1600.0
	$V_I = 60V$		0	0.4		1700.0
Ripple Rejection	$V_I = 6.25V, I_L = 125mA, e_i = 1V_{RMS}, f = 120Hz$	25°C	66		dB	10100.0
		25°C Post radiation	55			

4 Applicable and Reference Documents

4.1 Applicable Documents

- Texas Instruments, [LM117HVQML-SP RHA 4.25-V to 60-V 3-Terminal Adjustable Regulator data sheet](#)
- Texas Instruments, [LM117HVQML-SP Neutron Displacement Damage \(NDD\) Characterization](#)

4.2 Reference Documents

Texas Instruments total ionizing dose radiation (total dose) test procedure utilizes the standards put forth in MIL-STD-883 TM 1019. The document can be found at the DLA website.

A Appendix: HDR and LDR TID Report Data

This appendix contains the HDR TID report data.

LM117HVHRLQMLV Radiation Data

LM117HVHRLQMLV Radiation Data

TEST ID 100 - IADJ; VDIFF=3V, V_{IN} = 4.25 V (UA)

TEST_BIAS	DOSE (k)	OBS	AVG	MEDIAN	MAX	MIN	SIGMA	UTL	LTL	Median Delta (from 0 rad)	Delta Ratio (to HDR)	Max Unit Delta
LDR_bias	0	15	36.3437	36.3134	36.7751	35.5244	0.334862	100	2	0		
LDR_bias	3	15	36.2523	36.19	36.6088	35.5506	0.333564	100	2	-0.1234		
LDR_bias	10	15	36.3112	36.2943	36.7229	35.6686	0.350527	100	2	-0.0191		
LDR_bias	30	15	36.6086	36.6183	37.0145	36.0743	0.271857	100	2	0.3049		
LDR_bias	50	15	36.3444	36.2939	36.8032	35.7039	0.348741	100	2	-0.0195		
LDR_bias	80	15	36.03	35.9931	36.4035	35.3993	0.338529	100	2	-0.3203		
LDR_bias	100	15	35.8313	35.8443	36.2369	35.1209	0.371144	100	2	-0.4691	3.13	
LDR_unbias	0	15	36.4055	36.3754	36.8466	35.9861	0.22103	100	2	0		
LDR_unbias	3	15	36.366	36.2765	36.9	35.9315	0.250397	100	2	-0.0989		
LDR_unbias	10	15	36.6157	36.5909	37.0335	36.3563	0.195805	100	2	0.2155		
LDR_unbias	30	15	37.1297	37.0738	37.6509	36.424	0.352953	100	2	0.6984		
LDR_unbias	50	15	37.8893	37.854	38.4708	37.459	0.305621	100	2	1.4786		
LDR_unbias	80	15	38.5032	38.5113	39.0445	38.054	0.292731	100	2	2.1359		
LDR_unbias	100	15	38.6574	38.5876	39.2157	38.0647	0.321327	100	2	2.2122	3.04	
HDR_bias	0	18	36.433	36.4527	36.8711	35.9585	0.224741	100	2	0		
HDR_bias	3	18	36.6447	36.6339	36.8902	36.4569	0.138689	100	2	0.1812		
HDR_bias	10	18	36.5916	36.5582	36.8807	36.1942	0.173799	100	2	0.1055		
HDR_bias	30	18	36.5156	36.5486	36.9009	36.106	0.187091	100	2	0.0959		
HDR_bias	50	18	36.4629	36.5195	36.9188	35.8348	0.25042	100	2	0.0668		
HDR_bias	80	18	36.4149	36.4867	36.9057	35.5955	0.341055	100	2	0.034		
HDR_bias	100	18	36.2373	36.303	36.7913	35.3123	0.370034	100	2	-0.1497		
HDR_unbias	0	15	36.3909	36.3606	36.6974	36.118	0.171804	100	2	0		
HDR_unbias	3	15	36.4265	36.4369	36.7105	36.143	0.167753	100	2	0.0763		
HDR_unbias	10	15	36.5056	36.4748	36.7701	36.2536	0.159884	100	2	0.1142		
HDR_unbias	30	15	36.4618	36.445	36.8032	36.1454	0.182348	100	2	0.0844		
HDR_unbias	50	15	36.587	36.5511	36.9117	36.2464	0.172067	100	2	0.1905		
HDR_unbias	80	15	36.8502	36.8819	37.1126	36.5296	0.169897	100	2	0.5213		
HDR_unbias	100	15	37.0388	37.0891	37.2638	36.6452	0.184081	100	2	0.7285		

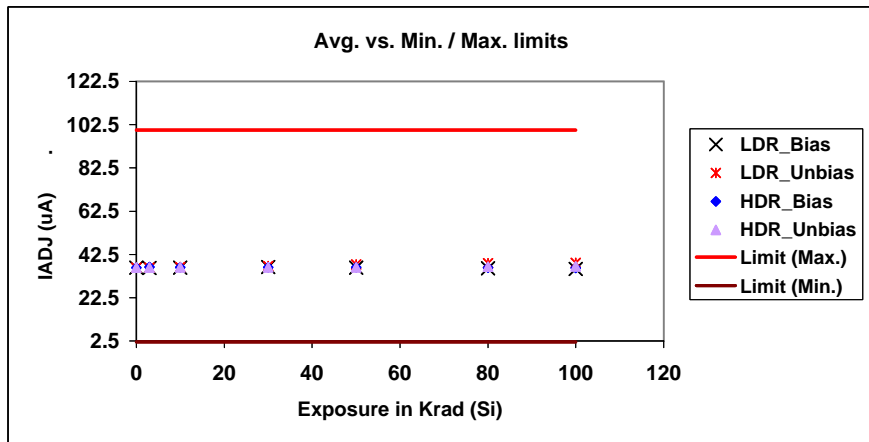

LM117HVHRLQMLV Radiation Data

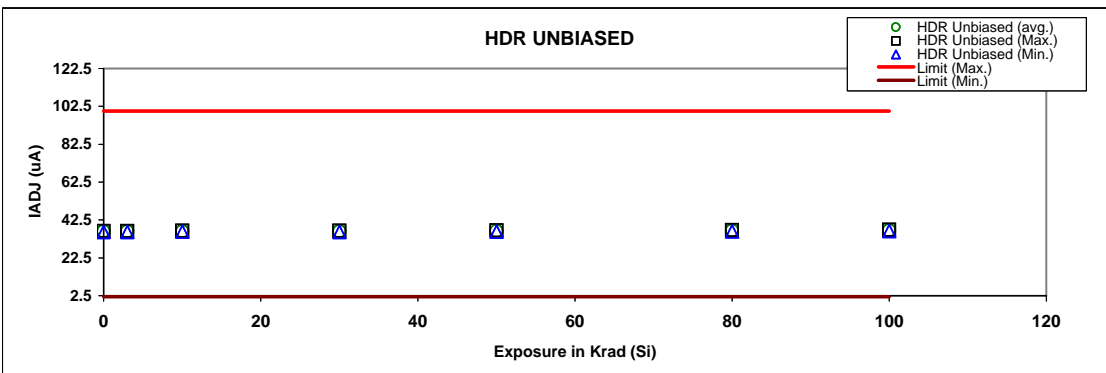
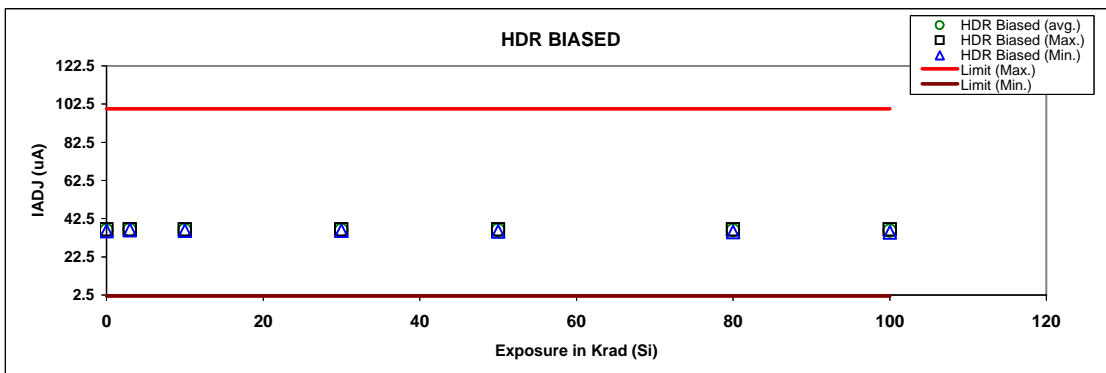
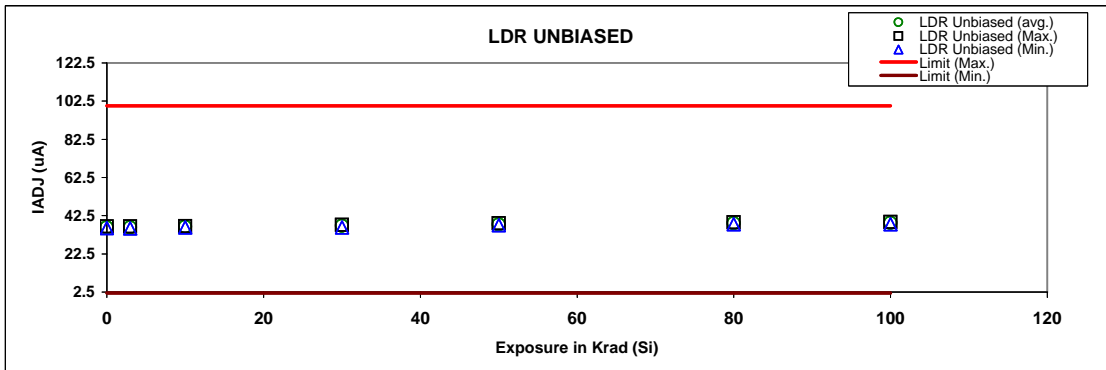
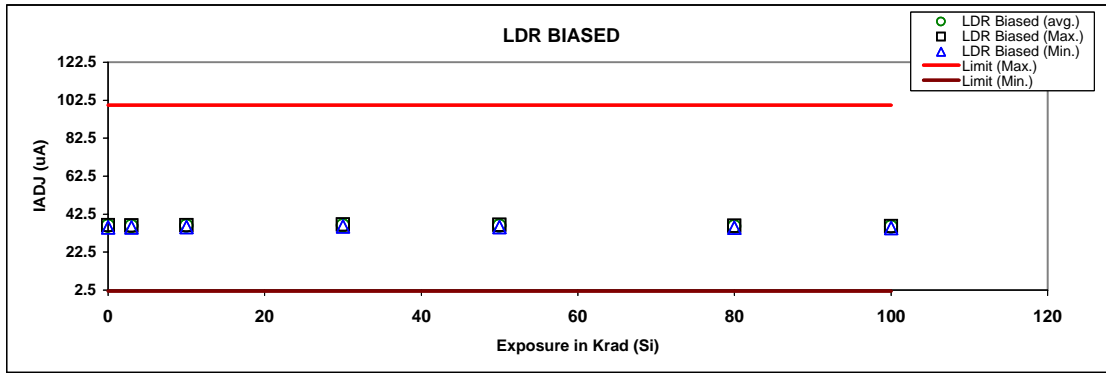

LM117HVHRLQMLV Radiation Data

TEST ID 200 - IADJ; VDIFF=40V, V_{IN} = 41.25 V (UA)

TEST_BIAS	DOSE (k)	OBS	AVG	MEDIAN	MAX	MIN	SIGMA	UTL	LTL	Median Delta (from 0 rad)	Delta Ratio (to HDR)	Max Unit Delta
LDR_bias	0	15	36.5938	36.5444	36.9429	35.9518	0.271205	100	2	0		
LDR_bias	3	15	36.5044	36.4383	36.8192	35.891	0.288513	100	2	-0.1061		
LDR_bias	10	15	36.5953	36.5956	36.9787	36.0195	0.322309	100	2	0.0512		
LDR_bias	30	15	36.9243	36.9417	37.3405	36.4324	0.242326	100	2	0.3973		
LDR_bias	50	15	36.7208	36.6655	37.1544	36.0846	0.345362	100	2	0.1211		
LDR_bias	80	15	36.4087	36.3654	36.8271	35.8181	0.344892	100	2	-0.179		
LDR_bias	100	15	36.1984	36.1835	36.6071	35.498	0.374473	100	2	-0.3609	-11.24	
LDR_unbias	0	15	36.6014	36.5575	37.0383	36.1614	0.209426	100	2	0		
LDR_unbias	3	15	36.5914	36.4765	37.4392	36.1387	0.31224	100	2	-0.081		
LDR_unbias	10	15	36.8952	36.9038	37.3906	36.6004	0.219462	100	2	0.3463		
LDR_unbias	30	15	37.5176	37.4225	38.3683	36.7134	0.42139	100	2	0.865		
LDR_unbias	50	15	38.4894	38.435	39.1396	37.9839	0.360869	100	2	1.8775		
LDR_unbias	80	15	39.289	39.2145	39.8964	38.8147	0.320358	100	2	2.657		
LDR_unbias	100	15	39.5371	39.3775	40.2202	39.0326	0.357885	100	2	2.82	2.81	
HDR_bias	0	18	36.6151	36.6374	37.0616	36.1394	0.228881	100	2	0		
HDR_bias	3	18	36.842	36.8437	37.0995	36.6512	0.134685	100	2	0.2063		
HDR_bias	10	18	36.7851	36.7629	37.0911	36.3594	0.177108	100	2	0.1255		
HDR_bias	30	18	36.7617	36.7859	37.1579	36.357	0.185425	100	2	0.1485		
HDR_bias	50	18	36.7377	36.7955	37.2339	36.0953	0.256663	100	2	0.1581		
HDR_bias	80	18	36.7534	36.82	37.2816	35.8729	0.354621	100	2	0.1826		
HDR_bias	100	18	36.6052	36.6695	37.1755	35.6574	0.391333	100	2	0.0321		
HDR_unbias	0	15	36.5695	36.5451	36.8819	36.2703	0.181046	100	2	0		
HDR_unbias	3	15	36.6154	36.6369	36.8986	36.3165	0.175645	100	2	0.0918		
HDR_unbias	10	15	36.6926	36.675	36.9496	36.4497	0.152671	100	2	0.1299		
HDR_unbias	30	15	36.7036	36.7034	37.07	36.3785	0.181708	100	2	0.1583		
HDR_unbias	50	15	36.9021	36.8855	37.2054	36.5606	0.168056	100	2	0.3404		
HDR_unbias	80	15	37.2486	37.2542	37.5114	36.8986	0.186267	100	2	0.7091		
HDR_unbias	100	15	37.4878	37.5493	37.7112	37.0545	0.202527	100	2	1.0042		

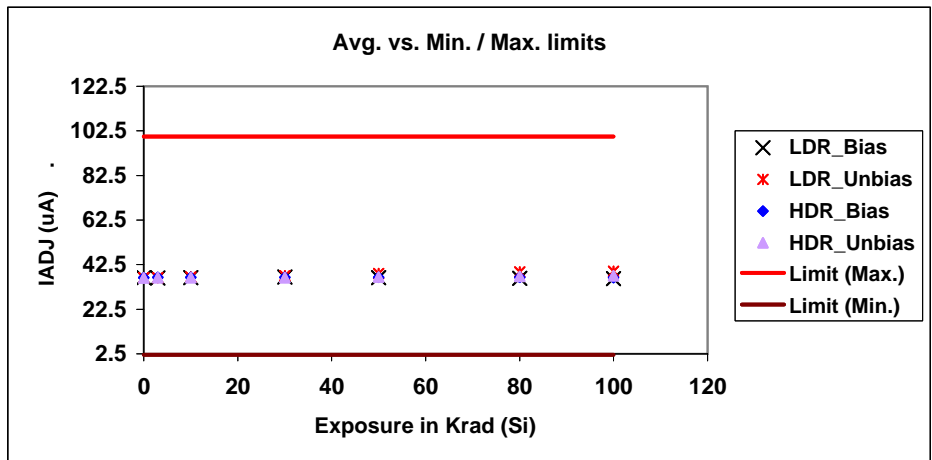

LM117HVHRLQMLV Radiation Data

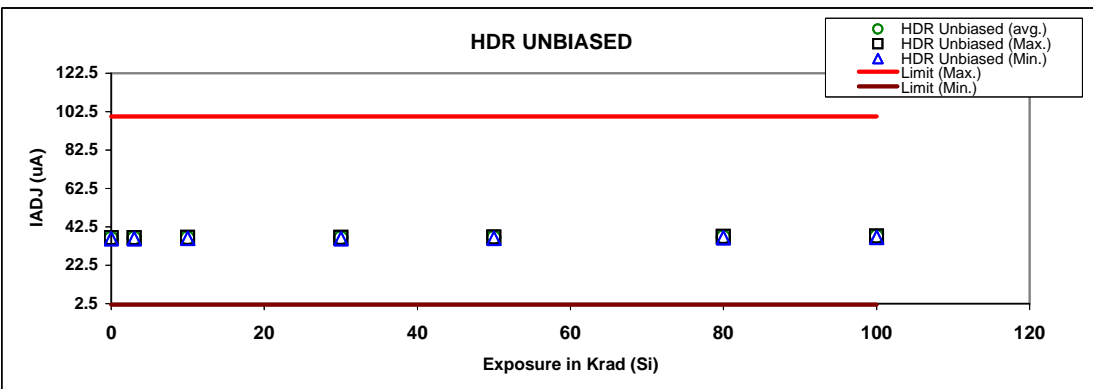
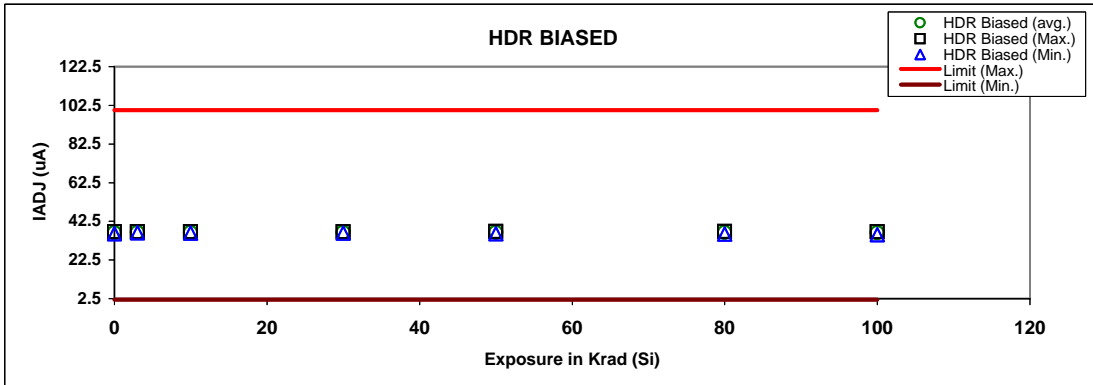
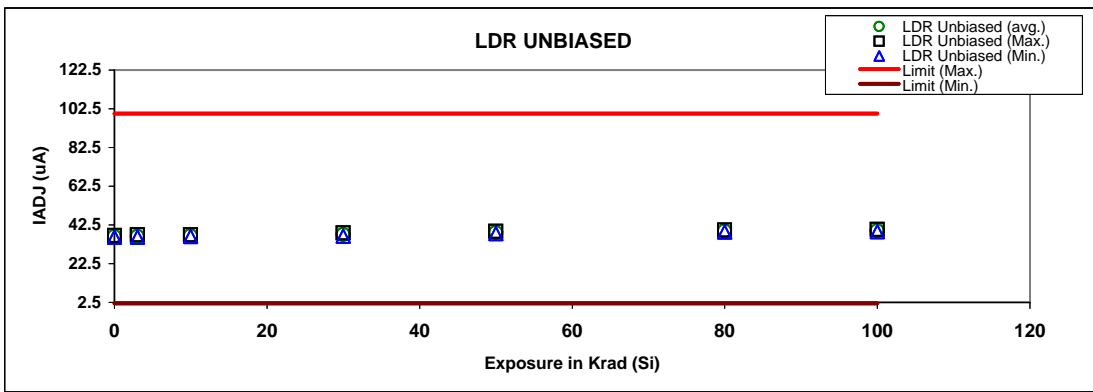
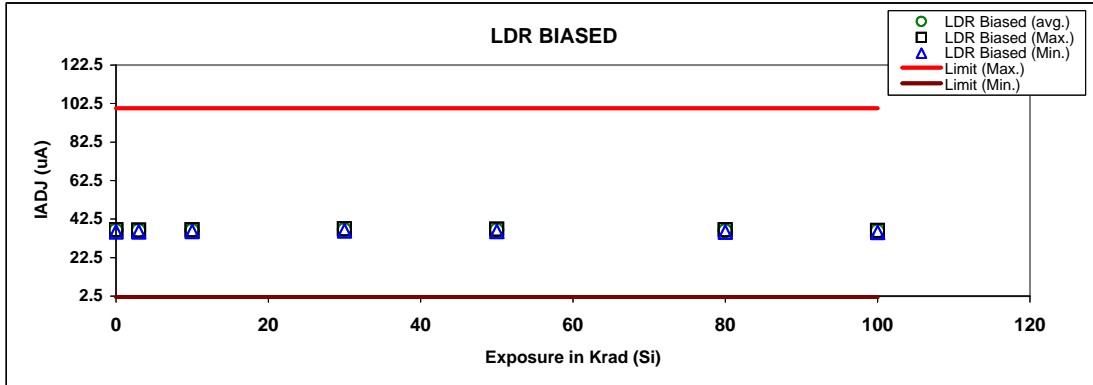

LM117HVHRLQMLV Radiation Data

TEST ID 300 - DELTA IADJ; 3V<=VDIFF<=40V, IL=8 MA (UA)

TEST_BIAS	DOSE (k)	OBS	AVG	MEDIAN	MAX	MIN	SIGMA	UTL	LTL	Median Delta (from 0 rad)	Delta Ratio (to HDR)	Max Unit Delta
LDR_bias	0	15	0.25014	0.19974	0.435495	0.161846	0.107152	5	-5	0		
LDR_bias	3	15	0.252117	0.223576	0.36422	0.190208	0.0591284	5	-5	0.023836		
LDR_bias	10	15	0.28404	0.279601	0.350861	0.219065	0.0405575	5	-5	0.079861		
LDR_bias	30	15	0.315734	0.30463	0.436688	0.230983	0.0512439	5	-5	0.10489		
LDR_bias	50	15	0.376427	0.380664	0.409273	0.325148	0.0225431	5	-5	0.180924		
LDR_bias	80	15	0.378716	0.375905	0.423577	0.331784	0.0280942	5	-5	0.176165		
LDR_bias	100	15	0.367115	0.371132	0.400934	0.337997	0.0222335	5	-5	0.171392	0.93	
LDR_unbias	0	15	0.195906	0.178537	0.422384	0.148735	0.0646122	5	-5	0		
LDR_unbias	3	15	0.225373	0.200933	0.573506	0.180924	0.0966557	5	-5	0.022396		
LDR_unbias	10	15	0.279429	0.274827	0.357075	0.228349	0.0338653	5	-5	0.09629		
LDR_unbias	30	15	0.387911	0.354703	0.717424	0.289379	0.100316	5	-5	0.176166		
LDR_unbias	50	15	0.600061	0.581073	0.898814	0.524102	0.0950459	5	-5	0.402536		
LDR_unbias	80	15	0.785877	0.755608	1.07616	0.694054	0.100111	5	-5	0.577071		
LDR_unbias	100	15	0.879738	0.831642	1.09285	0.765154	0.094797	5	-5	0.653105	2.35	
HDR_bias	0	18	0.182117	0.185202	0.228334	0.152315	0.0209323	5	-5	0		
HDR_bias	3	18	0.197328	0.194144	0.229527	0.167798	0.0174695	5	-5	0.008942		
HDR_bias	10	18	0.193543	0.199136	0.228334	0.0905711	0.0297351	5	-5	0.013934		
HDR_bias	30	18	0.246086	0.245614	0.269109	0.228334	0.0143343	5	-5	0.060412		
HDR_bias	50	18	0.274777	0.276006	0.315093	0.189	0.0299929	5	-5	0.090804		
HDR_bias	80	18	0.338486	0.342276	0.376138	0.277461	0.0280425	5	-5	0.157074		
HDR_bias	100	18	0.367886	0.368978	0.419037	0.304615	0.0322969	5	-5	0.183776		
HDR_unbias	0	15	0.178599	0.182103	0.247674	0.128726	0.0275802	5	-5	0		
HDR_unbias	3	15	0.188896	0.193089	0.225962	0.158529	0.0183537	5	-5	0.010986		
HDR_unbias	10	15	0.186977	0.186628	0.239335	0.0879518	0.0327496	5	-5	0.004525		
HDR_unbias	30	15	0.241723	0.242901	0.275089	0.19047	0.0199549	5	-5	0.060798		
HDR_unbias	50	15	0.315072	0.310582	0.380664	0.273882	0.0301802	5	-5	0.128479		
HDR_unbias	80	15	0.398367	0.412838	0.428336	0.351109	0.0274318	5	-5	0.230735		
HDR_unbias	100	15	0.44906	0.460263	0.494838	0.376152	0.0352961	5	-5	0.27816		

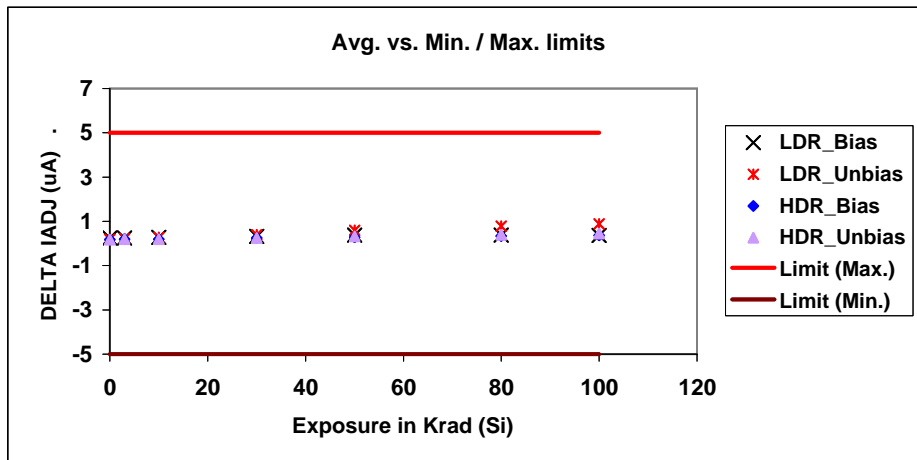

LM117HVHRLQMLV Radiation Data

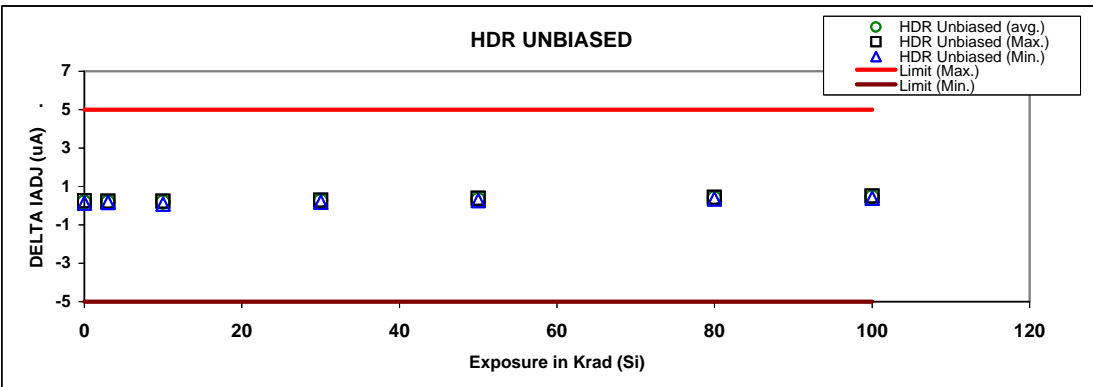
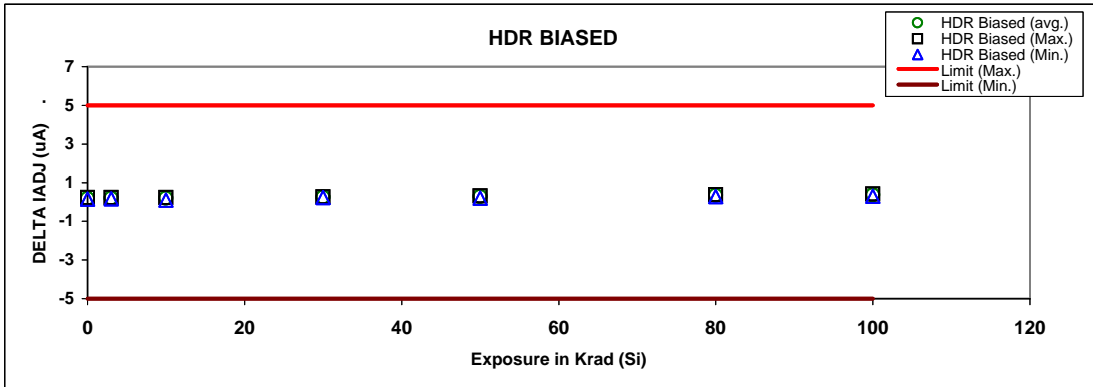
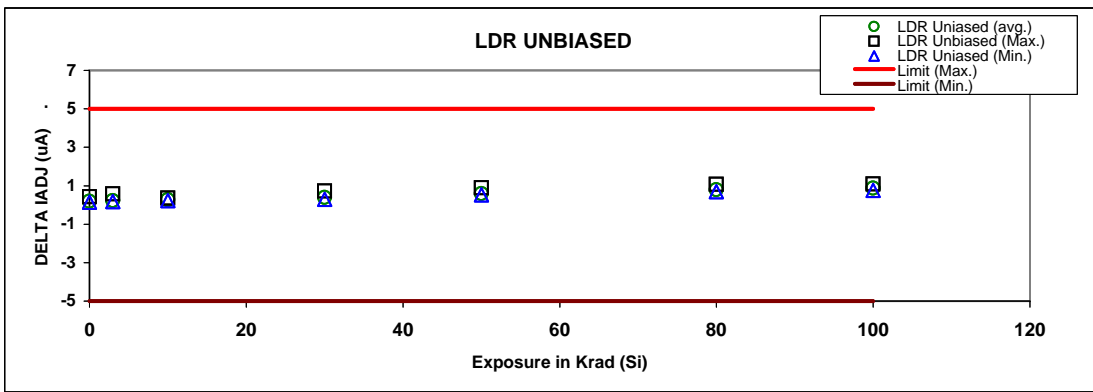
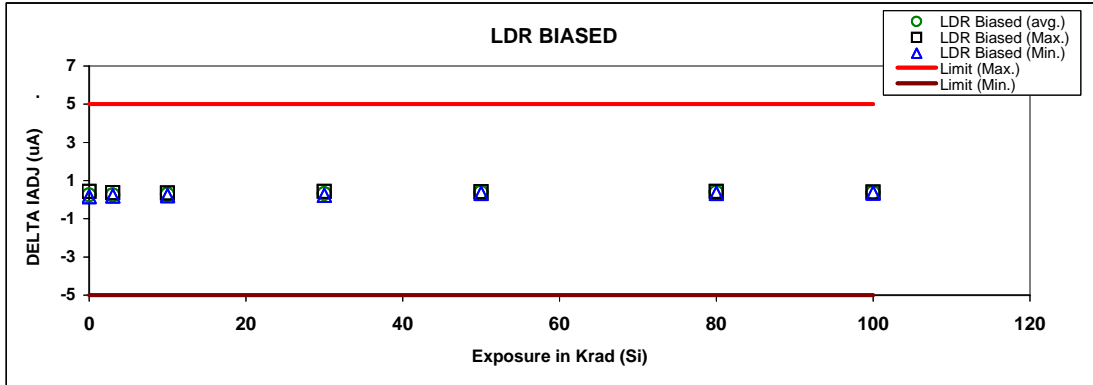

LM117HVHRLQMLV Radiation Data

TEST ID 400 - DELTA IADJ; VDIFF=3V, 10 MA<=IL<=500 MA (UA)

TEST_BIAS	DOSE (k)	OBS	AVG	MEDIAN	MAX	MIN	SIGMA	UTL	LTL	Median Delta (from 0 rad)	Delta Ratio (to HDR)	Max Unit Delta
LDR_bias	0	15	0.069757	0.0595901	0.120388	0.0178698	0.0314776	5	-5	0		
LDR_bias	3	15	0.0554768	0.0524451	0.0998698	-0.023836	0.0276865	5	-5	-0.007145		
LDR_bias	10	15	0.0712239	0.0667496	0.11774	0.0441069	0.01819	5	-5	0.0071595		
LDR_bias	30	15	0.0804566	0.0796135	0.104643	0.0560103	0.0162214	5	-5	0.0200234		
LDR_bias	50	15	0.0888938	0.0941654	0.109416	0.0700675	0.0130348	5	-5	0.0345753		
LDR_bias	80	15	0.098336	0.0939181	0.148735	0.0667496	0.0204931	5	-5	0.034328		
LDR_bias	100	15	0.0945186	0.0927248	0.126092	0.0750879	0.0127069	5	-5	0.0331347	0.64	
LDR_unbias	0	15	0.0581291	0.0500586	0.124899	0.0357541	0.0222096	5	-5	0		
LDR_unbias	3	15	0.0744311	0.0569562	0.170199	0.0426517	0.039187	5	-5	0.0068976		
LDR_unbias	10	15	0.0717652	0.0655564	0.114422	0.0453001	0.0191384	5	-5	0.0154978		
LDR_unbias	30	15	0.0956478	0.0879518	0.198546	0.0667496	0.0314218	5	-5	0.0378932		
LDR_unbias	50	15	0.155696	0.147542	0.250046	0.125146	0.0321769	5	-5	0.0974834		
LDR_unbias	80	15	0.223324	0.216838	0.284359	0.179891	0.0312403	5	-5	0.1667794		
LDR_unbias	100	15	0.236605	0.226384	0.299857	0.200002	0.0279955	5	-5	0.1763254	2.28	
HDR_bias	0	18	0.0476705	0.0488653	0.0762666	0.0190776	0.0135394	5	-5	0		
HDR_bias	3	18	0.0596839	0.0500513	0.176151	0.0357541	0.0308104	5	-5	0.001186		
HDR_bias	10	18	0.0593888	0.0582731	0.0810542	0.042899	0.0124995	5	-5	0.0094078		
HDR_bias	30	18	0.0670302	0.0625732	0.106069	0.0417058	0.0176294	5	-5	0.0137079		
HDR_bias	50	18	0.0733602	0.0737637	0.110842	0.0464788	0.0180596	5	-5	0.0248984		
HDR_bias	80	18	0.0915679	0.0910513	0.131811	0.0703149	0.0170336	5	-5	0.042186		
HDR_bias	100	18	0.107508	0.100452	0.228581	0.0700675	0.0368005	5	-5	0.0515867		
HDR_unbias	0	15	0.0407948	0.0381406	0.0786677	0.0176369	0.0173182	5	-5	0		
HDR_unbias	3	15	0.0600189	0.0486179	0.183049	0.0381406	0.0366875	5	-5	0.0104773		
HDR_unbias	10	15	0.050954	0.0476866	0.0951113	0.0176369	0.0213291	5	-5	0.009546		
HDR_unbias	30	15	0.0587771	0.0572036	0.0846194	0.0417203	0.0107274	5	-5	0.019063		
HDR_unbias	50	15	0.0851481	0.082	0.122513	0.0569562	0.0186337	5	-5	0.0438594		
HDR_unbias	80	15	0.110002	0.104628	0.214291	0.0584114	0.034344	5	-5	0.0664874		
HDR_unbias	100	15	0.138284	0.115615	0.323707	0.0798609	0.06979	5	-5	0.0774744		

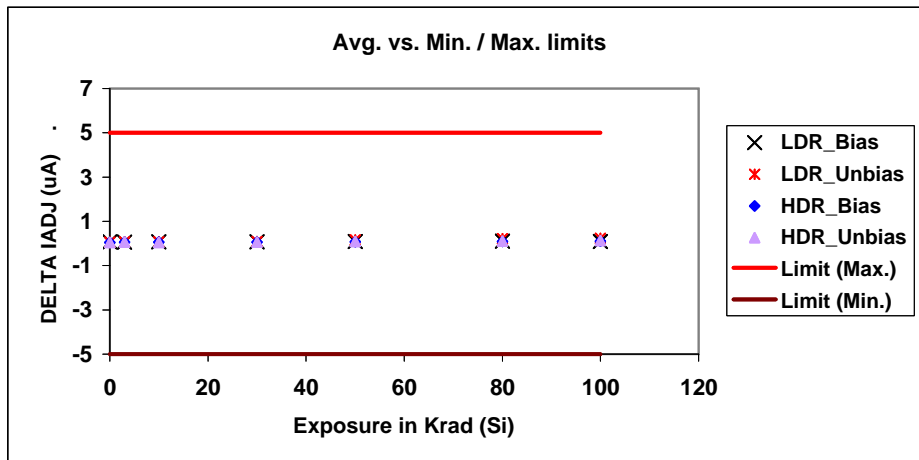

LM117HVHRLQMLV Radiation Data

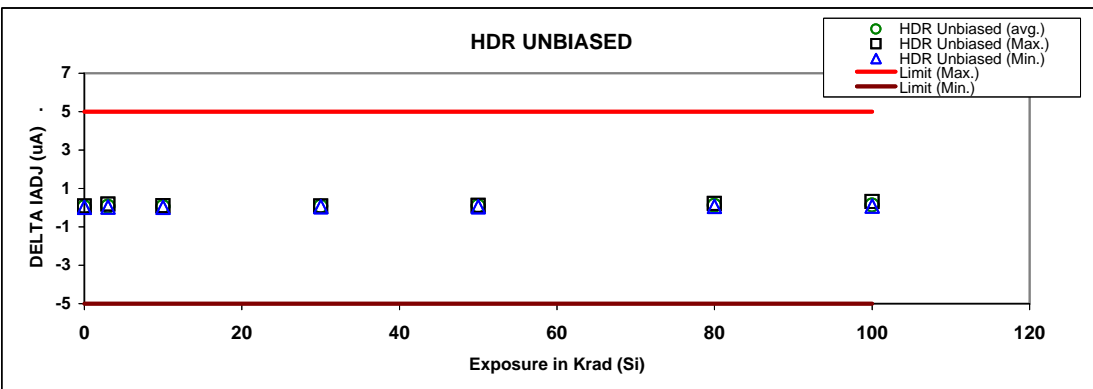
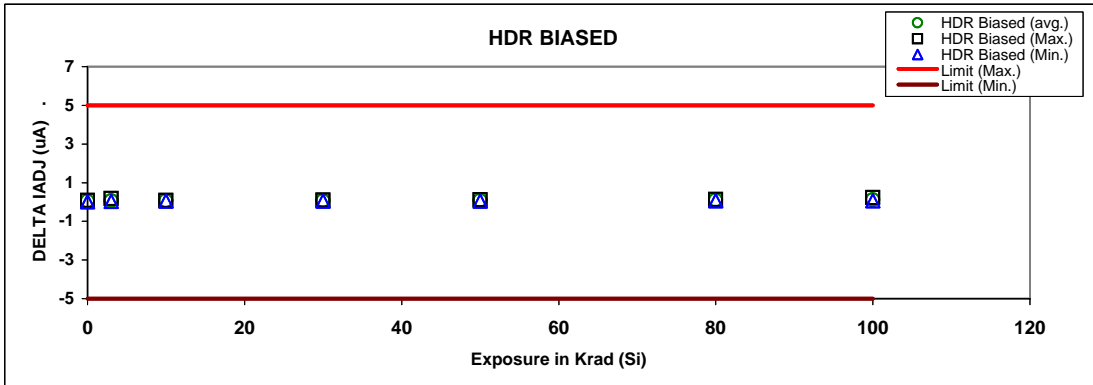
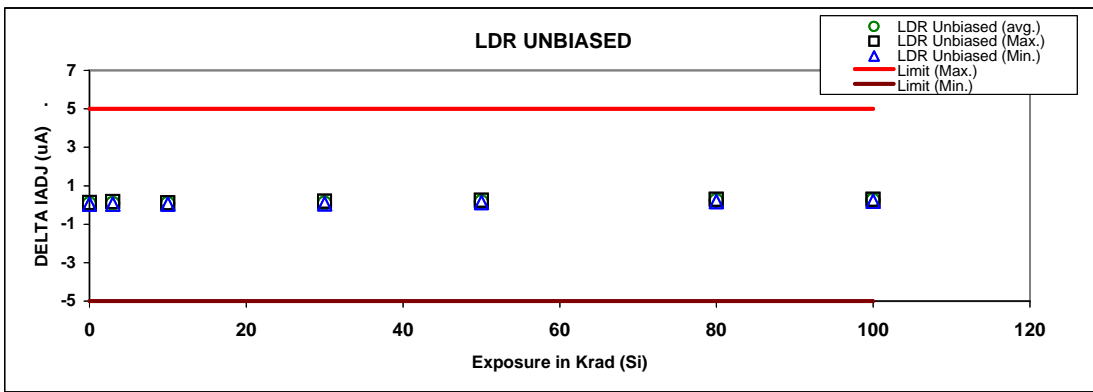
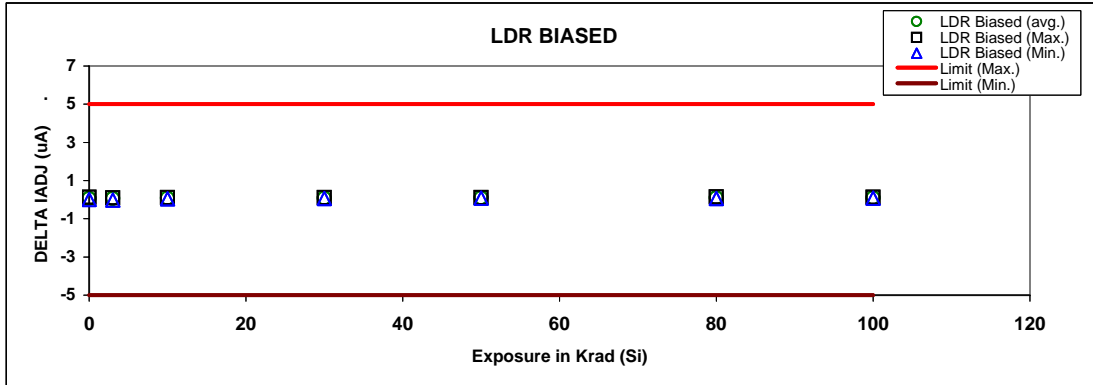

LM117HVHRLQMLV Radiation Data

TEST ID 500 - DELTA IADJ; VDIFF=40V, 10 MA<=IL<=150 MA (UA)

TEST_BIAS	DOSE (k)	OBS	AVG	MEDIAN	MAX	MIN	SIGMA	UTL	LTL	Median Delta (from 0 rad)	Delta Ratio (to HDR)	Max Unit Delta
LDR_bias	0	15	0.0641235	0.0619912	0.0927248	0.041473	0.0137938	5	-5	0		
LDR_bias	3	15	0.0641516	0.0641157	0.0867585	0.0298023	0.0152217	5	-5	0.0021245		
LDR_bias	10	15	0.0675665	0.065309	0.0915315	0.0464788	0.0135997	5	-5	0.0033178		
LDR_bias	30	15	0.0685191	0.067681	0.0951113	0.0417058	0.0136292	5	-5	0.0056898		
LDR_bias	50	15	0.0796601	0.077227	0.100117	0.0617292	0.0118607	5	-5	0.0152358		
LDR_bias	80	15	0.0813423	0.0810396	0.105836	0.0500586	0.016018	5	-5	0.0190484		
LDR_bias	100	15	0.0747852	0.0727159	0.0953441	0.0569562	0.0102556	5	-5	0.0107247	0.90	
LDR_unbias	0	15	0.0661899	0.0584114	0.091517	0.0512518	0.0124067	5	-5	0		
LDR_unbias	3	15	0.063167	0.0631699	0.0927248	0.0274158	0.0202979	5	-5	0.0047585		
LDR_unbias	10	15	0.0673307	0.0700675	0.0858126	0.0464934	0.0109757	5	-5	0.0116561		
LDR_unbias	30	15	0.0747183	0.0748405	0.101325	0.0521977	0.0126406	5	-5	0.0164291		
LDR_unbias	50	15	0.0960814	0.0929722	0.142521	0.0762811	0.0155279	5	-5	0.0345608		
LDR_unbias	80	15	0.121426	0.122513	0.148735	0.0807922	0.0186602	5	-5	0.0641016		
LDR_unbias	100	15	0.123919	0.123968	0.151122	0.089145	0.0167207	5	-5	0.0655566	2.75	
HDR_bias	0	18	0.0624196	0.0624423	0.103435	0.0212021	0.0169024	5	-5	0		
HDR_bias	3	18	0.0572294	0.0570799	0.0760338	0.0357541	0.01035	5	-5	-0.0053624		
HDR_bias	10	18	0.0597599	0.0589935	0.0879372	0.0369473	0.0147474	5	-5	-0.0034488		
HDR_bias	30	18	0.0677699	0.065309	0.09629	0.0476721	0.0123294	5	-5	0.0028667		
HDR_bias	50	18	0.0598132	0.0643486	0.0855653	0.0381406	0.0162611	5	-5	0.0019063		
HDR_bias	80	18	0.0695048	0.0705404	0.0858126	0.0331202	0.0121868	5	-5	0.0080981		
HDR_bias	100	18	0.0724984	0.0743676	0.0891305	0.0524451	0.0103241	5	-5	0.0119253		
HDR_unbias	0	15	0.0646959	0.0619912	0.0858272	0.0476866	0.0109701	5	-5	0		
HDR_unbias	3	15	0.0737559	0.0762957	0.129672	0.0476721	0.0203664	5	-5	0.0143045		
HDR_unbias	10	15	0.0585899	0.0569707	0.0798609	0.0464788	0.0101593	5	-5	-0.0050205		
HDR_unbias	30	15	0.0663286	0.0664877	0.0858272	0.0381406	0.0122442	5	-5	0.0044965		
HDR_unbias	50	15	0.0768652	0.0762957	0.114174	0.0524451	0.0182193	5	-5	0.0143045		
HDR_unbias	80	15	0.0832544	0.0762811	0.115368	0.0572181	0.0166925	5	-5	0.0142899		
HDR_unbias	100	15	0.085605	0.0858126	0.101063	0.0703149	0.0095656	5	-5	0.0238214		

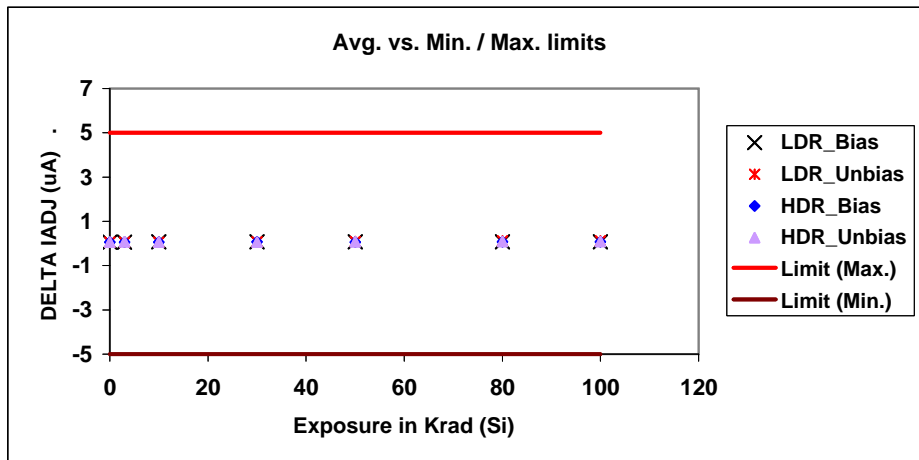

LM117HVHRLQMLV Radiation Data

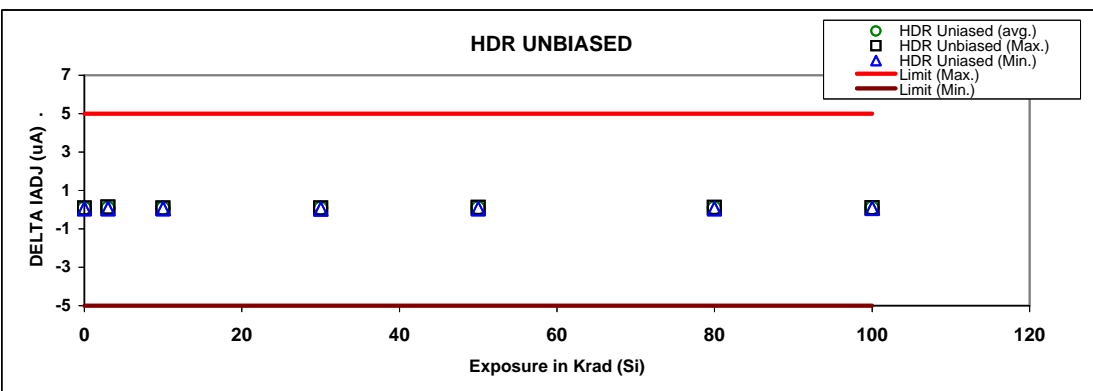
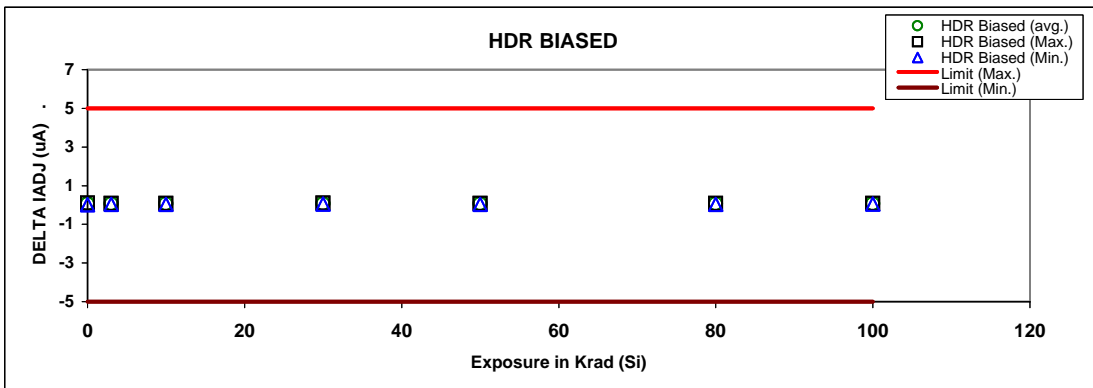
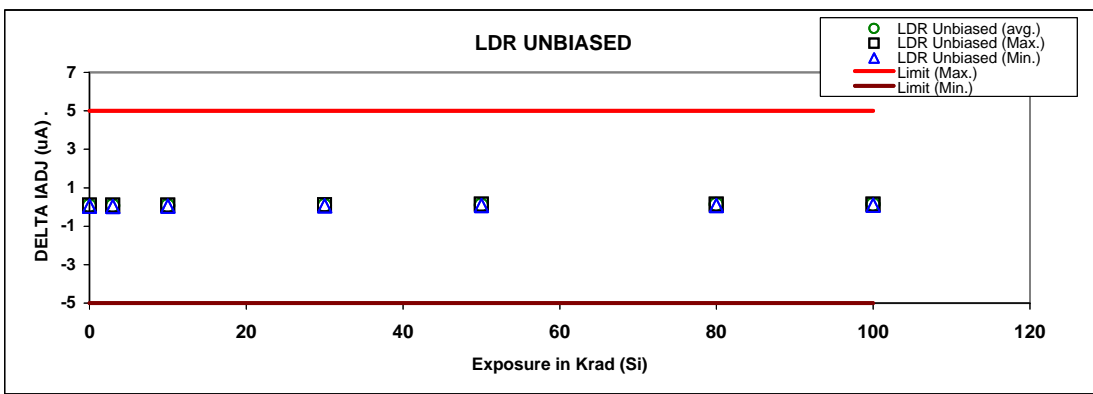
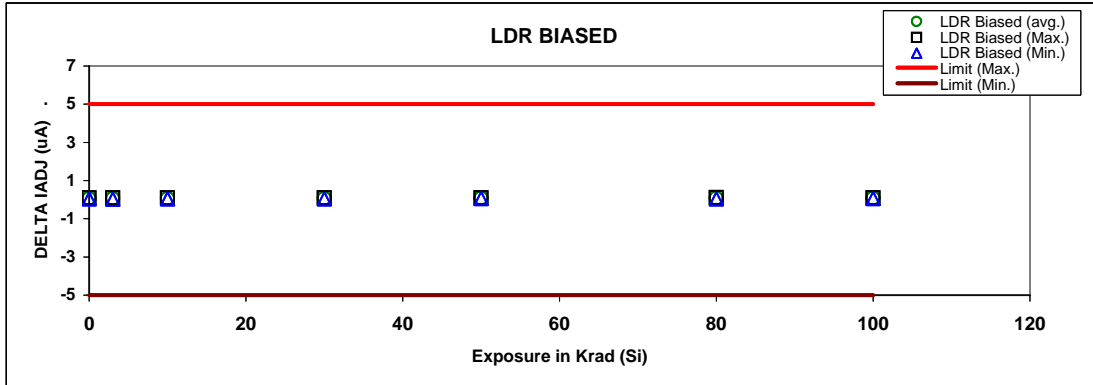

LM117HVHRLQMLV Radiation Data

TEST ID 600 - IQ; VDIFF=3V, VOUT=1.7 V (MA)

TEST_BIAS	DOSE (k)	OBS	AVG	MEDIAN	MAX	MIN	SIGMA	UTL	LTL	Median Delta (from 0 rad)	Delta Ratio (to HDR)	Max Unit Delta
LDR_bias	0	15	0.908979	0.941452	0.953566	0.783652	0.064638	5	0	0		
LDR_bias	3	15	0.899532	0.925504	0.934043	0.806153	0.0484477	5	0	-0.015948		
LDR_bias	10	15	0.888356	0.906194	0.918416	0.816908	0.0390433	5	0	-0.035258		
LDR_bias	30	15	0.896977	0.911777	0.925504	0.835819	0.0328845	5	0	-0.029682		
LDR_bias	50	15	0.861474	0.872032	0.888056	0.807449	0.0274033	5	0	-0.06942		
LDR_bias	80	15	0.837545	0.848631	0.859308	0.788156	0.0237973	5	0	-0.092821		
LDR_bias	100	15	0.82516	0.834898	0.848936	0.773889	0.0232673	5	0	-0.106554	0.91	
LDR_unbias	0	15	0.936329	0.944355	0.969438	0.815014	0.0347632	5	0	0		
LDR_unbias	3	15	0.922583	0.930376	0.948753	0.816296	0.0306102	5	0	-0.013979		
LDR_unbias	10	15	0.914737	0.913909	0.934043	0.89257	0.010485	5	0	-0.030446		
LDR_unbias	30	15	0.902479	0.90902	0.922983	0.807375	0.0279598	5	0	-0.035335		
LDR_unbias	50	15	0.867323	0.871497	0.887903	0.775645	0.0273531	5	0	-0.072858		
LDR_unbias	80	15	0.837276	0.842842	0.856176	0.749495	0.0262927	5	0	-0.101513		
LDR_unbias	100	15	0.821545	0.828024	0.839787	0.736602	0.0254831	5	0	-0.116331	1.39	
HDR_bias	0	18	0.94261	0.944721	0.960326	0.926459	0.00925519	5	0	0		
HDR_bias	3	18	0.939239	0.938489	0.957882	0.925619	0.00797206	5	0	-0.006232		
HDR_bias	10	18	0.919561	0.92067	0.940192	0.904187	0.0086953	5	0	-0.024051		
HDR_bias	30	18	0.887636	0.887698	0.911138	0.871864	0.0096269	5	0	-0.057023		
HDR_bias	50	18	0.865498	0.864616	0.890393	0.83534	0.0126905	5	0	-0.080105		
HDR_bias	80	18	0.841965	0.841053	0.870031	0.803612	0.0155652	5	0	-0.103668		
HDR_bias	100	18	0.828252	0.827587	0.854098	0.787588	0.0165081	5	0	-0.117134		
HDR_unbias	0	15	0.942097	0.938541	0.97239	0.923892	0.0125565	5	0	0		
HDR_unbias	3	15	0.936062	0.934187	0.958734	0.917262	0.0110951	5	0	-0.004354		
HDR_unbias	10	15	0.925001	0.922746	0.944712	0.906187	0.011043	5	0	-0.015795		
HDR_unbias	30	15	0.899073	0.896595	0.924655	0.880647	0.011062	5	0	-0.041946		
HDR_unbias	50	15	0.884009	0.884848	0.903835	0.866243	0.0105921	5	0	-0.053693		
HDR_unbias	80	15	0.863962	0.86328	0.885535	0.84527	0.0102292	5	0	-0.075261		
HDR_unbias	100	15	0.8562	0.855107	0.880494	0.834516	0.0118727	5	0	-0.083434		

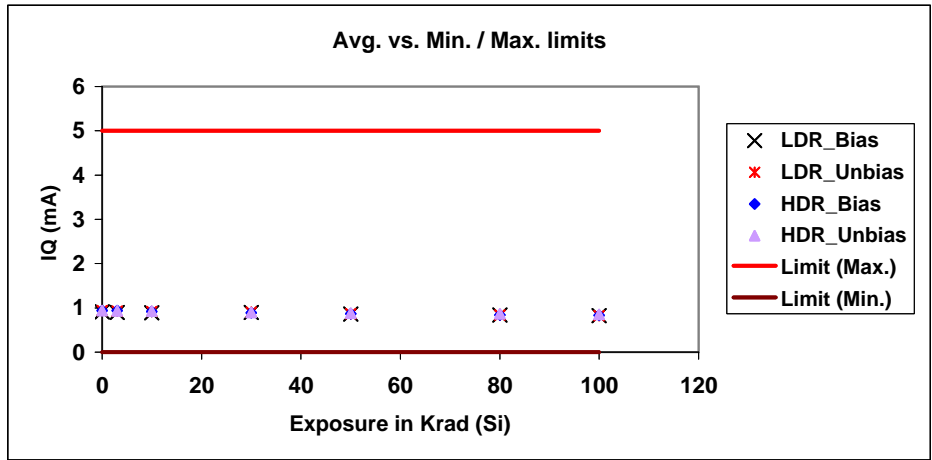

LM117HVHRLQMLV Radiation Data

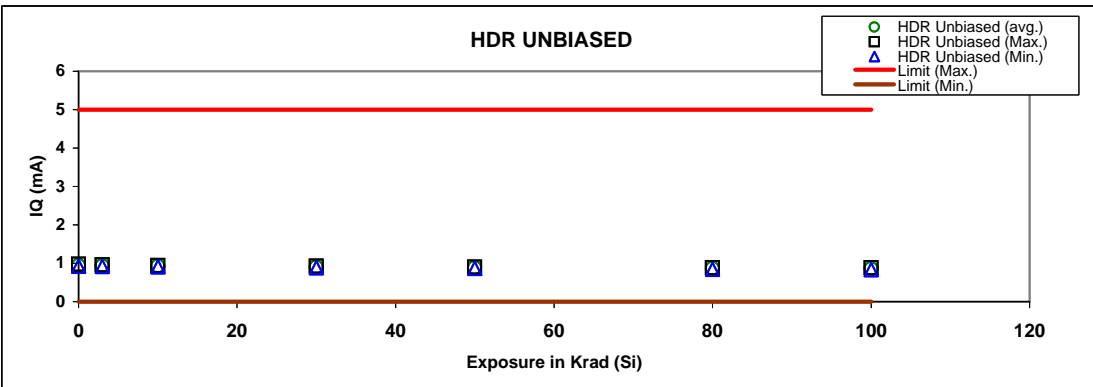
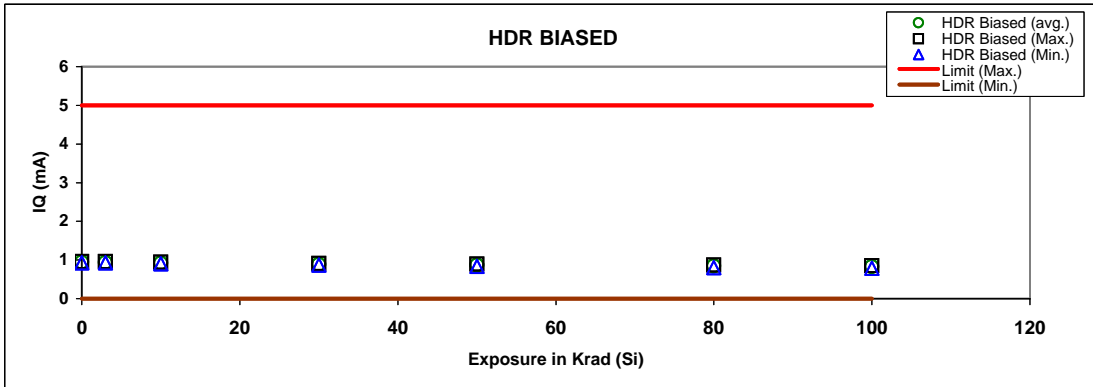
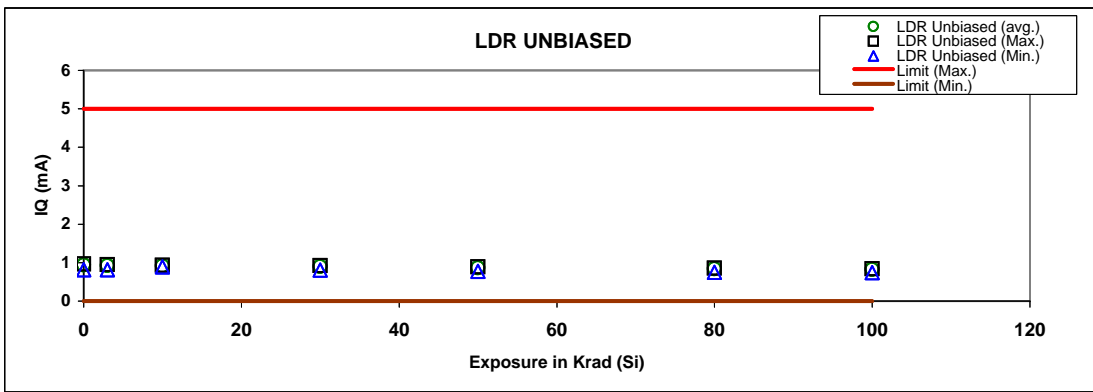
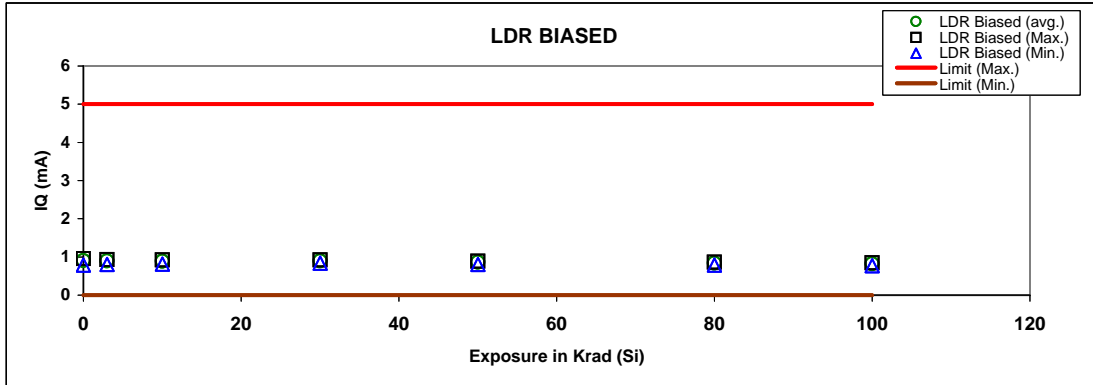

LM117HVHRLQMLV Radiation Data

TEST ID 700 - IQ; VDIFF=40V, VOUT=1.7 V (MA)

TEST_BIAS	DOSE (k)	OBS	AVG	MEDIAN	MAX	MIN	SIGMA	UTL	LTL	Median Delta (from 0 rad)	Delta Ratio (to HDR)	Max Unit Delta
LDR_bias	0	15	3.07485	3.09965	3.11948	2.97147	0.0555796	5	0	0		
LDR_bias	3	15	3.06891	3.08989	3.10385	2.99381	0.0414333	5	0	-0.00976		
LDR_bias	10	15	3.06233	3.07885	3.09629	3.00563	0.0340212	5	0	-0.0208		
LDR_bias	30	15	3.07028	3.08441	3.10378	3.02087	0.0302753	5	0	-0.01524		
LDR_bias	50	15	3.04048	3.0527	3.07276	2.99834	0.026056	5	0	-0.04695		
LDR_bias	80	15	3.00958	3.01823	3.03562	2.97607	0.0211681	5	0	-0.08142		
LDR_bias	100	15	2.99209	2.99987	3.01853	2.95975	0.0192756	5	0	-0.09978	1.01	
LDR_unbias	0	15	3.09789	3.1021	3.14305	2.99067	0.0326656	5	0	0		
LDR_unbias	3	15	3.08755	3.09279	3.13222	2.98825	0.0307748	5	0	-0.00931		
LDR_unbias	10	15	3.08255	3.08099	3.1207	3.06244	0.014365	5	0	-0.02111		
LDR_unbias	30	15	3.07231	3.07457	3.113	2.98009	0.0288385	5	0	-0.02753		
LDR_unbias	50	15	3.04867	3.05201	3.08945	2.95998	0.0281986	5	0	-0.05009		
LDR_unbias	80	15	3.0185	3.02273	3.05675	2.93588	0.0268628	5	0	-0.07937		
LDR_unbias	100	15	3.00511	3.00999	3.04317	2.92499	0.0267125	5	0	-0.09211	1.47	
HDR_bias	0	18	3.10503	3.10426	3.12859	3.06857	0.0147336	5	0	0		
HDR_bias	3	18	3.0972	3.09224	3.12408	3.07002	0.0137364	5	0	-0.01202		
HDR_bias	10	18	3.07447	3.07369	3.09877	3.03738	0.0148919	5	0	-0.03057		
HDR_bias	30	18	3.04528	3.0428	3.07094	3.00993	0.0143012	5	0	-0.06146		
HDR_bias	50	18	3.02548	3.02278	3.05256	2.98896	0.0156154	5	0	-0.08148		
HDR_bias	80	18	3.00807	3.00714	3.03738	2.97226	0.017167	5	0	-0.09712		
HDR_bias	100	18	3.00682	3.00509	3.03738	2.97203	0.017354	5	0	-0.09917		
HDR_unbias	0	15	3.1067	3.10174	3.1458	3.08282	0.0191486	5	0	0		
HDR_unbias	3	15	3.10011	3.0957	3.13849	3.07551	0.0192923	5	0	-0.00604		
HDR_unbias	10	15	3.0912	3.08823	3.12995	3.06703	0.0190625	5	0	-0.01351		
HDR_unbias	30	15	3.07312	3.06947	3.11249	3.04804	0.0192174	5	0	-0.03227		
HDR_unbias	50	15	3.06231	3.05971	3.09906	3.03776	0.018559	5	0	-0.04203		
HDR_unbias	80	15	3.04919	3.04691	3.08808	3.02426	0.0192274	5	0	-0.05483		
HDR_unbias	100	15	3.04287	3.03897	3.08282	3.01503	0.019723	5	0	-0.06277		

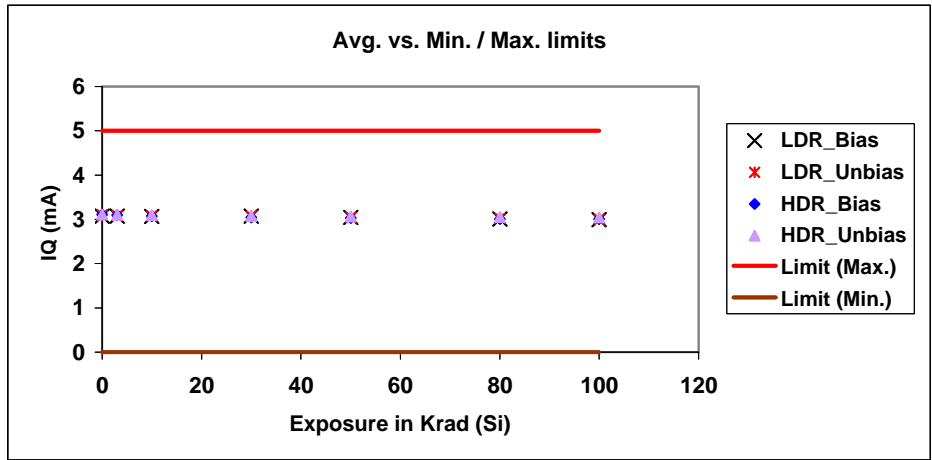

LM117HVHRLQMLV Radiation Data

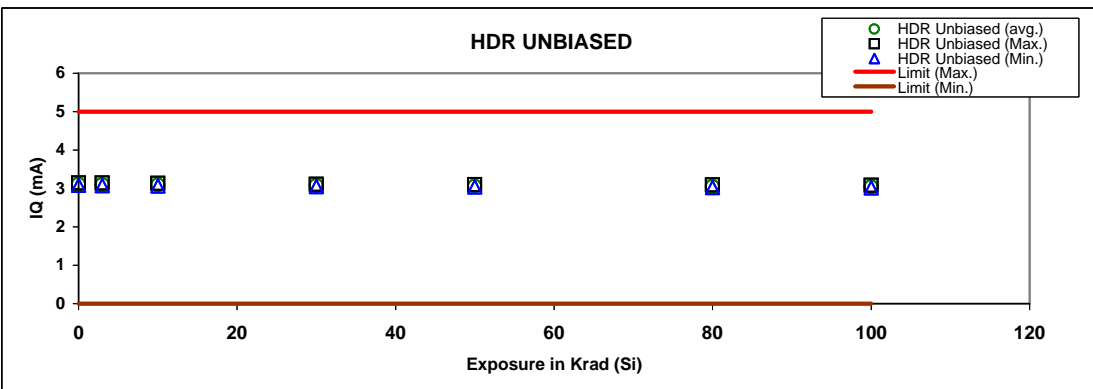
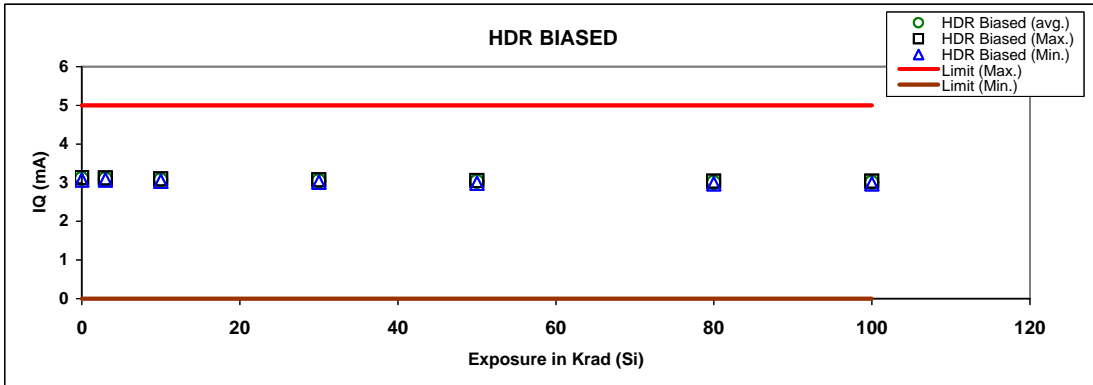
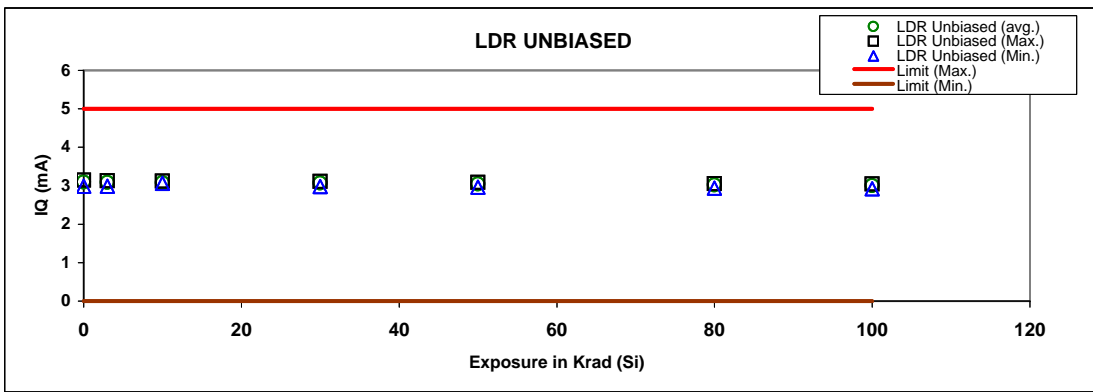
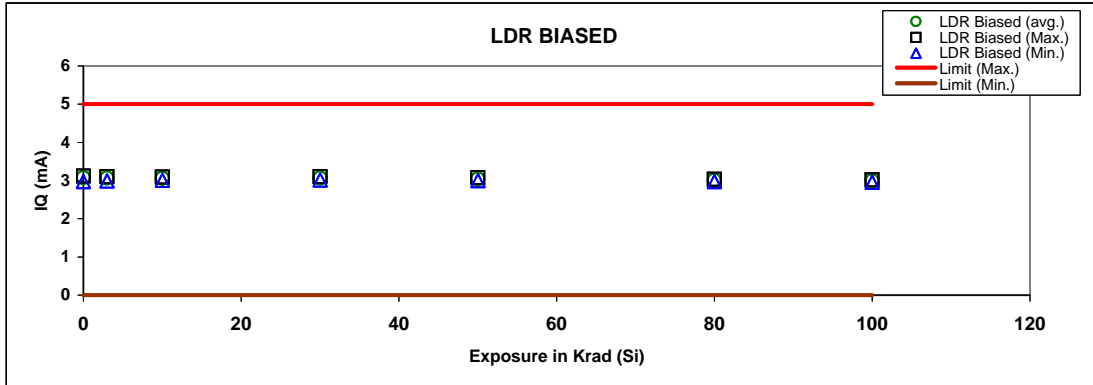

LM117HVHRLQMLV Radiation Data

TEST ID 800 - IQ; VIN=60V, VOUT=1.7 V (V)

TEST_BIAS	DOSE (k)	OBS	AVG	MEDIAN	MAX	MIN	SIGMA	UTL	LTL	Median Delta (from 0 rad)	Delta Ratio (to HDR)	Max Unit Delta
LDR_bias	0	15	4.29437	4.31608	4.34665	4.19047	0.0578412	8.2	0.25	0		
LDR_bias	3	15	4.28747	4.31249	4.32653	4.2084	0.0446113	8.2	0.25	-0.00359		
LDR_bias	10	15	4.28074	4.30029	4.3154	4.22038	0.0365992	8.2	0.25	-0.01579		
LDR_bias	30	15	4.2872	4.2996	4.32279	4.23129	0.0341838	8.2	0.25	-0.01648		
LDR_bias	50	15	4.25512	4.25961	4.29004	4.20593	0.0290844	8.2	0.25	-0.05647		
LDR_bias	80	15	4.21748	4.22035	4.24375	4.18284	0.0222292	8.2	0.25	-0.09573		
LDR_bias	100	15	4.19617	4.19892	4.22417	4.16689	0.0197423	8.2	0.25	-0.11716	1.87	
LDR_unbias	0	15	4.31438	4.32134	4.36558	4.20374	0.0344365	8.2	0.25	0		
LDR_unbias	3	15	4.30552	4.30968	4.35947	4.1959	0.0343819	8.2	0.25	-0.01166		
LDR_unbias	10	15	4.30062	4.29893	4.34749	4.28262	0.0166359	8.2	0.25	-0.02241		
LDR_unbias	30	15	4.2885	4.29114	4.33805	4.18508	0.0323969	8.2	0.25	-0.0302		
LDR_unbias	50	15	4.26557	4.26945	4.31513	4.16574	0.0315542	8.2	0.25	-0.05189		
LDR_unbias	80	15	4.23148	4.23522	4.27854	4.14011	0.03003	8.2	0.25	-0.08612		
LDR_unbias	100	15	4.21754	4.21944	4.2645	4.13128	0.0294908	8.2	0.25	-0.1019	1.52	
HDR_bias	0	18	4.32413	4.32071	4.35942	4.2792	0.0190643	8.2	0.25	0		
HDR_bias	3	18	4.31116	4.30462	4.34332	4.27867	0.0172646	8.2	0.25	-0.01609		
HDR_bias	10	18	4.28845	4.28635	4.31648	4.24419	0.0179262	8.2	0.25	-0.03436		
HDR_bias	30	18	4.25972	4.25565	4.28925	4.21491	0.0180179	8.2	0.25	-0.06506		
HDR_bias	50	18	4.23878	4.2369	4.27034	4.19225	0.0191856	8.2	0.25	-0.08381		
HDR_bias	80	18	4.23222	4.2321	4.26767	4.18675	0.0203591	8.2	0.25	-0.08861		
HDR_bias	100	18	4.25811	4.25791	4.29657	4.21277	0.0215392	8.2	0.25	-0.0628		
HDR_unbias	0	15	4.32964	4.32299	4.40543	4.29286	0.0293042	8.2	0.25	0		
HDR_unbias	3	15	4.31794	4.3133	4.36088	4.28654	0.0221595	8.2	0.25	-0.00969		
HDR_unbias	10	15	4.30627	4.3043	4.34937	4.27609	0.0205007	8.2	0.25	-0.01869		
HDR_unbias	30	15	4.29079	4.28868	4.33626	4.25953	0.0210442	8.2	0.25	-0.03431		
HDR_unbias	50	15	4.28095	4.278	4.3249	4.24986	0.0208486	8.2	0.25	-0.04499		
HDR_unbias	80	15	4.269	4.2667	4.31581	4.2359	0.0214625	8.2	0.25	-0.05629		
HDR_unbias	100	15	4.26159	4.25596	4.30872	4.23065	0.0212637	8.2	0.25	-0.06703		

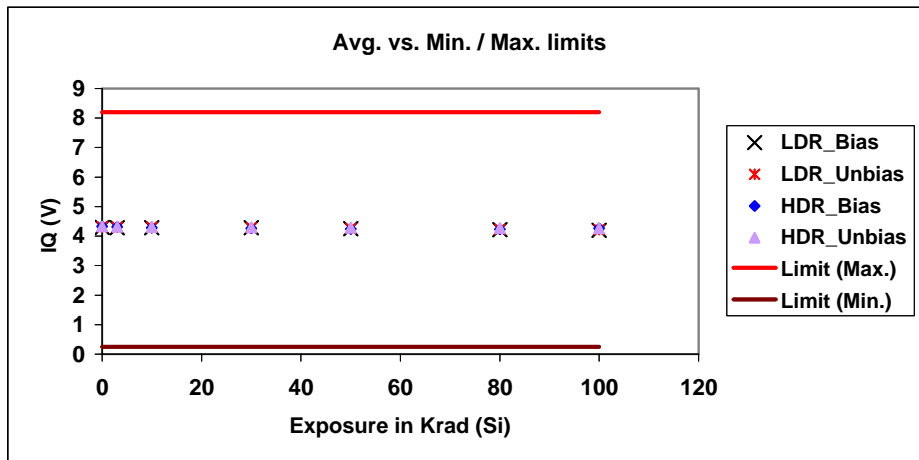

LM117HVHRLQMLV Radiation Data

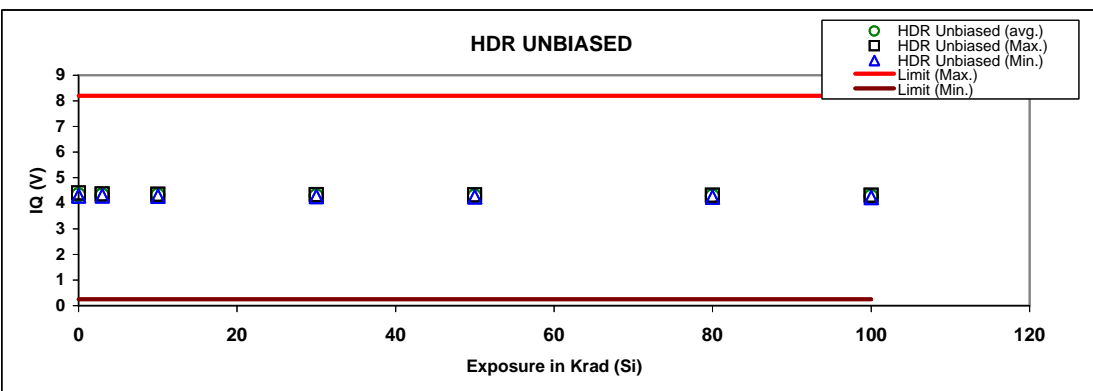
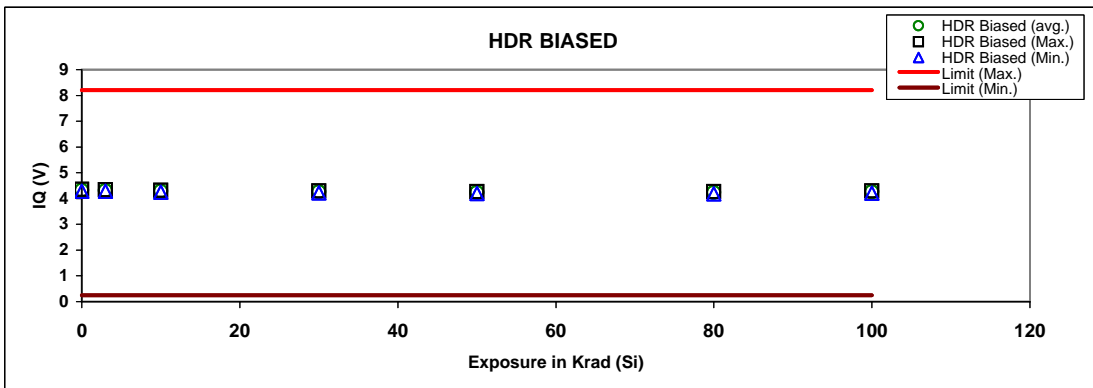
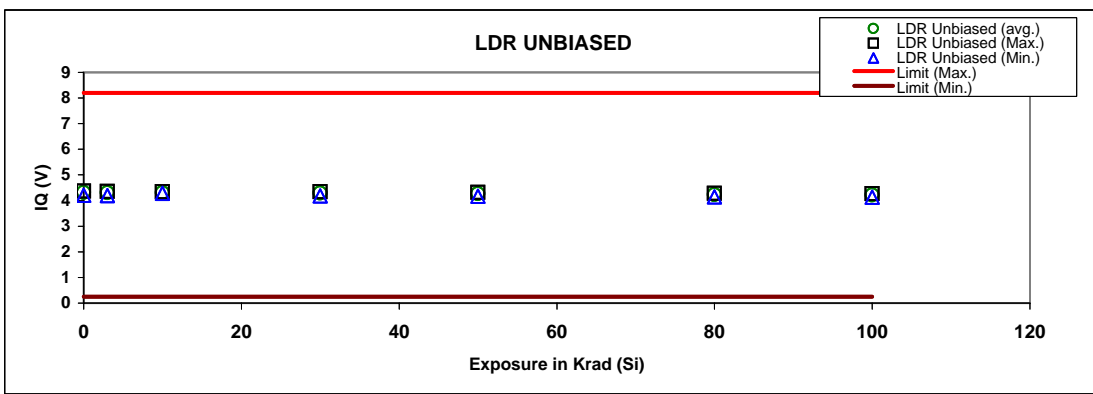
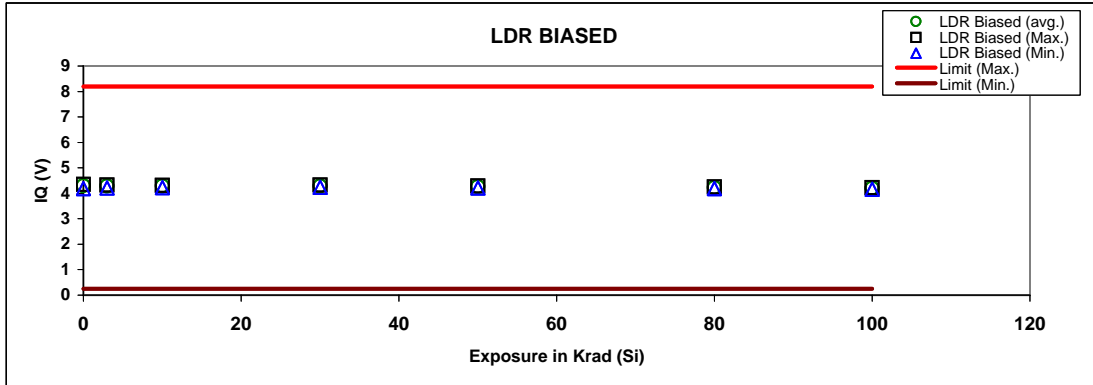

LM117HVHRLQMLV Radiation Data

TEST ID 900 - VREF; VDIFF=3V, IL=8MA (V)

TEST_BIAS	DOSE (k)	OBS	AVG	MEDIAN	MAX	MIN	SIGMA	UTL	LTL	Median Delta (from 0 rad)	Delta Ratio (to HDR)	Max Unit Delta
LDR_bias	0	15	1.24822	1.24922	1.25046	1.23618	0.00355481	1.3	1.2	0		
LDR_bias	3	15	1.24925	1.25056	1.25219	1.23835	0.00374021	1.45	1.2	0.00134		
LDR_bias	10	15	1.25179	1.25351	1.25571	1.24158	0.00407331	1.45	1.2	0.00429		
LDR_bias	30	15	1.25437	1.25562	1.25778	1.24632	0.00334129	1.45	1.2	0.0064		
LDR_bias	50	15	1.2541	1.25566	1.2618	1.24171	0.00575252	1.45	1.2	0.00644		
LDR_bias	80	15	1.24911	1.25097	1.25788	1.23671	0.00564486	1.45	1.2	0.00175		
LDR_bias	100	15	1.24562	1.24734	1.25422	1.23327	0.00556261	1.45	1.2	-0.00188	1.81	
LDR_unbias	0	15	1.24973	1.24984	1.25124	1.24727	0.00096489	1.3	1.2	0		
LDR_unbias	3	15	1.25149	1.25093	1.26155	1.24888	0.00292152	1.45	1.2	0.00109		
LDR_unbias	10	15	1.25644	1.25562	1.26248	1.25395	0.00223722	1.45	1.2	0.00578		
LDR_unbias	30	15	1.26463	1.26376	1.27423	1.25807	0.0043004	1.45	1.2	0.01392		
LDR_unbias	50	15	1.28165	1.2799	1.28925	1.27601	0.00379065	1.45	1.2	0.03006		
LDR_unbias	80	15	1.28973	1.28823	1.29832	1.28387	0.00428816	1.45	1.2	0.03839		
LDR_unbias	100	15	1.29193	1.29103	1.30035	1.2847	0.00467977	1.45	1.2	0.04119	3.45	0.052
HDR_bias	0	18	1.24995	1.24984	1.25403	1.24657	0.00166394	1.3	1.2	0		
HDR_bias	3	18	1.24916	1.24887	1.25366	1.24634	0.00166884	1.45	1.2	-0.00097		
HDR_bias	10	18	1.24953	1.24947	1.25336	1.24587	0.00170186	1.45	1.2	-0.00037		
HDR_bias	30	18	1.24935	1.24977	1.25386	1.24217	0.00257985	1.45	1.2	-7E-05		
HDR_bias	50	18	1.2488	1.24996	1.25529	1.23615	0.00444447	1.45	1.2	0.00012		
HDR_bias	80	18	1.24792	1.24883	1.25672	1.23153	0.00618618	1.45	1.2	-0.00101		
HDR_bias	100	18	1.24773	1.2488	1.25724	1.23016	0.00680804	1.45	1.2	-0.00104		
HDR_unbias	0	15	1.24969	1.24987	1.25216	1.24693	0.00141948	1.3	1.2	0		
HDR_unbias	3	15	1.24974	1.2499	1.25223	1.24698	0.00138567	1.45	1.2	3E-05		
HDR_unbias	10	15	1.25008	1.25026	1.25261	1.24735	0.00137513	1.45	1.2	0.00039		
HDR_unbias	30	15	1.25142	1.25154	1.2535	1.24926	0.00121833	1.45	1.2	0.00167		
HDR_unbias	50	15	1.25428	1.25354	1.2564	1.2527	0.00132657	1.45	1.2	0.00367		
HDR_unbias	80	15	1.25978	1.25918	1.26257	1.2572	0.00183137	1.45	1.2	0.00931		
HDR_unbias	100	15	1.2623	1.2618	1.26509	1.25963	0.00170928	1.45	1.2	0.01193		

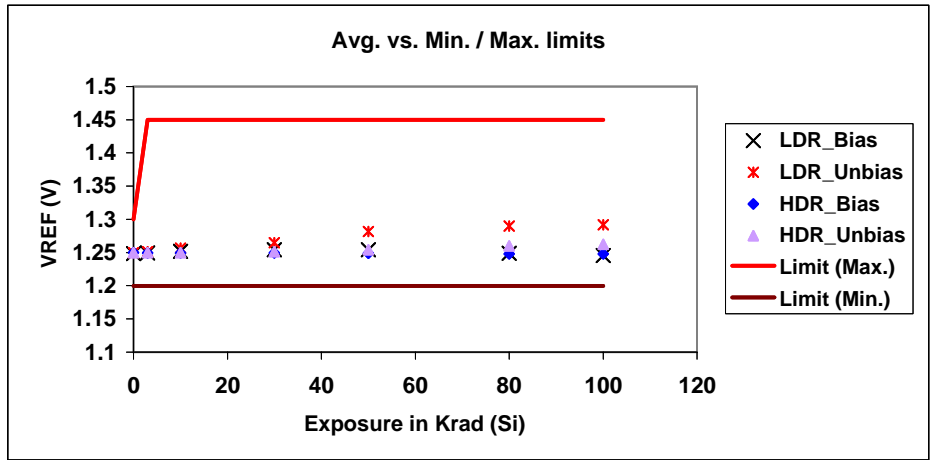

LM117HVHRLQMLV Radiation Data

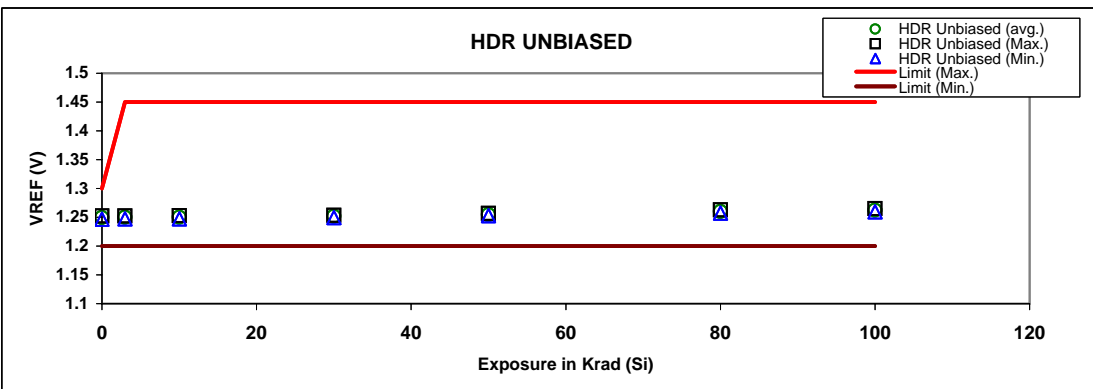
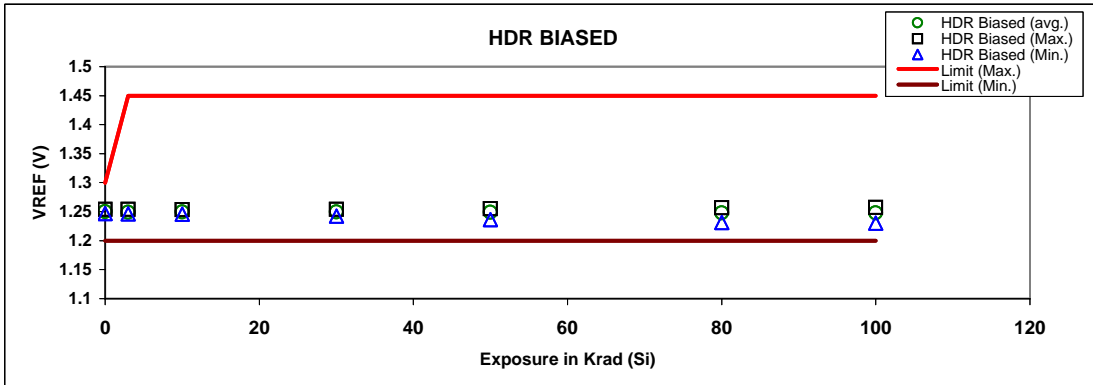
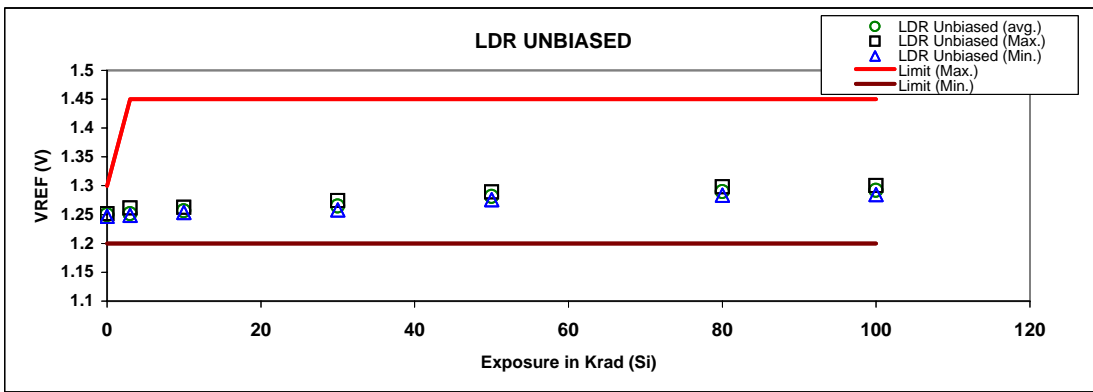
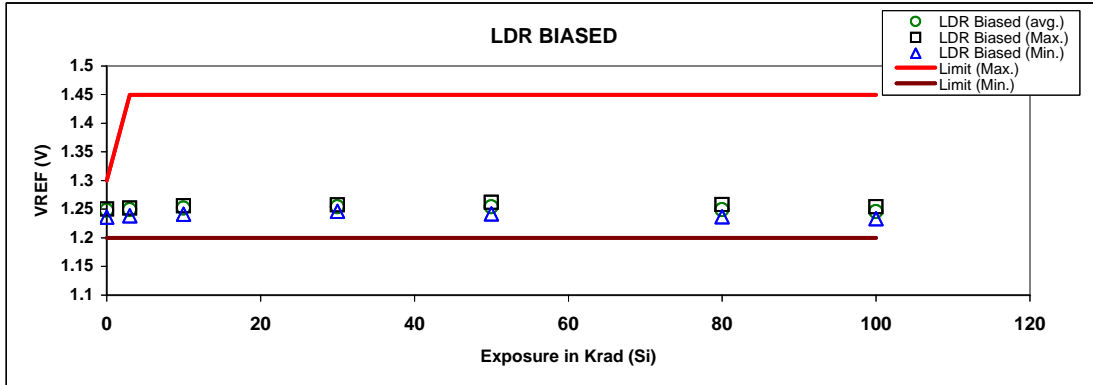

LM117HVHRLQMLV Radiation Data

TEST ID 1000 - VREF; VDIFF=40 V, IL=8MA (V)

TEST_BIAS	DOSE (k)	OBS	AVG	MEDIAN	MAX	MIN	SIGMA	UTL	LTL	Median Delta (from 0 rad)	Delta Ratio (to HDR)	Max Unit Delta
LDR_bias	0	15	1.25245	1.25296	1.25761	1.24381	0.00311744	1.3	1.2	0		
LDR_bias	3	15	1.2535	1.25418	1.25601	1.24456	0.00287417	1.45	1.2	0.00122		
LDR_bias	10	15	1.25674	1.25795	1.26053	1.24777	0.00353666	1.45	1.2	0.00499		
LDR_bias	30	15	1.25961	1.26022	1.26286	1.25272	0.00289989	1.45	1.2	0.00726		
LDR_bias	50	15	1.26065	1.26189	1.26913	1.24895	0.00563766	1.45	1.2	0.00893		
LDR_bias	80	15	1.25579	1.25723	1.26547	1.24399	0.00562445	1.45	1.2	0.00427		
LDR_bias	100	15	1.25215	1.25383	1.26158	1.24037	0.00554627	1.45	1.2	0.00087	0.31	
LDR_unbias	0	15	1.25306	1.2528	1.25807	1.25026	0.00169497	1.3	1.2	0		
LDR_unbias	3	15	1.2554	1.25427	1.27216	1.25255	0.0047176	1.45	1.2	0.00147		
LDR_unbias	10	15	1.26122	1.26009	1.26859	1.25837	0.00263864	1.45	1.2	0.00729		
LDR_unbias	30	15	1.27133	1.27012	1.28766	1.2632	0.00605471	1.45	1.2	0.01732		
LDR_unbias	50	15	1.29232	1.28975	1.30157	1.28528	0.00512941	1.45	1.2	0.03695		
LDR_unbias	80	15	1.30415	1.30424	1.31473	1.29627	0.00520937	1.45	1.2	0.05144		
LDR_unbias	100	15	1.30792	1.30564	1.31842	1.29997	0.00554263	1.45	1.2	0.05284	2.97	0.067
HDR_bias	0	18	1.25299	1.25268	1.25716	1.2496	0.00168588	1.3	1.2	0		
HDR_bias	3	18	1.25238	1.25204	1.25675	1.24961	0.00165109	1.45	1.2	-0.00064		
HDR_bias	10	18	1.25295	1.25282	1.25682	1.2494	0.00167632	1.45	1.2	0.00014		
HDR_bias	30	18	1.25347	1.25389	1.25813	1.24617	0.00261469	1.45	1.2	0.00121		
HDR_bias	50	18	1.25372	1.2548	1.26068	1.24068	0.00462136	1.45	1.2	0.00212		
HDR_bias	80	18	1.25394	1.25496	1.26333	1.23695	0.00645495	1.45	1.2	0.00228		
HDR_bias	100	18	1.25439	1.25552	1.26441	1.2362	0.00710101	1.45	1.2	0.00284		
HDR_unbias	0	15	1.25265	1.25273	1.25514	1.2499	0.00142193	1.3	1.2	0		
HDR_unbias	3	15	1.25295	1.25304	1.25524	1.25026	0.00130109	1.45	1.2	0.00031		
HDR_unbias	10	15	1.25341	1.25361	1.25575	1.2508	0.00132004	1.45	1.2	0.00088		
HDR_unbias	30	15	1.25554	1.25559	1.25758	1.25361	0.00119645	1.45	1.2	0.00286		
HDR_unbias	50	15	1.25947	1.2588	1.26192	1.25792	0.0015013	1.45	1.2	0.00607		
HDR_unbias	80	15	1.26674	1.26639	1.27035	1.26331	0.00226949	1.45	1.2	0.01366		
HDR_unbias	100	15	1.27032	1.27052	1.27341	1.26678	0.00214613	1.45	1.2	0.01779		

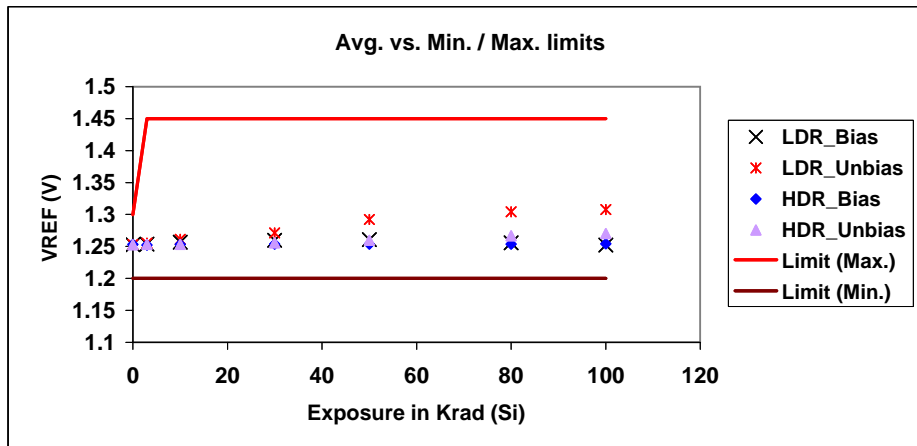

LM117HVHRLQMLV Radiation Data

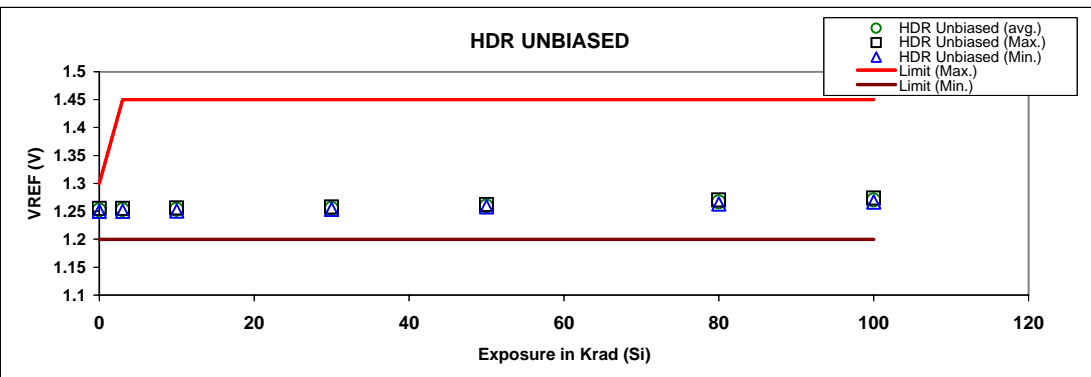
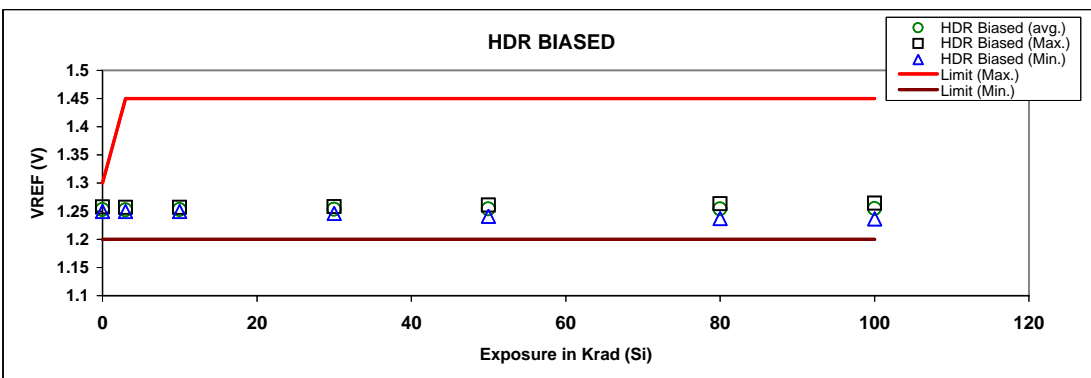
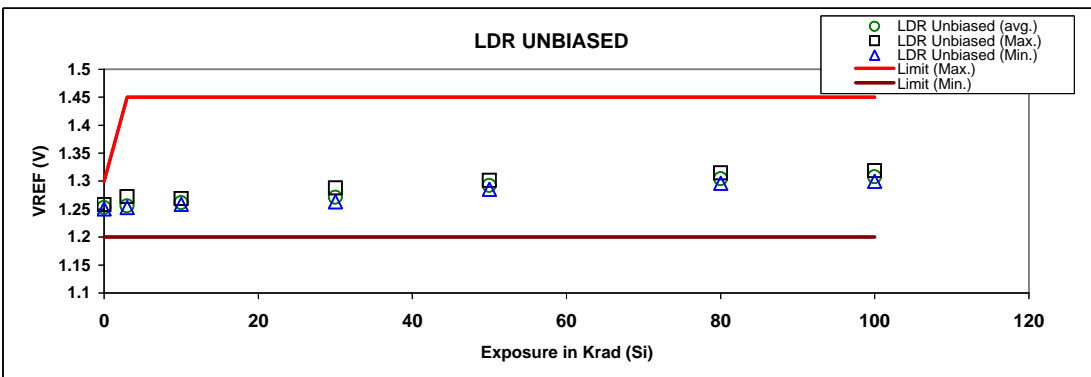
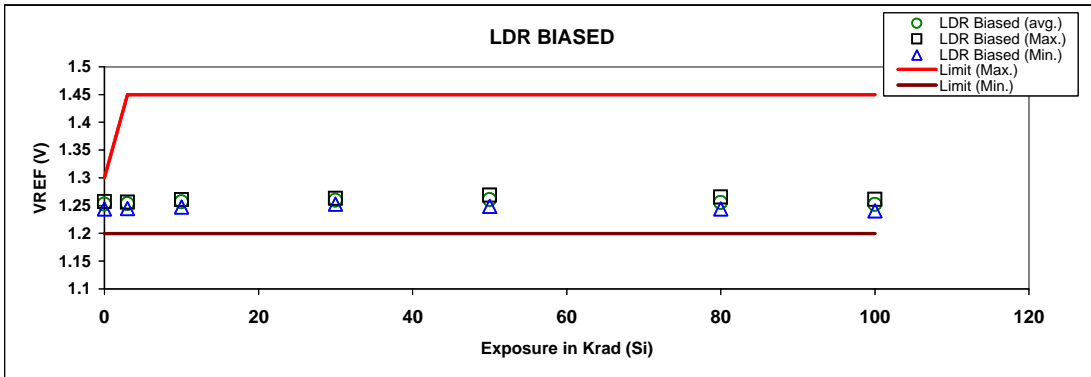

LM117HVHRLQMLV Radiation Data

TEST ID 1100 - VRLINE; 3V<=VDIFF<=40 V, IL=8MA (MV)

TEST_BIAS	DOSE (k)	OBS	AVG	MEDIAN	MAX	MIN	SIGMA	UTL	LTL	Median Delta (from 0 rad)	Delta Ratio (to HDR)	Max Unit Delta
LDR_bias	0	15	3.48237	2.26974	7.00283	2.10953	2.12504	8.64	-8.64	0		
LDR_bias	3	15	3.48549	2.90775	5.49316	2.63309	1.09011	40	-40	0.63801		
LDR_bias	10	15	4.2202	4.00639	5.55992	3.31879	0.681372	40	-40	1.73665		
LDR_bias	30	15	4.56594	4.37927	5.75161	3.61538	0.63015	40	-40	2.10953		
LDR_bias	50	15	5.84068	5.76401	6.56319	5.08404	0.456756	40	-40	3.49427		
LDR_bias	80	15	6.04299	5.93185	6.82449	5.23758	0.42959	40	-40	3.66211		
LDR_bias	100	15	5.82008	5.7888	6.55079	5.15079	0.385268	40	-40	3.51906	0.97	
LDR_unbias	0	15	2.61027	2.27165	7.18021	2.11906	1.26695	8.64	-8.64	0		
LDR_unbias	3	15	3.13918	2.67124	9.78851	2.47097	1.84495	40	-40	0.39959		
LDR_unbias	10	15	4.06094	3.88908	5.59998	3.62396	0.506909	40	-40	1.61743		
LDR_unbias	30	15	5.9878	5.49507	12.7602	4.51279	2.01223	40	-40	3.22342		
LDR_unbias	50	15	10.1117	9.29832	16.1743	8.67748	1.88697	40	-40	7.02667		
LDR_unbias	80	15	13.6895	12.9519	18.6472	11.8761	1.79901	40	-40	10.68025		
LDR_unbias	100	15	15.3131	14.6675	19.3443	13.3152	1.71521	40	-40	12.39585	2.34	15.66
HDR_bias	0	18	2.30784	2.3365	2.49863	2.13623	0.101563	8.64	-8.64	0		
HDR_bias	3	18	2.42652	2.4395	2.61593	2.28882	0.0781583	40	-40	0.103		
HDR_bias	10	18	2.69763	2.69413	2.83337	2.48909	0.103922	40	-40	0.35763		
HDR_bias	30	18	3.38623	3.38078	3.58677	3.17764	0.105547	40	-40	1.04428		
HDR_bias	50	18	4.17593	4.20141	4.4632	3.87287	0.189106	40	-40	1.86491		
HDR_bias	80	18	5.31933	5.25188	5.90801	4.77886	0.347443	40	-40	2.91538		
HDR_bias	100	18	5.97239	5.98097	6.62327	5.37872	0.408224	40	-40	3.64447		
HDR_unbias	0	15	2.24139	2.26021	2.37465	2.08759	0.0736304	8.64	-8.64	0		
HDR_unbias	3	15	2.43498	2.35558	3.7384	2.17628	0.367528	40	-40	0.09537		
HDR_unbias	10	15	2.62597	2.61211	2.75612	2.45094	0.0738597	40	-40	0.3519		
HDR_unbias	30	15	3.37257	3.37601	3.66306	3.14808	0.148251	40	-40	1.1158		
HDR_unbias	50	15	4.46014	4.41551	5.02682	3.92056	0.362187	40	-40	2.1553		
HDR_unbias	80	15	6.29896	6.3858	7.13634	5.25951	0.558202	40	-40	4.12559		
HDR_unbias	100	15	4.00734	7.55787	4.44412	3.66211	0.216887	40	-40	5.29766		

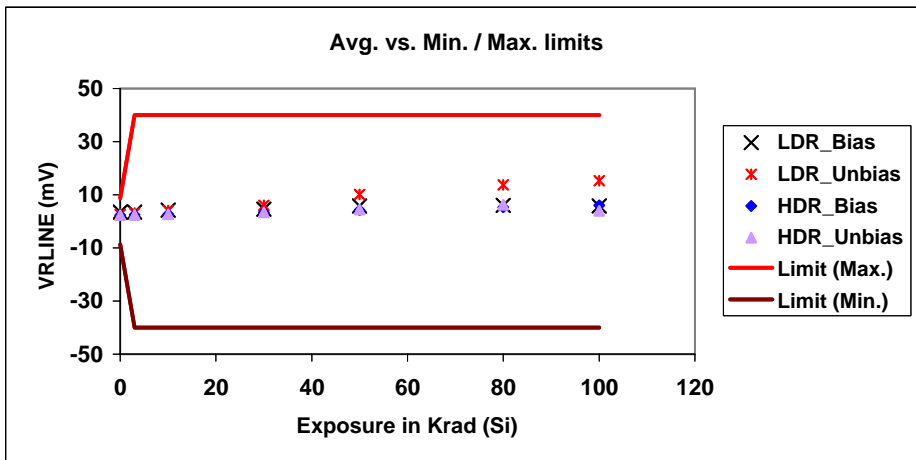

LM117HVHRLQMLV Radiation Data

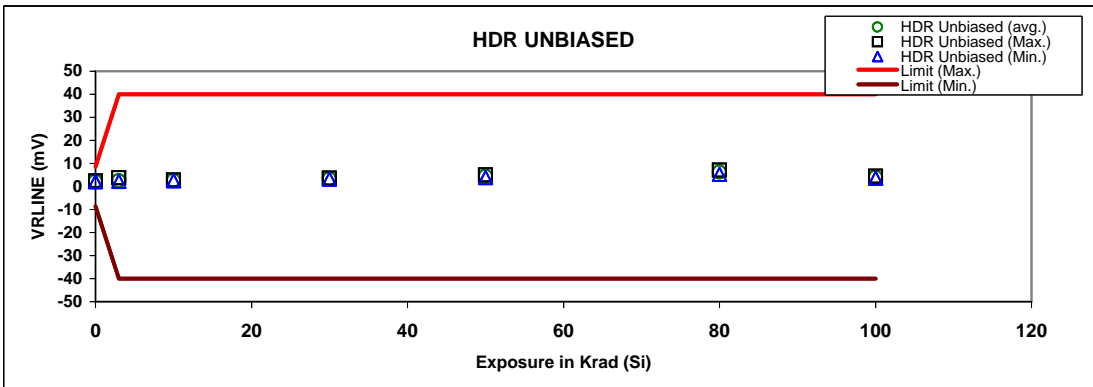
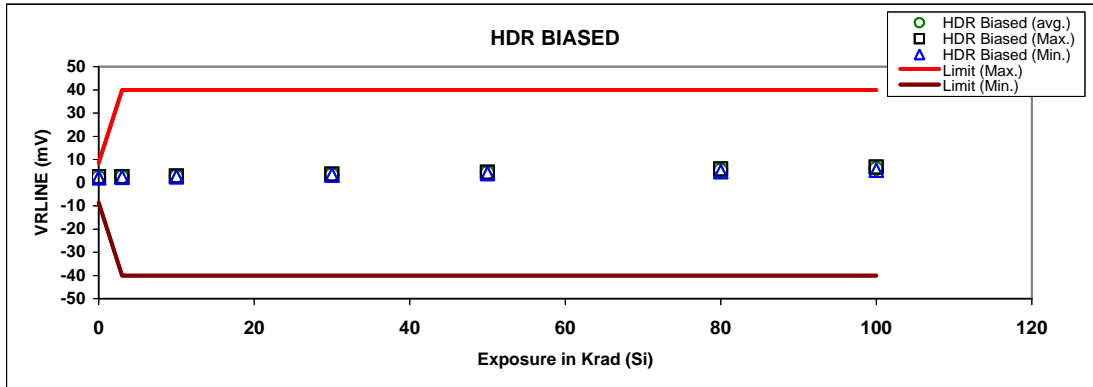
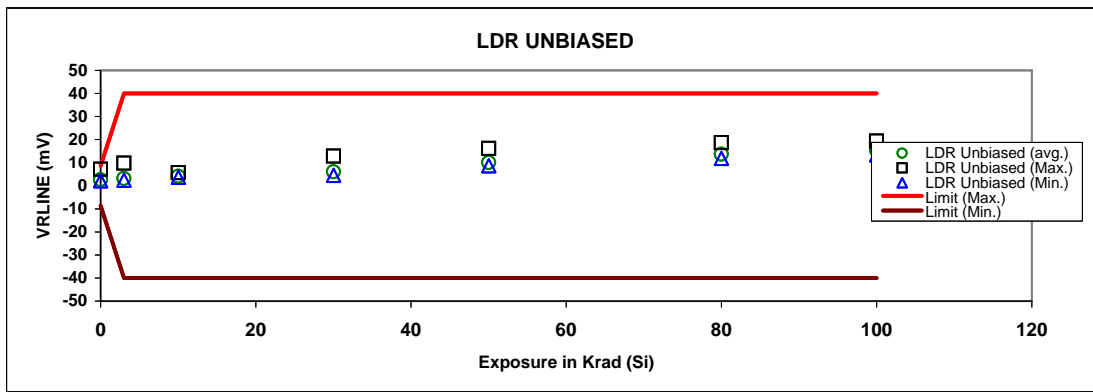
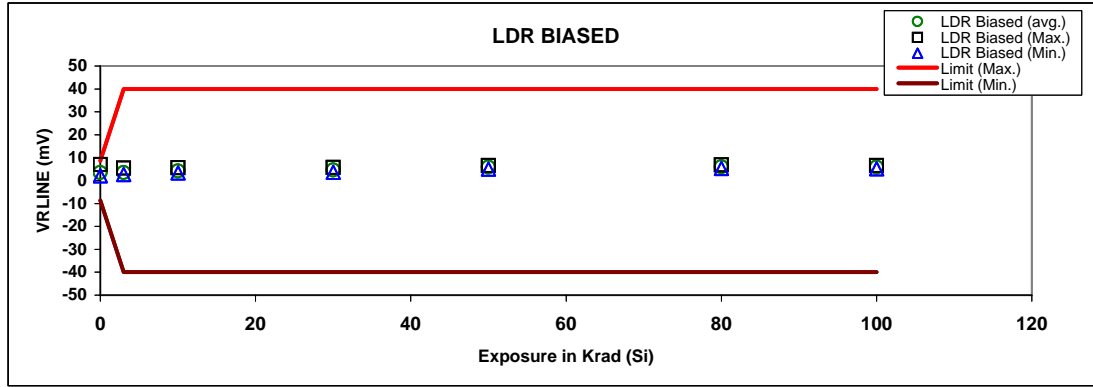

LM117HVHRLQMLV Radiation Data

TEST ID 1200 - VRLINE; 40V<=VDIFF<=60 V, IL=8MA (MV)

TEST_BIAS	DOSE (k)	OBS	AVG	MEDIAN	MAX	MIN	SIGMA	UTL	LTL	Median Delta (from 0 rad)	Delta Ratio (to HDR)	Max Unit Delta
LDR_bias	0	15	4.58603	4.45557	6.47736	3.43323	0.92628	25	-25	0		
LDR_bias	3	15	3.53069	3.17478	6.27613	2.63309	1.03832	25	-25	-1.28079		
LDR_bias	10	15	3.09722	3.05176	3.68309	2.70844	0.249687	25	-25	-1.40381		
LDR_bias	30	15	3.08921	3.06225	3.49522	2.66361	0.233819	25	-25	-1.39332		
LDR_bias	50	15	3.43876	3.43323	3.82423	3.00026	0.195794	25	-25	-1.02234		
LDR_bias	80	15	3.44308	3.45612	3.78704	3.12042	0.168993	25	-25	-0.99945		
LDR_bias	100	15	3.37283	3.37791	3.77178	3.14713	0.160977	25	-25	-1.07766	2.10	
LDR_unbias	0	15	4.72342	4.43649	6.36959	3.59535	0.848523	25	-25	0		
LDR_unbias	3	15	5.07342	4.94099	6.89507	3.34644	0.991341	25	-25	0.5045		
LDR_unbias	10	15	4.56123	3.94154	7.75719	3.11279	1.56019	25	-25	-0.49495		
LDR_unbias	30	15	4.0493	3.52859	8.09002	3.08132	1.42075	25	-25	-0.9079		
LDR_unbias	50	15	4.71236	4.52709	6.3715	4.30298	0.523973	25	-25	0.0906		
LDR_unbias	80	15	5.72135	5.4636	7.01904	5.22709	0.54373	25	-25	1.02711		
LDR_unbias	100	15	6.12335	6.10352	7.02953	5.49507	0.489492	25	-25	1.66703	-1.86	
HDR_bias	0	18	4.65976	4.45986	6.93321	2.75707	1.27523	25	-25	0		
HDR_bias	3	18	3.84045	3.66735	5.55515	2.65121	0.978447	25	-25	-0.79251		
HDR_bias	10	18	3.31084	2.88057	5.40924	2.44236	0.928497	25	-25	-1.57929		
HDR_bias	30	18	2.93366	2.86102	3.72887	2.71893	0.24329	25	-25	-1.59884		
HDR_bias	50	18	3.07088	3.08514	3.27015	2.85149	0.106779	25	-25	-1.37472		
HDR_bias	80	18	3.51938	3.5429	3.7384	3.13663	0.143015	25	-25	-0.91696		
HDR_bias	100	18	3.96543	3.94726	4.33636	3.71075	0.193388	25	-25	-0.5126		
HDR_unbias	0	15	4.96432	4.90189	7.19166	2.05231	1.24031	25	-25	0		
HDR_unbias	3	15	5.02726	4.90475	7.02858	2.60448	1.12451	25	-25	0.00286		
HDR_unbias	10	15	4.53904	4.86469	6.60801	2.76661	1.23539	25	-25	-0.0372		
HDR_unbias	30	15	4.15942	3.80611	7.2813	2.85053	1.39414	25	-25	-1.09578		
HDR_unbias	50	15	3.85386	3.44658	7.14874	2.89059	1.14441	25	-25	-1.45531		
HDR_unbias	80	15	3.9334	3.81565	5.69344	3.18623	0.582916	25	-25	-1.08624		
HDR_unbias	100	15	4.00734	4.00639	4.44412	3.66211	0.216887	25	-25	-0.8955		

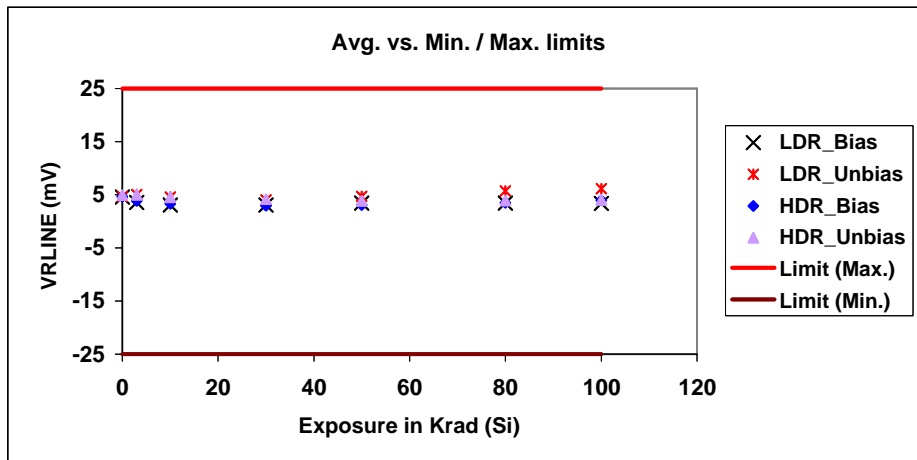

LM117HVHRLQMLV Radiation Data

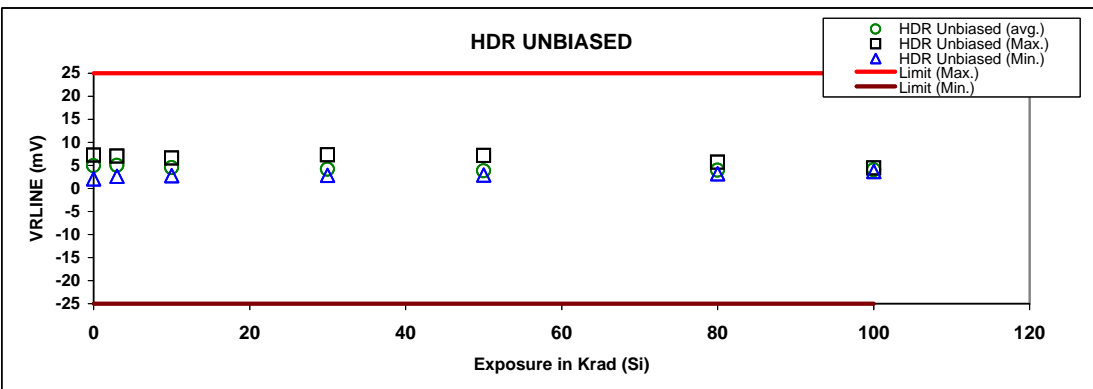
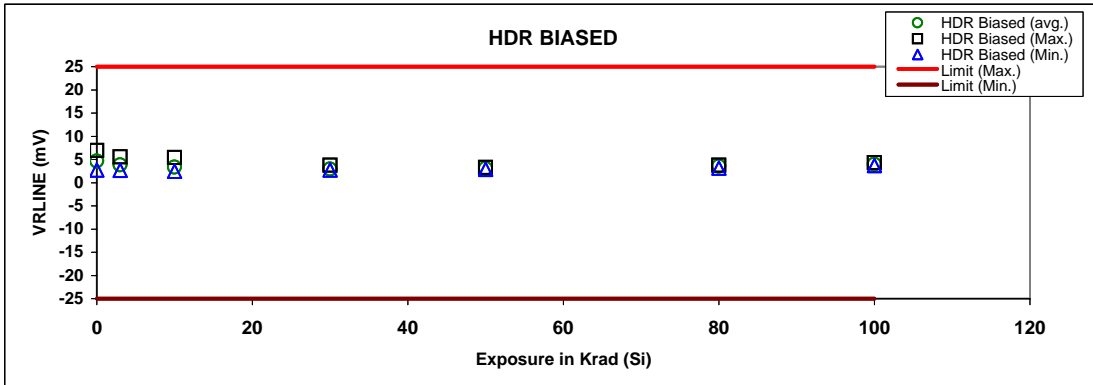
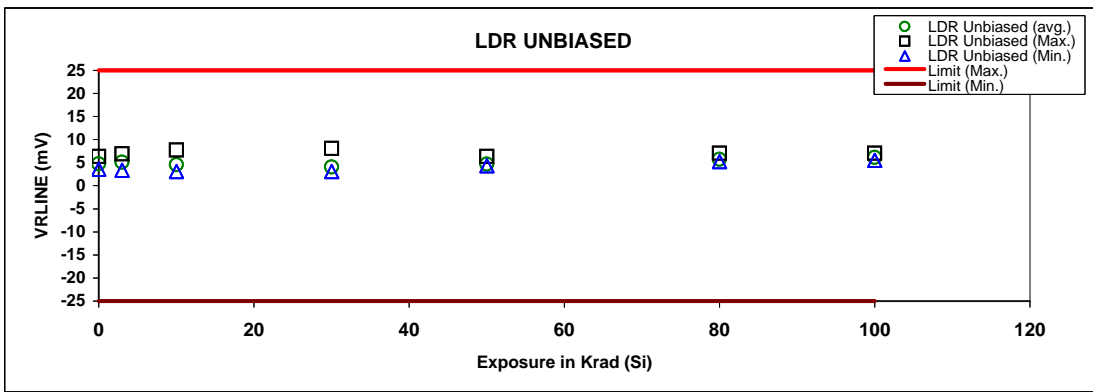
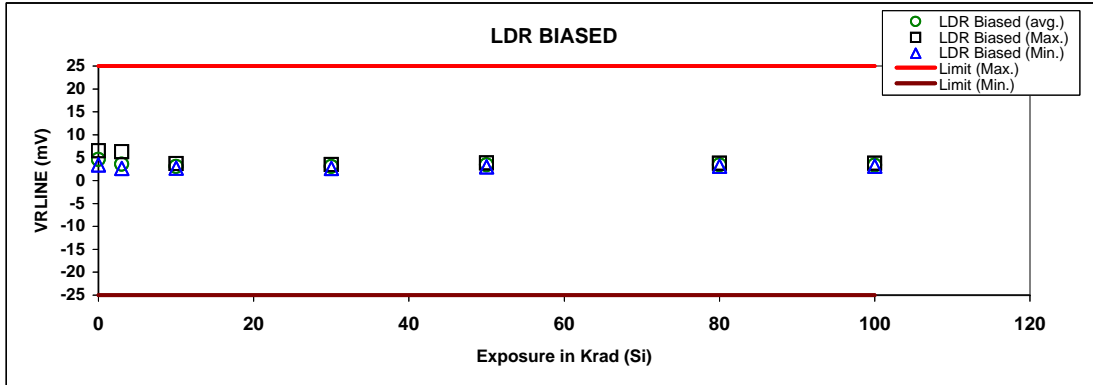

LM117HVHRLQMLV Radiation Data

TEST ID 1300 - VRLOAD; VDIFF=3 V, 10MA<=IL<=500MA (MV)

TEST_BIAS	DOSE (k)	OBS	AVG	MEDIAN	MAX	MIN	SIGMA	UTL	LTL	Median Delta (from 0 rad)	Delta Ratio (to HDR)	Max Unit Delta
LDR_bias	0	15	10.6225	11.1694	12.2652	7.72379	1.49562	15	-15	0		
LDR_bias	3	15	10.7465	10.6535	13.9541	8.09	1.95501	27	-27	-0.5159		
LDR_bias	10	15	10.4585	9.88196	12.7811	8.54586	1.40993	27	-27	-1.28744		
LDR_bias	30	15	9.36558	9.20485	12.3348	8.03088	0.946399	27	-27	-1.96455		
LDR_bias	50	15	10.2753	9.62351	13.133	8.23019	1.69257	27	-27	-1.54589		
LDR_bias	80	15	10.0372	9.54722	13.0682	8.16439	1.47632	27	-27	-1.62218		
LDR_bias	100	15	10.0848	9.79517	12.9824	8.29886	1.33607	27	-27	-1.37423	-2.93	
LDR_unbias	0	15	10.7581	11.1141	13.5555	8.69845	1.6088	15	-15	0		
LDR_unbias	3	15	10.4425	10.6172	13.6804	7.11535	2.07211	27	-27	-0.4969		
LDR_unbias	10	15	10.8543	10.663	13.134	7.68755	1.58366	27	-27	-0.4511		
LDR_unbias	30	15	10.6646	10.0345	14.0314	8.35894	1.90779	27	-27	-1.0796		
LDR_unbias	50	15	11.6106	11.1761	14.8125	9.48046	1.66739	27	-27	0.062		
LDR_unbias	80	15	12.5693	11.4937	16.4823	10.3683	2.00888	27	-27	0.3796		
LDR_unbias	100	15	13.6951	13.9351	16.5853	10.7679	1.91912	27	-27	2.821	-7.49	6.08
HDR_bias	0	18	11.203	11.8933	13.134	8.43142	1.53879	15	-15	0		
HDR_bias	3	18	11.4265	11.9333	12.8679	8.09954	1.28584	27	-27	0.04		
HDR_bias	10	18	11.3381	12.124	13.1264	7.65036	1.73869	27	-27	0.2307		
HDR_bias	30	18	11.2512	11.9858	13.2103	7.99178	1.6144	27	-27	0.0925		
HDR_bias	50	18	11.1925	11.8241	13.0882	8.35608	1.61782	27	-27	-0.0692		
HDR_bias	80	18	11.8067	12.3286	13.3629	8.62502	1.48214	27	-27	0.4353		
HDR_bias	100	18	11.8979	12.362	13.4773	9.61493	1.29606	27	-27	0.4687		
HDR_unbias	0	15	11.9658	12.0935	12.9804	9.89054	0.895572	15	-15	0		
HDR_unbias	3	15	11.2776	12.0268	13.7348	8.80335	1.58085	27	-27	-0.0667		
HDR_unbias	10	15	10.6417	10.3788	14.7638	8.18537	1.83608	27	-27	-1.7147		
HDR_unbias	30	15	11.8158	12.2757	14.1458	9.20294	1.32474	27	-27	0.1822		
HDR_unbias	50	15	11.4227	11.322	13.4582	8.91589	1.32989	27	-27	-0.7715		
HDR_unbias	80	15	11.8158	11.4918	14.1458	9.20294	1.32474	27	-27	-0.6017		
HDR_unbias	100	15	12.1369	11.7168	14.8411	8.91207	1.61609	27	-27	-0.3767		

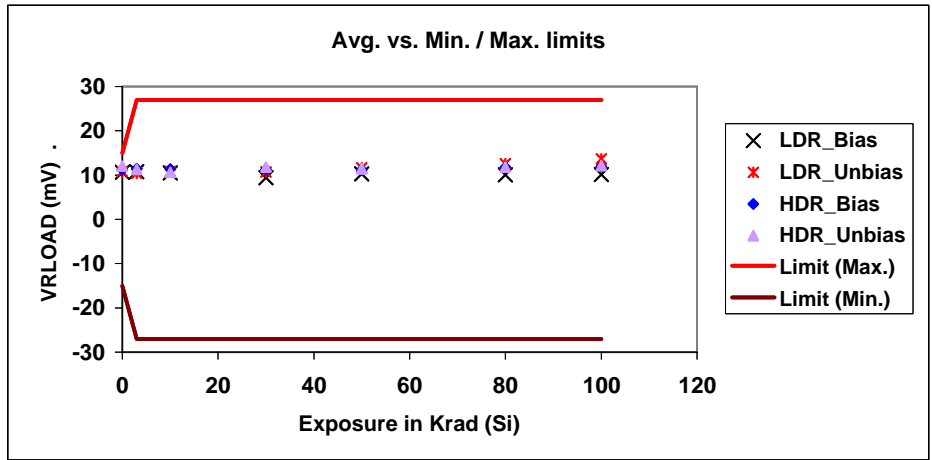

LM117HVHRLQMLV Radiation Data

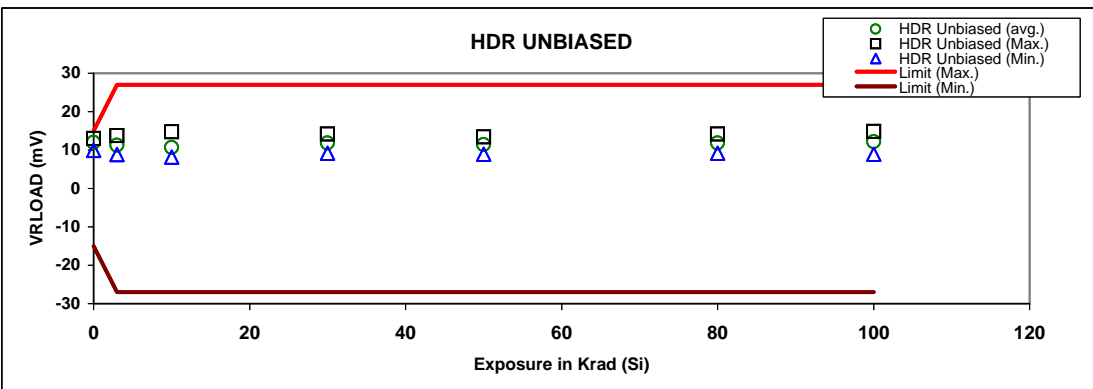
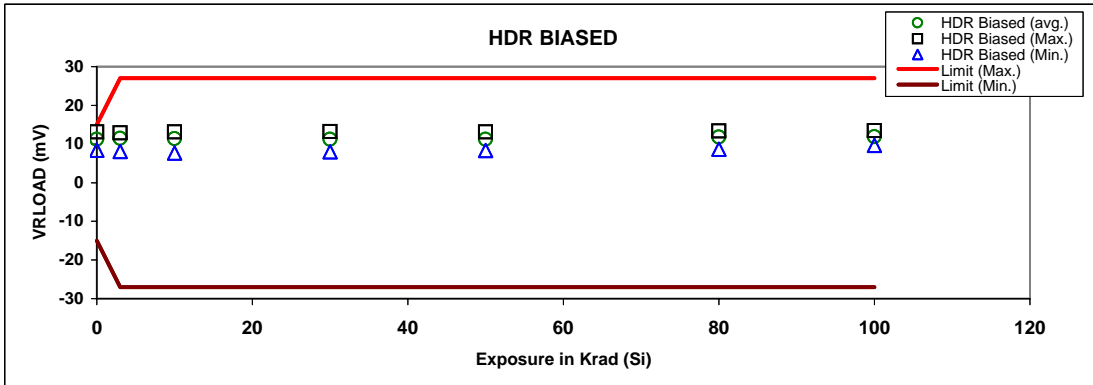
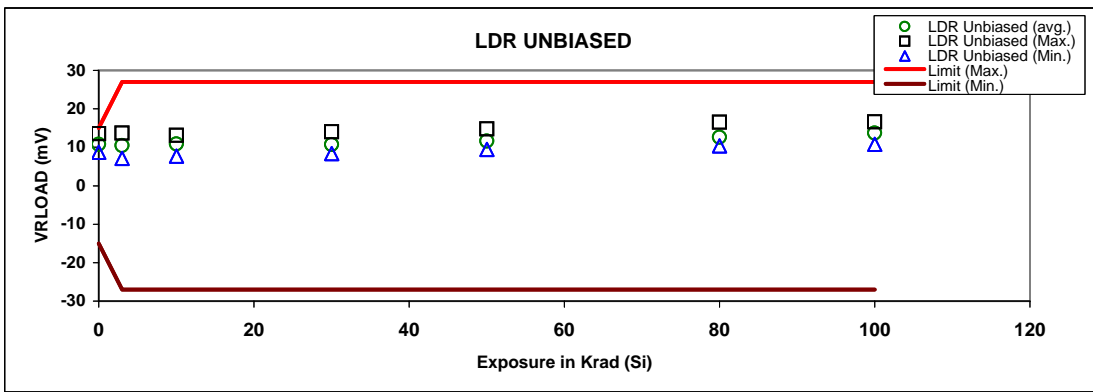
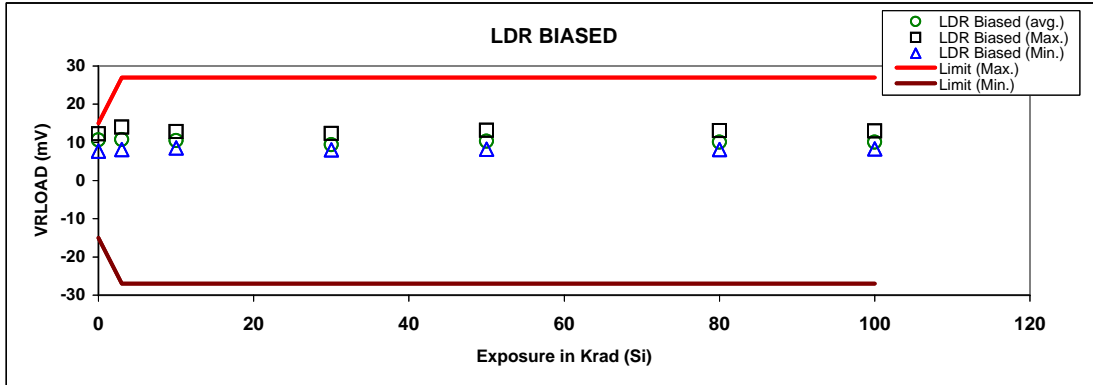

LM117HVHRLQMLV Radiation Data

TEST ID 1400 - VRLOAD; VDIFF=40 V, 10MA<=IL<=150MA (MV)

TEST_BIAS	DOSE (k)	OBS	AVG	MEDIAN	MAX	MIN	SIGMA	UTL	LTL	Median Delta (from 0 rad)	Delta Ratio (to HDR)	Max Unit Delta
LDR_bias	0	15	-5.00565	-5.16033	-4.1666	-5.47504	0.45537	15	-15	0		
LDR_bias	3	15	-5.06852	-4.92191	-4.35829	-5.93472	0.539726	15	-15	0.23842		
LDR_bias	10	15	-4.93476	-4.81701	-4.33826	-5.64766	0.380295	15	-15	0.34332		
LDR_bias	30	15	-4.6587	-4.73022	-4.29535	-5.54276	0.284597	15	-15	0.43011		
LDR_bias	50	15	-4.91333	-4.73022	-4.27151	-5.65147	0.46591	15	-15	0.43011		
LDR_bias	80	15	-4.87213	-4.69208	-4.22382	-5.75066	0.45367	15	-15	0.46825		
LDR_bias	100	15	-4.86164	-4.8542	-4.31252	-5.66673	0.376484	15	-15	0.30613	-2.78	
LDR_unbias	0	15	-5.06674	-5.17941	-4.41742	-5.95093	0.481302	15	-15	0		
LDR_unbias	3	15	-5.00863	-5.02682	-3.81374	-6.03771	0.611051	15	-15	0.15259		
LDR_unbias	10	15	-5.12066	-5.08595	-4.27437	-5.79166	0.444144	15	-15	0.09346		
LDR_unbias	30	15	-5.07056	-4.7884	-4.43459	-6.02055	0.58544	15	-15	0.39101		
LDR_unbias	50	15	-5.39646	-5.34916	-4.74739	-6.34098	0.487113	15	-15	-0.16975		
LDR_unbias	80	15	-5.73864	-5.34916	-5.04398	-7.10773	0.642568	15	-15	-0.16975		
LDR_unbias	100	15	-6.14726	-6.10447	-5.20611	-7.05719	0.539599	15	-15	-0.92506	-9.80	
HDR_bias	0	18	-5.18703	-5.35536	-4.40788	-5.6572	0.440992	15	-15	0		
HDR_bias	3	18	-5.24176	-5.34439	-4.26388	-5.62668	0.362717	15	-15	0.01097		
HDR_bias	10	18	-5.22227	-5.35965	-4.27341	-5.84602	0.486012	15	-15	-0.00429		
HDR_bias	30	18	-5.18476	-5.41258	-4.34875	-5.74112	0.46914	15	-15	-0.05722		
HDR_bias	50	18	-5.15514	-5.31816	-4.3869	-5.80883	0.451263	15	-15	0.0372		
HDR_bias	80	18	-5.39621	-5.5275	-4.49181	-5.87559	0.451435	15	-15	-0.17214		
HDR_bias	100	18	-5.36426	-5.46551	-4.69494	-5.95188	0.392838	15	-15	-0.11015		
HDR_unbias	0	15	-5.41064	-5.47409	-4.78745	-5.64575	0.260545	15	-15	0		
HDR_unbias	3	15	-5.14692	-5.30148	-4.39835	-5.99003	0.462049	15	-15	0.17261		
HDR_unbias	10	15	-5.03527	-4.87328	-4.19712	-6.2685	0.543914	15	-15	0.60081		
HDR_unbias	30	15	-5.34159	-5.3587	-4.64439	-5.85747	0.335746	15	-15	0.11539		
HDR_unbias	50	15	-5.27795	-5.33962	-4.66537	-5.8651	0.383755	15	-15	0.13447		
HDR_unbias	80	15	-5.27662	-5.21183	-4.73976	-5.90706	0.396467	15	-15	0.26226		
HDR_unbias	100	15	-5.45216	-5.37968	-4.45271	-6.19602	0.456925	15	-15	0.09441		

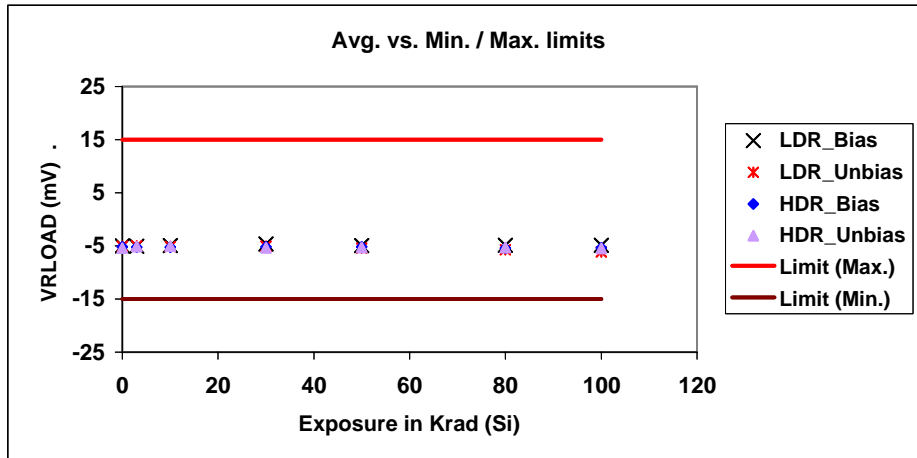

LM117HVHRLQMLV Radiation Data

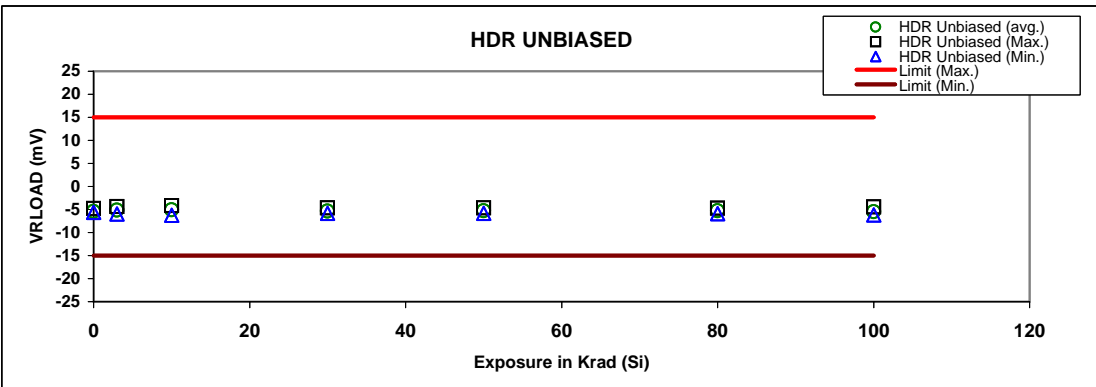
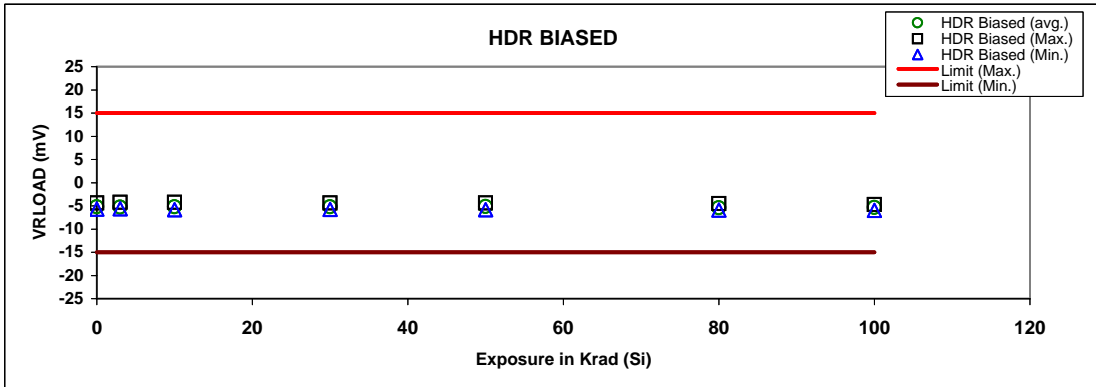
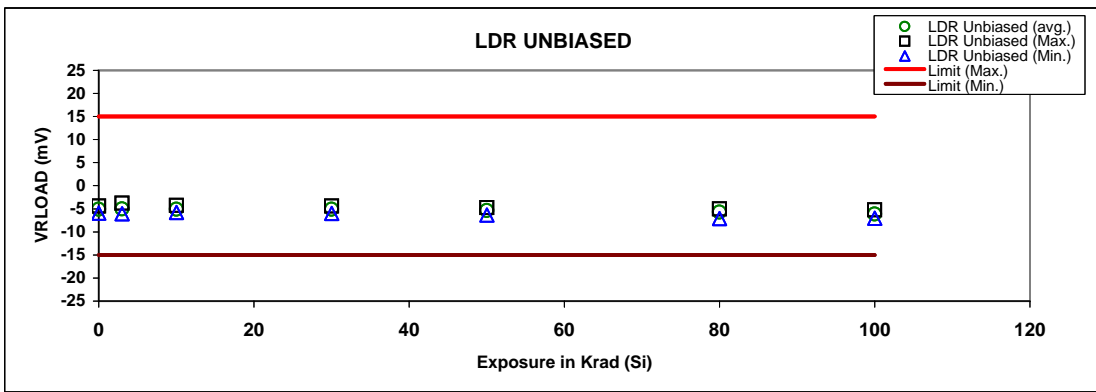
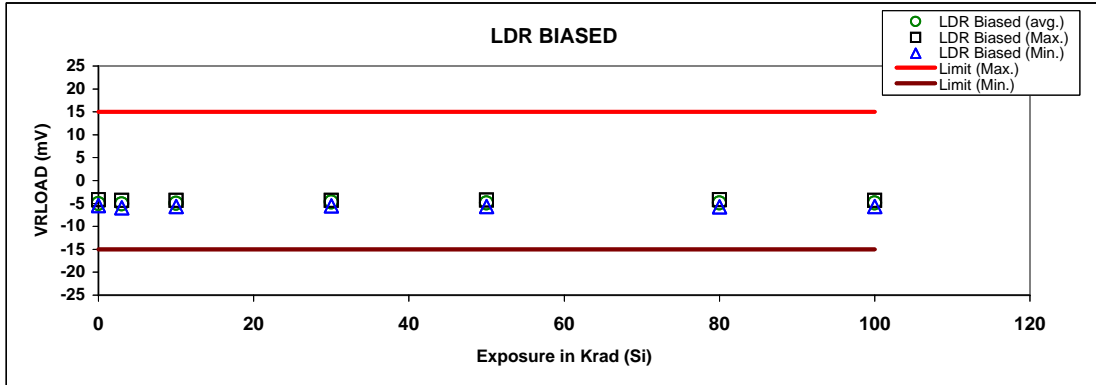

LM117HVHRLQMLV Radiation Data

TEST ID 1500 - VRTH; VDIFF=40 V, IL=150MA, T=20MS (MV)

TEST_BIAS	DOSE (k)	OBS	AVG	MEDIAN	MAX	MIN	SIGMA	UTL	LTL	Median Delta (from 0 rad)	Delta Ratio (to HDR)	Max Unit Delta
LDR_bias	0	15	0.967957	3.27301	0.991283	0.952752	0.0105863	6	-6	0		
LDR_bias	3	15	0.976515	3.39699	1.00215	0.961943	0.0115382	6	-6	0.12398		
LDR_bias	10	15	0.98913	3.33786	1.0074	0.974397	0.0095323	6	-6	0.06485		
LDR_bias	30	15	0.993825	3.30925	1.00971	0.977065	0.00983251	6	-6	0.03624		
LDR_bias	50	15	1.01584	3.24821	1.04151	0.994664	0.0119018	6	-6	-0.0248		
LDR_bias	80	15	1.01394	3.28255	1.04687	0.988525	0.014477	6	-6	0.00954		
LDR_bias	100	15	1.0093	3.3474	1.04327	0.984627	0.0147521	6	-6	0.07439	-0.31	
LDR_unbias	0	15	0.966124	3.35693	0.97806	0.949374	0.00986627	6	-6	0		
LDR_unbias	3	15	0.97243	3.29018	0.987447	0.953632	0.0106586	6	-6	-0.06675		
LDR_unbias	10	15	0.982847	3.24345	0.997426	0.960655	0.012172	6	-6	-0.11348		
LDR_unbias	30	15	0.995851	3.1662	1.01377	0.969638	0.0133735	6	-6	-0.19073		
LDR_unbias	50	15	1.0215	3.01456	1.03798	0.996298	0.0137181	6	-6	-0.34237		
LDR_unbias	80	15	1.02062	2.58541	1.03564	0.98528	0.014642	6	-6	-0.77152		
LDR_unbias	100	15	1.01588	2.58541	1.03122	0.980863	0.0137592	6	-6	-0.77152	1.62	
HDR_bias	0	18	3.30814	3.30067	3.87287	2.75707	0.261244	6	-6	0		
HDR_bias	3	18	0.970643	3.18623	0.991605	0.949684	0.0114434	6	-6	-0.11444		
HDR_bias	10	18	3.21484	3.2053	3.76987	2.47288	0.273374	6	-6	-0.09537		
HDR_bias	30	18	3.22119	3.19576	3.78609	2.52724	0.289993	6	-6	-0.10491		
HDR_bias	50	18	3.1884	3.17669	3.63636	2.61402	0.257612	6	-6	-0.12398		
HDR_bias	80	18	3.02325	3.00837	3.48091	2.33841	0.267504	6	-6	-0.2923		
HDR_bias	100	18	3.0534	3.06129	3.54958	2.27165	0.284585	6	-6	-0.23938		
HDR_unbias	0	15	0.972563	3.40462	0.983939	0.956379	0.00942442	6	-6	0		
HDR_unbias	3	15	0.973116	3.33786	0.984723	0.956302	0.00961409	6	-6	-0.06676		
HDR_unbias	10	15	0.97516	3.29018	0.986602	0.959047	0.00955071	6	-6	-0.11444		
HDR_unbias	30	15	0.980797	3.35598	0.994376	0.961326	0.0101468	6	-6	-0.04864		
HDR_unbias	50	15	0.98524	3.20339	0.9995	0.967123	0.00982731	6	-6	-0.20123		
HDR_unbias	80	15	0.991388	3.13282	1.00758	0.972786	0.0100814	6	-6	-0.2718		
HDR_unbias	100	15	0.992878	2.92873	1.01011	0.975243	0.0104098	6	-6	-0.47589		

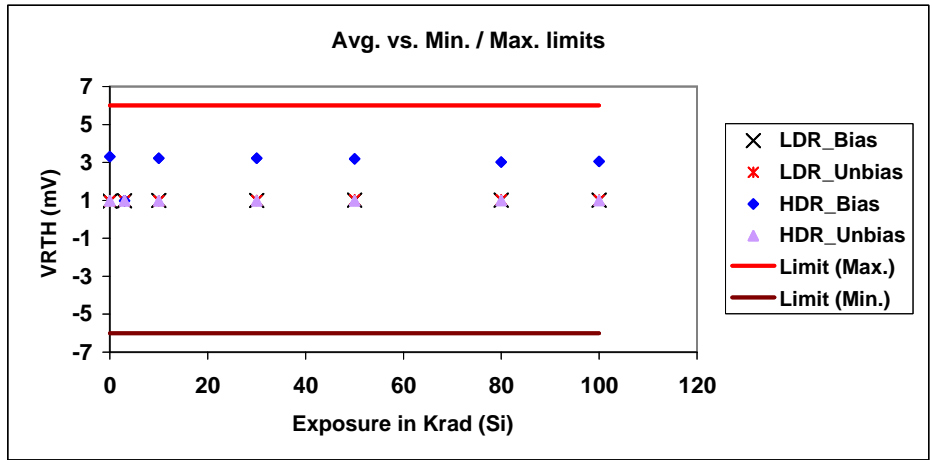

LM117HVHRLQMLV Radiation Data

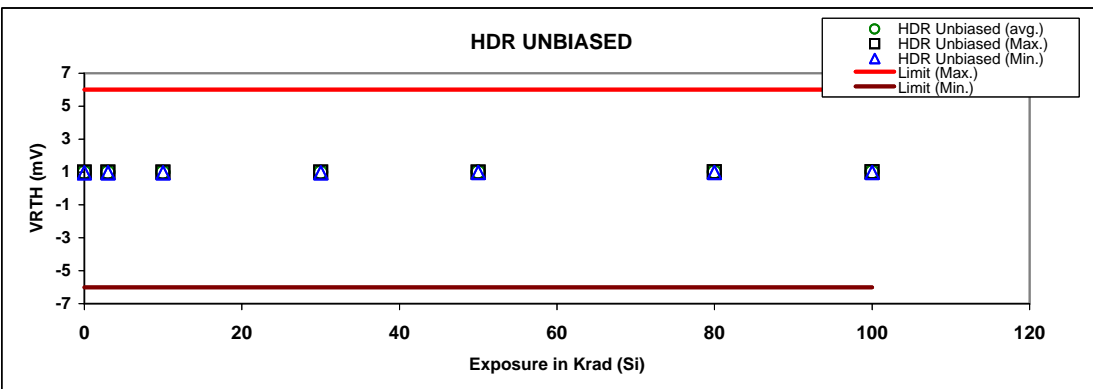
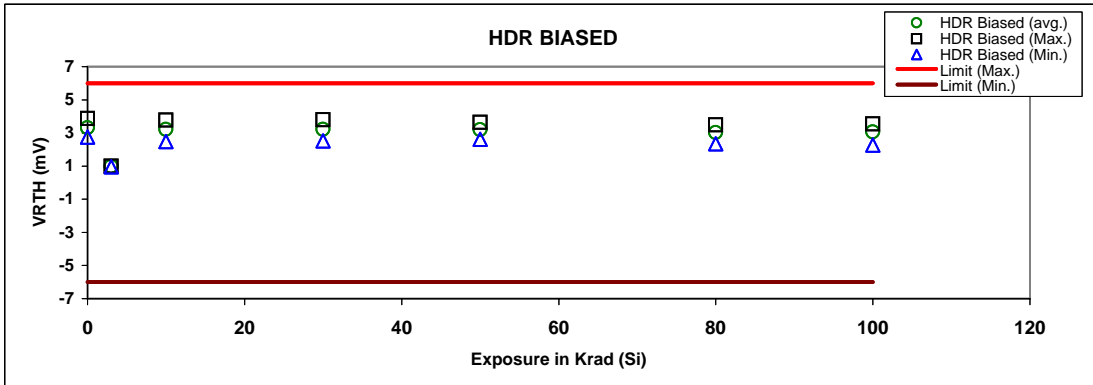
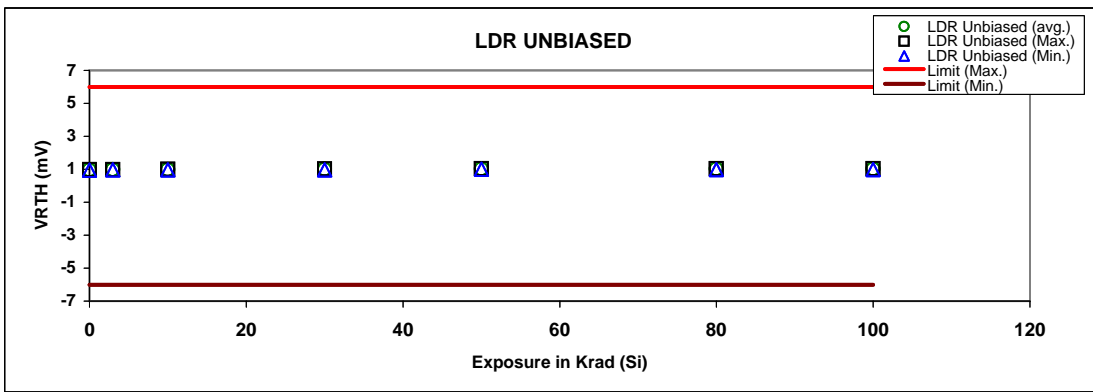
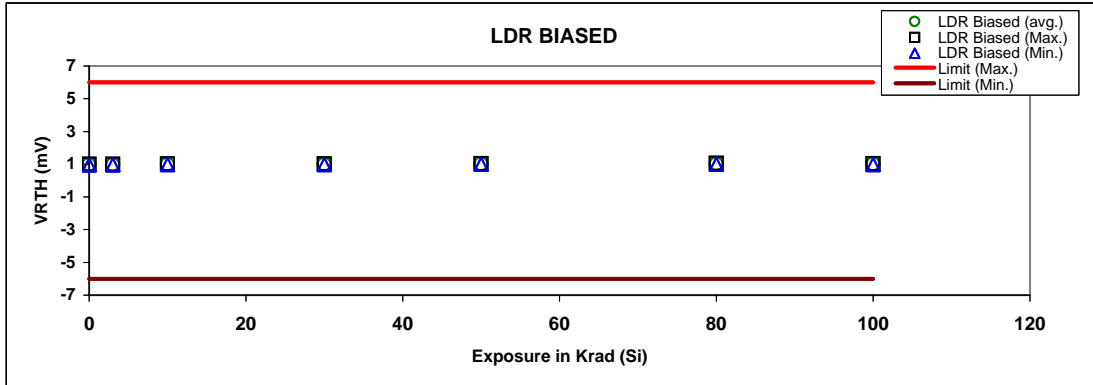

LM117HVHRLQMLV Radiation Data

TEST ID 1600 - ISC; $V_{IN}=4.25\text{ V (A)}$

TEST_BIAS	DOSE (k)	OBS	AVG	MEDIAN	MAX	MIN	SIGMA	UTL	LTL	Median Delta (from 0 rad)	Delta Ratio (to HDR)	Max Unit Delta
LDR_bias	0	15	0.967957	0.968716	0.991283	0.952752	0.0105863	1.8	0.5	0		
LDR_bias	3	15	0.976515	0.976319	1.00215	0.961943	0.0115382	1.8	0.5	0.007603		
LDR_bias	10	15	0.98913	0.990134	1.0074	0.974397	0.0095323	1.8	0.5	0.021418		
LDR_bias	30	15	0.993825	0.994508	1.00971	0.977065	0.00983251	1.8	0.5	0.025792		
LDR_bias	50	15	1.01584	1.01555	1.04151	0.994664	0.0119018	1.8	0.5	0.046834		
LDR_bias	80	15	1.01394	1.01441	1.04687	0.988525	0.014477	1.8	0.5	0.045694		
LDR_bias	100	15	1.0093	1.00618	1.04327	0.984627	0.0147521	1.8	0.5	0.037464	2.53	
LDR_unbias	0	15	0.966124	0.967816	0.97806	0.949374	0.00986627	1.8	0.5	0		
LDR_unbias	3	15	0.97243	0.975089	0.987447	0.953632	0.0106586	1.8	0.5	0.007273		
LDR_unbias	10	15	0.982847	0.985221	0.997426	0.960655	0.012172	1.8	0.5	0.017405		
LDR_unbias	30	15	0.995851	0.996104	1.01377	0.969638	0.0133735	1.8	0.5	0.028288		
LDR_unbias	50	15	1.0215	1.02489	1.03798	0.996298	0.0137181	1.8	0.5	0.057074		
LDR_unbias	80	15	1.02062	1.02694	1.03564	0.98528	0.014642	1.8	0.5	0.059124		
LDR_unbias	100	15	1.01588	1.02309	1.03122	0.980863	0.0137592	1.8	0.5	0.055274	2.47	
HDR_bias	0	18	0.970968	0.969301	0.991816	0.9545	0.0100953	1.8	0.5	0		
HDR_bias	3	18	0.970643	0.969801	0.991605	0.949684	0.0114434	1.8	0.5	0.0005		
HDR_bias	10	18	0.972485	0.969484	0.993215	0.95375	0.0101549	1.8	0.5	0.000183		
HDR_bias	30	18	0.975424	0.973292	0.995367	0.96008	0.0104198	1.8	0.5	0.003991		
HDR_bias	50	18	0.977741	0.97824	1.00112	0.948454	0.0131818	1.8	0.5	0.008939		
HDR_bias	80	18	0.978264	0.980312	1.00872	0.93397	0.0168164	1.8	0.5	0.011011		
HDR_bias	100	18	0.981472	0.984115	1.01524	0.93211	0.0182787	1.8	0.5	0.014814		
HDR_unbias	0	15	0.972563	0.970714	0.983939	0.956379	0.00942442	1.8	0.5	0		
HDR_unbias	3	15	0.973116	0.971652	0.984723	0.956302	0.00961409	1.8	0.5	0.000938		
HDR_unbias	10	15	0.97516	0.974397	0.986602	0.959047	0.00955071	1.8	0.5	0.003683		
HDR_unbias	30	15	0.980797	0.980382	0.994376	0.961326	0.0101468	1.8	0.5	0.009668		
HDR_unbias	50	15	0.98524	0.985376	0.9995	0.967123	0.00982731	1.8	0.5	0.014662		
HDR_unbias	80	15	0.991388	0.991727	1.00758	0.972786	0.0100814	1.8	0.5	0.021013		
HDR_unbias	100	15	0.992878	0.993049	1.01011	0.975243	0.0104098	1.8	0.5	0.022335		

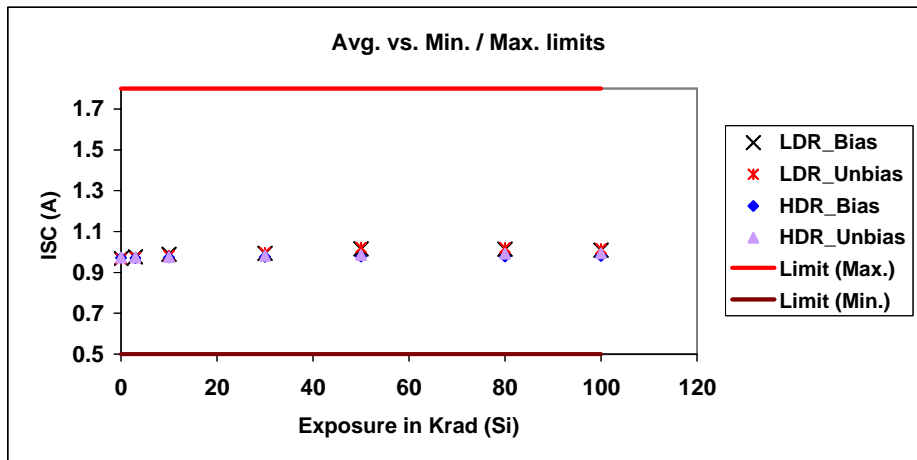

LM117HVHRLQMLV Radiation Data

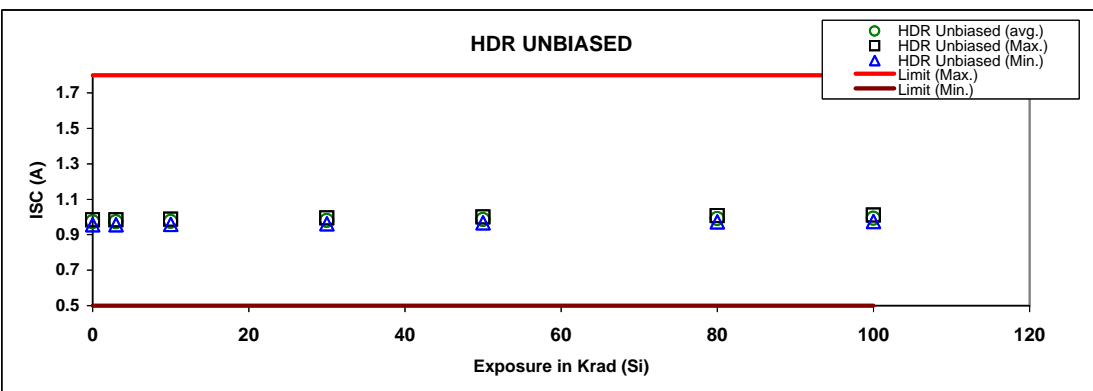
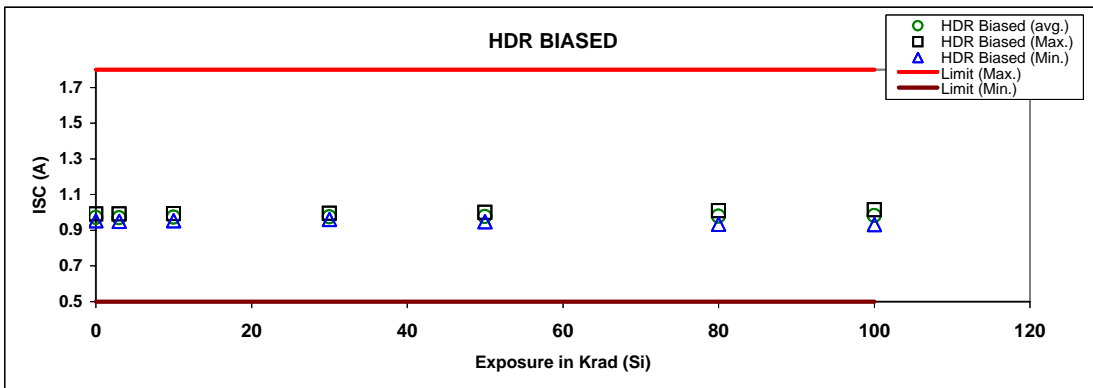
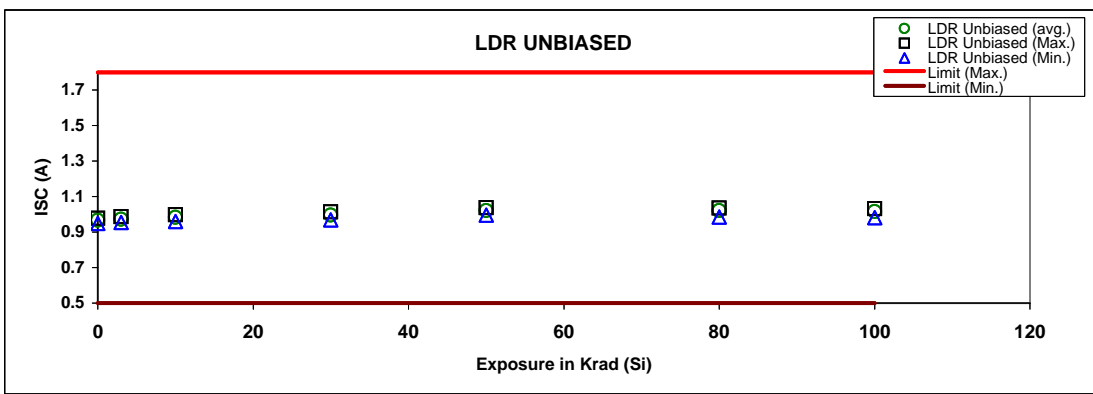
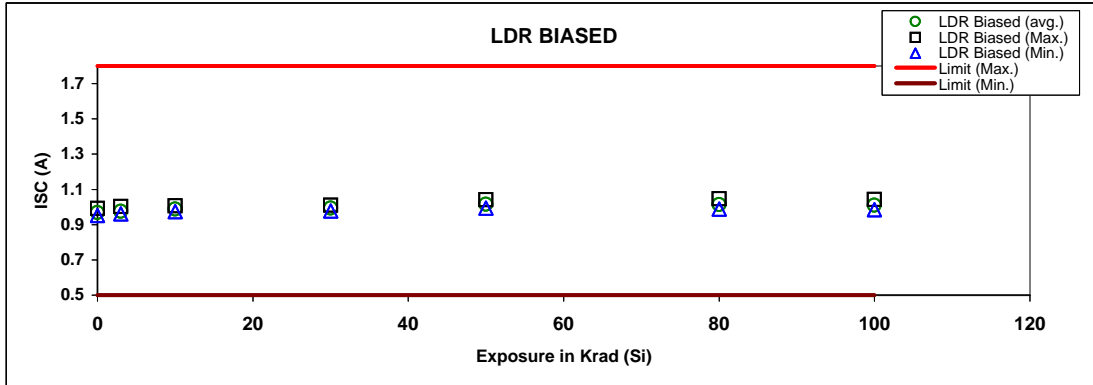

LM117HVHRLQMLV Radiation Data

TEST ID 1700 - ISC; V_{IN}=60 V (A)

TEST_BIAS	DOSE (k)	OBS	AVG	MEDIAN	MAX	MIN	SIGMA	UTL	LTL	Median Delta (from 0 rad)	Delta Ratio (to HDR)	Max Unit Delta
LDR_bias	0	15	0.0471093	0.041361	0.0658696	0.0392164	0.0110808	0.4	0	0		
LDR_bias	3	15	0.0483042	0.0436868	0.0639132	0.0423605	0.00879066	0.4	0	0.0023258		
LDR_bias	10	15	0.0523235	0.0487681	0.0637786	0.0461238	0.00657651	0.4	0	0.0074071		
LDR_bias	30	15	0.0532879	0.0502866	0.0641159	0.0470615	0.0057707	0.4	0	0.0089256		
LDR_bias	50	15	0.0635048	0.0629838	0.0699497	0.0585129	0.0033909	0.4	0	0.0216228		
LDR_bias	80	15	0.0670259	0.0669741	0.0716606	0.0633491	0.00247681	0.4	0	0.0256131		
LDR_bias	100	15	0.0677558	0.0674931	0.0719641	0.0647483	0.00215982	0.4	0	0.0261321	1.26	
LDR_unbias	0	15	0.0424734	0.0411345	0.0644163	0.0391588	0.00605712	0.4	0	0		
LDR_unbias	3	15	0.0446687	0.0432255	0.0680568	0.0410383	0.00654622	0.4	0	0.002091		
LDR_unbias	10	15	0.0472848	0.0469078	0.0502866	0.0453742	0.00160486	0.4	0	0.0057733		
LDR_unbias	30	15	0.0528563	0.0518243	0.0708205	0.0480954	0.00544972	0.4	0	0.0106898		
LDR_unbias	50	15	0.0645681	0.0631953	0.0773192	0.060585	0.00424372	0.4	0	0.0220608		
LDR_unbias	80	15	0.0727844	0.0726368	0.0805255	0.0688155	0.00354139	0.4	0	0.0315023		
LDR_unbias	100	15	0.0761357	0.0765502	0.0814056	0.0719448	0.00311674	0.4	0	0.0354157	1.96	
HDR_bias	0	18	0.0412751	0.0412669	0.0436498	0.0398873	0.00099689	0.4	0	0		
HDR_bias	3	18	0.0415832	0.0417666	0.043938	0.0394109	0.00108546	0.4	0	0.0004997		
HDR_bias	10	18	0.0430483	0.0430156	0.0456443	0.0417666	0.00106404	0.4	0	0.0017487		
HDR_bias	30	18	0.0474288	0.0472354	0.0499409	0.0460287	0.00117151	0.4	0	0.0059685		
HDR_bias	50	18	0.0521601	0.0520988	0.0548524	0.0497103	0.00134854	0.4	0	0.0108319		
HDR_bias	80	18	0.0579111	0.0577982	0.0612781	0.0544489	0.00174033	0.4	0	0.0165313		
HDR_bias	100	18	0.0619663	0.0620852	0.0652904	0.0577694	0.0019136	0.4	0	0.0208183		
HDR_unbias	0	15	0.0414458	0.0416208	0.0437162	0.0392453	0.00123204	0.4	0	0		
HDR_unbias	3	15	0.041817	0.0420245	0.0433317	0.0397259	0.00109149	0.4	0	0.0004037		
HDR_unbias	10	15	0.0428273	0.0427934	0.0446389	0.0409136	0.00105103	0.4	0	0.0011726		
HDR_unbias	30	15	0.046405	0.0460958	0.0490672	0.0443506	0.00129509	0.4	0	0.004475		
HDR_unbias	50	15	0.0502044	0.0495094	0.0530809	0.0481829	0.00168329	0.4	0	0.0078886		
HDR_unbias	80	15	0.0562113	0.0556678	0.0587395	0.0538072	0.00180539	0.4	0	0.014047		
HDR_unbias	100	15	0.0593752	0.0596815	0.0616766	0.0566675	0.00165338	0.4	0	0.0180607		

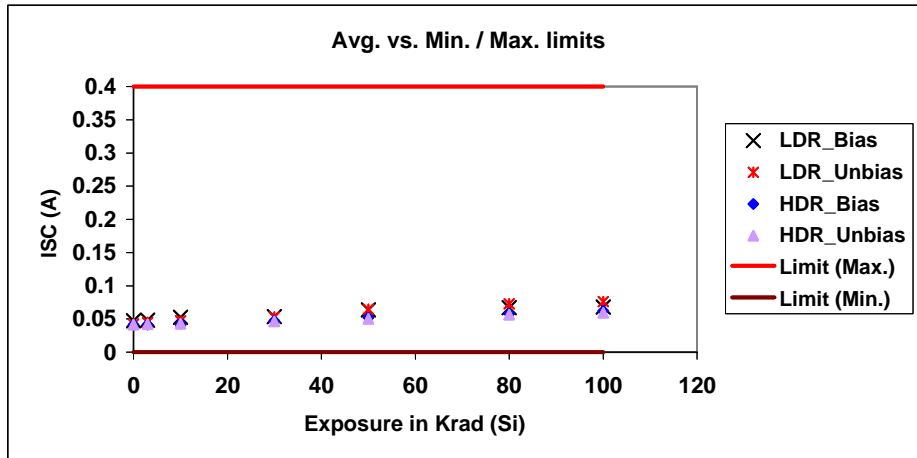

LM117HVHRLQMLV Radiation Data

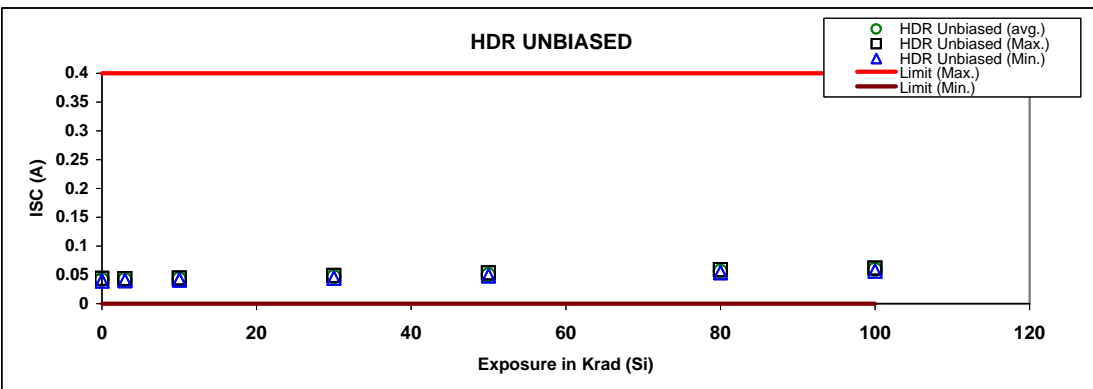
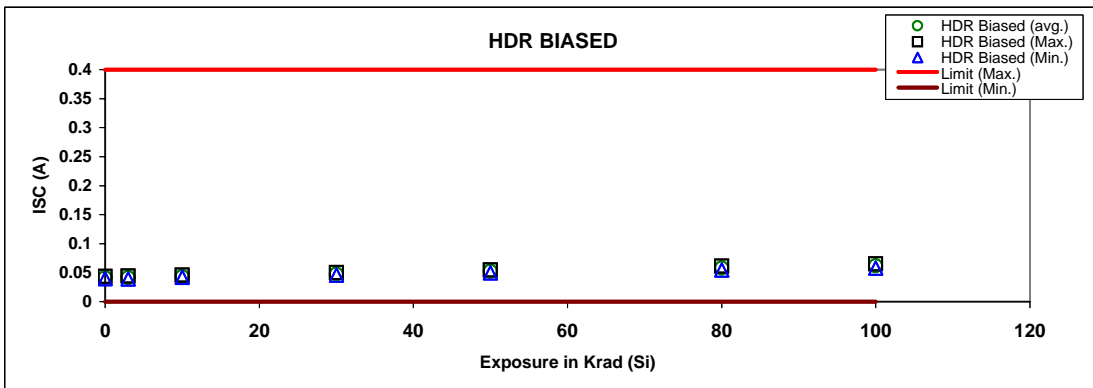
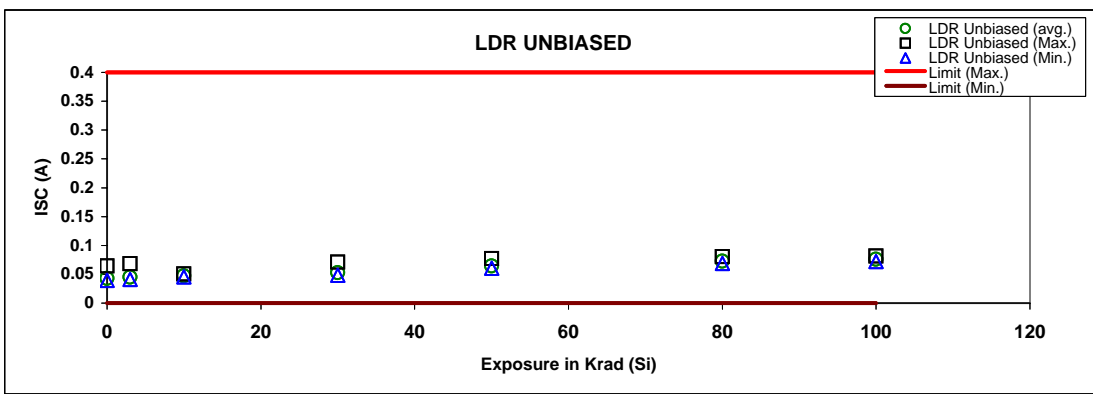
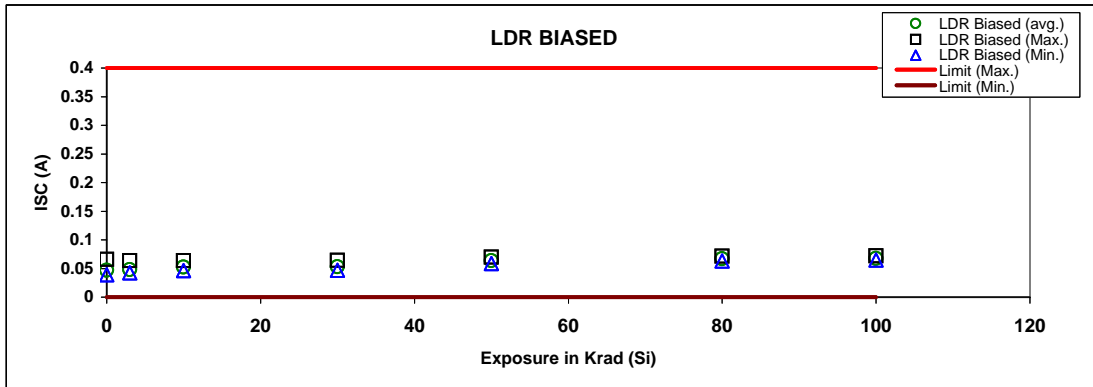

LM117HVHRLQMLV Radiation Data

TEST ID 10100 - RIPPLE REJECTION; 120 Hz, 1 V RMS (dB)

TEST_BIAS	DOSE (k)	OBS	AVG	MEDIAN	MAX	MIN	SIGMA	UTL	LTL	Median Delta (from 0 rad)	Delta Ratio (to HDR)	Max Unit Delta
LDR_bias	0	15	77.0555	80.5897	80.9447	66.9133	6.1777	-	66	0		
LDR_bias	3	15	75.2571	76.8513	78.4791	69.4922	3.36174	-	55	-3.7384		
LDR_bias	10	15	72.6628	73.1095	75.6433	69.3362	1.91082	-	55	-7.4802		
LDR_bias	30	15	71.625	71.9801	74.5451	68.8043	1.61674	-	55	-8.6096		
LDR_bias	50	15	68.6613	68.6763	70.3914	67.3361	0.889604	-	55	-11.9134		
LDR_bias	80	15	68.4246	68.5291	69.7576	67.1363	0.775828	-	55	-12.0606		
LDR_bias	100	15	68.6417	68.7301	69.8543	67.3493	0.728599	-	55	-11.8596	1.04	
LDR_unbias	0	15	79.789	80.7409	80.9447	66.8645	3.58	-	66	0		
LDR_unbias	3	15	77.1483	78.1282	78.5175	63.5798	3.76859	-	55	-2.6127		
LDR_unbias	10	15	73.0514	73.4419	74.3268	69.8192	1.15425	-	55	-7.299		
LDR_unbias	30	15	69.0542	69.4131	71.7676	61.0976	2.54208	-	55	-11.3278		
LDR_unbias	50	15	63.4892	64.1506	64.897	58.7504	1.55994	-	55	-16.5903		
LDR_unbias	80	15	60.4492	60.9394	61.8031	57.4987	1.13383	-	55	-19.8015		
LDR_unbias	100	15	59.3631	59.8166	60.6474	57.0422	0.995391	-	55	-20.9243	1.50	
HDR_bias	0	18	80.1926	80.1467	80.6489	79.9138	0.204132	-	66	0		
HDR_bias	3	18	79.3508	79.3512	79.7318	79.0381	0.179645	-	55	-0.7955		
HDR_bias	10	18	77.9772	77.9581	78.3584	77.5748	0.179144	-	55	-2.1886		
HDR_bias	30	18	74.8683	74.8446	75.2479	74.2449	0.252353	-	55	-5.3021		
HDR_bias	50	18	72.4662	72.5567	73.1331	71.4362	0.496243	-	55	-7.59		
HDR_bias	80	18	69.8534	69.9777	70.733	68.709	0.612574	-	55	-10.169		
HDR_bias	100	18	68.5787	68.6902	69.4871	67.5162	0.617422	-	55	-11.4565		
HDR_unbias	0	15	80.3314	80.314	80.6234	79.9947	0.171661	-	66	0		
HDR_unbias	3	15	79.6957	79.6753	80.0952	79.2308	0.227945	-	55	-0.6387		
HDR_unbias	10	15	78.229	78.2204	78.8021	77.6929	0.279718	-	55	-2.0936		
HDR_unbias	30	15	74.9999	75.2055	75.8422	74.1858	0.519376	-	55	-5.1085		
HDR_unbias	50	15	72.0133	72.222	73.2371	70.8322	0.776981	-	55	-8.092		
HDR_unbias	80	15	68.4307	68.0771	70.0283	67.3137	0.856291	-	55	-12.2369		
HDR_unbias	100	15	66.7076	66.3664	68.2824	65.8496	0.833286	-	55	-13.9476		

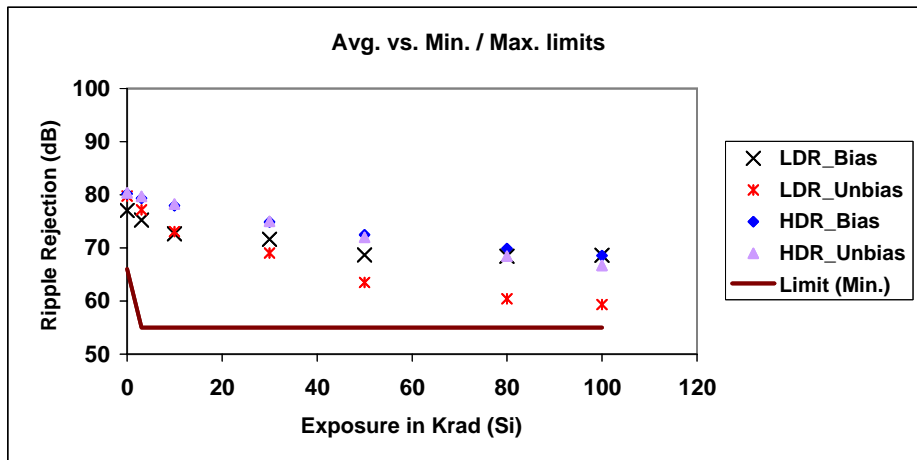

LM117HVHRLQMLV Radiation Data

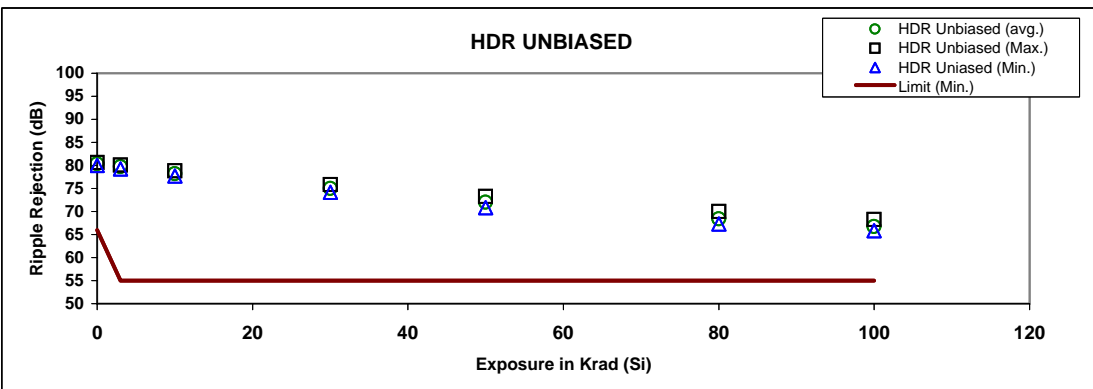
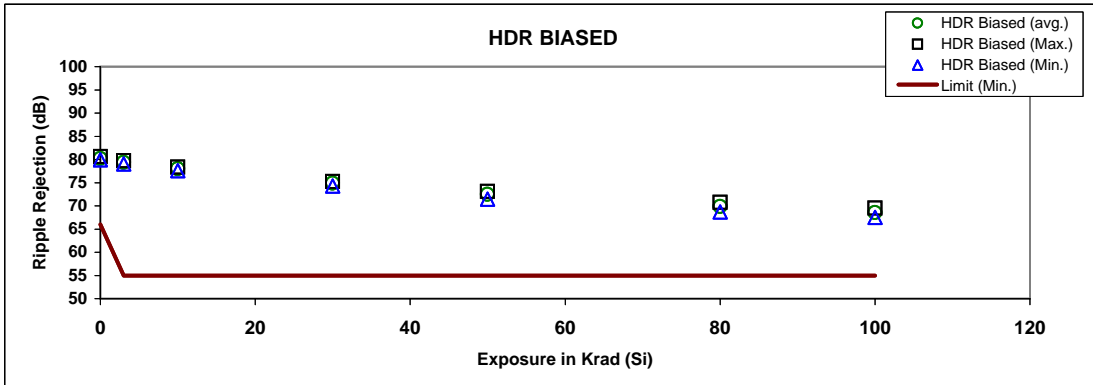
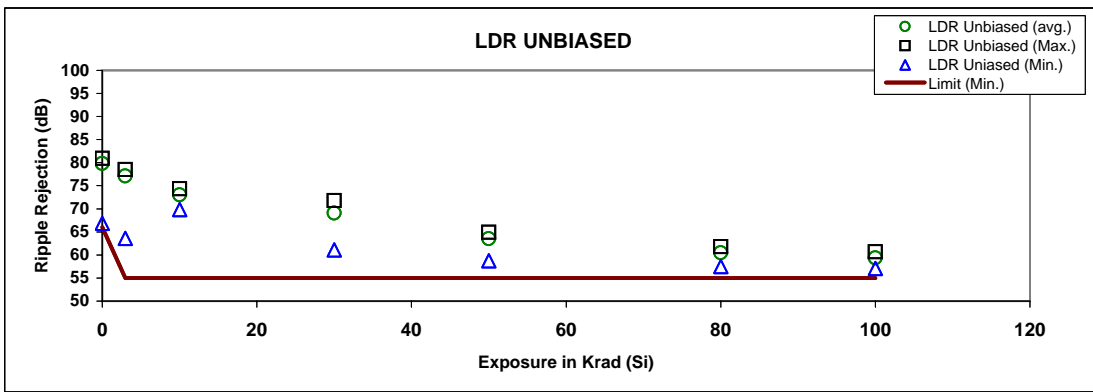
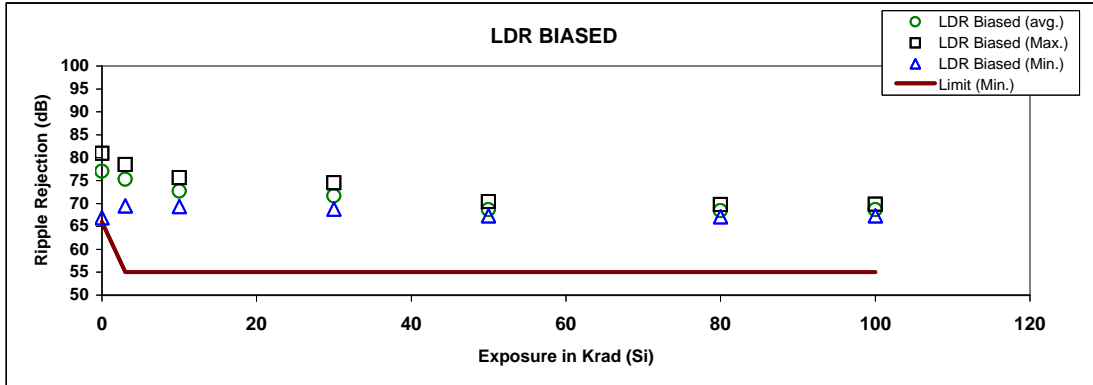

IMPORTANT NOTICE AND DISCLAIMER

TI PROVIDES TECHNICAL AND RELIABILITY DATA (INCLUDING DATA SHEETS), DESIGN RESOURCES (INCLUDING REFERENCE DESIGNS), APPLICATION OR OTHER DESIGN ADVICE, WEB TOOLS, SAFETY INFORMATION, AND OTHER RESOURCES "AS IS" AND WITH ALL FAULTS, AND DISCLAIMS ALL WARRANTIES, EXPRESS AND IMPLIED, INCLUDING WITHOUT LIMITATION ANY IMPLIED WARRANTIES OF MERCHANTABILITY, FITNESS FOR A PARTICULAR PURPOSE OR NON-INFRINGEMENT OF THIRD PARTY INTELLECTUAL PROPERTY RIGHTS.

These resources are intended for skilled developers designing with TI products. You are solely responsible for (1) selecting the appropriate TI products for your application, (2) designing, validating and testing your application, and (3) ensuring your application meets applicable standards, and any other safety, security, regulatory or other requirements.

These resources are subject to change without notice. TI grants you permission to use these resources only for development of an application that uses the TI products described in the resource. Other reproduction and display of these resources is prohibited. No license is granted to any other TI intellectual property right or to any third party intellectual property right. TI disclaims responsibility for, and you will fully indemnify TI and its representatives against, any claims, damages, costs, losses, and liabilities arising out of your use of these resources.

TI's products are provided subject to [TI's Terms of Sale](#) or other applicable terms available either on ti.com or provided in conjunction with such TI products. TI's provision of these resources does not expand or otherwise alter TI's applicable warranties or warranty disclaimers for TI products.

TI objects to and rejects any additional or different terms you may have proposed.

Mailing Address: Texas Instruments, Post Office Box 655303, Dallas, Texas 75265
Copyright © 2022, Texas Instruments Incorporated