

3.6-V to 6.0-V Input, High-Efficiency DC/DC Converter Reference Design for MSP430

PMP - DC/DC Low-Power Converters

ABSTRACT

This reference design is presented to help application designers and others who are trying to use the [MSP430](#) in a system with an input voltage in the range of 3.6 V to 6.0 V and who are also interested in using a high-efficiency dc/dc converter with integrated FETs for a small, simple design.

Contents

1	Features	2
2	Introduction	2
3	Requirements	3
4	List of Materials	5
5	Test Results	6
5.1	Test Results	6

List of Figures

1	3.3-V Startup Waveform	6
2	3.3-V Startup Waveform	6
3	5-V Startup Waveform	6
4	5-V Startup Waveform	6
5	Output Ripple Voltage	6
6	Load Transient 50% to 100% Load	6
7	Switching Node Waveform	7
8	Efficiency vs Output Current	7

List of Tables

1	CC43 Family Power Requirements	3
2	MSP430x1xx Family Power Requirements	3
3	MSP430x2xx Family Power Requirements	3
4	MSP430x4xx Family Power Requirements	4
5	MSP430x5xx Family Power Requirements	5
6	PMP4774 List of Materials	5

1 Features

- 3.6-V to 6.0-V input voltage range
- Fixed 3.3-V output eliminates need for external voltage-setting resistors
- Up to 98% efficiency
- 1-MHz PWM operation for small passive components
- Transitions to PFM mode for highest light-load efficiency
- Capable of driving up to 300 mA (TPS62203)
- Low quiescent current (15 μ A)
- SOT23-5 package

2 Introduction

This reference design is for the MSP430 family of microcontroller devices and accounts for the voltage and current requirements as described herein. The MSP430 family of devices require only a single 3.3-V input; no sequencing is required. The operating input voltage for this reference design is between 3.6 V and 6.0 V. This design is optimized for high-efficiency, small designs with a low part count and quick turnaround time.

All other trademarks are the property of their respective owners.

3 Requirements

The power requirements for each MSP430 family are listed below. The power given is based on the amount of current the core consumes per megahertz (MHz). The *Analog I_{MAX}* column indicates the amount of current added if the additional functional blocks are used.

For more information and other reference designs, please visit www.ti.com/processorpower.

Table 1. CC43 Family Power Requirements

DEVICE FAMILY	PIN NAME	VOLTAGE (V)		CPU I _{MAX} (μA/MHz)	ANALOG I _{MAX} (μA)	SEQUENCING ORDER	TIMING DELAY	COMMENTS
		MIN	MAX					
F613x, F513x	A _{VCC} , D _{VCC} ⁽¹⁾	1.8	3.6	250 ⁽²⁾	I _{REF} = 140	n/a	n/a	+Maximum CPU speed of 20 MHz

- (1) It is recommended to power A_{VCC} and D_{VCC} from the same source. A maximum difference of 0.3 V between A_{VCC} and D_{VCC} can be tolerated during power-up.
- (2) Maximum value for CPU clocked at 20 MHz at 3 V shown. Actual value depends on supply voltage and MCLK/internal regulator settings. Does not include peripheral module supply current or GPIO source/sink currents, which must be added separately.

Table 2. MSP430x1xx Family Power Requirements⁽¹⁾

DEVICE FAMILY	PIN NAME	VOLTAGE (V)		CPU I _{MAX} (μA/MHz) ⁽²⁾	ANALOG I _{MAX} (μA)	COMMENTS
		MIN	MAX			
x11x1A	V _{CC}	1.8	3.6	350	Comp_A = 60	C11x1: 300 μA/MHz max
F12x	V _{CC}	1.8	3.6	350	Comp_A+ = 60	
F11x2, 12x2	V _{CC}	1.8	3.6	350	ADC10 = 1200, I _{REF} = 400	
F13x, 14x[1]	A _{VCC} , D _{VCC} ⁽³⁾	1.8	3.6	560	Comp_A = 60, ADC12 = 1600, I _{REF} = 800	F13x, 14x: Comp_A, ADC12 F14x1: Comp_A
F15x, 16x, 161x	A _{VCC} , D _{VCC} ⁽³⁾	1.8	3.6	600	Comp_A = 60, ADC12 = 1600, I _{REF} = 800, DAC12 = 1500	DAC outputs not loaded; DAC12 currents for a single DAC, max of two DAC12s in device)

- (1) Additional 7-mA maximum required when writing/erasing Flash In-system.
- (2) 8-MHz maximum CPU clock speed (ex. I_{max_x11x1} = 8 MHz × 350 μA = 2.8 mA). V_{CC} = D_{VCC} = A_{VCC} = 3 V. Actual value depends on supply voltage. Does not include peripheral module supply current or GPIO source/sink currents, which must be added separately.
- (3) It is recommended to power A_{VCC} and D_{VCC} from the same source. A maximum difference of 0.3 V between A_{VCC} and D_{VCC} can be tolerated.

Table 3. MSP430x2xx Family Power Requirements⁽¹⁾

DEVICE FAMILY	PIN NAME	VOLTAGE (V)		CPU I _{MAX} (μA/MHz) ⁽²⁾	ANALOG I _{MAX} (μA)	COMMENTS
		MIN	MAX			
F20xx	V _{CC}	1.8	3.6	370	Comp_A+ = 60 ADC10 = 1200, ADC10_I _{REF} = 400 SD16_A + I _{REF} = 1700 RefBuffer = 600	20x1: Comp_A+ 20x2: ADC10 20x3: SD16_A
F21x1	V _{CC}	1.8	3.6	410	Comp_A+ = 60	
F21x2	A _{VCC} , D _{VCC}	1.8	3.6	350	Comp_A+ = 60 ADC10 = 1200, I _{REF} = 400	
F22xx	A _{VCC} , D _{VCC} ⁽³⁾	1.8	3.6	550	ADC12 = 1200, I _{REF} = 400 OA = 290	22x2: ADC10 22x4: ADC10, 2 OAs OA currents for a single amplifier
F23x0	A _{VCC} , D _{VCC} ⁽³⁾	1.8	3.6	550	Comp_A + = 60	

- (1) Additional 7-mA maximum required when writing/erasing Flash In-system.
- (2) 16 MHz maximum CPU clock speed (ex. I_{max_20xx} = 16 MHz × 370 μA = 5.90 mA). V_{CC} = D_{VCC} = A_{VCC} = 3 V. Actual value depends on supply voltage. Does not include peripheral module supply current or GPIO source/sink currents, which must be added separately.
- (3) It is recommended to power A_{VCC} and D_{VCC} from the same source. A maximum difference of 0.3 V between A_{VCC} and D_{VCC} can be tolerated during power-up.

Table 3. MSP430x2xx Family Power Requirements⁽¹⁾ (continued)

DEVICE FAMILY	PIN NAME	VOLTAGE (V)		CPU I _{MAX} ⁽²⁾ (μ A/MHz)	ANALOG I _{MAX} (μ A)	COMMENTS
		MIN	MAX			
F23x, 24x[1], 2410	A _{VCC} , D _{VCC} ⁽³⁾	1.8	3.6	445	Comp_A + = 60, ADC12 = 1000, I _{REF} = 700	224x1: Comp_A+ 23x, 24x, 2410: Comp_A+, ADC12
F241x, 261x	A _{VCC} , D _{VCC} ⁽³⁾	1.8	3.6	560	Comp_A + = 60, ADC12 = 1000, I _{REF} = 700 DAC12 = 1500	241x: Comp_A+, ADC12 261x: Comp_A+, ADC12, two DAC12s DAC12 outputs not loaded; DAC12 currents for a single DAC

Table 4. MSP430x4xx Family Power Requirements⁽¹⁾

DEVICE FAMILY	PIN NAME ⁽²⁾	VOLTAGE (V)		CPU I _{MAX} ⁽³⁾ (μ A/MHz)	ANALOG I _{MAX} (μ A)	COMMENTS
		MIN	MAX			
x41x	A _{VCC} , D _{VCC}	1.8	3.6	350	Comp_A = 60	C41x: 300 μ A/MHz max
FW42x	A _{VCC} , D _{VCC}	1.8	3.6	350	Comp_A = 60 Scan IF = 650	
F42x	A _{VCC} , D _{VCC}	1.8	3.6	500	SD16 + I _{REF} = 1550 Ref Buffer = 600	SD16 current is for a single A/D (three on device)
FE42x[a], 42x2	A _{VCC} , D _{VCC}	1.8	3.6	500	ESP430CE1 = 4900 Ref Buffer = 600	ESP430 current for 4-MHz operation
F43x[1], F44x	A _{VCC} , D _{VCC}	1.8	3.6	560	Comp_A = 60, ADC12 = 1600, I _{REF} = 800	
F42x0	A _{VCC} , D _{VCC}	1.8	3.6	520	SD16_A + I _{REF} =1800 Ref Buffer = 600 DAC12=1500	DAC12 output not loaded
FG42x0	A _{VCC} , D _{VCC}	1.8	3.6	560	SD16_A + I _{REF} =1800 Ref Buffer = 600 DAC12 = 1500, OA = 290	DAC12 output not loaded; OA current for a single amplifier (two OAs in device)
FG43x	A _{VCC} , D _{VCC}	1.8	3.6	570	Comp_A = 60, ADC12 = 1600, I _{REF} = 800, DAC12 = 1500, OA = 490	DAC12 outputs not loaded; OA and DAC12 currents for a single amplifier/DAC (three OAs, two DACs in device)
FG46xx	A _{VCC} , D _{VCC}	1.8	3.6	740	Comp_A = 60, ADC12 = 1600, V _{REF} = 800, DAC12 = 1500, OA = 490	DAC12 outputs no loaded; OA and DAC12 currents for a single amplifier/DAC (three OAs, two DACs in device)
F47xx	A _{VCC} , D _{VCC}	1.8	3.6	560	Comp_A = 60, SD16_A + I _{REF} = 1700 Ref Buffer = 600	16 MHz max CUP frequency; SD16 current is for a single A/D (four on device)

⁽¹⁾ Additional 7-mA maximum required when writing/erasing Flash In-system.

⁽²⁾ It is recommended to power A_{VCC} and D_{VCC} from the same source. A maximum difference of 0.3 V between A_{VCC} and D_{VCC} can be tolerated.

⁽³⁾ 8 MHz maximum CPU clock speed (ex. I_{max_x41x} = 8 MHz \times 350 μ A = 2.8 mA). (F47xx max CPU clock = 16 MHz) V_{CC} = D_{VCC} = A_{VCC} = 3 V. Actual value depends on supply voltage. Does not include peripheral module supply current or GPIO source/sink currents, which must be added separately. LCD current not included.

Table 5. MSP430x5xx Family Power Requirements⁽¹⁾

DEVICE FAMILY	PIN NAME	VOLTAGE (V)		CPU I _{MAX} (μA/MHz) ⁽²⁾	ANALOG I _{MAX} (μA)	COMMENTS
		MIN	MAX			
F54xx	A _{VCC} , D _{VCC} ⁽³⁾	2.2	3.6	348	ADC12_A = 220, I _{REF} = 190	18 MHz maximum CPU clock speed

⁽¹⁾ Additional 5-mA maximum required when writing/erasing Flash In-system.

⁽²⁾ 16 MHz maximum at 3-V CPU clock speed. Actual value depends on supply voltage and MCLK/internal regulator settings. Does not include peripheral module supply current or GPIO source/sink currents, which must be added separately.

⁽³⁾ It is recommended to power A_{VCC} and D_{VCC} from the same source. A maximum difference of 0.3 V between A_{VCC} and D_{VCC} can be tolerated during power-up.

4 List of Materials

Table 6 shows the bill of materials (BOM) for this design.

Table 6. PMP4774 List of Materials

REF DES	QTY	VALUE	DESCRIPTION	SIZE	PART NUMBER	MFR
C1	1	4.7 μF	Capacitor, Ceramic, 6.3 V, X5R, 20%	0805	GRM21BR60J475KA11	muRata
C4	1	10 μF	Capacitor, Ceramic, 6.3 V, X5R, 20%	0805	C2012X5R0J106M	TDK
L1	1	10 μH	Inductor, SMT, 10 μH, 1 A, 128 mΩ	0.185x0.185	CDRH4D28-100	Sumida
U1	1	TPS62203	IC, Switching Buck Converter, 1.8 V, 300 mA	SOT23-5	TPS62203DBV	Texas Instruments
R1	1	0	Resistor, Chip, 0 Ω, 1/16-W, yy%	0603	Std	Std

5 Test Results

The input and output startup waveforms are shown in Figure 1 through Figure 4. The 3.3-V output ripple voltage is shown in Figure 5. Figure 6 shows the 3.3-V transient response. The switching node waveform is shown in Figure 7.

5.1 Test Results

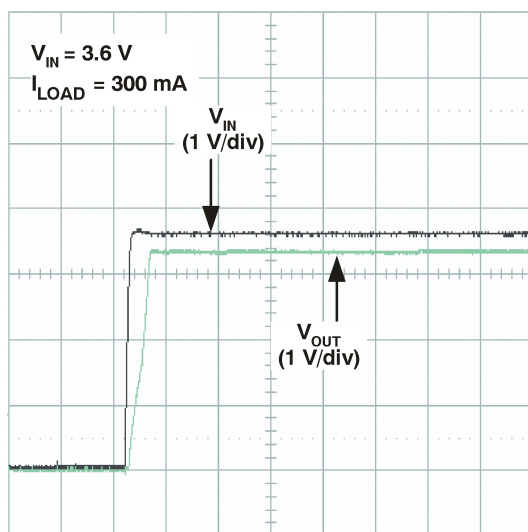

t – Time – 1 ms/div

Figure 1. 3.3-V Startup Waveform

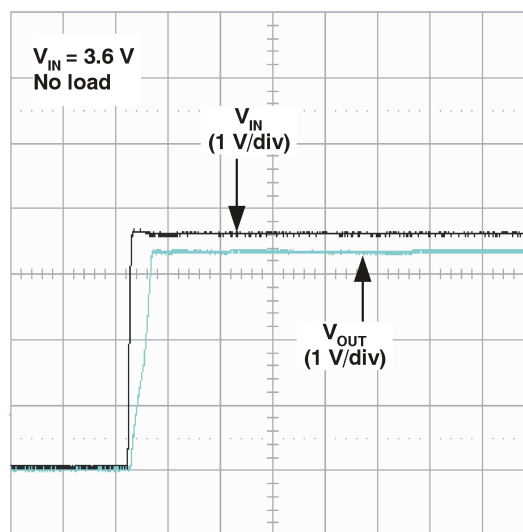

t – Time – 1 ms/div

Figure 2. 3.3-V Startup Waveform

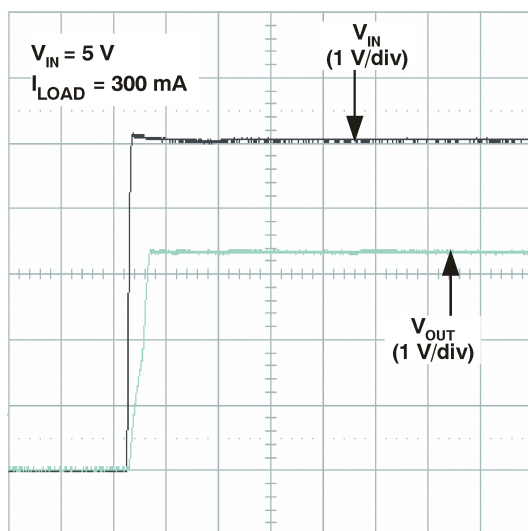

t – Time – 1 ms/div

Figure 3. 5-V Startup Waveform

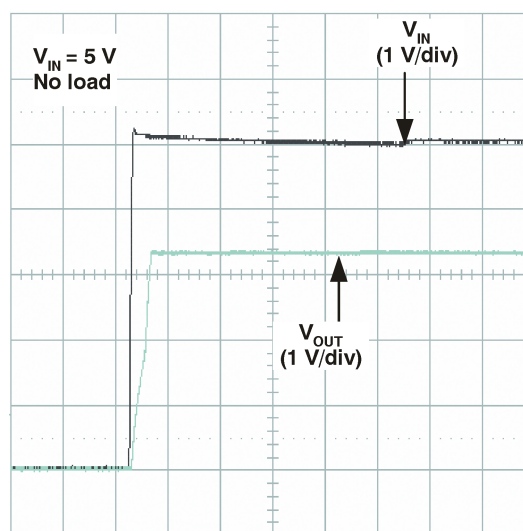

t – Time – 1 ms/div

Figure 4. 5-V Startup Waveform

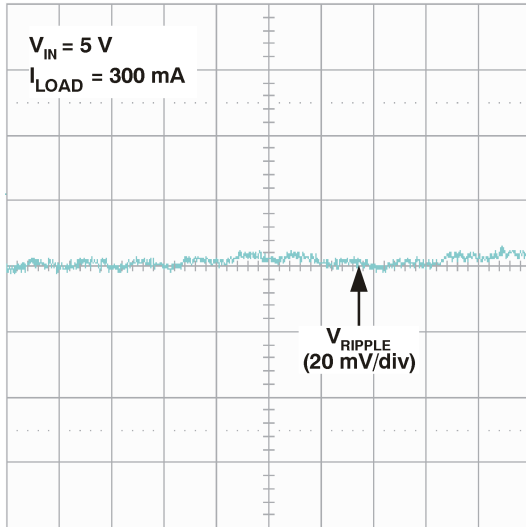

Figure 5. Output Ripple Voltage

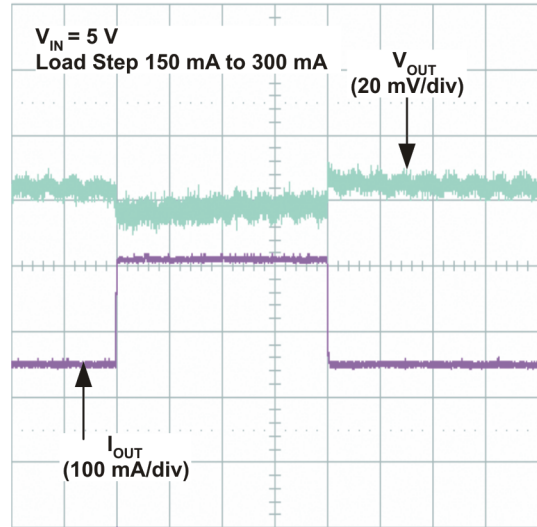

Figure 6. Load Transient 50% to 100% Load

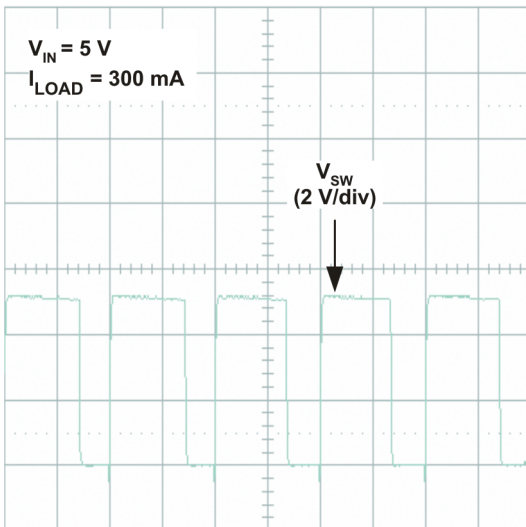

Figure 7. Switching Node Waveform

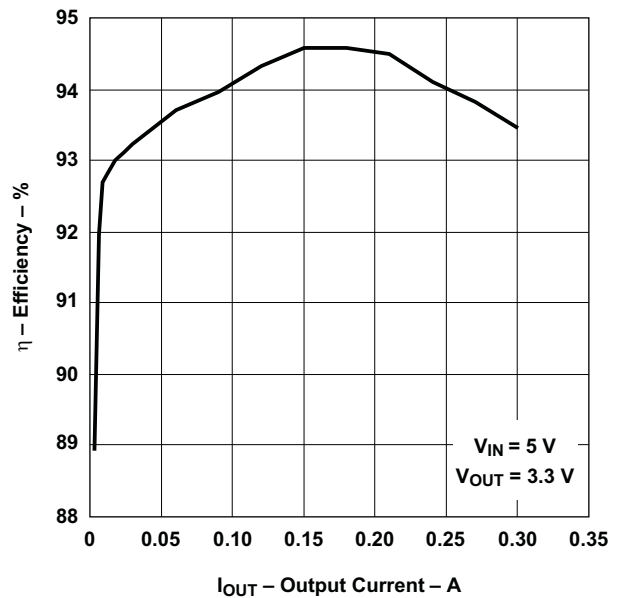

Figure 8. Efficiency vs Output Current

IMPORTANT NOTICE

Texas Instruments Incorporated and its subsidiaries (TI) reserve the right to make corrections, modifications, enhancements, improvements, and other changes to its products and services at any time and to discontinue any product or service without notice. Customers should obtain the latest relevant information before placing orders and should verify that such information is current and complete. All products are sold subject to TI's terms and conditions of sale supplied at the time of order acknowledgment.

TI warrants performance of its hardware products to the specifications applicable at the time of sale in accordance with TI's standard warranty. Testing and other quality control techniques are used to the extent TI deems necessary to support this warranty. Except where mandated by government requirements, testing of all parameters of each product is not necessarily performed.

TI assumes no liability for applications assistance or customer product design. Customers are responsible for their products and applications using TI components. To minimize the risks associated with customer products and applications, customers should provide adequate design and operating safeguards.

TI does not warrant or represent that any license, either express or implied, is granted under any TI patent right, copyright, mask work right, or other TI intellectual property right relating to any combination, machine, or process in which TI products or services are used. Information published by TI regarding third-party products or services does not constitute a license from TI to use such products or services or a warranty or endorsement thereof. Use of such information may require a license from a third party under the patents or other intellectual property of the third party, or a license from TI under the patents or other intellectual property of TI.

Reproduction of TI information in TI data books or data sheets is permissible only if reproduction is without alteration and is accompanied by all associated warranties, conditions, limitations, and notices. Reproduction of this information with alteration is an unfair and deceptive business practice. TI is not responsible or liable for such altered documentation. Information of third parties may be subject to additional restrictions.

Resale of TI products or services with statements different from or beyond the parameters stated by TI for that product or service voids all express and any implied warranties for the associated TI product or service and is an unfair and deceptive business practice. TI is not responsible or liable for any such statements.

TI products are not authorized for use in safety-critical applications (such as life support) where a failure of the TI product would reasonably be expected to cause severe personal injury or death, unless officers of the parties have executed an agreement specifically governing such use. Buyers represent that they have all necessary expertise in the safety and regulatory ramifications of their applications, and acknowledge and agree that they are solely responsible for all legal, regulatory and safety-related requirements concerning their products and any use of TI products in such safety-critical applications, notwithstanding any applications-related information or support that may be provided by TI. Further, Buyers must fully indemnify TI and its representatives against any damages arising out of the use of TI products in such safety-critical applications.

TI products are neither designed nor intended for use in military/aerospace applications or environments unless the TI products are specifically designated by TI as military-grade or "enhanced plastic." Only products designated by TI as military-grade meet military specifications. Buyers acknowledge and agree that any such use of TI products which TI has not designated as military-grade is solely at the Buyer's risk, and that they are solely responsible for compliance with all legal and regulatory requirements in connection with such use.

TI products are neither designed nor intended for use in automotive applications or environments unless the specific TI products are designated by TI as compliant with ISO/TS 16949 requirements. Buyers acknowledge and agree that, if they use any non-designated products in automotive applications, TI will not be responsible for any failure to meet such requirements.

Following are URLs where you can obtain information on other Texas Instruments products and application solutions:

Products		Applications	
Amplifiers	amplifier.ti.com	Audio	www.ti.com/audio
Data Converters	dataconverter.ti.com	Automotive	www.ti.com/automotive
DLP® Products	www.dlp.com	Communications and Telecom	www.ti.com/communications
DSP	dsp.ti.com	Computers and Peripherals	www.ti.com/computers
Clocks and Timers	www.ti.com/clocks	Consumer Electronics	www.ti.com/consumer-apps
Interface	interface.ti.com	Energy	www.ti.com/energy
Logic	logic.ti.com	Industrial	www.ti.com/industrial
Power Mgmt	power.ti.com	Medical	www.ti.com/medical
Microcontrollers	microcontroller.ti.com	Security	www.ti.com/security
RFID	www.ti-rfid.com	Space, Avionics & Defense	www.ti.com/space-avionics-defense
RF/IF and ZigBee® Solutions	www.ti.com/lprf	Video and Imaging	www.ti.com/video
		Wireless	www.ti.com/wireless-apps

Mailing Address: Texas Instruments, Post Office Box 655303, Dallas, Texas 75265
Copyright © 2010, Texas Instruments Incorporated