

UCC33420EVM-080 Evaluation Module for Automotive and Industrial Applications



Description

The UCC33420EVM-080 is intended to allow designers to evaluate the performance and capabilities of UCC33xx0 family of automotive and industrial devices. UCC33420 is an isolated DC/DC converter module able to deliver 1.5W with 3kVrms of isolation in a very small and compact 4mmx5mmx1mm VSON-12 package, reducing footprint and providing a high-power density. UCC334x0 devices can operate from 4.5V to 5.5V and UCC330x0 from 3.0V to 5.5V at the input side. UCC33x20 devices can regulate the secondary side to 5V or 5.5V and UCC33x10 to 3.3V or 3.7V configuring the SEL pin. This EVM demonstrates typical isolated bias supply voltages used in automotive and industrial applications.

Features

- UCC33420-Q1 1.5W DC/DC isolated converter module with isolated bias supply power.
- Transformer, power and control stage fully integrated in a 4mmx5mmx1mm VSON-12 package with 12 pins
- AEC-Q100, 3kVrms isolation, protection features and low electromagnetic emissions
- EVM demonstrates an isolated bias supply used in automotive and industrial applications

Applications

- Factory automation PLC modules
- [EV charging infrastructure](#)
- [Battery Management Systems \(BMS\)](#)
- [HEV/EV OBC and DC/DC converter](#)
- Isolated power for voltage and current sensors
- Isolated bias power for digital isolators
- Isolated bias power for RS-485, RS-422 and CAN

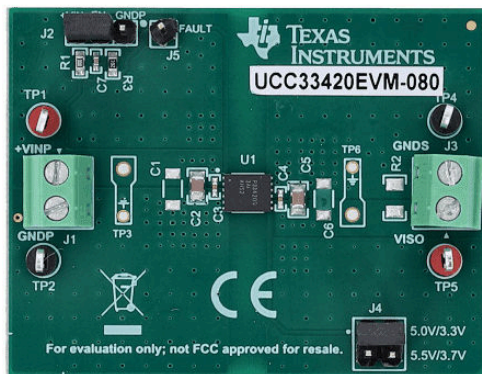

UCC33420EVM-080 (top view)

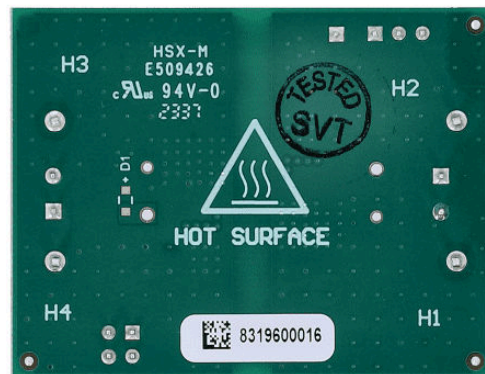

UCC33420EVM-080 (bottom view)

1 Evaluation Module Overview

1.1 Introduction

This user's guide provides directions for use of the UCC33420EVM-080 to evaluate the UCC33420-Q1 high frequency integrated transformer DC-DC converter, low emissions, 3kV_{RMS} module from Texas Instruments. UCC33420-Q1 comes in a minimum footprint VSON-12 package which provides high-power density, 1.5W nominal power. The UCC33420-Q1 delivers class-leading efficiency in power conversion from the primary to the secondary side while removing the need for external transformers or power modules commonly required in existing designs. This integration allows for minimal printed circuit board (PCB) area as well as decreased height profile.

1.2 Kit Contents

Table 1-1. UCC33420EVM-080 Kit Contents

Designator	Description	Quantity
PCB1	UCC33420EVM-080 Circuit Board	1

1.3 Device Information

1.3.1 U1 Component Selection

The UCC33420-Q1 is the default IC used in the UCC33420EVM-080 but any of the alternate versions listed in [Table 1-2](#) can be used for evaluation. Each of the component versions listed in [Table 1-2](#) are pin-to-pin compatible.

Table 1-2. UCC33xx0-Q1 Devices

General Part Number	Orderable Part Number	Input Voltage/Output Voltage/Isolation
UCC33420-Q1	PUCC33420QRAQRQ1	4.5V-5.5V/5.0V/3kV _{RMS}
UCC33420	PUCC33420RAQR	4.5V-5.5V/5.0V/3kV _{RMS}
UCC33410-Q1	PUCC33410QRAQRQ1	4.5V-5.5V/3.3V/3kV _{RMS}
UCC33410	PUCC33410RAQR	4.5V-5.5V/3.3V/3kV _{RMS}
UCC33020-Q1	PUCC33420QRAQRQ1	3V-5.5V/5.0V/3kV _{RMS}
UCC33020	PUCC33420RAQR	3V-5.5V/5.0V/3kV _{RMS}

If IC replacement is required, TI recommends to always use best practice soldering techniques which can include taking appropriate ESD precautions and having qualified personnel, skilled at surface mount soldering and board level rework.

1.3.2 UCC33420-Q1 Pin Definition

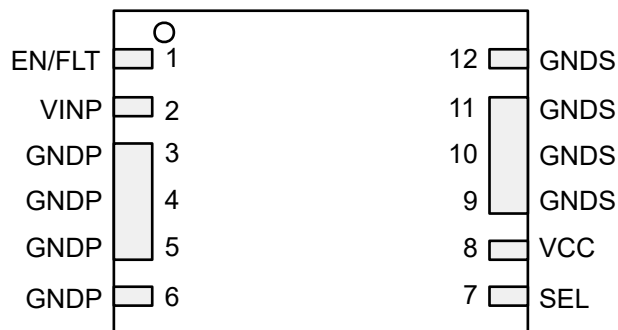

Figure 1-1. UCC33420-Q1 Package (top view)

Table 1-3. UCC33420-Q1 Pin Description

Pin		Type ⁽¹⁾	Description
Name	No.		
EN/FLT	1	I/O	Multi-functional enable input pin and output fault pin. Connect to microcontroller through an 18kΩ or greater pull-up resistor. Enable input pin: Forcing EN low disables the device. Pull high to enable normal device functionality. Fault output pin: This pin is pulled low for 200us to alert that power converter is shutdown due to a fault condition.
VINP	2	P	Primary input supply voltage. Connect parallel 15nF 0402, and 10μF ceramic bypass capacitors close to VINP to GNDP pins.
GNDP	3, 4, 5, 6	G	Power ground return connection for VINP.
SEL	7	I	VCC selection pin. VCC setpoint is 5V when SEL is connected to VCC and 5.5V when SEL is shorted to GNDS.
VCC	8	P	Isolated supply output voltage pin. Connect parallel 15nF 0402, and 22μF ceramic bypass capacitors close to VCC and GNDS pins.
GNDS	9, 10, 11, 12	G	Power ground return connection for VCC.

(1) P=Power, G=Ground, I=Input, O=Output

1.4 Specification

Table 1-4. UCC33420-Q1 EVM Electrical Characteristics

VINP=5V, VCC=5V, T_A=25°C (unless otherwise noted)

Parameter		Test Conditions	Min	Typ	Max	Unit
Input Characteristics						
VINP	Input voltage range	P _{VCC} =1.5W	4.5	5	5.5	V
I _{IN_FL}	Input current at full load	VINP=4.5V-5.5V, VCC=5.0V, I _{out} =300 mA		535		mA
I _{IN_NL}	Input current at no load	VINP =5.0V, VCC=5.0V, I _{out} =0 mA		7	15	mA
Output Characteristics						
VCC	DC full load set-point	VINP=4.5V-5.5V, VCC=5.0V, I _{out} =300 mA	4.85	5	5.15	V
I _{out}	VCC load current range	VINP=4.5V-5.5V	0		300	mA
VCC _{%LD}	Load regulation	VINP=5.0V, VCC=5.0V, I _{out} =0-300mA		0.5		%
VCC _(AC)	pk-to-pk AC ripple	20MHz bandwidth, VINP=5.0V, VCC=5.0V, I _{out} =300mA, T _A =25°C, C _{OUT} =22uF		50	75	mV
P _{MAX}	Recommended maximum output power	VINP=5.0V, I _{out} =300mA, T _A =25°C		1.5		W
System Characteristics						
η	Full load efficiency	VINP=5.0V, VCC=5.0V, I _{out} =300mA, T _A =25°C, C _{OUT} =22uF		59		%
f _{SW}	Switching frequency			64.5		MHz

Table 1-5. UCC33410-Q1 EVM Electrical Characteristics

VINP=5V, VCC=3.3V, T_A=25°C (unless otherwise noted)

Parameter		Test Conditions	Min	Typ	Max	Unit
Input Characteristics						
VINP	Input voltage range	P _{VCC} =1W	4.5	5	5.5	V
I _{IN_FL}	Input current at full load	VINP=4.5V-5.5V, VCC=3.3V, I _{out} =300 mA	375	395	412	mA
I _{IN_NL}	Input current at no load	VINP =5.0V, VCC=3.3V, I _{out} =0 mA		7	15	mA

Table 1-5. UCC33410-Q1 EVM Electrical Characteristics (continued)

VINP=5V, VCC=3.3V, TA=25°C (unless otherwise noted)

Parameter		Test Conditions	Min	Typ	Max	Unit
Output Characteristics						
VCC	DC full load set-point	VINP=4.5V-5.5V, VCC=3.3V, I _{out} =300 mA	3.2	3.3	3.4	V
I _{out}	VCC load current range	VINP=4.5V-5.5V	0		300	mA
VCC%LD	Load regulation	VINP=5.0V, VCC=3.3V, I _{out} =0-300mA		0.5		%
VCC _(AC)	pk-to-pk AC ripple	20MHz bandwidth, VINP=5.0V, VCC=3.3V, I _{out} =300mA, TA=25°C, C _{OUT} =22uF		50	75	mV
P _{MAX}	Recommended maximum output power	VINP=5.0V, I _{out} =300mA, TA=25°C		1		W
System Characteristics						
η	Full load efficiency	VINP=5.0V, VCC=3.3V, I _{out} =300mA, TA=25°C, C _{OUT} =22uF		53		%
f _{SW}	Switching frequency			64.5		MHz

Table 1-6. UCC33020-Q1 EVM Electrical Characteristics

VINP=3.3V, VCC=5V, TA=25°C (unless otherwise noted)

Parameter		Test Conditions	Min	Typ	Max	Unit
Input characteristics						
VINP	Input voltage range		3.0		5.5	V
I _{IN_FL}	Input current at full load	VINP=3.3V, VCC=5.0V, I _{out} =100 mA	390	415	450	mA
		VINP=5.0V, VCC=5.0V, I _{out} =200 mA	365	400	435	mA
I _{IN_NL}	Input current at no load	VINP =3.3V, VCC=5.0V, I _{out} =0 mA		7	15	mA
		VINP =5.0V, VCC=5.0V, I _{out} =0 mA		7	15	mA
Output Characteristics						
VCC	DC full load set-point	VINP=3.3V, VCC=5.0V, I _{out} =0-100 mA	4.85	5	5.15	V
		VINP=5.0V, VCC=5.0V, I _{out} =0-200 mA	4.85	5	5.15	V
I _{out}	VCC load current range	VINP=3.3V, VCC=5.0V	0		100	mA
		VINP=5.0V, VCC=5.0V	0		200	mA
VCC%LD	Load regulation	VINP=3.3V, VCC=5.0V, I _{out} =0-100mA		0.2	0.4	%
		VINP=5.0V, VCC=5.0V, I _{out} =0-200mA		0.5	0.7	%
VCC _(AC)	pk-to-pk AC ripple	20MHz bandwidth, VINP=3.3V, VCC=5.0V, I _{out} =100mA, Ta=25°C, C _{OUT} =22uF		50	75	mV
		20MHz bandwidth, VINP=5.0V, VCC=5.0V, I _{out} =200mA, Ta=25°C, C _{OUT} =22uF		50	75	mV
P _{MAX}	Recommended maximum output power	VINP=3.3V, I _{out} =100mA, Ta=25°C		0.5		W
		VINP=5.0V, I _{out} =200mA, Ta=25°C		1		W
System Characteristics						
η	Full load efficiency	VINP=3.3V, VCC=5.0V, I _{out} =100mA, Ta=25°C, C _{OUT} =22uF		50		%
		VINP=5.0V, VCC=5.0V, I _{out} =200mA, Ta=25°C, C _{OUT} =22uF		52		%
f _{SW}	Switching frequency			64.5		MHz

2 Hardware

2.1 EVM Setup and Operation

2.1.1 Recommended Test Equipment

1. V_{EN} : DC power supply: 5.0V, 10mA
2. V_{INP} : DC power supply: 5.0V, 1A
3. I_{out} : Electronic load or fixed resistor: 5V, 500mA
4. (2) DVMs measuring DC voltage <10V
5. (2) DVMs measuring DC current <1.0A on I_{VINP} and I_{out}
6. Oscilloscope: 4 channel, 500MHz or higher, voltage probes, current probes
7. Minimum wire gauge 20 AWG to 22 AWG or heavier
8. Thermal camera or thermocouple to measure U1 case temperature

2.1.2 External Connections for Easy Evaluation

The UCC33420EVM-080 EVM utilizes screw terminals for easily connecting to V_{INP} and VCC. EN connections are made through pin connectors. Connecting the appropriate ammeters and voltmeters, as shown in Figure 4-1, allows accurate EVM efficiency measurements.

Connecting Test Equipment:

1. Connect the V_{INP} DC power supply capable of $4.5V < V_{INP} < 5.5V$, 1A at J1:1-2 (V_{INP} -GNDP). With the power supply disable, adjust the power supply to 5.0V, and set the current limit to 4A.
2. Connect a power supply capable of 5V, 100mA at J2:2-1 to serve as the pull up bias for EN/FLT. With the supply disabled, set to 3.3V/5.0V. As an option, the user can use the input power supply as a bias supply connecting a jumper to short $+V_{INP}$ and EN pins at J2:1-2 (top left corner).
3. Connect a variable load between J3:1 (VCC) and J3:2 (GNDS). If using an electronic load, then set to constant current (CC), 300mA. Leave the load disabled until the EVM is powered.
4. Some electronic loads are not able to regulate or stabilize CC when setting in the low mA range. Monitor the input current and load currents by inserting ammeters as shown in Figure 2-1. A current probe can be used with the oscilloscope to verify the stability of the DC current being regulated by an electronic load.

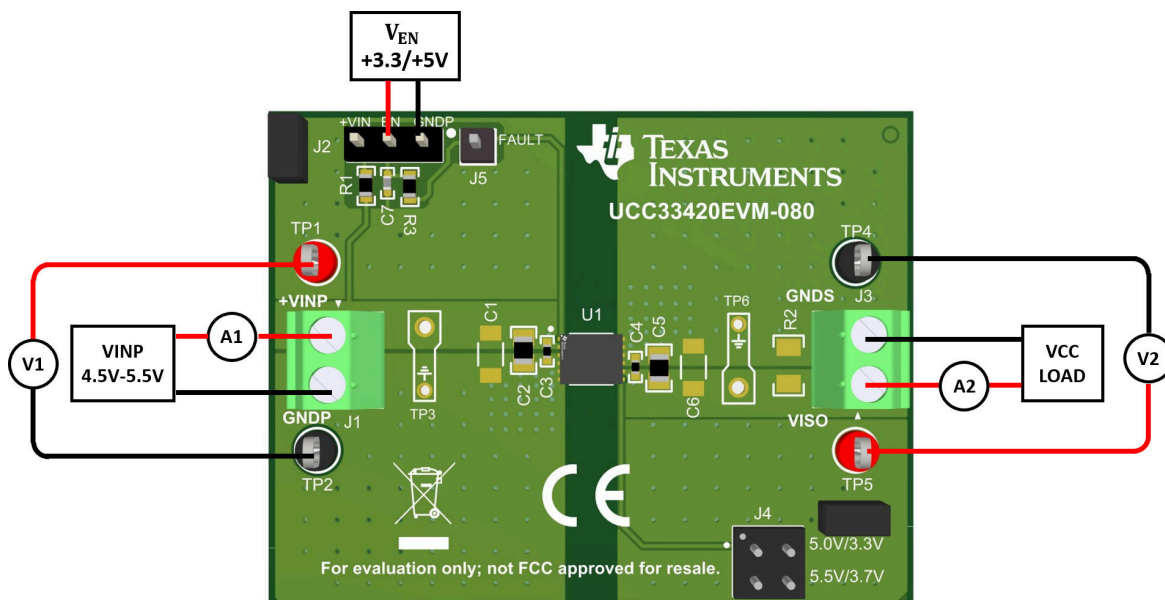



Figure 2-1. Typical Efficiency Measurement Setup

2.1.3 Powering the EVM

WARNING



- Hot surface. Contact can cause burns. U1 package surface can reach temperatures of 100°C above ambient. Do not touch!
- Do not test this EVM unless trained in the proper safety, handling and testing of power electronics.

Power on for Start-up:

1. Verify VINP and V_{EN} power supplies are off/disabled and no voltage is applied to the DUT.
2. Verify the load on VCC is disabled.
3. Turn on the VINP DC power supply. Verify 5V is present at TP1-to-TP2.
4. Turn on the V_{EN} bias power supply. EVM is now enabled with VCC in regulation under no load condition.
5. Verify 5V present on VCC-GNDS.
6. Enable the 300mA load on VCC.
7. The UCC33420 is now regulating VCC and processing 1.5W of isolated output power.
8. Vary VINP between 4.5 V < VINP < 5.5 V, vary I_{out} between 0 mA < I_{out} < 300 mA.
9. Insert oscilloscope probes into TP3 and TP6 for measuring VINP and VCC startup, steady state and AC ripple voltage.

Power off for Shutdown:

1. Turn off V_{EN} power supply.
2. Disable I_{out} load.
3. Turn off VINP power supply.

2.1.4 EVM Test Points

Table 2-1 describes the various EVM test points, allowing easy access for connecting oscilloscope probes, DVM test leads and wire connections to lab test equipment as outlined in Section 2.1.1. Maintain separation between the primary side, GNDP, and secondary side, GNDS. Ensure that primary-side test points are not referenced to GNDS through improper test equipment insertion. Likewise, secondary-side test points are not to be referenced to GNDP through improper test equipment insertion.

Table 2-1. Input, Output, Test Point (I/O/TP) Description

Pin	I/O/TP	Color	Description	Min	Typ	Max	Unit	
J1	I	Green	VINP, primary input voltage.	4.5	5.0	5.5	V	
J2:1-2	I	Black	EN, on		0		V	
J2:2-3	I	Black	EN, off	0	V _{BIAS}	5.5	V	
J4:1-2	O	Black	Selector 5.0V/3.3V output voltage.	0		5.7	V	
J4:3-4	O	Black	Selector 5.5V/3.7V output voltage.	0		5.7	V	
J3	O	Green	VCC, secondary output voltage.	0		5.7	V	
TP1	TP	Red	VINP, primary input voltage test point.	4.5	5	5.5	V	
TP2	TP	Black	GNDP, primary ground test point.		0		V	
TP3	TP	PCB	VINP-to-GNDP, scope probe point.	4.5	5	5.5	V	
TP4	TP	Black	GNDS, secondary ground test point.		0		V	
TP5	TP	Red	VCC, secondary output voltage test point.	4.85	5	5.15	V	
TP6	TP	PCB	VCC-to-GNDS, scope probe point.	SEL 5.0V	4.85	5	5.15	V
				SEL 5.5V	5.34	5.5	5.67	V

2.1.5 Oscilloscope Probes: Probing the EVM

Using TP3 and TP6 Oscilloscope Probe PCB Test Points

The UCC33420-Q1 is a high frequency DC-DC module that requires careful measurement for accurately capturing transient events and measuring high frequency, AC ripple voltage. Remove the *witch hat* probe tip cover and ground lead from the scope probe. If scope probe ground springs are not available, wrap a piece of 22 AWG bare wire around the scope probe ground ring. Insert probe tip and ground into the EVM as shown in [Figure 2-2](#).

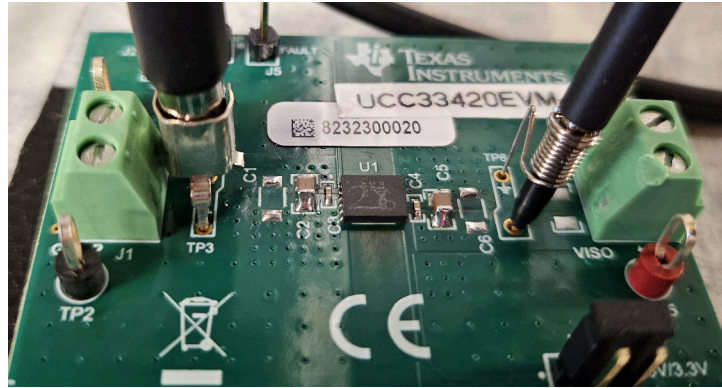

Figure 2-2. PCB Scope Probe Test Points

The EVM input (VINP, GNDP) and output nomenclature (VCC, GNDS) corresponds to what is commonly used when referring to isolated amplifiers that need to be biased from primary and secondary sides.

3 Implementation Results

3.1 Schematic

Figure 3-1 shows the EVM electrical schematic. C1, C6, R2 and D1 are intentionally unpopulated as indicated by a red X placed directly over the component. The user can use C1 and C8 placeholders to add input or output capacitance as required for their systems.

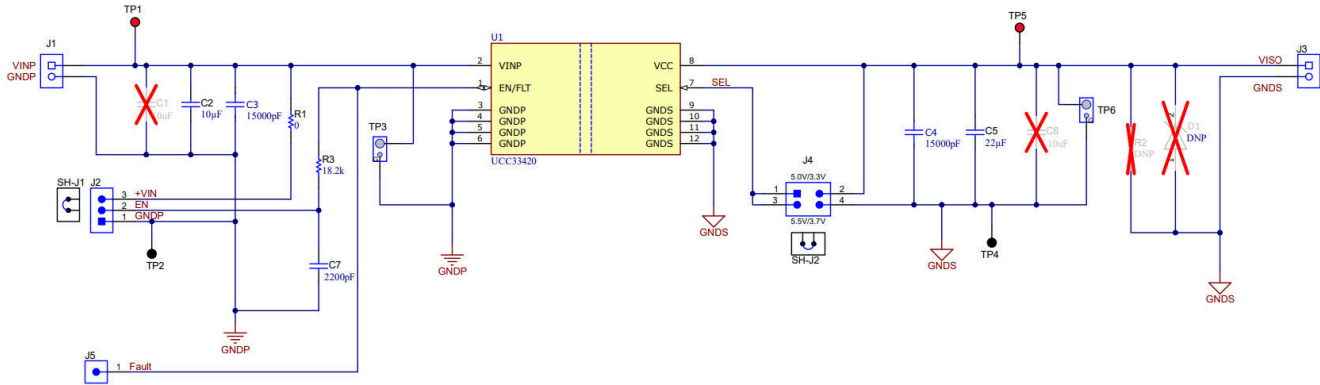

Figure 3-1. Schematic

3.2 Performance Data

UCC33420-Q1 VINP=5.0V, VCC=5.0V, $T_A=25^\circ\text{C}$ (unless otherwise noted).

UCC33410-Q1 VINP=5.0V, VCC=3.3V, $T_A=25^\circ\text{C}$ (unless otherwise noted).

UCC33020-Q1 VINP=3.3V, VCC=5.0V, $T_A=25^\circ\text{C}$ (unless otherwise noted).

3.2.1 Efficiency Data

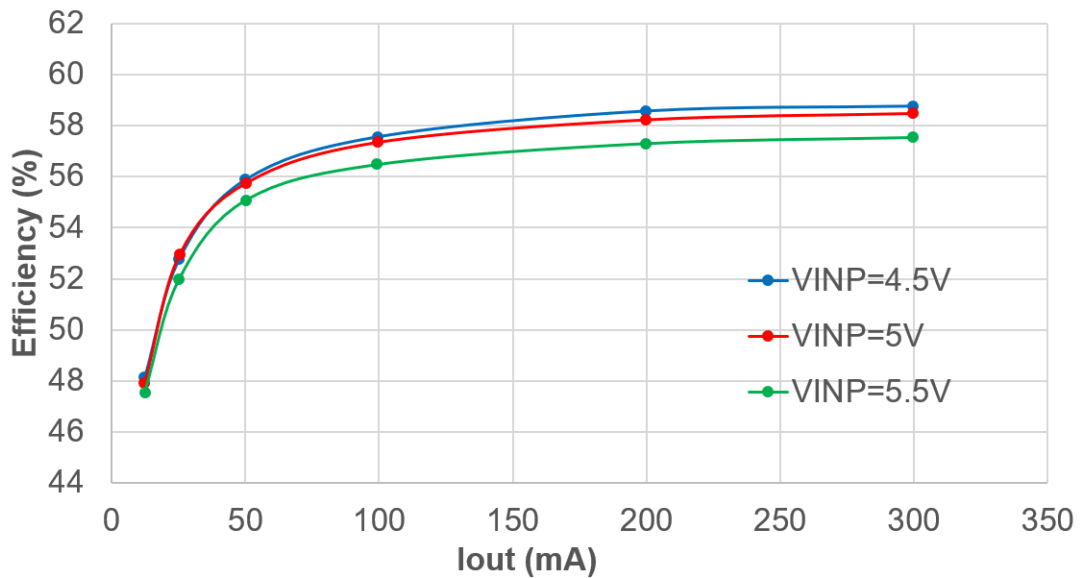

Figure 3-2. UCC33420-Q1 Efficiency VCC=5.0V

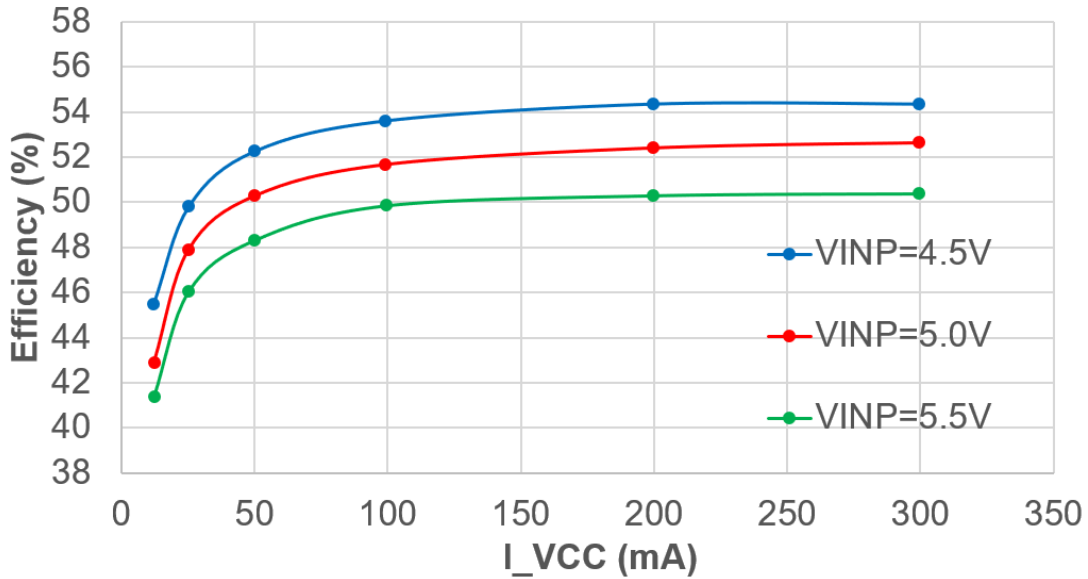

Figure 3-3. UCC33410-Q1 Efficiency VCC=3.3V

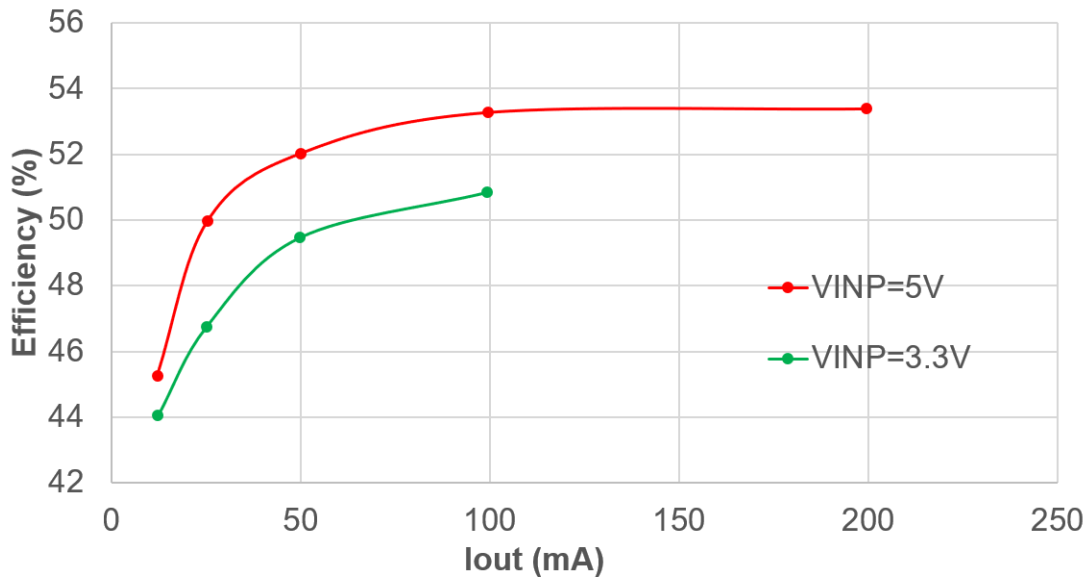

Figure 3-4. UCC33020-Q1 Efficiency VCC=5.0V

3.2.2 Regulation Data

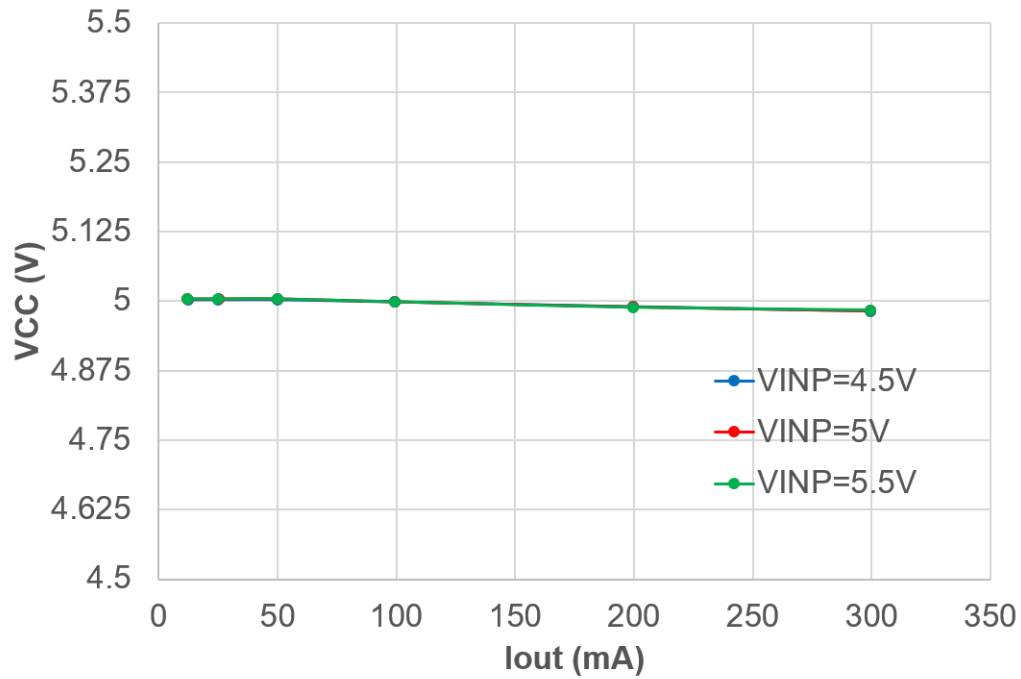

Figure 3-5. UCC33420-Q1 Regulation vs Load Current VCC=5.0V

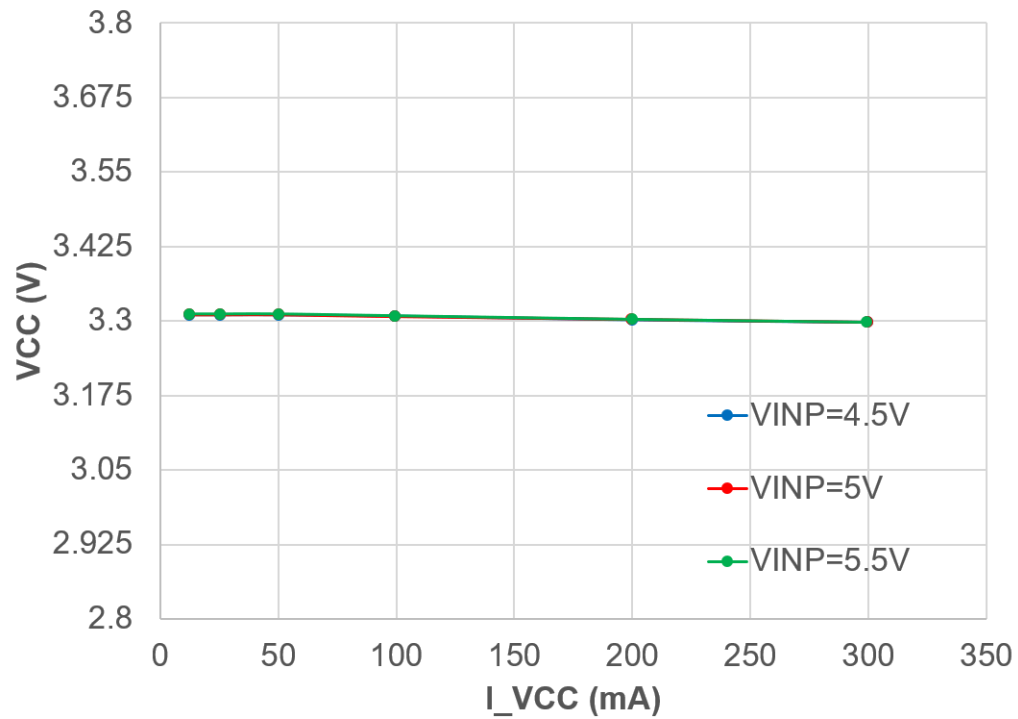

Figure 3-6. UCC33410-Q1 Regulation vs Load Current VCC=3.3V

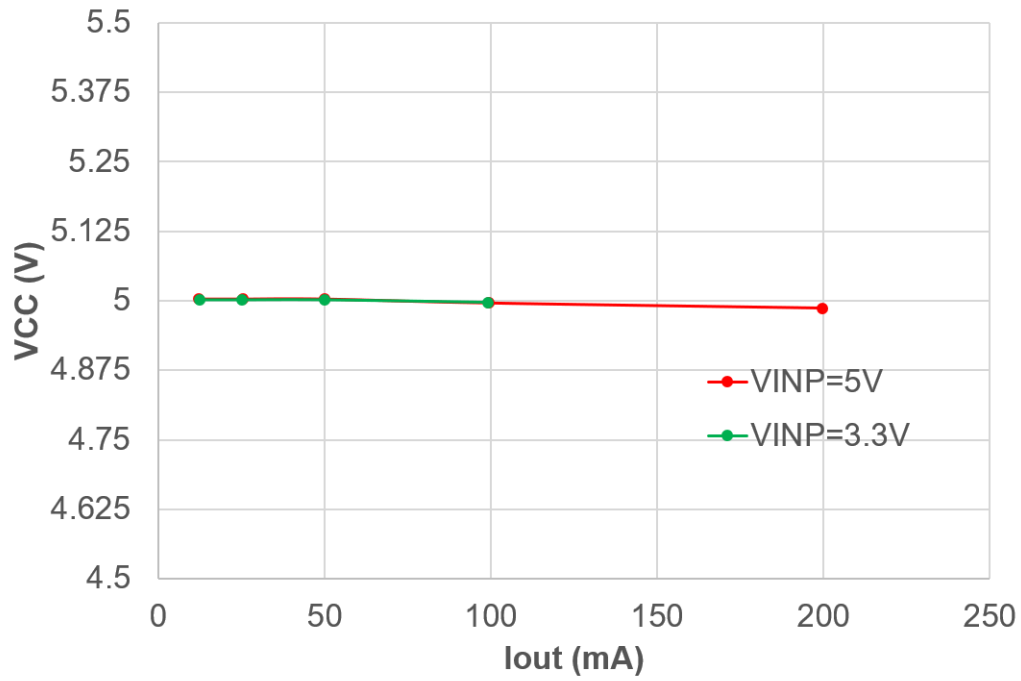

Figure 3-7. UCC33020-Q1 Regulation vs Load Current VCC=5.0V

3.2.3 Startup Waveforms

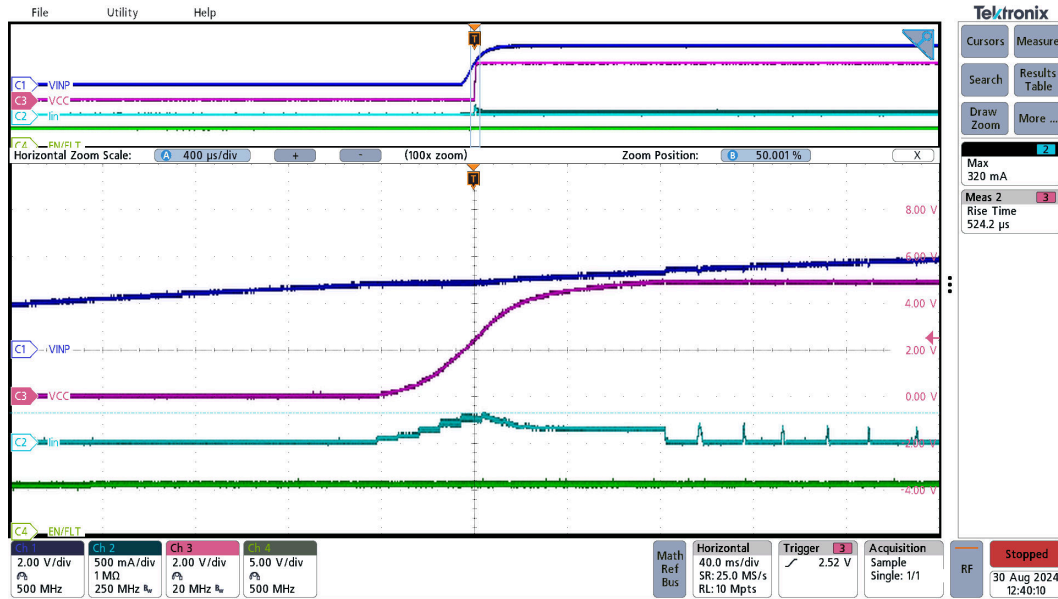

Figure 3-8. UCC33420-Q1 Start-Up, Sequence EN=5.0V → VINP=5.0V, VCC=5.0V, Iout=0mA

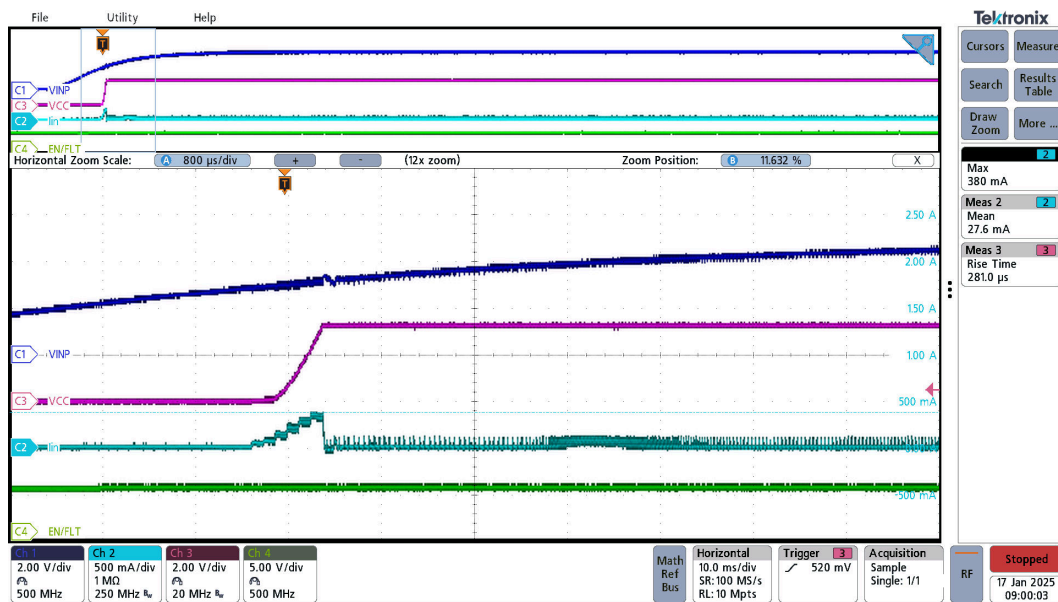

Figure 3-9. UCC33410-Q1 Start-Up, Sequence EN=5.0V → VINP=5.0V, VCC=3.3V, Iout=0mA

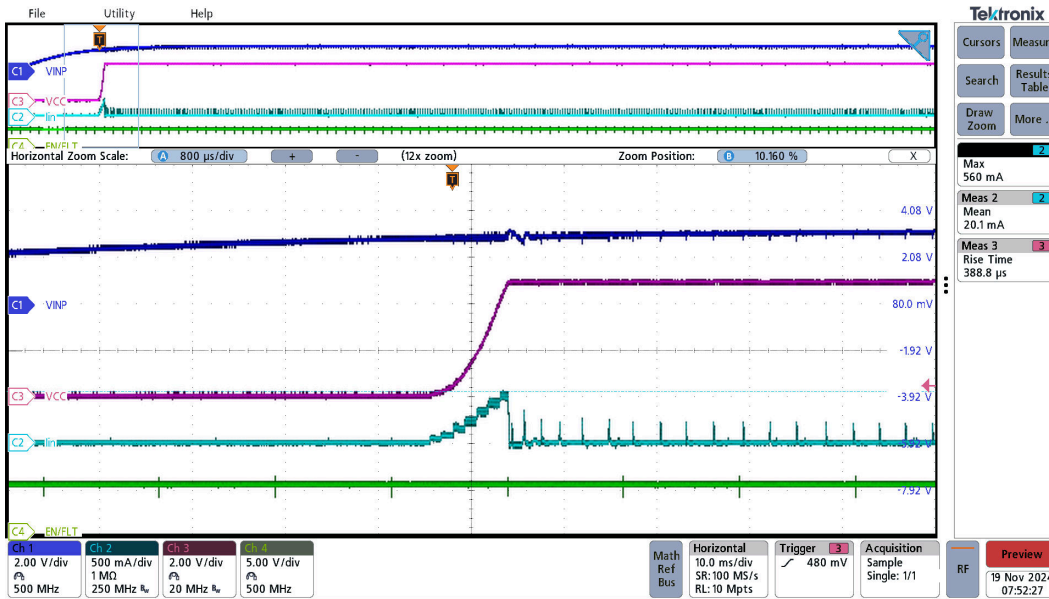

Figure 3-10. UCC33020-Q1 Start-Up, Sequence EN=5.0V → VINP=3.3V, VCC=5.0V, Iout=0mA

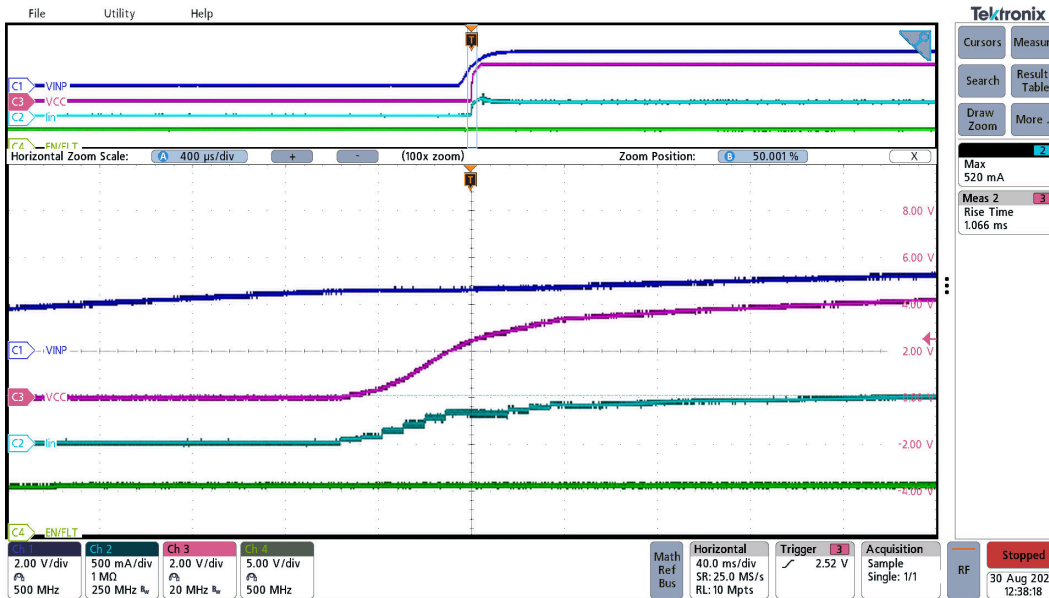

Figure 3-11. UCC33420-Q1 Start-Up, Sequence EN=5.0V → VINP=5.0V, VCC=5.0V, Rload=18Ω

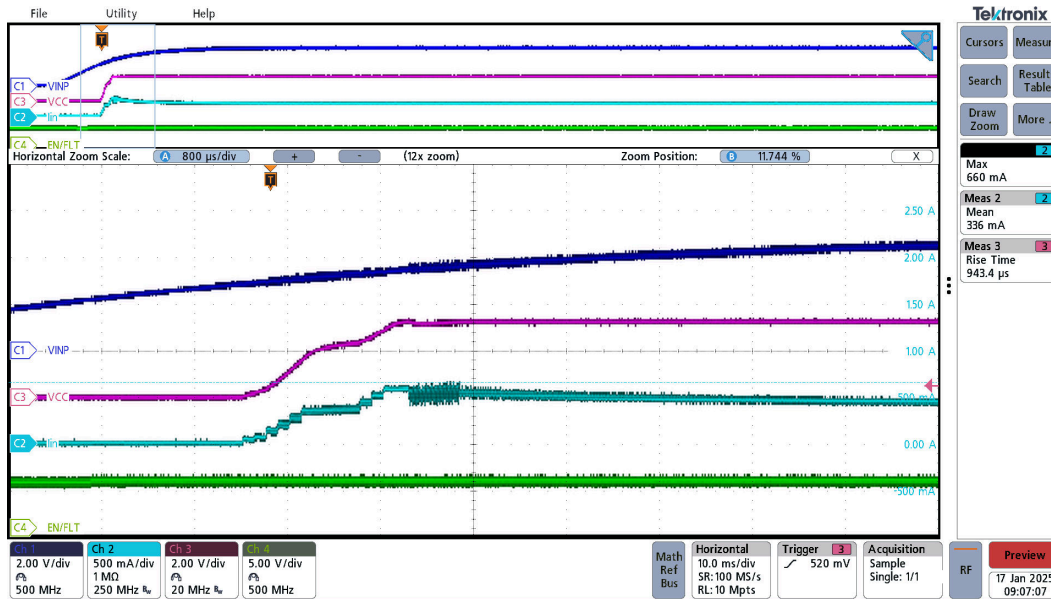

Figure 3-12. UCC33410-Q1 Start-Up, Sequence EN=5.0V → VINP=5.0V, VCC=3.3V, Rload=10Ω

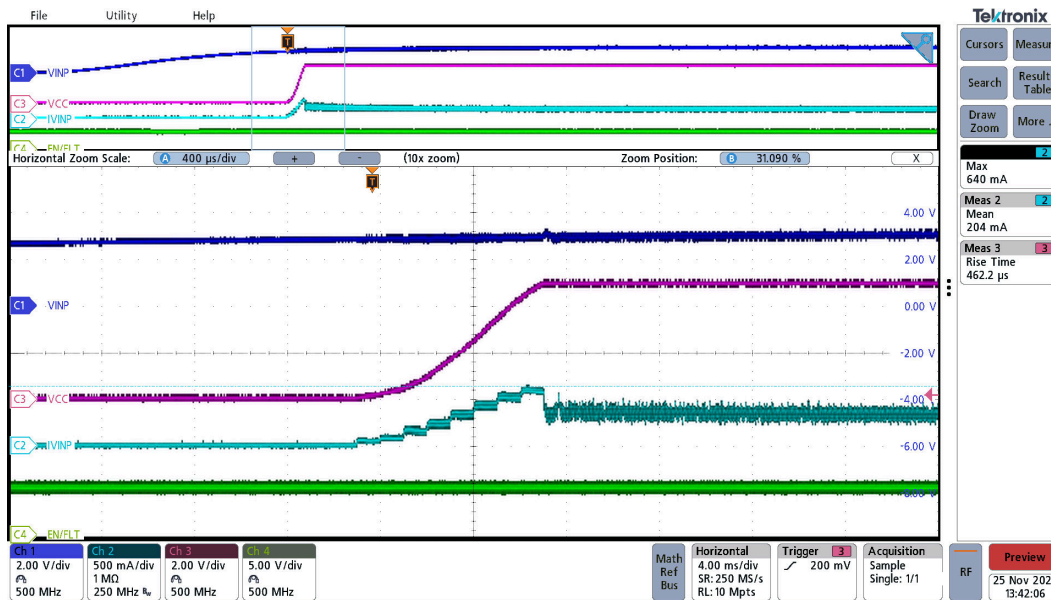

Figure 3-13. UCC33020-Q1 Start-Up, Sequence EN=5.0V → VINP=3.3V, VCC=5.0V, Rload=50Ω

3.2.4 Inrush Current

Inrush current measurements made with VINP applied first, then toggling EN pin second. The input capacitors are pre-biased to VINP and make negligible contribution to the measured inrush current.

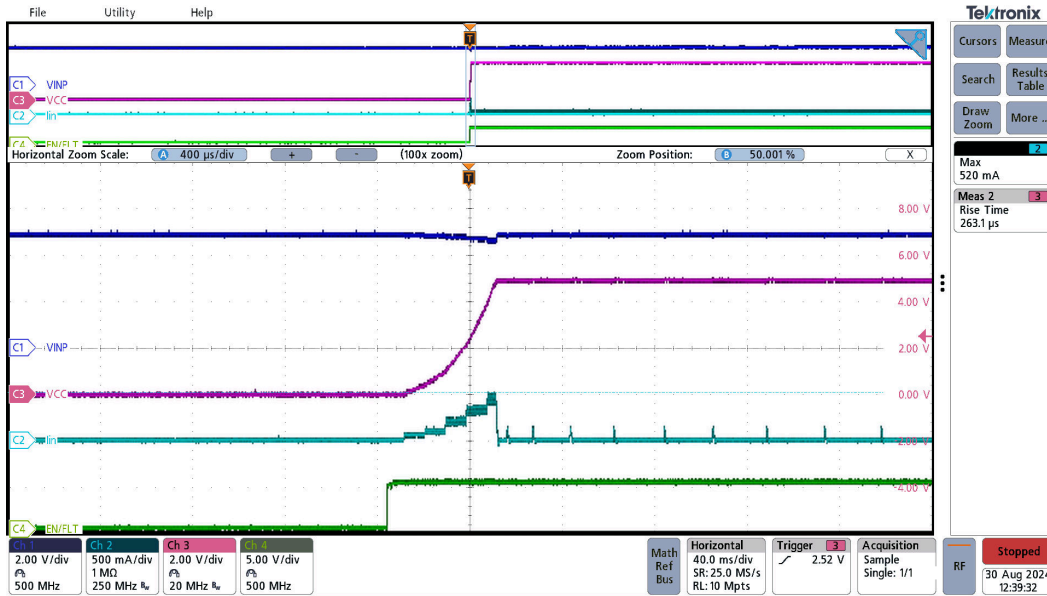

Figure 3-14. UCC33420-Q1 Inrush Current, Sequence VINP=5.0V → EN=5.0V, VCC=5.0V, Iout=0mA

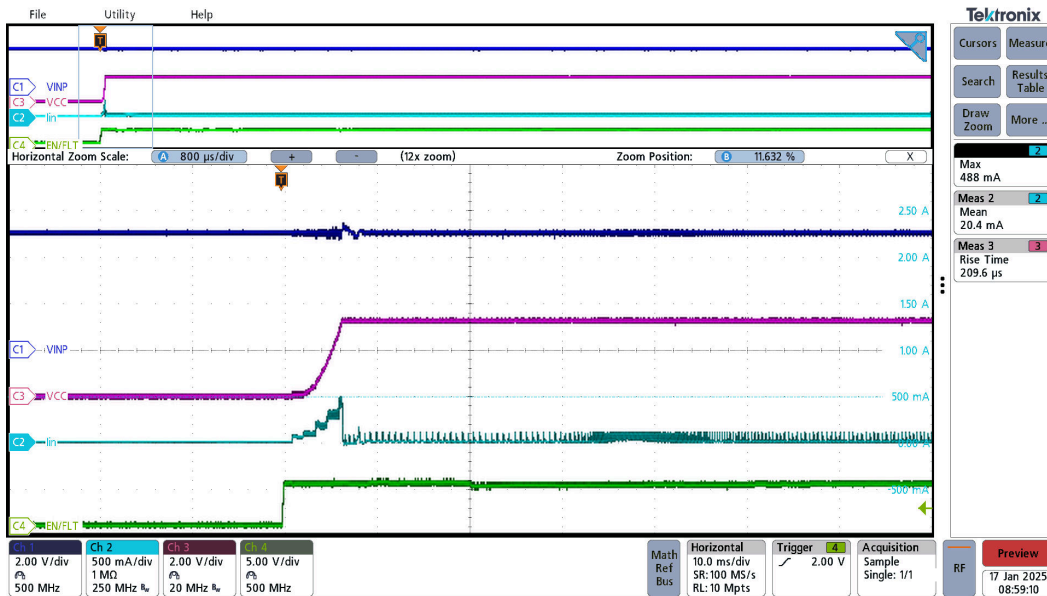

Figure 3-15. UCC33410-Q1 Inrush Current, Sequence VINP=5.0V → EN=5.0V, VCC=3.3V, Iout=0mA

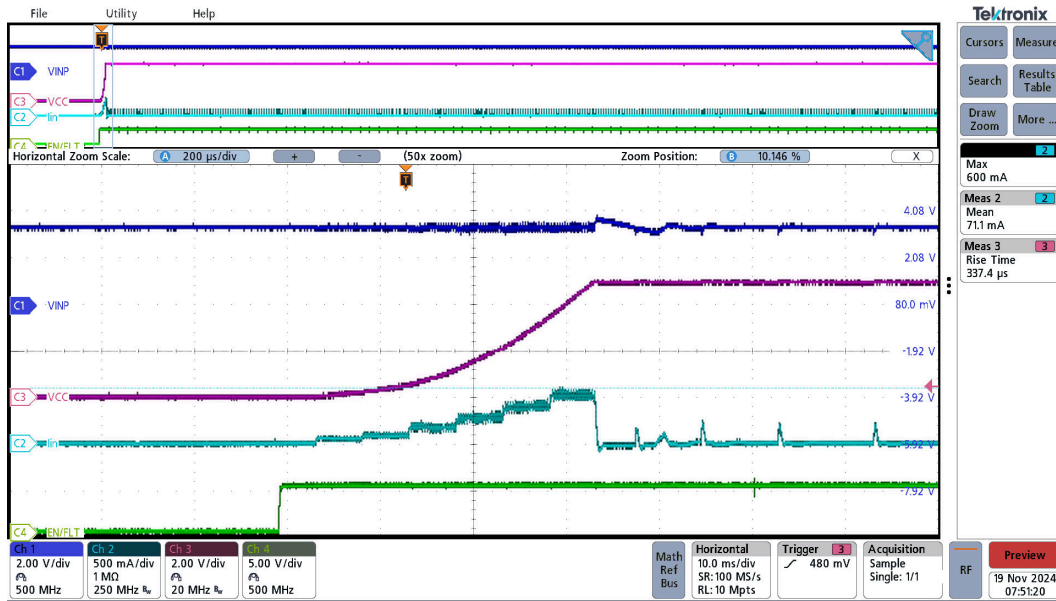

Figure 3-16. UCC33020-Q1 Inrush Current, Sequence VINP=3.3V → EN=5.0V, VCC=5.0V, Iout=0mA

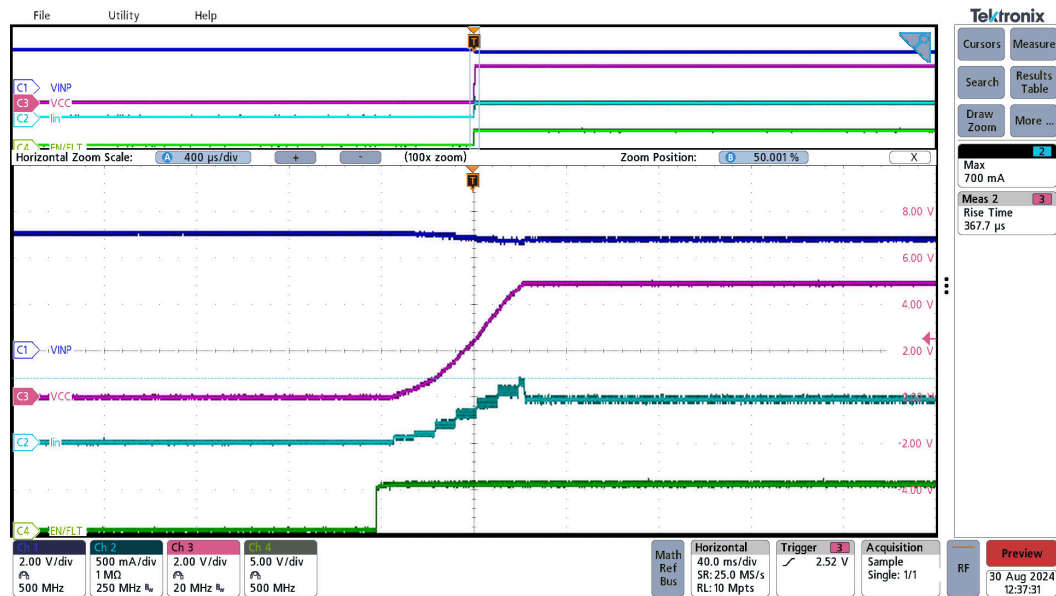

Figure 3-17. UCC33420-Q1 Inrush Current, Sequence VINP=5.0V → EN=5.0V, VCC=5.0V, Rload=18Ω

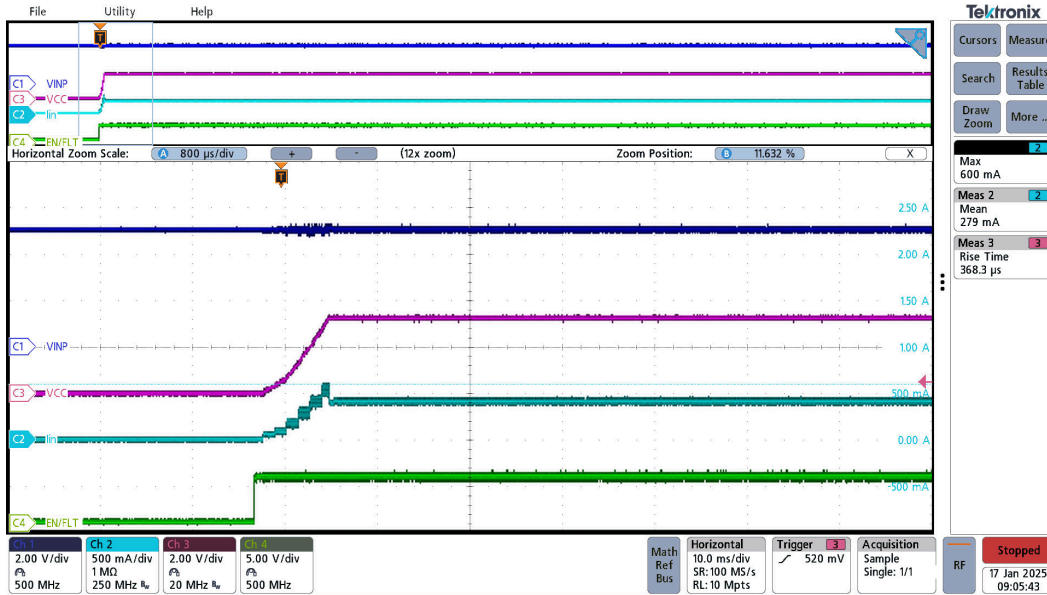

Figure 3-18. UCC33410-Q1 Inrush Current, Sequence VINP=5.0V → EN=5.0V, VCC=3.3V, Rload=10Ω

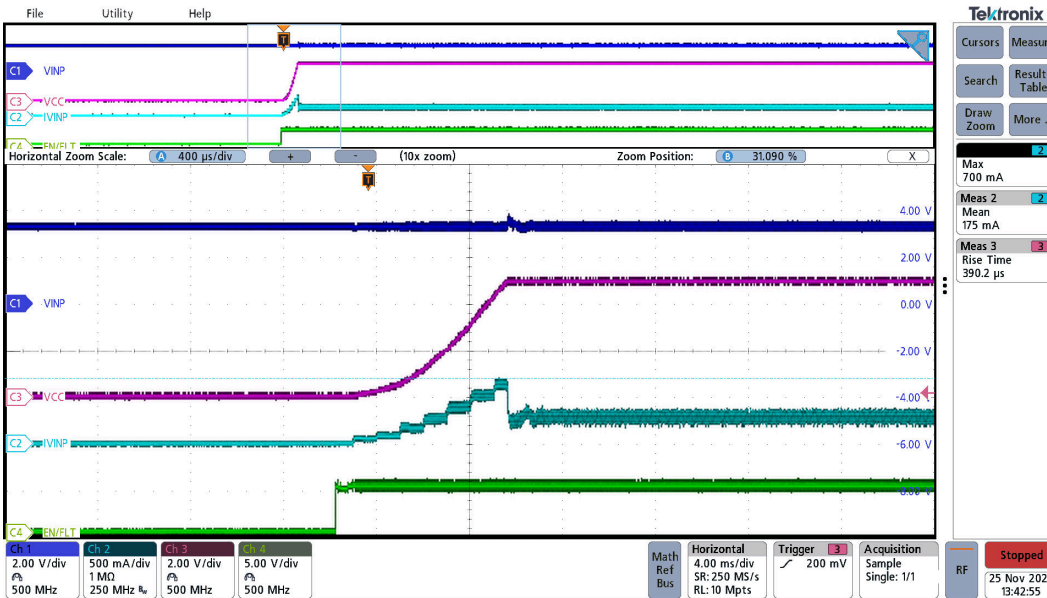

Figure 3-19. UCC33020-Q1 Inrush Current, Sequence VINP=3.3V → EN=5.0V, VCC=5.0V, Rload=50Ω

3.2.5 AC Ripple Voltage

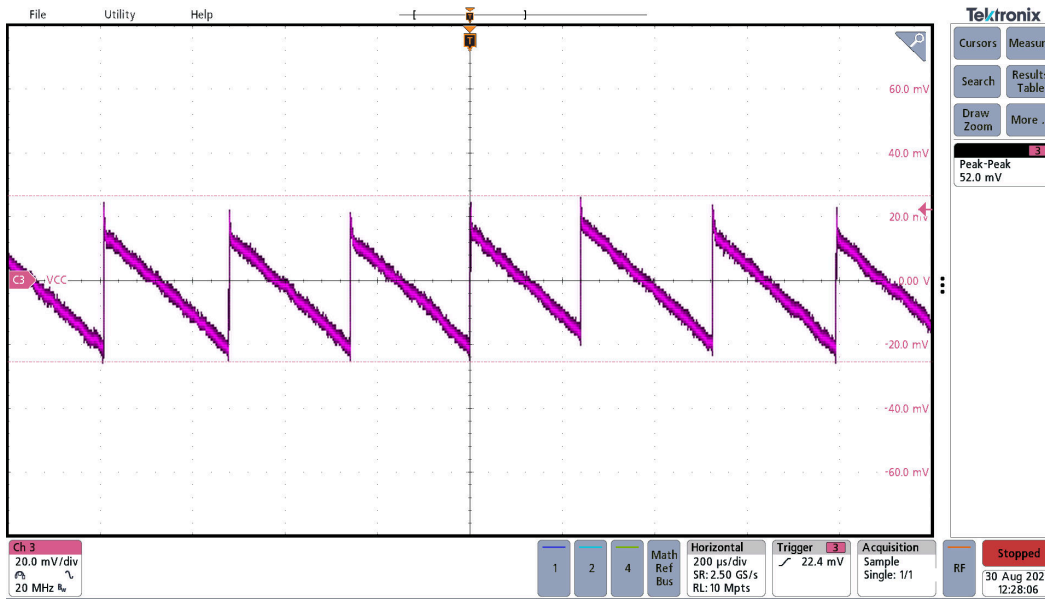

Figure 3-20. UCC33420-Q1 VCC AC Ripple, VINP=5.0V, VCC=5.0V, Iout=0mA

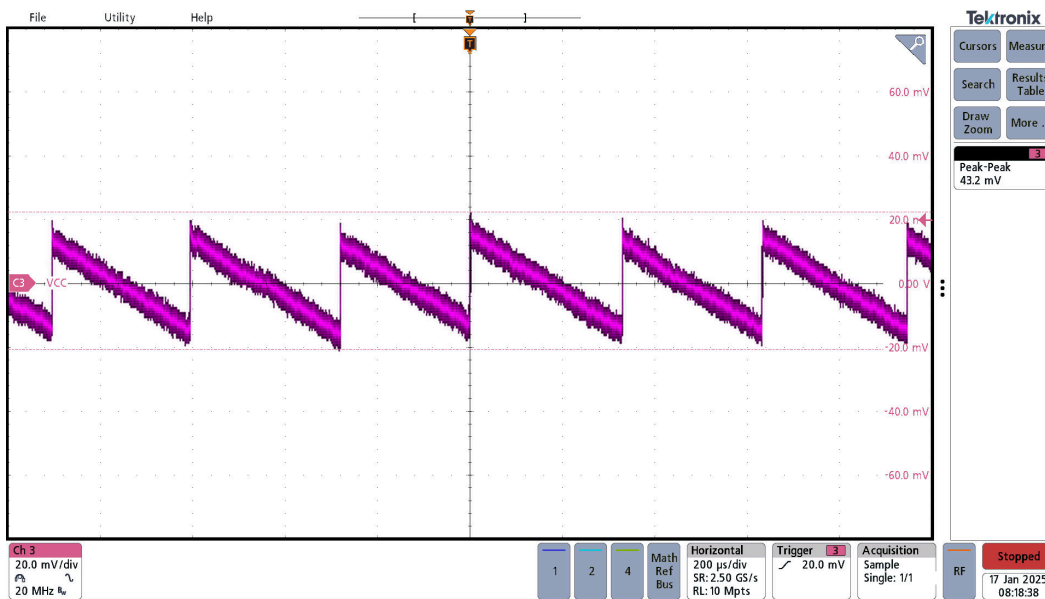

Figure 3-21. UCC33410-Q1 VCC AC Ripple, VINP=5.0V, VCC=3.3V, Iout=0mA

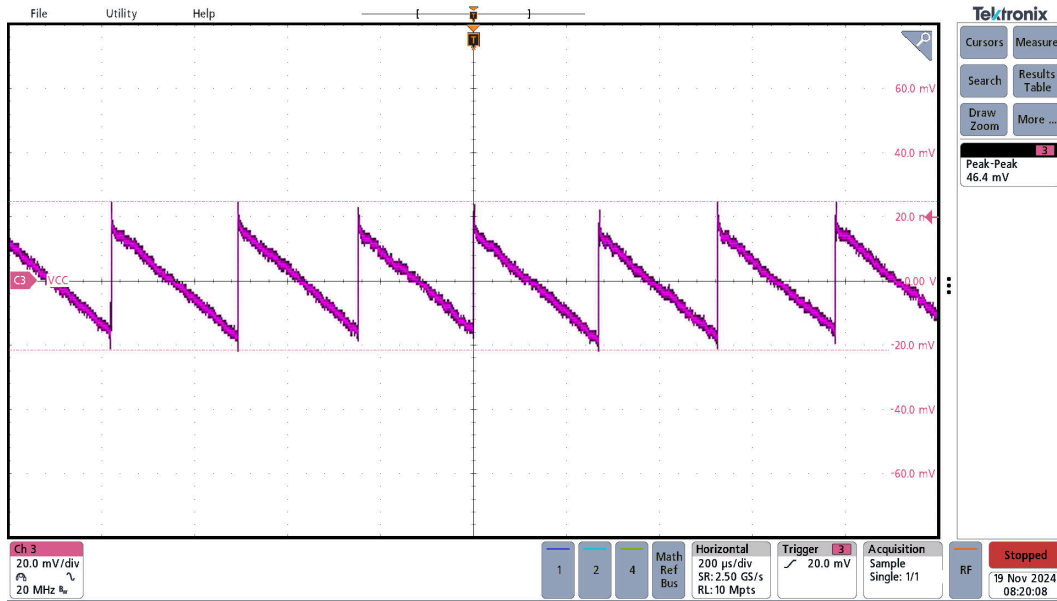

Figure 3-22. UCC33020-Q1 VCC AC Ripple, VINP=3.3V, VCC=5.0V, Iout=0mA

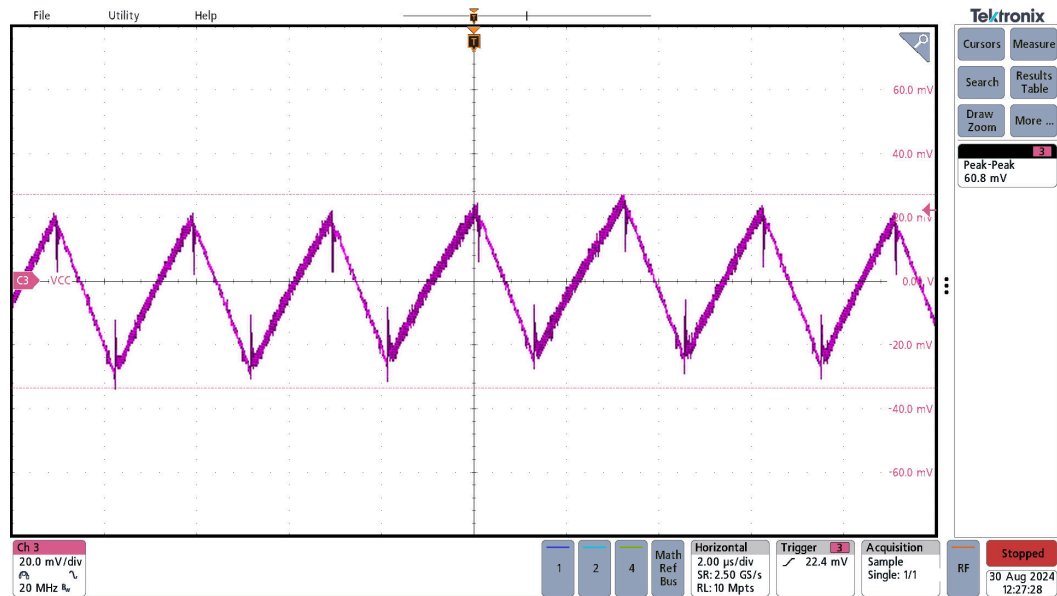

Figure 3-23. UCC33420-Q1 VCC AC Ripple, VINP=5.0V, VCC=5.0V, Iout=300mA

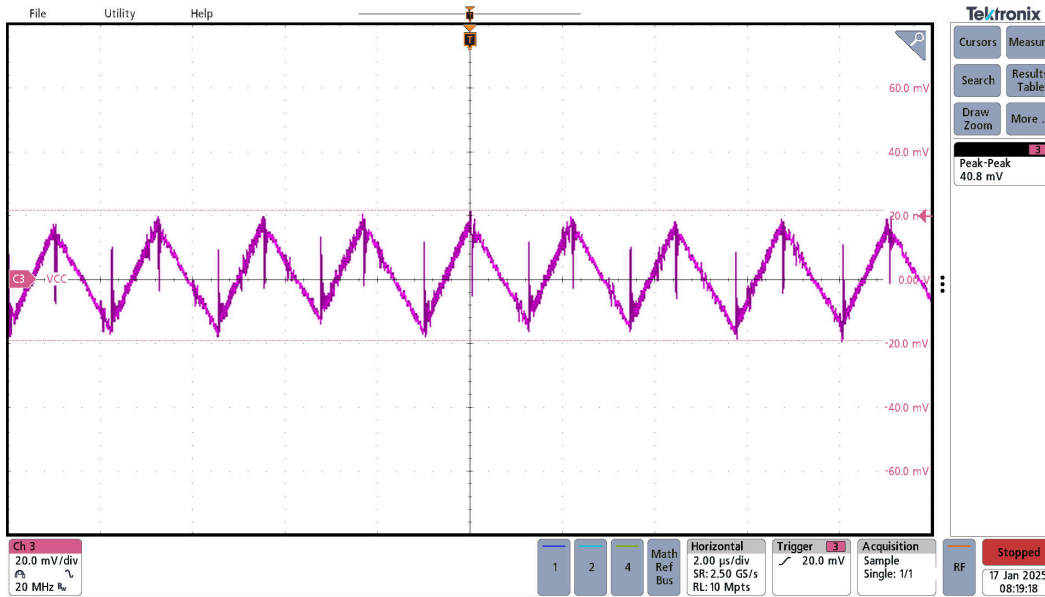

Figure 3-24. UCC33410-Q1 VCC AC Ripple, VINP=5.0V, VCC=3.3V, Iout=300mA

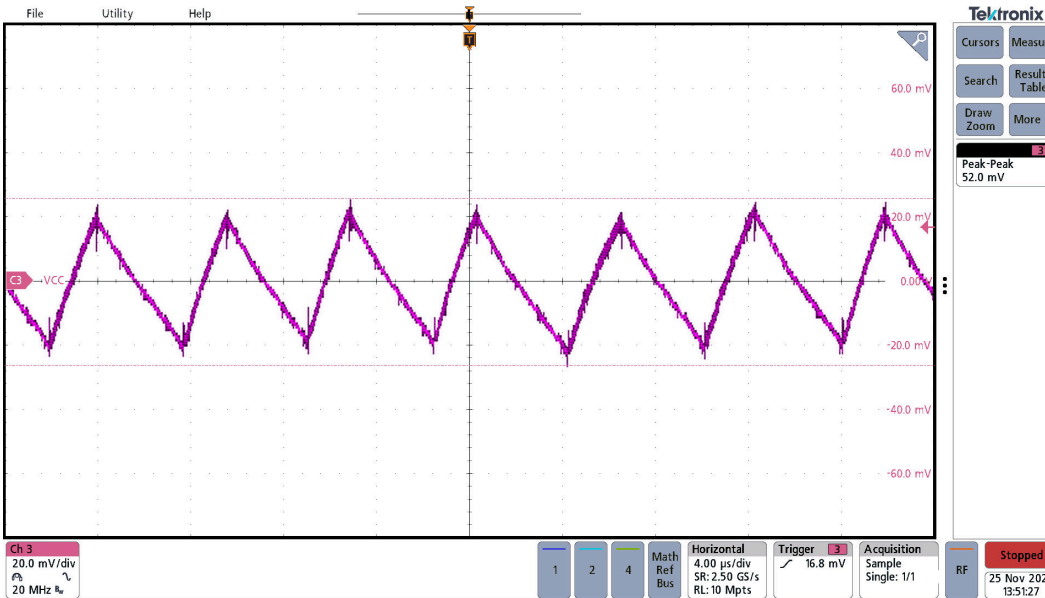

Figure 3-25. UCC33020-Q1 VCC AC Ripple, VINP=3.3V, VCC=5.0V, Iout=100mA

3.2.6 Load Transient

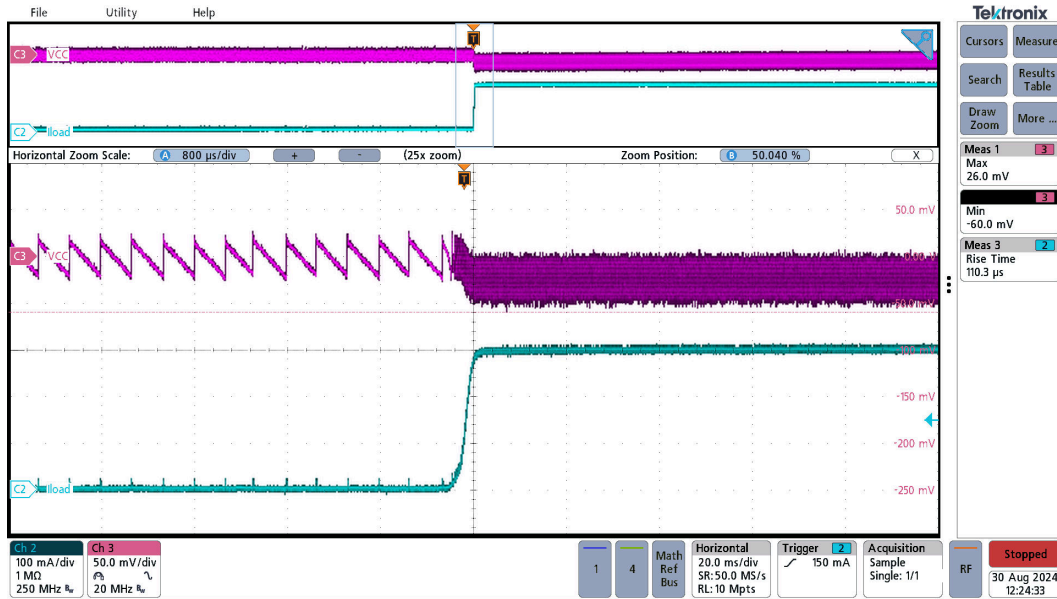

Figure 3-26. UCC33420-Q1 Load Transient, VINP=5.0V, VCC=5.0V, No Load (Iout=0mA) to Full Load (Iout=300mA)

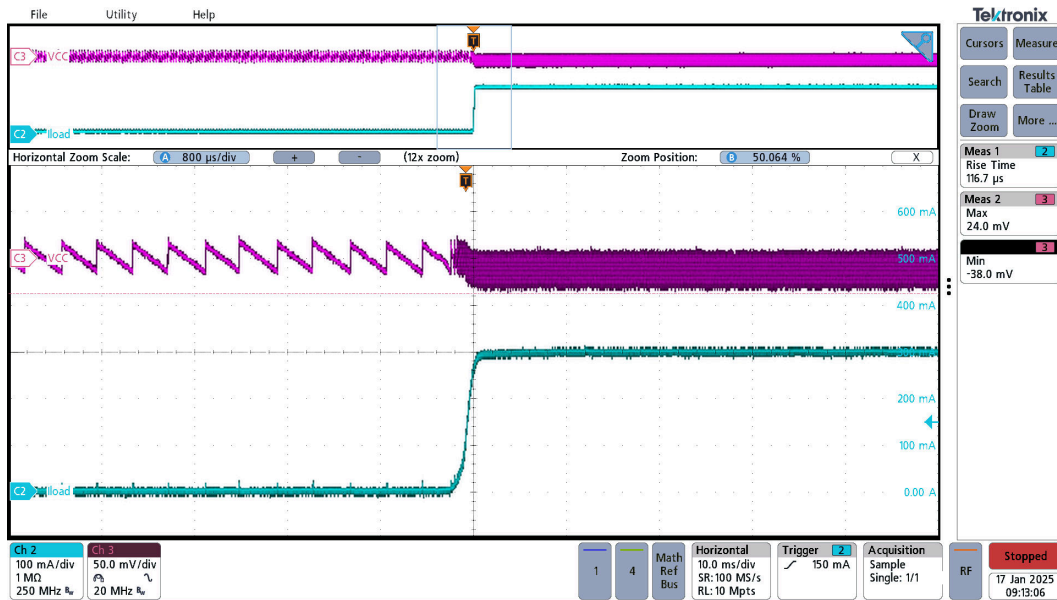

Figure 3-27. UCC33410-Q1 Load Transient, VINP=5.0V, VCC=3.3V, No Load (Iout=0mA) to Full Load (Iout=300mA)

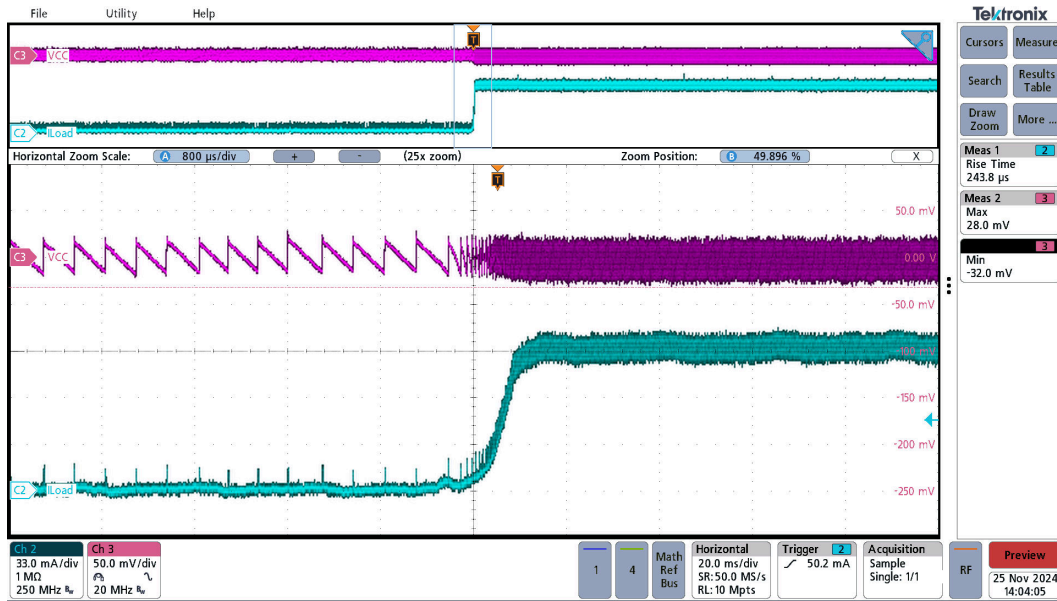

Figure 3-28. UCC33020-Q1 Load Transient, VINP=3.3V, VCC=5.0V, No Load (Iout=0mA) to Full Load (Iout=100mA)

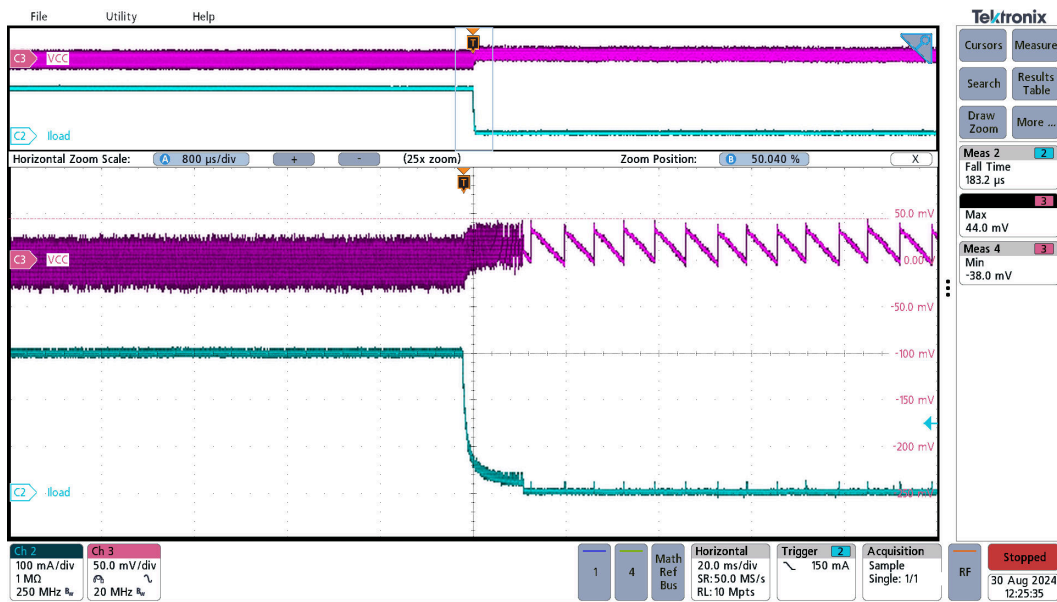

Figure 3-29. UCC33420-Q1 Load Transient, VINP=5.0V, VCC=5.0V, Full Load (Iout=300mA) to No Load (Iout=0mA)

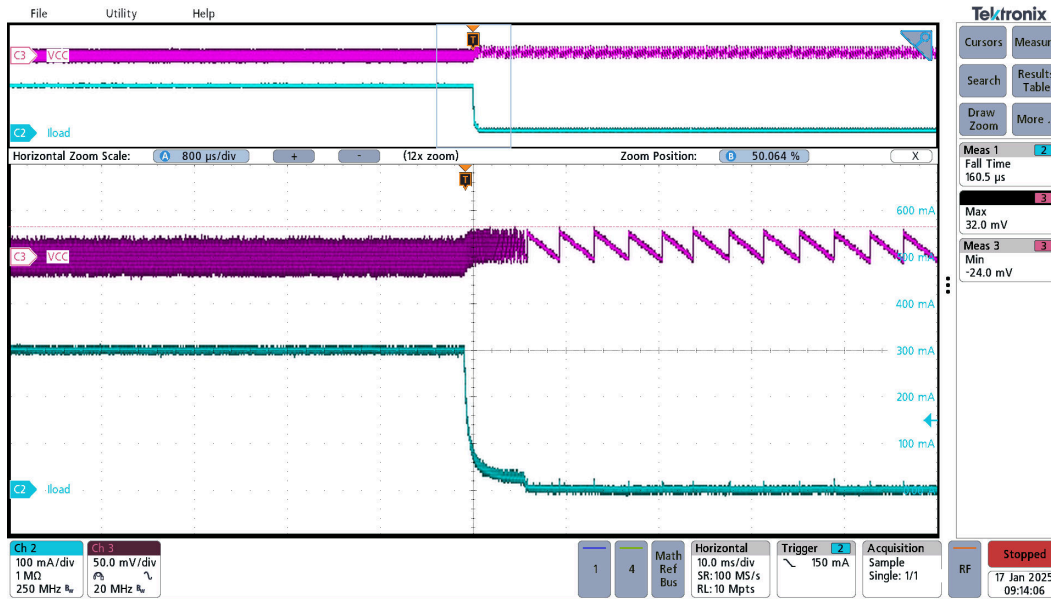

Figure 3-30. UCC33410-Q1 Load Transient, VINP=5.0V, VCC=3.3V, Full Load (Iout=300mA) to No Load (Iout=0mA)

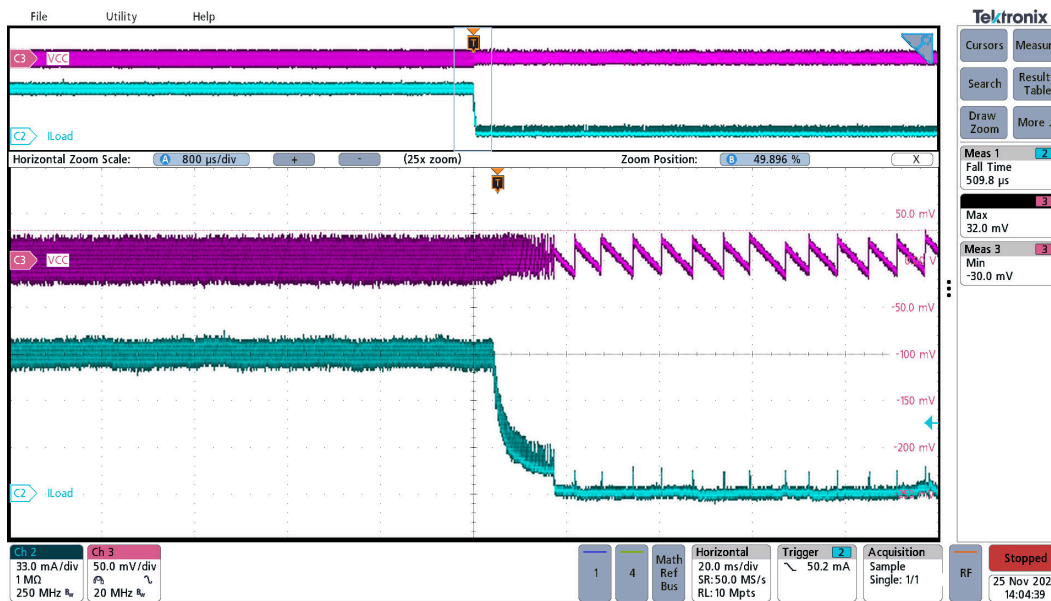

Figure 3-31. UCC33020-Q1 Load Transient, VINP=3.3V, VCC=5.0V, Full Load (Iout=100mA) to No Load (Iout=0mA)

3.2.7 VCC Short-Circuit

Short circuit is applied with an electronic load. FLT pin is pulled down during 200μs and the device tries to restart after 160ms as shown in the waveform below. Device restarts successfully after short circuit is released.

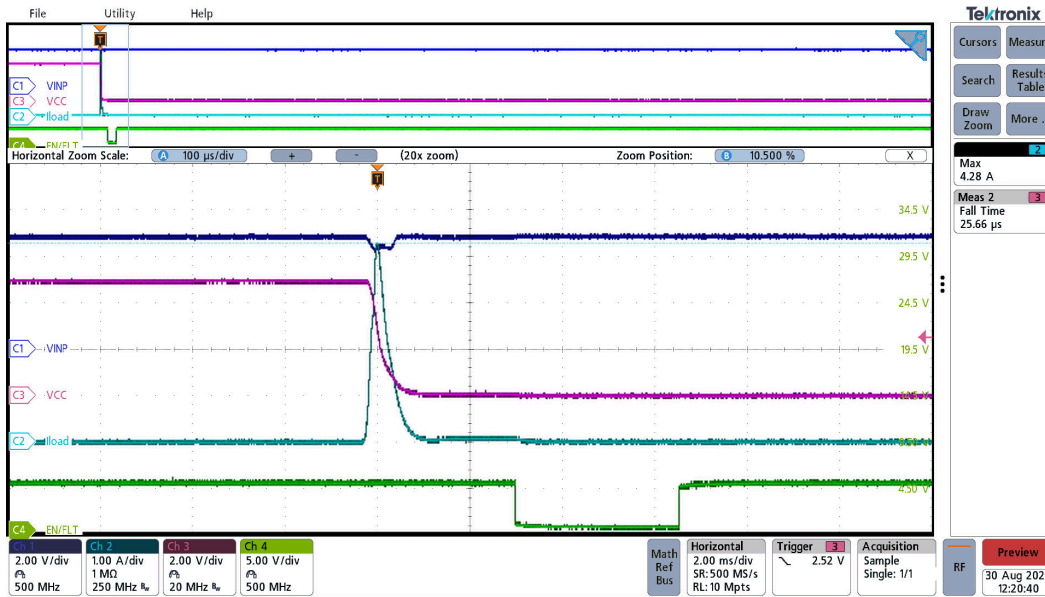

Figure 3-32. UCC33420-Q1 Short Circuit, VINP=5.0V, VCC=5.0V

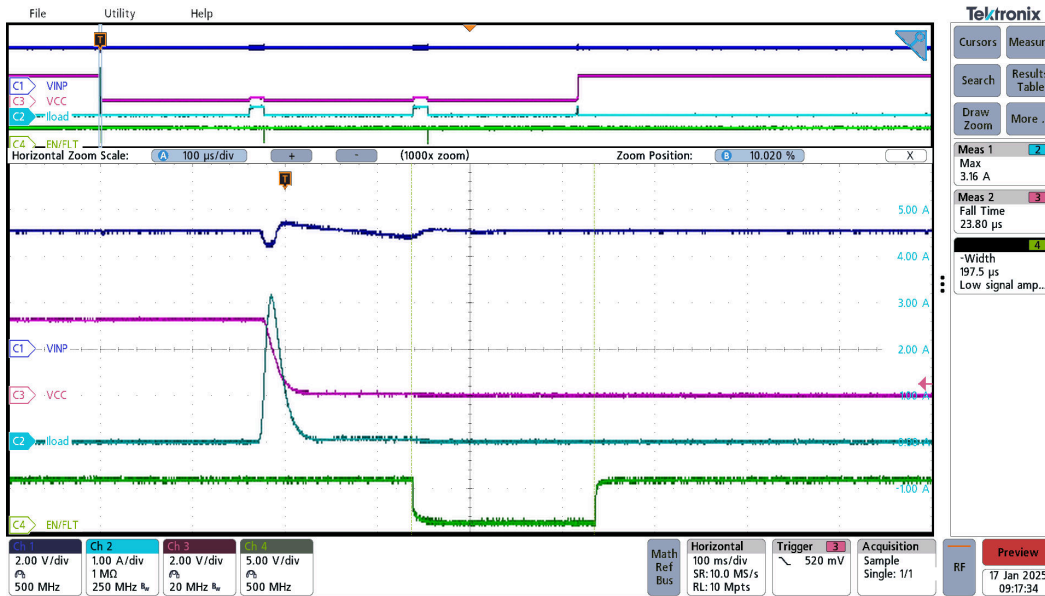

Figure 3-33. UCC33410-Q1 Short Circuit, VINP=5.0V, VCC=3.3V

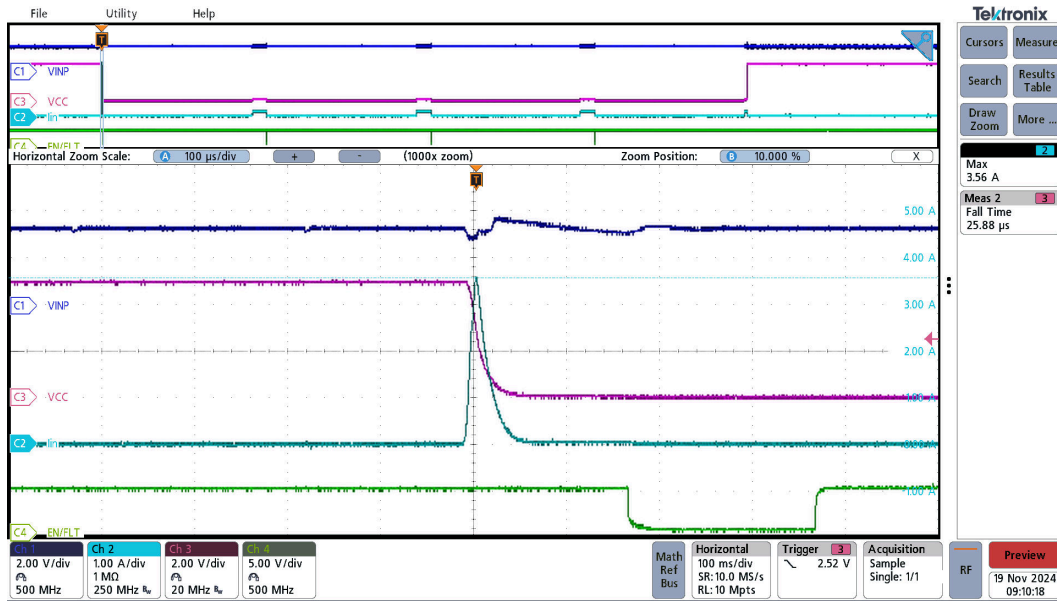

Figure 3-34. UCC33020-Q1 Short Circuit, VINP=3.3V, VCC=5.0V

3.2.8 Thermal Performance

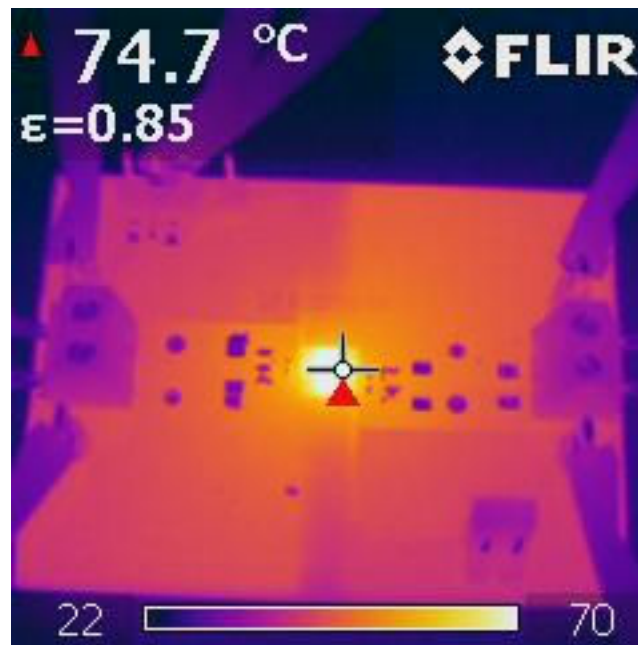

Figure 3-35. UCC33420-Q1 VINP=5.0V, VCC=5.0V, Iout=300mA, Pout=1.5W, TA=25°C

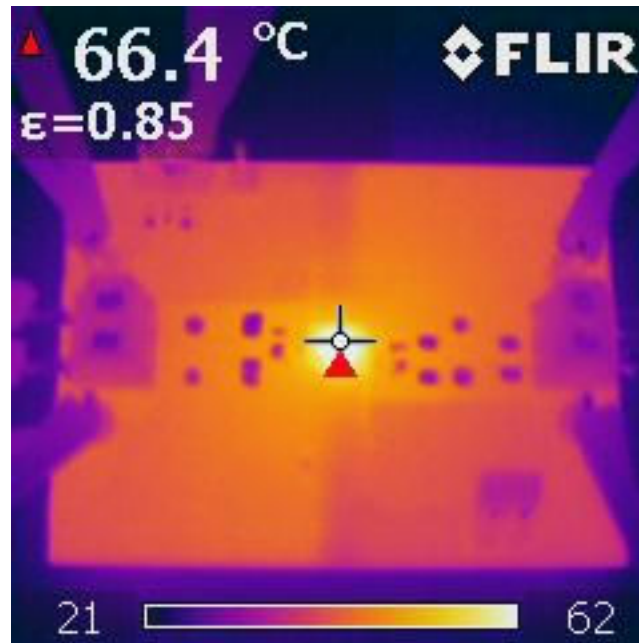

Figure 3-36. UCC33410-Q1 VINP=5.0V, VCC=3.3V, Iout=300mA, Pout=1W, TA=25°C

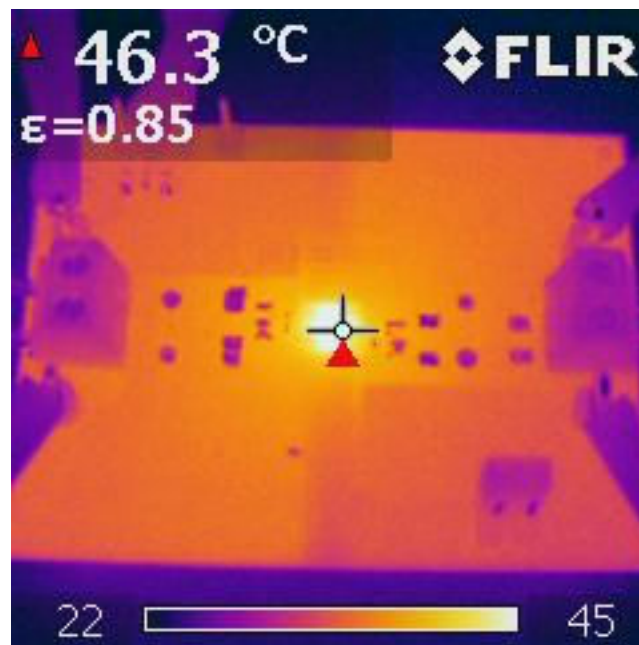

Figure 3-37. UCC33020-Q1 VINP=3.3V, VCC=5.0V, Iout=100mA, Pout=0.5W, TA=25°C

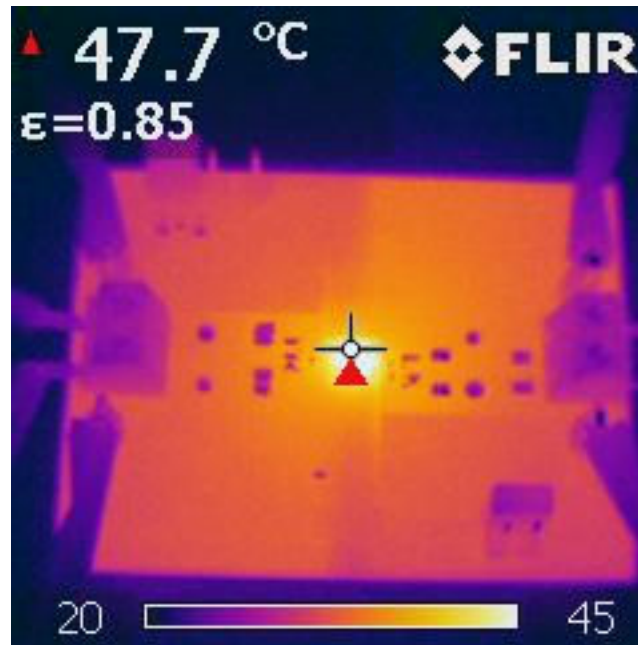

Figure 3-38. UCC33420-Q1 VINP=5.0V, VCC=5.0V, Iout=150mA, Pout=0.75W, TA=25°C

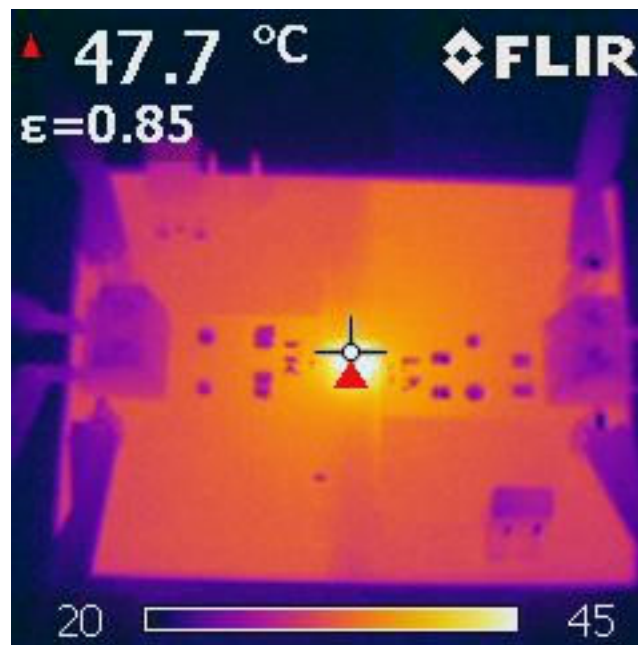

Figure 3-39. UCC33410-Q1 VINP=5.0V, VCC=3.3V, Iout=150mA, Pout=0.5W, TA=25°C

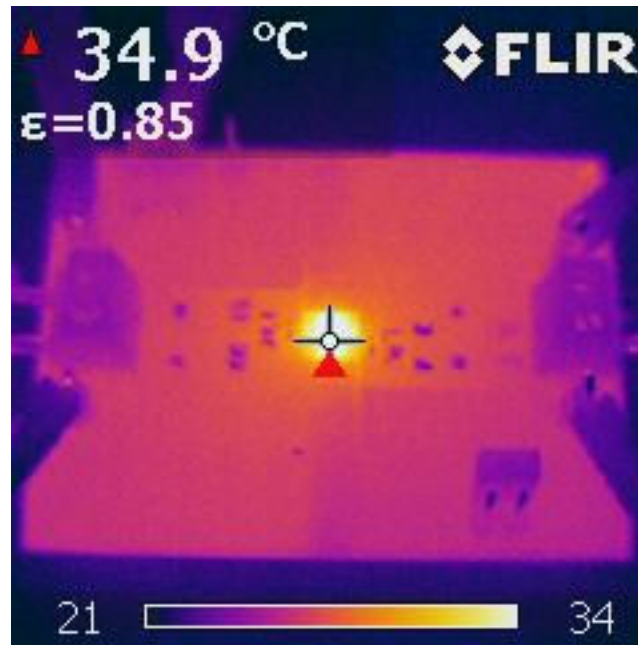

Figure 3-40. UCC33020-Q1 VINP=3.3V, VCC=5.0V, Iout=50mA, Pout=0.25W, TA=25°C

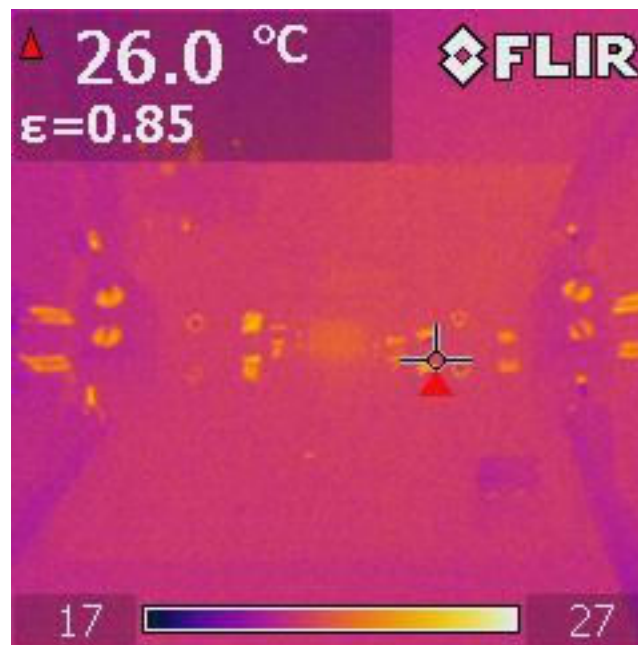

Figure 3-41. UCC33420-Q1 VINP=5.0V, VCC=5.0V, Iout=0mA, Pout=0W, TA=25°C

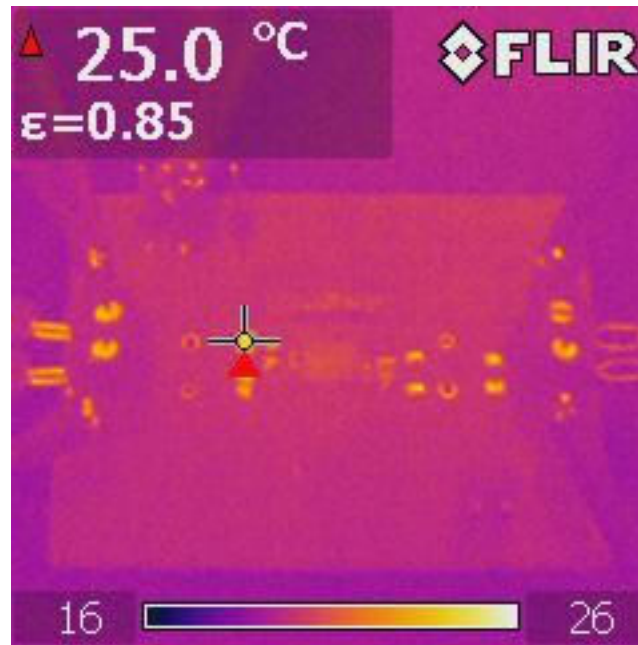

Figure 3-42. UCC33410-Q1 VINP=5.0V, VCC=3.3V, Iout=0mA, Pout=0W, TA=25°C

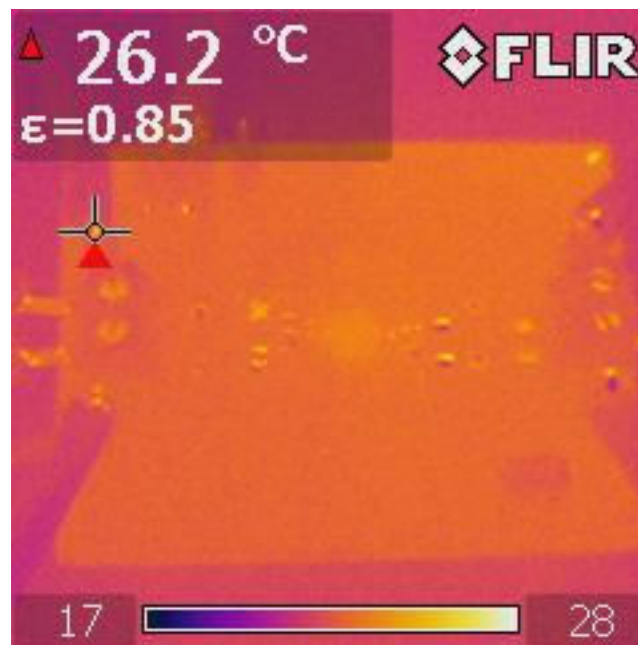

Figure 3-43. UCC33020-Q1 VINP=3.3V, VCC=5.0V, Iout=0mA, Pout=0W, TA=25°C

Note

The calibration of the thermal camera set the emissivity used on the thermal performance pictures.

4 Hardware Design Files

4.1 Assembly and Printed Circuit Board (PCB)

The UCC33420EVM-080 is designed using a four-layer, FR4, PCB, fabricated with 1-ounce copper on all four layers. The EVM PCB demonstrates the important use of ground planes and tented stitching vias for shielding and providing low impedance connection between GND layers. For higher density PCBs such as automotive traction inverters, the PCB can include several additional signal layers but similar design methodology should be applied as best as possible.

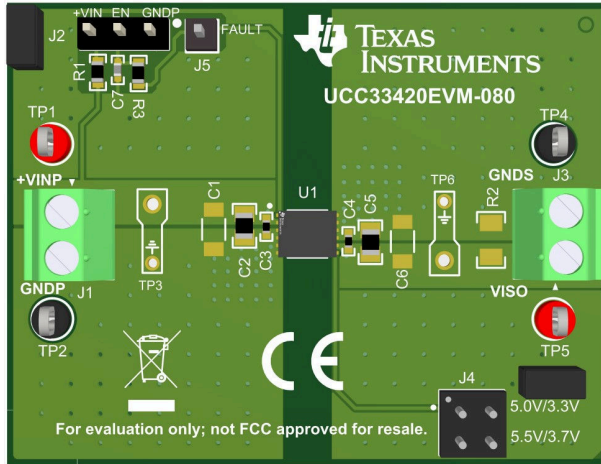

Figure 4-1. Fully Assembled 3D (top view)

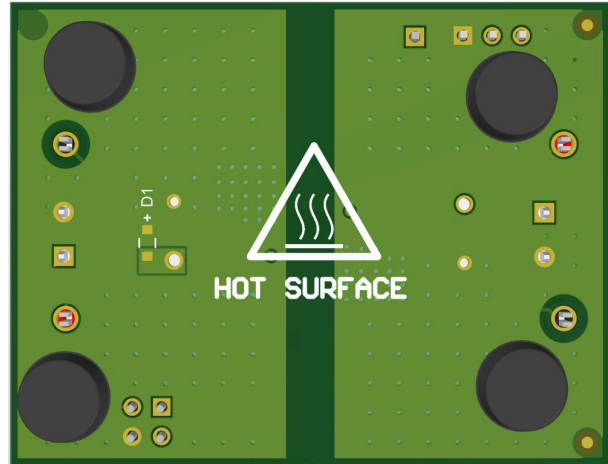

Figure 4-2. Fully Assembled 3D (bottom view)

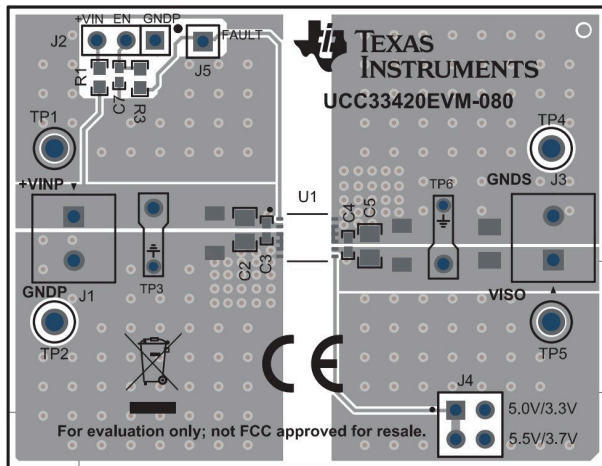

Figure 4-3. PCB Top Layer, Assembly

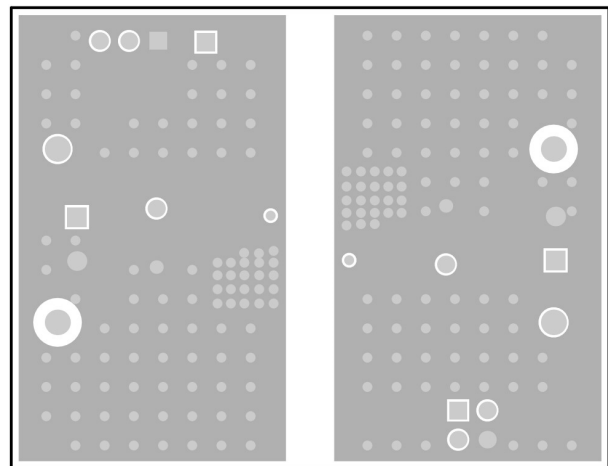

Figure 4-4. Ground Layer 2

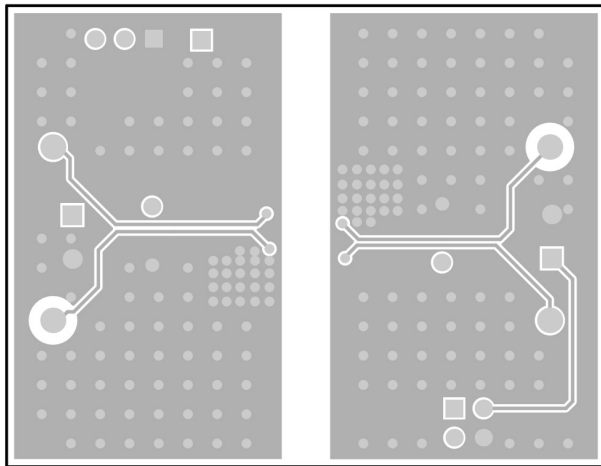

Figure 4-5. Ground Layer 3

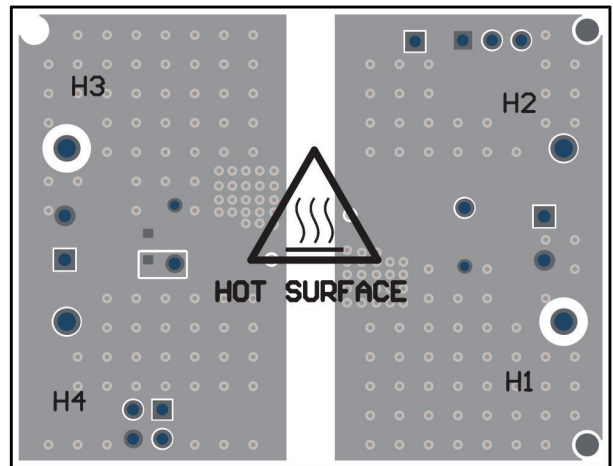

Figure 4-6. PCB Bottom Layer, Assembly (mirrored view)

4.2 Bill of Materials (BOM)

Table 4-1. Bill of Materials

Designator	Qty	Description	Part Number	Manufacturer
PCB1	1	Printed Circuit Board	HVP080E1	Any
C2	1	CAP, CERM, 10 μ F, 10V, +/- 10%, X7R, AEC-Q200 Grade 1, 0805	GCJ21BR71A106K E01L	MuRata
C3, C4	2	0.015 μ F \pm 10% 50V, Ceramic Capacitor X7R, 0402 (1005 Metric)	GCM155R71H153KA55D	MuRata
C5	1	CAP, CERM, 22 μ F, 10V, +/- 20%, X7R, 0805	GRM21BZ71A226ME15L	MuRata
C7	1	CAP, CERM, 2200pF, 50V, +/- 10%, X7R, AEC-Q200 Grade 1, 0402	GCM155R71H222KA37D	MuRata
H1, H2, H3, H4	4	Bumpers	SJ61A6	3M
J1, J3	2	Conn Term Block, 2POS, 3.81mm, TH	1727010	Phoenix Contact
J2	1	Header, 100mil, 3x1, Tin, TH	PEC03SAAN	Sullins Connector
J4	1	Header, 100mil, 2x2, Tin, TH	PEC02DAAN	Sullins Connector
J5	1	Header, 1x1, Tin, TH	PEC01SAAN	Sullins Connector
R1	1	RES, 0 Ω , 5%, 0.1 W, AEC-Q200 Grade 0, 0603	CRCW06030000Z0EA	Vishay-Dale
R3	1	RES, 18.2k Ω , 1%, 0.1W, AEC-Q200 Grade 0, 0603	CRCW060318K2FKEA	Vishay-Dale
SH-J1, SH-J2	2	Shunt, 100mil, Flash Gold, Black	SPC02SYAN	Sullins Connector
TP1, TP5	2	Test Point, Multipurpose, Red, TH	5010	Keystone
TP2, TP4	2	Test Point, Multipurpose, Black, TH	5011	Keystone
U1	1	1.5W, High-Density, >3 kVRMS Isolated DC-DC Converter	PUCC33420-Q1	Texas Instruments
U1-alt	0	1.5W, High-Density, >3 kVRMS Isolated DC-DC Converter	PUCC33420RAQR	Texas Instruments
U1-alt	0	1.5W, High-Density, >3 kVRMS Isolated DC-DC Converter	PUCC33410QRAQRQ1	Texas Instruments
U1-alt	0	1.5W, High-Density, >3 kVRMS Isolated DC-DC Converter	PUCC33410RAQR	Texas Instruments
C1, C6	0	CAP, CERM, 10 μ F, 10V, +/- 10%, X7R, AEC-Q200 Grade 1, 1206	GCM31CR71A106KA64L	MuRata
R2	0	RES, 200 Ω , 5%, 0.25W, AEC-Q200 Grade 0, 1206	CRCW1206200RJNEA	Vishay-Dale
D1	0	Zener Diode 5.94V 960mW \pm 2.61%	PLZ6V2A-G3/H	Vishay

5 Additional Information

5.1 Trademarks

All trademarks are the property of their respective owners.

6 Revision History

NOTE: Page numbers for previous revisions may differ from page numbers in the current version.

Changes from Revision C (December 2024) to Revision D (February 2025)	Page
• Added UCC33010-Q1 and UCC33010 devices to UCC33xx0-Q1 devices table.....	2
• Added UCC33410-Q1 EVM Electrical Characteristics.....	3
• Added UCC33410-Q1 Performance Data.....	8

Changes from Revision B (May 2024) to Revision C (December 2024)	Page
• Added UCC33020-Q1 and UCC33020 devices to UCC33x20-Q1 devices table.....	2
• Updated UCC33420-Q1 EVM Electrical Characteristics.....	3
• Added UCC33020-Q1 EVM Electrical Characteristics.....	3
• Updated Schematic.....	8
• Updated UCC33420-Q1 Performance Data.....	8
• Added UCC33020-Q1 Performance Data.....	8
• Updated Bill of Materials table.....	32

Changes from Revision A (May 2024) to Revision B (May 2024)	Page
• Updated <i>Applications</i> section.....	1
• Updated capacitors recommendations on Description section of <i>UCC33420-Q1 Pin Description</i> table.....	2
• Updated schematics.....	8

STANDARD TERMS FOR EVALUATION MODULES

1. *Delivery:* TI delivers TI evaluation boards, kits, or modules, including any accompanying demonstration software, components, and/or documentation which may be provided together or separately (collectively, an "EVM" or "EVMs") to the User ("User") in accordance with the terms set forth herein. User's acceptance of the EVM is expressly subject to the following terms.
 - 1.1 EVMs are intended solely for product or software developers for use in a research and development setting to facilitate feasibility evaluation, experimentation, or scientific analysis of TI semiconductor products. EVMs have no direct function and are not finished products. EVMs shall not be directly or indirectly assembled as a part or subassembly in any finished product. For clarification, any software or software tools provided with the EVM ("Software") shall not be subject to the terms and conditions set forth herein but rather shall be subject to the applicable terms that accompany such Software
 - 1.2 EVMs are not intended for consumer or household use. EVMs may not be sold, sublicensed, leased, rented, loaned, assigned, or otherwise distributed for commercial purposes by Users, in whole or in part, or used in any finished product or production system.
2. *Limited Warranty and Related Remedies/Disclaimers:*
 - 2.1 These terms do not apply to Software. The warranty, if any, for Software is covered in the applicable Software License Agreement.
 - 2.2 TI warrants that the TI EVM will conform to TI's published specifications for ninety (90) days after the date TI delivers such EVM to User. Notwithstanding the foregoing, TI shall not be liable for a nonconforming EVM if (a) the nonconformity was caused by neglect, misuse or mistreatment by an entity other than TI, including improper installation or testing, or for any EVMs that have been altered or modified in any way by an entity other than TI, (b) the nonconformity resulted from User's design, specifications or instructions for such EVMs or improper system design, or (c) User has not paid on time. Testing and other quality control techniques are used to the extent TI deems necessary. TI does not test all parameters of each EVM. User's claims against TI under this Section 2 are void if User fails to notify TI of any apparent defects in the EVMs within ten (10) business days after delivery, or of any hidden defects with ten (10) business days after the defect has been detected.
 - 2.3 TI's sole liability shall be at its option to repair or replace EVMs that fail to conform to the warranty set forth above, or credit User's account for such EVM. TI's liability under this warranty shall be limited to EVMs that are returned during the warranty period to the address designated by TI and that are determined by TI not to conform to such warranty. If TI elects to repair or replace such EVM, TI shall have a reasonable time to repair such EVM or provide replacements. Repaired EVMs shall be warranted for the remainder of the original warranty period. Replaced EVMs shall be warranted for a new full ninety (90) day warranty period.

WARNING

Evaluation Kits are intended solely for use by technically qualified, professional electronics experts who are familiar with the dangers and application risks associated with handling electrical mechanical components, systems, and subsystems.

User shall operate the Evaluation Kit within TI's recommended guidelines and any applicable legal or environmental requirements as well as reasonable and customary safeguards. Failure to set up and/or operate the Evaluation Kit within TI's recommended guidelines may result in personal injury or death or property damage. Proper set up entails following TI's instructions for electrical ratings of interface circuits such as input, output and electrical loads.

NOTE:

EXPOSURE TO ELECTROSTATIC DISCHARGE (ESD) MAY CAUSE DEGRADATION OR FAILURE OF THE EVALUATION KIT; TI RECOMMENDS STORAGE OF THE EVALUATION KIT IN A PROTECTIVE ESD BAG.

3 Regulatory Notices:

3.1 United States

3.1.1 Notice applicable to EVMs not FCC-Approved:

FCC NOTICE: This kit is designed to allow product developers to evaluate electronic components, circuitry, or software associated with the kit to determine whether to incorporate such items in a finished product and software developers to write software applications for use with the end product. This kit is not a finished product and when assembled may not be resold or otherwise marketed unless all required FCC equipment authorizations are first obtained. Operation is subject to the condition that this product not cause harmful interference to licensed radio stations and that this product accept harmful interference. Unless the assembled kit is designed to operate under part 15, part 18 or part 95 of this chapter, the operator of the kit must operate under the authority of an FCC license holder or must secure an experimental authorization under part 5 of this chapter.

3.1.2 For EVMs annotated as FCC – FEDERAL COMMUNICATIONS COMMISSION Part 15 Compliant:

CAUTION

This device complies with part 15 of the FCC Rules. Operation is subject to the following two conditions: (1) This device may not cause harmful interference, and (2) this device must accept any interference received, including interference that may cause undesired operation.

Changes or modifications not expressly approved by the party responsible for compliance could void the user's authority to operate the equipment.

FCC Interference Statement for Class A EVM devices

NOTE: This equipment has been tested and found to comply with the limits for a Class A digital device, pursuant to part 15 of the FCC Rules. These limits are designed to provide reasonable protection against harmful interference when the equipment is operated in a commercial environment. This equipment generates, uses, and can radiate radio frequency energy and, if not installed and used in accordance with the instruction manual, may cause harmful interference to radio communications. Operation of this equipment in a residential area is likely to cause harmful interference in which case the user will be required to correct the interference at his own expense.

FCC Interference Statement for Class B EVM devices

NOTE: This equipment has been tested and found to comply with the limits for a Class B digital device, pursuant to part 15 of the FCC Rules. These limits are designed to provide reasonable protection against harmful interference in a residential installation. This equipment generates, uses and can radiate radio frequency energy and, if not installed and used in accordance with the instructions, may cause harmful interference to radio communications. However, there is no guarantee that interference will not occur in a particular installation. If this equipment does cause harmful interference to radio or television reception, which can be determined by turning the equipment off and on, the user is encouraged to try to correct the interference by one or more of the following measures:

- Reorient or relocate the receiving antenna.
- Increase the separation between the equipment and receiver.
- Connect the equipment into an outlet on a circuit different from that to which the receiver is connected.
- Consult the dealer or an experienced radio/TV technician for help.

3.2 Canada

3.2.1 For EVMs issued with an Industry Canada Certificate of Conformance to RSS-210 or RSS-247

Concerning EVMs Including Radio Transmitters:

This device complies with Industry Canada license-exempt RSSs. Operation is subject to the following two conditions:

(1) this device may not cause interference, and (2) this device must accept any interference, including interference that may cause undesired operation of the device.

Concernant les EVMs avec appareils radio:

Le présent appareil est conforme aux CNR d'Industrie Canada applicables aux appareils radio exempts de licence. L'exploitation est autorisée aux deux conditions suivantes: (1) l'appareil ne doit pas produire de brouillage, et (2) l'utilisateur de l'appareil doit accepter tout brouillage radioélectrique subi, même si le brouillage est susceptible d'en compromettre le fonctionnement.

Concerning EVMs Including Detachable Antennas:

Under Industry Canada regulations, this radio transmitter may only operate using an antenna of a type and maximum (or lesser) gain approved for the transmitter by Industry Canada. To reduce potential radio interference to other users, the antenna type and its gain should be so chosen that the equivalent isotropically radiated power (e.i.r.p.) is not more than that necessary for successful communication. This radio transmitter has been approved by Industry Canada to operate with the antenna types listed in the user guide with the maximum permissible gain and required antenna impedance for each antenna type indicated. Antenna types not included in this list, having a gain greater than the maximum gain indicated for that type, are strictly prohibited for use with this device.

Concernant les EVMs avec antennes détachables

Conformément à la réglementation d'Industrie Canada, le présent émetteur radio peut fonctionner avec une antenne d'un type et d'un gain maximal (ou inférieur) approuvé pour l'émetteur par Industrie Canada. Dans le but de réduire les risques de brouillage radioélectrique à l'intention des autres utilisateurs, il faut choisir le type d'antenne et son gain de sorte que la puissance isotrope rayonnée équivalente (p.i.r.e.) ne dépasse pas l'intensité nécessaire à l'établissement d'une communication satisfaisante. Le présent émetteur radio a été approuvé par Industrie Canada pour fonctionner avec les types d'antenne énumérés dans le manuel d'usage et ayant un gain admissible maximal et l'impédance requise pour chaque type d'antenne. Les types d'antenne non inclus dans cette liste, ou dont le gain est supérieur au gain maximal indiqué, sont strictement interdits pour l'exploitation de l'émetteur.

3.3 Japan

3.3.1 *Notice for EVMs delivered in Japan:* Please see http://www.tij.co.jp/lstds/ti_ja/general/eStore/notice_01.page 日本国内に輸入される評価用キット、ボードについては、次のところをご覧ください。

<https://www.ti.com/ja-jp/legal/notice-for-evaluation-kits-delivered-in-japan.html>

3.3.2 *Notice for Users of EVMs Considered "Radio Frequency Products" in Japan:* EVMs entering Japan may not be certified by TI as conforming to Technical Regulations of Radio Law of Japan.

If User uses EVMs in Japan, not certified to Technical Regulations of Radio Law of Japan, User is required to follow the instructions set forth by Radio Law of Japan, which includes, but is not limited to, the instructions below with respect to EVMs (which for the avoidance of doubt are stated strictly for convenience and should be verified by User):

1. Use EVMs in a shielded room or any other test facility as defined in the notification #173 issued by Ministry of Internal Affairs and Communications on March 28, 2006, based on Sub-section 1.1 of Article 6 of the Ministry's Rule for Enforcement of Radio Law of Japan,
2. Use EVMs only after User obtains the license of Test Radio Station as provided in Radio Law of Japan with respect to EVMs, or
3. Use of EVMs only after User obtains the Technical Regulations Conformity Certification as provided in Radio Law of Japan with respect to EVMs. Also, do not transfer EVMs, unless User gives the same notice above to the transferee. Please note that if User does not follow the instructions above, User will be subject to penalties of Radio Law of Japan.

【無線電波を送信する製品の開発キットをお使いになる際の注意事項】 開発キットの中には技術基準適合証明を受けていないものがあります。技術適合証明を受けていないものご使用に際しては、電波法遵守のため、以下のいずれかの措置を取っていただく必要がありますのでご注意ください。

1. 電波法施行規則第6条第1項第1号に基づく平成18年3月28日総務省告示第173号で定められた電波暗室等の試験設備でご使用いただく。
2. 実験局の免許を取得後ご使用いただく。
3. 技術基準適合証明を取得後ご使用いただく。

なお、本製品は、上記の「ご使用にあたっての注意」を譲渡先、移転先に通知しない限り、譲渡、移転できないものとします。

上記を遵守頂けない場合は、電波法の罰則が適用される可能性があることをご留意ください。日本テキサス・イ

ンスツルメンツ株式会社

東京都新宿区西新宿 6 丁目 2 4 番 1 号

西新宿三井ビル

3.3.3 *Notice for EVMs for Power Line Communication:* Please see http://www.tij.co.jp/lstds/ti_ja/general/eStore/notice_02.page

電力線搬送波通信についての開発キットをお使いになる際の注意事項については、次のところをご覧ください。 <https://www.ti.com/ja-jp/legal/notice-for-evaluation-kits-for-power-line-communication.html>

3.4 European Union

3.4.1 *For EVMs subject to EU Directive 2014/30/EU (Electromagnetic Compatibility Directive):*

This is a class A product intended for use in environments other than domestic environments that are connected to a low-voltage power-supply network that supplies buildings used for domestic purposes. In a domestic environment this product may cause radio interference in which case the user may be required to take adequate measures.

-
4. *EVM Use Restrictions and Warnings:*
 - 4.1 EVMS ARE NOT FOR USE IN FUNCTIONAL SAFETY AND/OR SAFETY CRITICAL EVALUATIONS, INCLUDING BUT NOT LIMITED TO EVALUATIONS OF LIFE SUPPORT APPLICATIONS.
 - 4.2 User must read and apply the user guide and other available documentation provided by TI regarding the EVM prior to handling or using the EVM, including without limitation any warning or restriction notices. The notices contain important safety information related to, for example, temperatures and voltages.
 - 4.3 *Safety-Related Warnings and Restrictions:*
 - 4.3.1 User shall operate the EVM within TI's recommended specifications and environmental considerations stated in the user guide, other available documentation provided by TI, and any other applicable requirements and employ reasonable and customary safeguards. Exceeding the specified performance ratings and specifications (including but not limited to input and output voltage, current, power, and environmental ranges) for the EVM may cause personal injury or death, or property damage. If there are questions concerning performance ratings and specifications, User should contact a TI field representative prior to connecting interface electronics including input power and intended loads. Any loads applied outside of the specified output range may also result in unintended and/or inaccurate operation and/or possible permanent damage to the EVM and/or interface electronics. Please consult the EVM user guide prior to connecting any load to the EVM output. If there is uncertainty as to the load specification, please contact a TI field representative. During normal operation, even with the inputs and outputs kept within the specified allowable ranges, some circuit components may have elevated case temperatures. These components include but are not limited to linear regulators, switching transistors, pass transistors, current sense resistors, and heat sinks, which can be identified using the information in the associated documentation. When working with the EVM, please be aware that the EVM may become very warm.
 - 4.3.2 EVMs are intended solely for use by technically qualified, professional electronics experts who are familiar with the dangers and application risks associated with handling electrical mechanical components, systems, and subsystems. User assumes all responsibility and liability for proper and safe handling and use of the EVM by User or its employees, affiliates, contractors or designees. User assumes all responsibility and liability to ensure that any interfaces (electronic and/or mechanical) between the EVM and any human body are designed with suitable isolation and means to safely limit accessible leakage currents to minimize the risk of electrical shock hazard. User assumes all responsibility and liability for any improper or unsafe handling or use of the EVM by User or its employees, affiliates, contractors or designees.
 - 4.4 User assumes all responsibility and liability to determine whether the EVM is subject to any applicable international, federal, state, or local laws and regulations related to User's handling and use of the EVM and, if applicable, User assumes all responsibility and liability for compliance in all respects with such laws and regulations. User assumes all responsibility and liability for proper disposal and recycling of the EVM consistent with all applicable international, federal, state, and local requirements.
 5. *Accuracy of Information:* To the extent TI provides information on the availability and function of EVMs, TI attempts to be as accurate as possible. However, TI does not warrant the accuracy of EVM descriptions, EVM availability or other information on its websites as accurate, complete, reliable, current, or error-free.
 6. *Disclaimers:*
 - 6.1 EXCEPT AS SET FORTH ABOVE, EVMS AND ANY MATERIALS PROVIDED WITH THE EVM (INCLUDING, BUT NOT LIMITED TO, REFERENCE DESIGNS AND THE DESIGN OF THE EVM ITSELF) ARE PROVIDED "AS IS" AND "WITH ALL FAULTS." TI DISCLAIMS ALL OTHER WARRANTIES, EXPRESS OR IMPLIED, REGARDING SUCH ITEMS, INCLUDING BUT NOT LIMITED TO ANY EPIDEMIC FAILURE WARRANTY OR IMPLIED WARRANTIES OF MERCHANTABILITY OR FITNESS FOR A PARTICULAR PURPOSE OR NON-INFRINGEMENT OF ANY THIRD PARTY PATENTS, COPYRIGHTS, TRADE SECRETS OR OTHER INTELLECTUAL PROPERTY RIGHTS.
 - 6.2 EXCEPT FOR THE LIMITED RIGHT TO USE THE EVM SET FORTH HEREIN, NOTHING IN THESE TERMS SHALL BE CONSTRUED AS GRANTING OR CONFERRING ANY RIGHTS BY LICENSE, PATENT, OR ANY OTHER INDUSTRIAL OR INTELLECTUAL PROPERTY RIGHT OF TI, ITS SUPPLIERS/LICENSORS OR ANY OTHER THIRD PARTY, TO USE THE EVM IN ANY FINISHED END-USER OR READY-TO-USE FINAL PRODUCT, OR FOR ANY INVENTION, DISCOVERY OR IMPROVEMENT, REGARDLESS OF WHEN MADE, CONCEIVED OR ACQUIRED.
 7. *USER'S INDEMNITY OBLIGATIONS AND REPRESENTATIONS.* USER WILL DEFEND, INDEMNIFY AND HOLD TI, ITS LICENSORS AND THEIR REPRESENTATIVES HARMLESS FROM AND AGAINST ANY AND ALL CLAIMS, DAMAGES, LOSSES, EXPENSES, COSTS AND LIABILITIES (COLLECTIVELY, "CLAIMS") ARISING OUT OF OR IN CONNECTION WITH ANY HANDLING OR USE OF THE EVM THAT IS NOT IN ACCORDANCE WITH THESE TERMS. THIS OBLIGATION SHALL APPLY WHETHER CLAIMS ARISE UNDER STATUTE, REGULATION, OR THE LAW OF TORT, CONTRACT OR ANY OTHER LEGAL THEORY, AND EVEN IF THE EVM FAILS TO PERFORM AS DESCRIBED OR EXPECTED.
-

8. *Limitations on Damages and Liability:*

8.1 *General Limitations.* IN NO EVENT SHALL TI BE LIABLE FOR ANY SPECIAL, COLLATERAL, INDIRECT, PUNITIVE, INCIDENTAL, CONSEQUENTIAL, OR EXEMPLARY DAMAGES IN CONNECTION WITH OR ARISING OUT OF THESE TERMS OR THE USE OF THE EVMS , REGARDLESS OF WHETHER TI HAS BEEN ADVISED OF THE POSSIBILITY OF SUCH DAMAGES. EXCLUDED DAMAGES INCLUDE, BUT ARE NOT LIMITED TO, COST OF REMOVAL OR REINSTALLATION, ANCILLARY COSTS TO THE PROCUREMENT OF SUBSTITUTE GOODS OR SERVICES, RETESTING, OUTSIDE COMPUTER TIME, LABOR COSTS, LOSS OF GOODWILL, LOSS OF PROFITS, LOSS OF SAVINGS, LOSS OF USE, LOSS OF DATA, OR BUSINESS INTERRUPTION. NO CLAIM, SUIT OR ACTION SHALL BE BROUGHT AGAINST TI MORE THAN TWELVE (12) MONTHS AFTER THE EVENT THAT GAVE RISE TO THE CAUSE OF ACTION HAS OCCURRED.

8.2 *Specific Limitations.* IN NO EVENT SHALL TI'S AGGREGATE LIABILITY FROM ANY USE OF AN EVM PROVIDED HEREUNDER, INCLUDING FROM ANY WARRANTY, INDEMNITY OR OTHER OBLIGATION ARISING OUT OF OR IN CONNECTION WITH THESE TERMS, , EXCEED THE TOTAL AMOUNT PAID TO TI BY USER FOR THE PARTICULAR EVM(S) AT ISSUE DURING THE PRIOR TWELVE (12) MONTHS WITH RESPECT TO WHICH LOSSES OR DAMAGES ARE CLAIMED. THE EXISTENCE OF MORE THAN ONE CLAIM SHALL NOT ENLARGE OR EXTEND THIS LIMIT.

9. *Return Policy.* Except as otherwise provided, TI does not offer any refunds, returns, or exchanges. Furthermore, no return of EVM(s) will be accepted if the package has been opened and no return of the EVM(s) will be accepted if they are damaged or otherwise not in a resalable condition. If User feels it has been incorrectly charged for the EVM(s) it ordered or that delivery violates the applicable order, User should contact TI. All refunds will be made in full within thirty (30) working days from the return of the components(s), excluding any postage or packaging costs.

10. *Governing Law:* These terms and conditions shall be governed by and interpreted in accordance with the laws of the State of Texas, without reference to conflict-of-laws principles. User agrees that non-exclusive jurisdiction for any dispute arising out of or relating to these terms and conditions lies within courts located in the State of Texas and consents to venue in Dallas County, Texas. Notwithstanding the foregoing, any judgment may be enforced in any United States or foreign court, and TI may seek injunctive relief in any United States or foreign court.

Mailing Address: Texas Instruments, Post Office Box 655303, Dallas, Texas 75265
Copyright © 2023, Texas Instruments Incorporated

IMPORTANT NOTICE AND DISCLAIMER

TI PROVIDES TECHNICAL AND RELIABILITY DATA (INCLUDING DATA SHEETS), DESIGN RESOURCES (INCLUDING REFERENCE DESIGNS), APPLICATION OR OTHER DESIGN ADVICE, WEB TOOLS, SAFETY INFORMATION, AND OTHER RESOURCES "AS IS" AND WITH ALL FAULTS, AND DISCLAIMS ALL WARRANTIES, EXPRESS AND IMPLIED, INCLUDING WITHOUT LIMITATION ANY IMPLIED WARRANTIES OF MERCHANTABILITY, FITNESS FOR A PARTICULAR PURPOSE OR NON-INFRINGEMENT OF THIRD PARTY INTELLECTUAL PROPERTY RIGHTS.

These resources are intended for skilled developers designing with TI products. You are solely responsible for (1) selecting the appropriate TI products for your application, (2) designing, validating and testing your application, and (3) ensuring your application meets applicable standards, and any other safety, security, regulatory or other requirements.

These resources are subject to change without notice. TI grants you permission to use these resources only for development of an application that uses the TI products described in the resource. Other reproduction and display of these resources is prohibited. No license is granted to any other TI intellectual property right or to any third party intellectual property right. TI disclaims responsibility for, and you will fully indemnify TI and its representatives against, any claims, damages, costs, losses, and liabilities arising out of your use of these resources.

TI's products are provided subject to [TI's Terms of Sale](#) or other applicable terms available either on [ti.com](https://www.ti.com) or provided in conjunction with such TI products. TI's provision of these resources does not expand or otherwise alter TI's applicable warranties or warranty disclaimers for TI products.

TI objects to and rejects any additional or different terms you may have proposed.

Mailing Address: Texas Instruments, Post Office Box 655303, Dallas, Texas 75265

Copyright © 2025, Texas Instruments Incorporated