

EVM User's Guide: TPS4810Q1EVM TPS4810-Q1

TPS4810-Q1 Evaluation Module for Smart High-Side Driver



Description

The TPS4810Q1EVM allows reference circuit evaluation of TI's TPS4810-Q1 smart high-side driver. The TPS4810-Q1 is a 3-V to 80-V smart high-side controller and has two strong 2-A gate drivers with separate control inputs (INP1, INP2) to drive back to back MOSFETs in common source configuration. The TPS4810-Q1 provides adjustable short circuit protection with configurable auto-retry and latch-off fault behavior.

Features

- 3-V to 80-V operating voltage range
- 20-A to 50-A adjustable short circuit protection using onboard jumpers
- Selectable high-side or low-side current sense configuration
- Programmable short-circuit protection delay
- Programmable auto-retry and latch options
- LED status indication for fault conditions

Applications

- [48-V battery management system](#)
- [DC/DC converter](#)
- [Automotive power distribution box](#)
- [Cordless power tools](#)

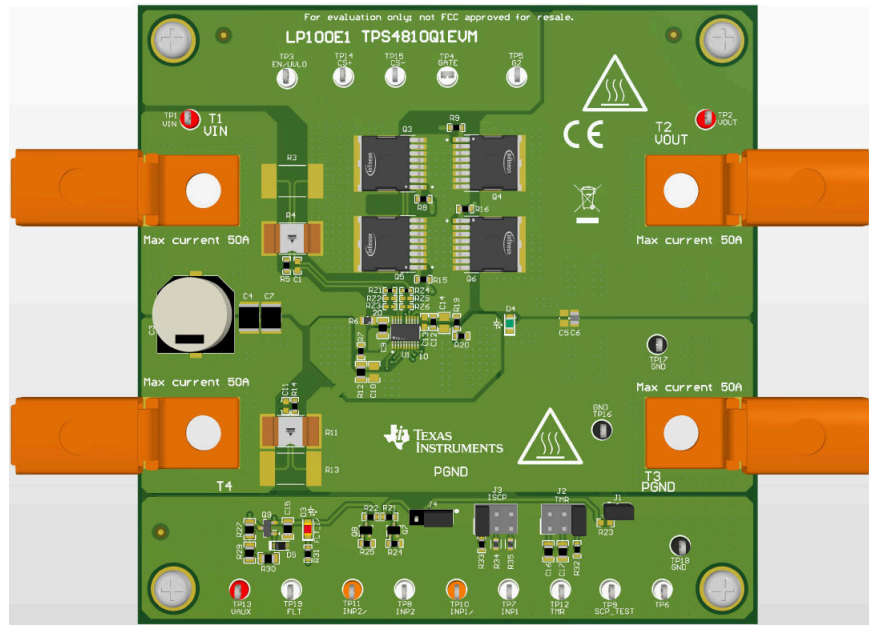

1 Evaluation Module Overview

1.1 Introduction

TPS1210-Q1 device can also be evaluated on this EVM by replacing the TPS48100QDGXRQ1 (U1) with TPS12100QDGXRQ1 and connecting EN/UVLO (TP3) to VAUX (TP13).

This user's guide describes the TPS4810-Q1 evaluation module (EVM). This guide provides configuration information, test setup details and contains the EVM schematics, bill of materials, assembly drawings, and top and bottom board layouts.



CAUTION

Hot surface. Contact can cause burns. Do not touch.

1.2 Kit Contents

Table 1-1. TPS4810Q1EVM Kit Contents

Item	Description	Quantity
TPS4810Q1EVM	PCB	1

1.3 Specification

- 24-V to 54-V (typ) operation
 - While testing for input voltage greater than 54-V, remove input 54-V TVS or use an appropriate TVS
- Current sensing options:
 - Low-side and high-side using external sense resistor (Selectable using CS_SEL pin)
 - MOSFET VDS

1.4 Device Information

The TPS4810x-Q1 family is a 100-V low IQ smart high side driver with protection and diagnostics. With wide operating voltage range of 3 V–80 V, the device is an excellent choice for 12-V, 24-V and 48-V system designs. The device can withstand and protect the loads from negative supply voltages down to –65 V. The device has two strong 2-A (src/sink) gate drivers with separate control inputs (INP1, INP2) to drive back to back MOSFETs in common source configuration. Strong GATE driving enables power switching using parallel MOSFETs in high current system designs.

The device provides adjustable short circuit protection. Auto-retry and latch-off fault behavior can be configured. By using CS+ and CS- pins, current sensing can be done either by an external sense resistor or by MOSFET VDS sensing. High side or low side current sense resistor configuration is possible by using CS_SEL pin input. The device also features diagnosis of the internal short circuit comparator using external control on SCP_TEST input.

2 Hardware

2.1 Overview

The TPS4810Q1EVM evaluation board enables evaluation of TPS48100-Q1 driver. The input power is applied between connectors T1 and T4 while T2 and T3 provide an output connection to the load. Refer to the schematic in [Figure 4-1](#) and EVM test setup in [Figure 3-1](#).

D3 provides the fault indication output for under-voltage fault, charge pump UVLO, short-circuit fault and during SCP comparator diagnosis.

Table 2-1. TPS4810Q1EVM Evaluation Board Options and Setting

Part Number	EVM Function	Vin Range	Vin UVLO	ENABLE (EN/UVLO)	Short Circuit Protection		Features
					Low Setting	Hi Setting	
TPS4810Q1EVM	Smart high side driver with reverse polarity protection, short-circuit protection and diagnostics	24V–54V	24 V	Active high	20 A	50 A	Low-side and high-side using external sense resistor MOSFET VDS sensing Short-circuit protection with auto-retry/ latch response

2.2 General Configurations

2.2.1 Physical Access

[Table 2-2](#) lists the TPS48111Q1EVM Evaluation Board input and output connector functionality. [Table 2-3](#) and [Table 2-4](#) describe the test point availability and the jumper functionality.

Table 2-2. Input and Output Connector Functionality

Connector	Label	Description
T1	VIN	Power input connector to the positive rail of the input power supply
T4	PGND	Ground connection for the power supply
T2	VOUT	Power output connector to the positive side of the load
T3	PGND	Ground connection for the load

Table 2-3. Test Points Description

Test Points	Label	Description
TP1	VIN	Input power supply to the EVM
TP2	VOUT	Output from the EVM
TP3	EN/UVLO	Enable control (Active high) and undervoltage input
TP4	GATE	GATE of the external Main MOSFET
TP5	G2	GATE of the charging MOSFET
TP6	TP6	Voltage sense node for FET diagnosis
TP7	INP1	Control input of external discharge FET
TP8	INP2	Control input of external charge FET
TP9	SCP_TEST	Internal short circuit comparator (SCP) diagnosis input.
TP10	INP1/	Inversion of control input for external discharge FET
TP11	INP2/	Inversion of control input external charge FET
TP12	TMR	Fault timer voltage
TP13	VAUX	Auxiliary supply to bias the LEDs
TP14	RS+	Positive terminal of current sense input
TP15	RS-	Negative terminal of current sense input
TP16, TP17	PGND	Power Ground
TP18	GND	Ground
TP19	FLT	Fault output

Table 2-4. Jumper and LED Descriptions

Jumper	Label	Description
J1	SCP_TEST	Internal short circuit comparator (SCP) diagnosis input. 1-2 Position disables the diagnosis function.
J2	TMR	Short-circuit protection delay setting. 1-2 Position sets 1 ms delay. 3-4 Position sets 10 ms delay. 5-6 Position sets the controller in Latch-off mode.
J3	ISCP	Short circuit protection threshold setting. 1-2 Position sets 20 A. 3-4 Position sets 30 A. 5-6 Position sets 50 A.
J4	CS_SEL	Current sense input selection. 1-2 Position selects high-side current sensing. 2-3 Position selects low-side current sensing.
D3 (RED – LED)	D3	Fault indicator. LED turns ON for under-voltage fault, short-circuit fault, charge pump UVLO and during SCP comparator diagnosis.

2.2.2 Test Equipment and Setup

2.2.2.1 Power Supplies

One adjustable power supply with 0-V to 60V- output and 0-A to 50-A output current limit.

2.2.2.2 Meters

One DMM minimum needed.

2.2.2.3 Oscilloscope

A DPO2024 or equivalent, three 10 times voltage probes, and a DC current probe.

2.2.2.4 Loads

One resistive load or equivalent that can tolerate up to 50-A DC load at 60 V and capable of the output short.

3 Implementation Results

3.1 Test Setup and Procedures

Make sure the evaluation board has default jumper settings as shown in [Table 3-1](#).

Table 3-1. Default Jumper Setting for TPS4810Q1EVM Evaluation Board

J1	J2	J3	J4
1-2	5-6	1-2	1-2

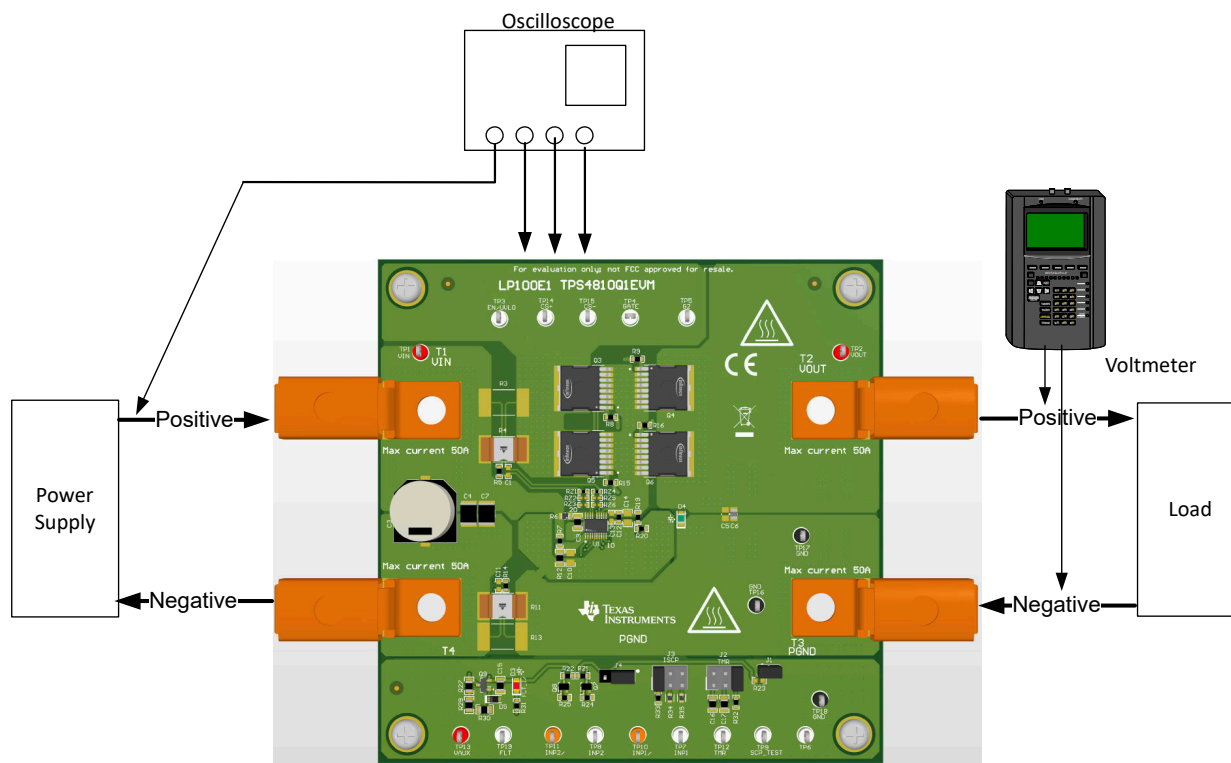

Figure 3-1. TPS4810Q1EVM Setup with Test Equipment

Follow the below instructions before starting any test and repeat again before moving to next test.

- Set the power supply output (VIN) to zero volts.
- Turn ON the power supply and set the power supply output (VIN) to 48 V, current limit = 50 A.
- Turn OFF the power supply.
- Set the jumper setting on EVM to default position as shown in [Table 3-1](#).

3.1.1 Power-up with EN Control

Use the following instructions to verify the power up profile of TPS48100-Q1.

1. Connect the EN/UVLO pin (TP3) to ground.
2. Enable the EN/UVLO to HIGH to verify the startup profile of BST, GATE and SRC.

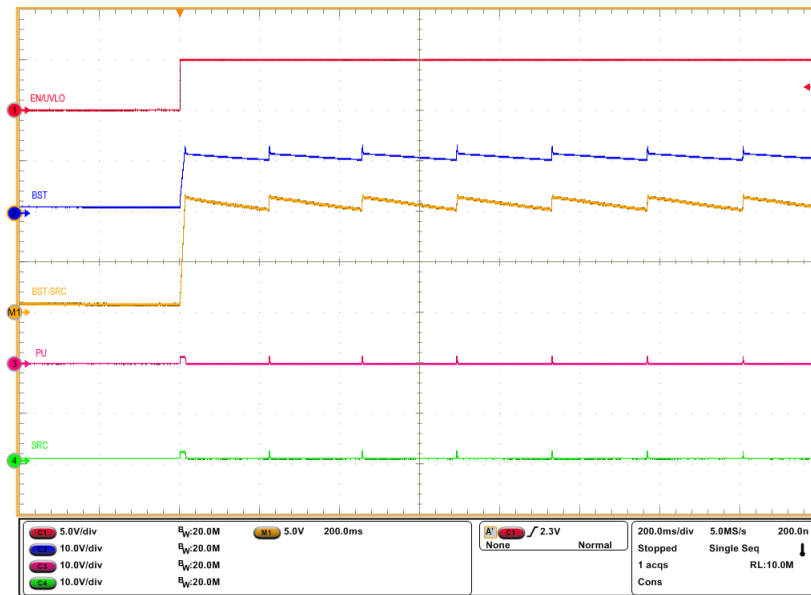

Figure 3-2. Start-Up Profile of Bootstrap Voltage with INP1=INP2 = GND, CBST = 470 nF

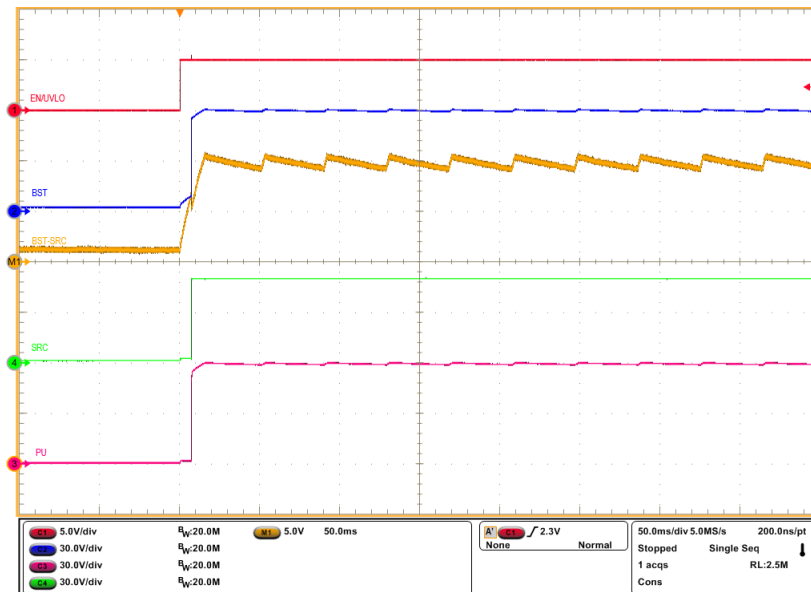

Figure 3-3. Start-Up Profile with INP1=INP2 = HIGH, CBST = 470 nF

3.1.2 Overload and Short Circuit Protection Test

Use the following instructions to perform over current test on the TPS4810Q1EVM:

1. Turn ON the power supply and set the power supply output VIN = 48 V, current limit = 50 A.
2. Set the Short Circuit Protection (SCP) threshold at 30 A by installing jumper J3 in 3-4 position and install jumper J2 in 1-2 position to set 1-ms delay.
3. Enable the control inputs (INP1 and INP2).
4. Now, load the output to 25 A with electronic load and apply a step of 10 A to observe the overload behavior of TPS4810Q-Q1.
5. Disconnect the load.
6. To perform short-circuit test, uninstall J2 to set shortest SCP delay.
7. Perform output short to capture the short-circuit behavior of TPS4810Q-Q1.

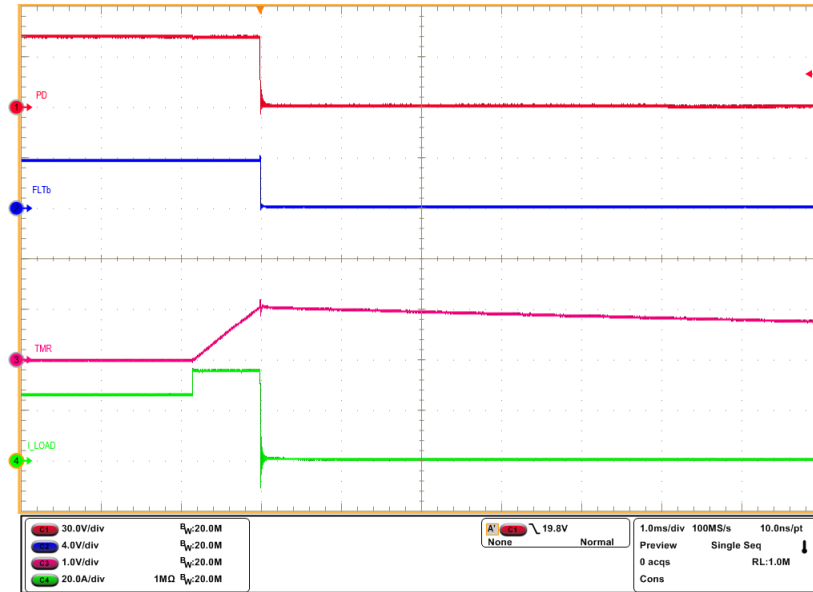

Figure 3-4. Overcurrent Response of TPS4810Q1EVM for 25-A to 35-A Load Step

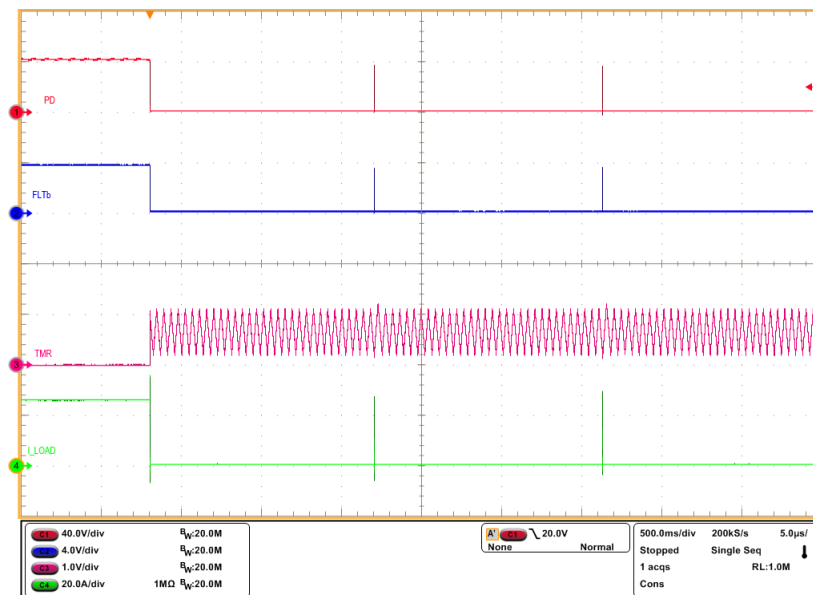

Figure 3-5. Auto-Retry Response of TPS4810Q-Q1 for an Overcurrent Fault

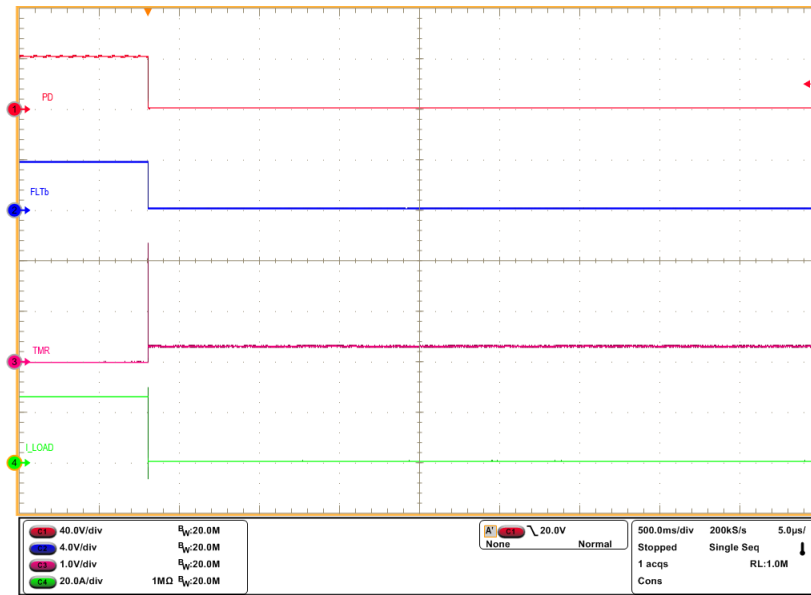

Figure 3-6. Latch-off Response of TPS4810-Q1 for an Overcurrent Fault

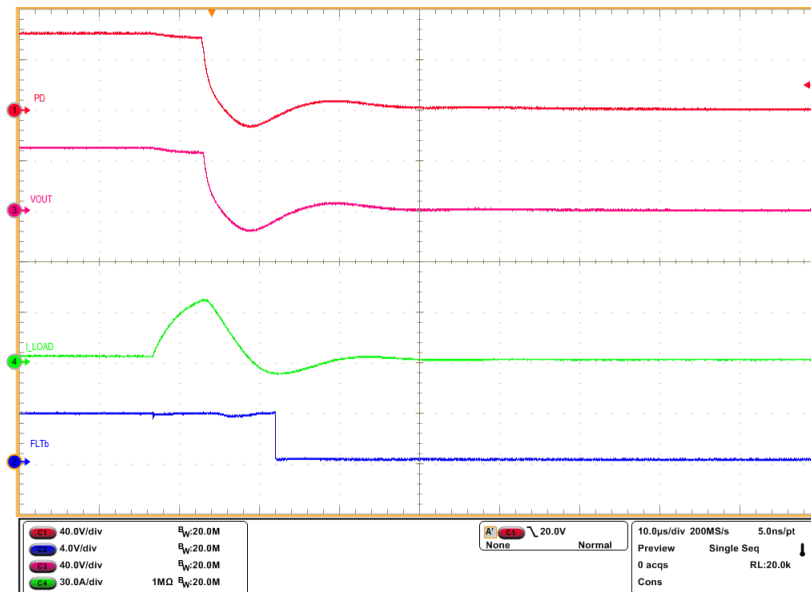

Figure 3-7. Output Short-Circuit Response of TPS4810-Q1

3.1.3 Short-Circuit Protection Diagnosis Test

Use the following instructions to perform the short circuit protection diagnosis test

1. Set the input supply voltage V_{IN} to 48 V and current limit of 10 A.
2. Enable the power supply.
3. Now, toggle the SCP_TEST (TP9) and observe the response of G1PU/PD and FLTb pins during short circuit comparator (SCP) diagnosis.

Figure 3-8 shows the SCP_TEST response of TPS48100-Q1 device.

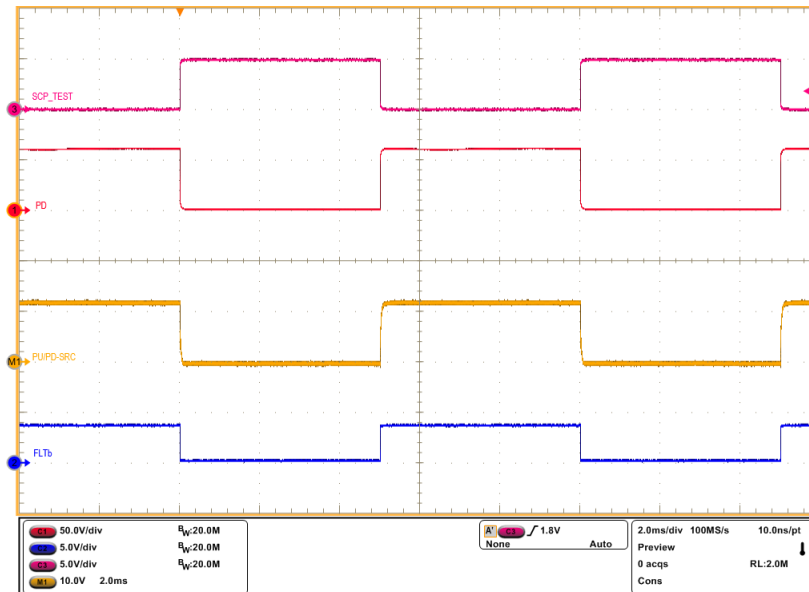

Figure 3-8. SCP_TEST Response of TPS48100-Q1

3.1.4 Input Reverse Polarity Test

Use the following instructions to test the input reverse polarity protection:

1. Set the jumper setting on EVM to default position as shown in [Table 3-1](#).
2. Set the input supply voltage VIN to 60 V and current limit of 10 A.
3. Connect the power supply positive to T4 and power supply negative to T1. The power supply is now connected in reverse polarity at the input of TPS48100-Q1.
4. Enable the power supply.
5. Observe the waveform at VOUT (TP2) with an oscilloscope.

Figure 3-9 shows input reverse polarity protection of TPS48100-Q1 on TPS4810Q1EVM Evaluation Board.

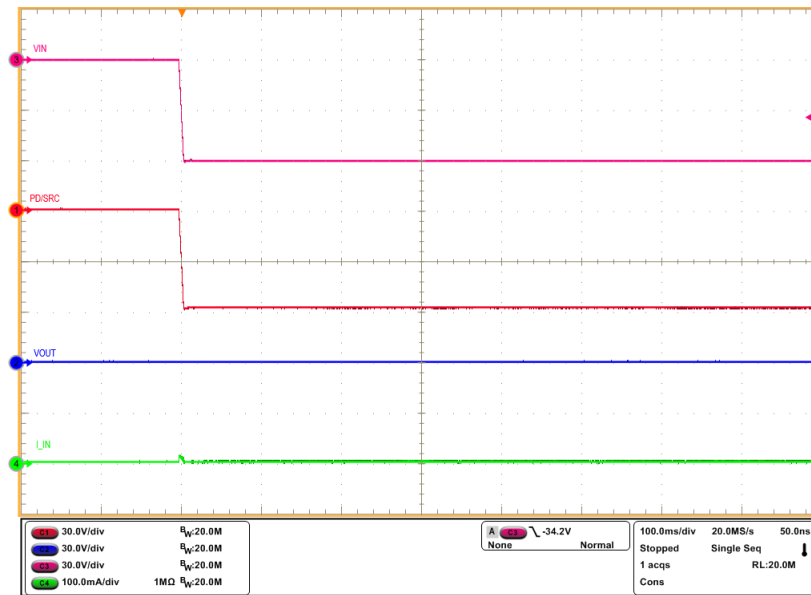

Figure 3-9. Input Reverse Polarity Protection of TPS48100-Q1 Device

4 Hardware Design Files

4.1 Schematic

Figure 4-1 illustrates the EVM schematic.

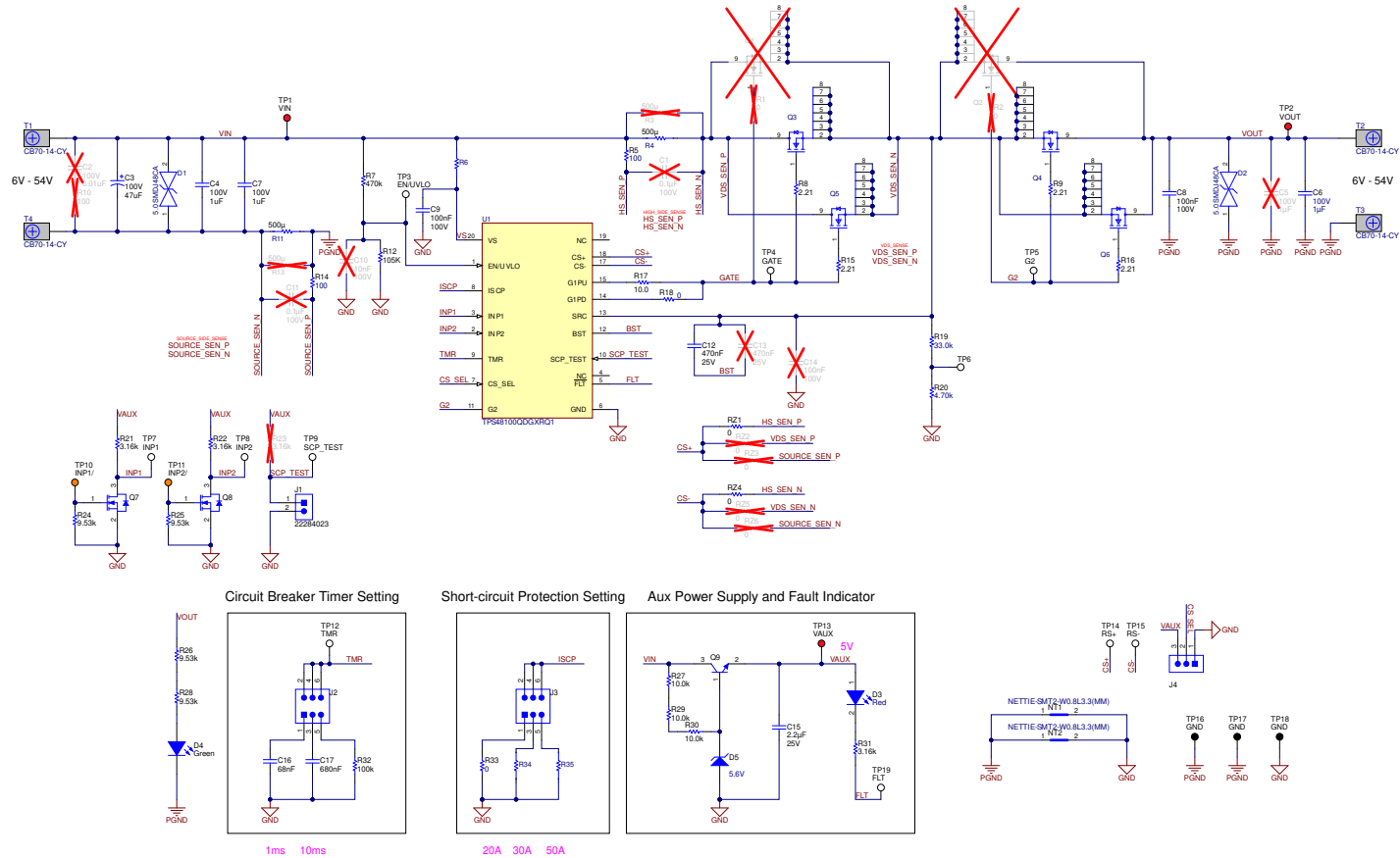

Figure 4-1. TPS4810Q1EVM: Evaluation Module Schematic

4.2 PCB Layout

Figure 4-2 shows component placement of the EVAL Board, and Figure 4-4 and Figure 4-6 show PCB layout images.

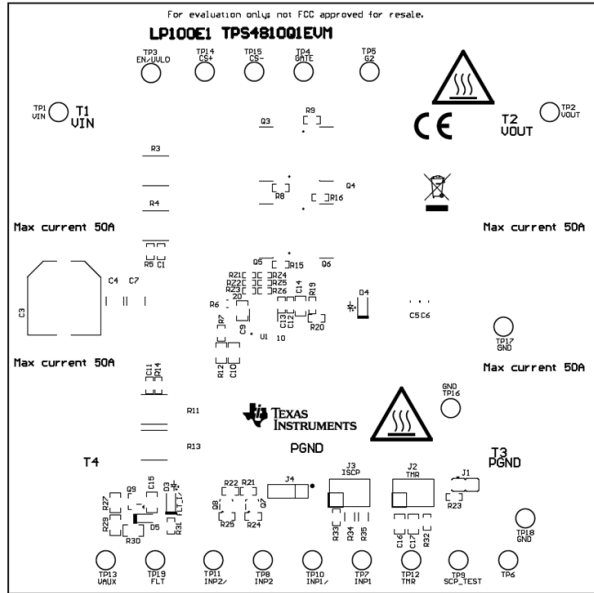

Figure 4-2. TPS4810Q1EVM Board Top Overlay

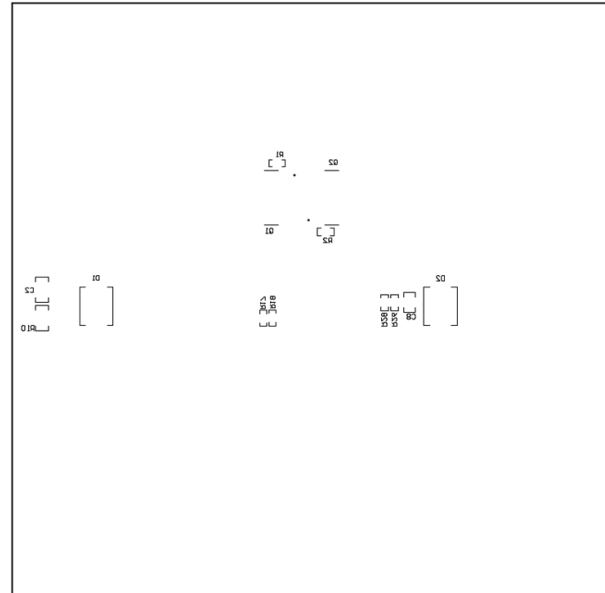

Figure 4-3. TPS4810Q1EVM Board Bottom Overlay

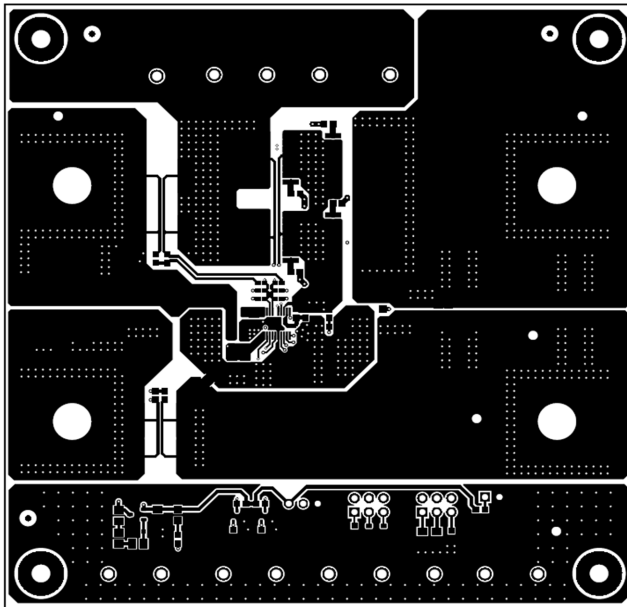

Figure 4-4. TPS4810Q1EVM Board Top Layer

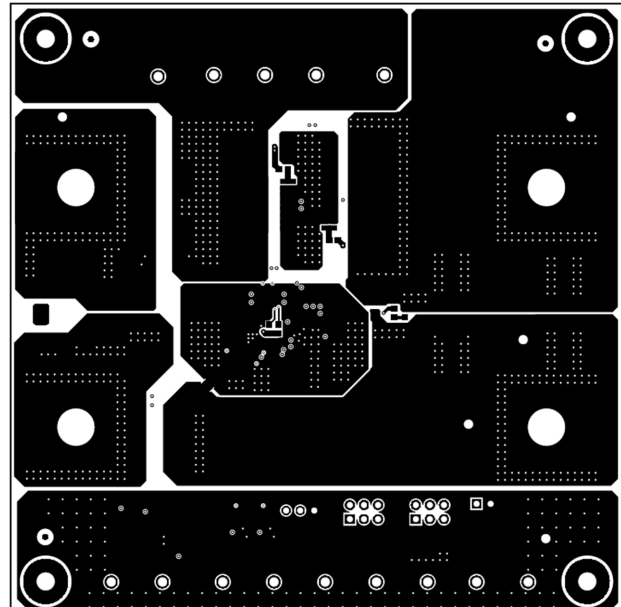

Figure 4-5. TPS4810Q1EVM Board Bottom Layer

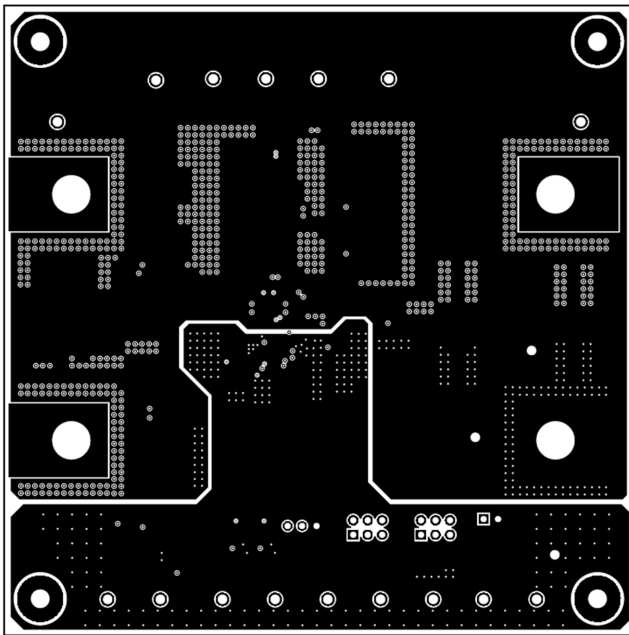

Figure 4-6. TPS4810Q1EVM Board Inner Signal Layer

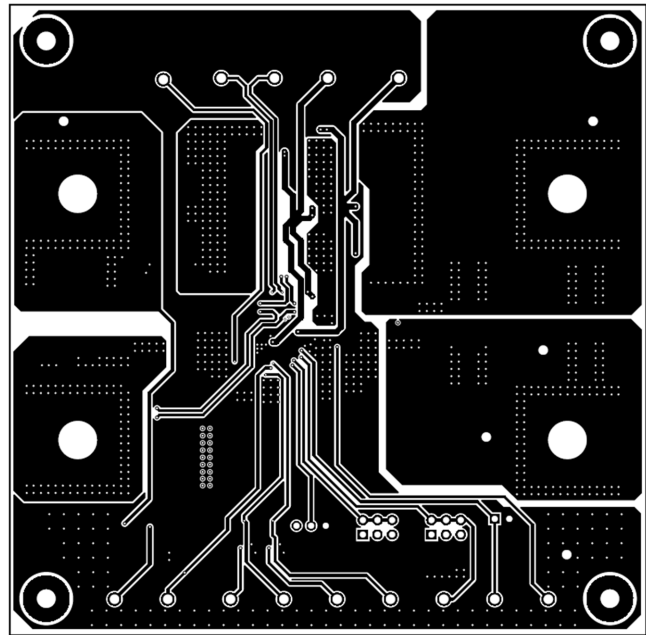

Figure 4-7. TPS4810Q1EVM Board Inner Routing Layer

4.3 Bill Of Materials (BoM)

Table 4-1 lists the EVM bill of materials.

Table 4-1. TPS4810Q1EVM Bill Of Materials

Designator	Quantity	Description	Part Number	Manufacturer
!PCB1	1	Printed Circuit Board	LP100	Any
C3	1	CAP, AL, 47 uF, 100 V, +/- 20%, 0.32 ohm, AEC-Q200 Grade 2, SMD	EEV-FK2A470Q	Panasonic
C4, C7	2	CAP, CERM, 1 uF, 100 V, +/- 10%, X7R, 1812	C4532X7R2A105K230KA	TDK
C6	1	CAP, CERM, 1 uF, 100 V, +/- 10%, X7R, AEC-Q200 Grade 1, 0805	08051C105K4Z2A	AVX
C8, C9	2	CAP, CERM, 0.1 uF, 100 V, +/- 10%, X7R, AEC-Q200 Grade 1, 0805	CGA4J2X7R2A104K125AA	TDK
C12	1	CAP, CERM, 0.47 uF, 25 V, +/- 10%, X7R, AEC-Q200 Grade 1, 0603	CGA3E3X7R1E474K080AB	TDK
C15	1	CAP, CERM, 2.2 uF, 25 V, +/- 10%, X7R, AEC-Q200 Grade 1, 0805	GCM21BR71E225KA73L	MuRata
C16	1	CAP, CERM, 0.068 uF, 100 V, +/- 10%, X7R, 0805	C0805C683K1RACTU	Kemet
C17	1	CAP, CERM, 0.68 uF, 50 V, +/- 10%, X7R, 0805	C0805C684K5RACTU	Kemet
D1, D2	2	TVS DIODE 48VWM 77.4VC DO214AB	5.0SMDJ48CA	Littelfuse Inc
D3	1	LED, Red, SMD	LTST-C170KRKT	Lite-On
D4	1	LED, Green, SMD	LTST-C170KGKT	Lite-On
D5	1	Diode, Zener, 5.6 V, 300 mW, AEC-Q101, SOD-323	SZMM3Z5V6ST1G	ON Semiconductor
H1, H2, H3, H4	4	Machine Screw, Round, #4-40 x 1/4, Nylon, Philips panhead	NY PMS 440 0025 PH	B&F Fastener Supply
H5, H6, H7, H8	4	Header	1902C	Keystone
J1	1	Header, 2.54mm, 2x1, Tin, TH	22284023	Molex
J2, J3	2	Header, 100mil, 3x2, Tin, TH	PEC03DAAN	Sullins Connector Solutions
J4	1	Header, 100mil, 3x1, Tin, TH	PEC03SAAN	Sullins Connector Solutions
Q3, Q4, Q5, Q6	4	N-Channel 80 V 300 A (Tc) 375W (Tc) Surface Mount PG-HSOG-8-1	IAUS300N08S5N012ATMA1	Infineon
Q7, Q8	2	MOSFET, N-CH, 60 V, 0.115 A, SOT-323	2N7002W-7-F	Diodes Inc.
Q9	1	Transistor, NPN, 160 V, 0.3 A, SOT-23	PMBT5551,215	Nexperia

Table 4-1. TPS4810Q1EVM Bill Of Materials (continued)

Designator	Quantity	Description	Part Number	Manufacturer
R4, R11	2	Res Metal Strip 3921 0.0005 Ohm 1% 3W ±175ppm/°C Molded SMD SMD Embossed Plastic T/R	WSL3921L5000FEA	Vishay Dale
R5, R14	2	RES, 100, 1%, 0.25 W, AEC-Q200 Grade 0, 0603	CRCW0603100RFKEAHP	Vishay Dale
R6	1	RES Thick Film, 100Ω, 1%, 0.5W, 100ppm/°C, 0805	CRCW0805100RFKEAHP	Vishay Dale
R7	1	RES, 470 k, 1%, 0.1 W, 0603	RC0603FR-07470KL	Yageo
R8, R9, R15, R16	4	RES, 2.21, 1%, 0.1 W, 0603	RC0603FR-072R21L	Yageo
R12	1	RES SMD 105K OHM 1% 1/8W 0805	CRCW0805105KFKEA	Vishay Dale
R17	1	RES, 10.0, 1%, 0.25 W, AEC-Q200 Grade 0, 0603	CRCW060310R0FKEAHP	Vishay Dale
R18, R33	2	RES, 0, 5%, 0.1 W, AEC-Q200 Grade 0, 0603	CRCW06030000Z0EA	Vishay Dale
R19	1	RES, 33.0 k, 1%, 0.1 W, 0603	RC0603FR-0733KL	Yageo
R20	1	RES, 4.70 k, 1%, 0.1 W, 0603	RC0603FR-074K7L	Yageo
R21, R22, R31	3	RES, 3.16 k, 1%, 0.1 W, AEC-Q200 Grade 0, 0603	CRCW06033K16FKEA	Vishay Dale
R24, R25, R26, R28	4	RES, 9.53 k, 1%, 0.1 W, 0603	RC0603FR-079K53L	Yageo
R27, R29, R30	3	RES, 10.0 k, 1%, 0.125 W, AEC-Q200 Grade 0, 0805	ERJ-6ENF1002V	Panasonic
R32	1	RES, 100 k, 1%, 0.1 W, AEC-Q200 Grade 0, 0603	CRCW0603100KFKEA	Vishay Dale
R34	1	RES Thick Film, 2.49kΩ, 1%, 0.33W, 100 ppm/°C, 0603	CRCW06032K49FKEAHP	Vishay Dale
R35	1	RES Thick Film, 7.5kΩ, 1%, 0.33W, 100 ppm/°C, 0603	CRCW06037K50FKEAHP	Vishay Dale
RZ1, RZ4	2	RES, 0, 5%, 0.063 W, AEC-Q200 Grade 0, 0402	CRCW04020000Z0ED	Vishay Dale
SH-J1, SH-J2, SH-J3, SH-J4	4	Shunt, 100mil, Flash Gold, Black	SPC02SYAN	Sullins Connector Solutions
T1, T2, T3, T4	4	Terminal 90 A Lug	CB70-14-CY	Panduit
TP1, TP2, TP13	3	Test Point, Multipurpose, Red, TH	5010	Keystone
TP3, TP4, TP5, TP6, TP7, TP8, TP9, TP12, TP14, TP15, TP19	11	Test Point, Multipurpose, White, TH	5012	Keystone
TP10, TP11	2	Test Point, Multipurpose, Orange, TH	5013	Keystone
TP16, TP17, TP18	3	Test Point, Multipurpose, Black, TH	5011	Keystone

Table 4-1. TPS4810Q1EVM Bill Of Materials (continued)

Designator	Quantity	Description	Part Number	Manufacturer
U1	1	Low IQ Smart High Side gate driver with SCP and Diagnostics	TPS48100QDQXRQ1	Texas Instruments
C1, C11	0	CAP, CERM, 0.1 μ F, 100 V, +/- 10%, X8L, AEC-Q200 Grade 0, 0603	GCJ188L8EL104KA07D	Murata
C2	0	CAP, CERM, 0.01 μ F, 100 V, +/- 10%, X7R, 1206	12061C103KAT2A	AVX
C5	0	CAP, CERM, 1 μ F, 100 V, +/- 10%, X7R, AEC-Q200 Grade 1, 0805	08051C105K4Z2A	AVX
C10	0	CAP, CERM, 0.01 μ F, 100 V, +/- 5%, X7R, 0805	08051C103JAT2A	AVX
C13	0	CAP, CERM, 0.47 μ F, 25 V, +/- 10%, X7R, AEC-Q200 Grade 1, 0603	CGA3E3X7R1E474K080AB	TDK
C14	0	CAP, CERM, 0.1 μ F, 100 V, +/- 10%, X7R, AEC-Q200 Grade 1, 0805	CGA4J2X7R2A104K125AA	TDK
FID1, FID2, FID3, FID4, FID5, FID6	0	Fiducial mark. There is nothing to buy or mount.	N/A	N/A
Q1, Q2	0	N-Channel 80 V 300 A (Tc) 375W (Tc) Surface Mount PG-HSOG-8-1	IAUS300N08S5N012ATMA1	Infineon
R1, R2	0	RES, 0, 5%, 0.1 W, AEC-Q200 Grade 0, 0603	CRCW06030000Z0EA	Vishay-Dale
R3, R13	0	Res Metal Strip 3921 0.0005 Ohm 1% 3W \pm 175ppm/ $^{\circ}$ C Molded SMD SMD Embossed Plastic T/R	WSL3921L5000FEA	Vishay-Dale
R10	0	RES, 100, 1%, 0.5 W, AEC-Q200 Grade 0, 1206	CRCW1206100RFKEAHP	Vishay-Dale
R23	0	RES, 3.16 k, 1%, 0.1 W, AEC-Q200 Grade 0, 0603	CRCW06033K16FKEA	Vishay-Dale
RZ2, RZ3, RZ5, RZ6	0	RES, 0, 5%, 0.063 W, AEC-Q200 Grade 0, 0402	CRCW04020000Z0ED	Vishay-Dale

5 Additional Information

Trademarks

All trademarks are the property of their respective owners.

STANDARD TERMS FOR EVALUATION MODULES

1. *Delivery:* TI delivers TI evaluation boards, kits, or modules, including any accompanying demonstration software, components, and/or documentation which may be provided together or separately (collectively, an "EVM" or "EVMs") to the User ("User") in accordance with the terms set forth herein. User's acceptance of the EVM is expressly subject to the following terms.
 - 1.1 EVMs are intended solely for product or software developers for use in a research and development setting to facilitate feasibility evaluation, experimentation, or scientific analysis of TI semiconductor products. EVMs have no direct function and are not finished products. EVMs shall not be directly or indirectly assembled as a part or subassembly in any finished product. For clarification, any software or software tools provided with the EVM ("Software") shall not be subject to the terms and conditions set forth herein but rather shall be subject to the applicable terms that accompany such Software
 - 1.2 EVMs are not intended for consumer or household use. EVMs may not be sold, sublicensed, leased, rented, loaned, assigned, or otherwise distributed for commercial purposes by Users, in whole or in part, or used in any finished product or production system.
2. *Limited Warranty and Related Remedies/Disclaimers:*
 - 2.1 These terms do not apply to Software. The warranty, if any, for Software is covered in the applicable Software License Agreement.
 - 2.2 TI warrants that the TI EVM will conform to TI's published specifications for ninety (90) days after the date TI delivers such EVM to User. Notwithstanding the foregoing, TI shall not be liable for a nonconforming EVM if (a) the nonconformity was caused by neglect, misuse or mistreatment by an entity other than TI, including improper installation or testing, or for any EVMs that have been altered or modified in any way by an entity other than TI, (b) the nonconformity resulted from User's design, specifications or instructions for such EVMs or improper system design, or (c) User has not paid on time. Testing and other quality control techniques are used to the extent TI deems necessary. TI does not test all parameters of each EVM. User's claims against TI under this Section 2 are void if User fails to notify TI of any apparent defects in the EVMs within ten (10) business days after delivery, or of any hidden defects with ten (10) business days after the defect has been detected.
 - 2.3 TI's sole liability shall be at its option to repair or replace EVMs that fail to conform to the warranty set forth above, or credit User's account for such EVM. TI's liability under this warranty shall be limited to EVMs that are returned during the warranty period to the address designated by TI and that are determined by TI not to conform to such warranty. If TI elects to repair or replace such EVM, TI shall have a reasonable time to repair such EVM or provide replacements. Repaired EVMs shall be warranted for the remainder of the original warranty period. Replaced EVMs shall be warranted for a new full ninety (90) day warranty period.

WARNING

Evaluation Kits are intended solely for use by technically qualified, professional electronics experts who are familiar with the dangers and application risks associated with handling electrical mechanical components, systems, and subsystems.

User shall operate the Evaluation Kit within TI's recommended guidelines and any applicable legal or environmental requirements as well as reasonable and customary safeguards. Failure to set up and/or operate the Evaluation Kit within TI's recommended guidelines may result in personal injury or death or property damage. Proper set up entails following TI's instructions for electrical ratings of interface circuits such as input, output and electrical loads.

NOTE:

EXPOSURE TO ELECTROSTATIC DISCHARGE (ESD) MAY CAUSE DEGRADATION OR FAILURE OF THE EVALUATION KIT; TI RECOMMENDS STORAGE OF THE EVALUATION KIT IN A PROTECTIVE ESD BAG.

3 Regulatory Notices:

3.1 United States

3.1.1 Notice applicable to EVMs not FCC-Approved:

FCC NOTICE: This kit is designed to allow product developers to evaluate electronic components, circuitry, or software associated with the kit to determine whether to incorporate such items in a finished product and software developers to write software applications for use with the end product. This kit is not a finished product and when assembled may not be resold or otherwise marketed unless all required FCC equipment authorizations are first obtained. Operation is subject to the condition that this product not cause harmful interference to licensed radio stations and that this product accept harmful interference. Unless the assembled kit is designed to operate under part 15, part 18 or part 95 of this chapter, the operator of the kit must operate under the authority of an FCC license holder or must secure an experimental authorization under part 5 of this chapter.

3.1.2 For EVMs annotated as FCC – FEDERAL COMMUNICATIONS COMMISSION Part 15 Compliant:

CAUTION

This device complies with part 15 of the FCC Rules. Operation is subject to the following two conditions: (1) This device may not cause harmful interference, and (2) this device must accept any interference received, including interference that may cause undesired operation.

Changes or modifications not expressly approved by the party responsible for compliance could void the user's authority to operate the equipment.

FCC Interference Statement for Class A EVM devices

NOTE: This equipment has been tested and found to comply with the limits for a Class A digital device, pursuant to part 15 of the FCC Rules. These limits are designed to provide reasonable protection against harmful interference when the equipment is operated in a commercial environment. This equipment generates, uses, and can radiate radio frequency energy and, if not installed and used in accordance with the instruction manual, may cause harmful interference to radio communications. Operation of this equipment in a residential area is likely to cause harmful interference in which case the user will be required to correct the interference at his own expense.

FCC Interference Statement for Class B EVM devices

NOTE: This equipment has been tested and found to comply with the limits for a Class B digital device, pursuant to part 15 of the FCC Rules. These limits are designed to provide reasonable protection against harmful interference in a residential installation. This equipment generates, uses and can radiate radio frequency energy and, if not installed and used in accordance with the instructions, may cause harmful interference to radio communications. However, there is no guarantee that interference will not occur in a particular installation. If this equipment does cause harmful interference to radio or television reception, which can be determined by turning the equipment off and on, the user is encouraged to try to correct the interference by one or more of the following measures:

- Reorient or relocate the receiving antenna.
- Increase the separation between the equipment and receiver.
- Connect the equipment into an outlet on a circuit different from that to which the receiver is connected.
- Consult the dealer or an experienced radio/TV technician for help.

3.2 Canada

3.2.1 For EVMs issued with an Industry Canada Certificate of Conformance to RSS-210 or RSS-247

Concerning EVMs Including Radio Transmitters:

This device complies with Industry Canada license-exempt RSSs. Operation is subject to the following two conditions:

(1) this device may not cause interference, and (2) this device must accept any interference, including interference that may cause undesired operation of the device.

Concernant les EVMs avec appareils radio:

Le présent appareil est conforme aux CNR d'Industrie Canada applicables aux appareils radio exempts de licence. L'exploitation est autorisée aux deux conditions suivantes: (1) l'appareil ne doit pas produire de brouillage, et (2) l'utilisateur de l'appareil doit accepter tout brouillage radioélectrique subi, même si le brouillage est susceptible d'en compromettre le fonctionnement.

Concerning EVMs Including Detachable Antennas:

Under Industry Canada regulations, this radio transmitter may only operate using an antenna of a type and maximum (or lesser) gain approved for the transmitter by Industry Canada. To reduce potential radio interference to other users, the antenna type and its gain should be so chosen that the equivalent isotropically radiated power (e.i.r.p.) is not more than that necessary for successful communication. This radio transmitter has been approved by Industry Canada to operate with the antenna types listed in the user guide with the maximum permissible gain and required antenna impedance for each antenna type indicated. Antenna types not included in this list, having a gain greater than the maximum gain indicated for that type, are strictly prohibited for use with this device.

Concernant les EVMs avec antennes détachables

Conformément à la réglementation d'Industrie Canada, le présent émetteur radio peut fonctionner avec une antenne d'un type et d'un gain maximal (ou inférieur) approuvé pour l'émetteur par Industrie Canada. Dans le but de réduire les risques de brouillage radioélectrique à l'intention des autres utilisateurs, il faut choisir le type d'antenne et son gain de sorte que la puissance isotrope rayonnée équivalente (p.i.r.e.) ne dépasse pas l'intensité nécessaire à l'établissement d'une communication satisfaisante. Le présent émetteur radio a été approuvé par Industrie Canada pour fonctionner avec les types d'antenne énumérés dans le manuel d'usage et ayant un gain admissible maximal et l'impédance requise pour chaque type d'antenne. Les types d'antenne non inclus dans cette liste, ou dont le gain est supérieur au gain maximal indiqué, sont strictement interdits pour l'exploitation de l'émetteur.

3.3 Japan

3.3.1 *Notice for EVMs delivered in Japan:* Please see http://www.tij.co.jp/lstds/ti_ja/general/eStore/notice_01.page 日本国内に輸入される評価用キット、ボードについては、次のところをご覧ください。

<https://www.ti.com/ja-jp/legal/notice-for-evaluation-kits-delivered-in-japan.html>

3.3.2 *Notice for Users of EVMs Considered "Radio Frequency Products" in Japan:* EVMs entering Japan may not be certified by TI as conforming to Technical Regulations of Radio Law of Japan.

If User uses EVMs in Japan, not certified to Technical Regulations of Radio Law of Japan, User is required to follow the instructions set forth by Radio Law of Japan, which includes, but is not limited to, the instructions below with respect to EVMs (which for the avoidance of doubt are stated strictly for convenience and should be verified by User):

1. Use EVMs in a shielded room or any other test facility as defined in the notification #173 issued by Ministry of Internal Affairs and Communications on March 28, 2006, based on Sub-section 1.1 of Article 6 of the Ministry's Rule for Enforcement of Radio Law of Japan,
2. Use EVMs only after User obtains the license of Test Radio Station as provided in Radio Law of Japan with respect to EVMs, or
3. Use of EVMs only after User obtains the Technical Regulations Conformity Certification as provided in Radio Law of Japan with respect to EVMs. Also, do not transfer EVMs, unless User gives the same notice above to the transferee. Please note that if User does not follow the instructions above, User will be subject to penalties of Radio Law of Japan.

【無線電波を送信する製品の開発キットをお使いになる際の注意事項】 開発キットの中には技術基準適合証明を受けていないものがあります。技術適合証明を受けていないものご使用に際しては、電波法遵守のため、以下のいずれかの措置を取っていただく必要がありますのでご注意ください。

1. 電波法施行規則第6条第1項第1号に基づく平成18年3月28日総務省告示第173号で定められた電波暗室等の試験設備でご使用いただく。
2. 実験局の免許を取得後ご使用いただく。
3. 技術基準適合証明を取得後ご使用いただく。

なお、本製品は、上記の「ご使用にあたっての注意」を譲渡先、移転先に通知しない限り、譲渡、移転できないものとします。

上記を遵守頂けない場合は、電波法の罰則が適用される可能性があることをご留意ください。日本テキサス・イ

ンスツルメンツ株式会社

東京都新宿区西新宿 6 丁目 2 4 番 1 号

西新宿三井ビル

3.3.3 *Notice for EVMs for Power Line Communication:* Please see http://www.tij.co.jp/lstds/ti_ja/general/eStore/notice_02.page

電力線搬送波通信についての開発キットをお使いになる際の注意事項については、次のところをご覧ください。 <https://www.ti.com/ja-jp/legal/notice-for-evaluation-kits-for-power-line-communication.html>

3.4 European Union

3.4.1 *For EVMs subject to EU Directive 2014/30/EU (Electromagnetic Compatibility Directive):*

This is a class A product intended for use in environments other than domestic environments that are connected to a low-voltage power-supply network that supplies buildings used for domestic purposes. In a domestic environment this product may cause radio interference in which case the user may be required to take adequate measures.

-
- 4 *EVM Use Restrictions and Warnings:*
- 4.1 EVMS ARE NOT FOR USE IN FUNCTIONAL SAFETY AND/OR SAFETY CRITICAL EVALUATIONS, INCLUDING BUT NOT LIMITED TO EVALUATIONS OF LIFE SUPPORT APPLICATIONS.
- 4.2 User must read and apply the user guide and other available documentation provided by TI regarding the EVM prior to handling or using the EVM, including without limitation any warning or restriction notices. The notices contain important safety information related to, for example, temperatures and voltages.
- 4.3 *Safety-Related Warnings and Restrictions:*
- 4.3.1 User shall operate the EVM within TI's recommended specifications and environmental considerations stated in the user guide, other available documentation provided by TI, and any other applicable requirements and employ reasonable and customary safeguards. Exceeding the specified performance ratings and specifications (including but not limited to input and output voltage, current, power, and environmental ranges) for the EVM may cause personal injury or death, or property damage. If there are questions concerning performance ratings and specifications, User should contact a TI field representative prior to connecting interface electronics including input power and intended loads. Any loads applied outside of the specified output range may also result in unintended and/or inaccurate operation and/or possible permanent damage to the EVM and/or interface electronics. Please consult the EVM user guide prior to connecting any load to the EVM output. If there is uncertainty as to the load specification, please contact a TI field representative. During normal operation, even with the inputs and outputs kept within the specified allowable ranges, some circuit components may have elevated case temperatures. These components include but are not limited to linear regulators, switching transistors, pass transistors, current sense resistors, and heat sinks, which can be identified using the information in the associated documentation. When working with the EVM, please be aware that the EVM may become very warm.
- 4.3.2 EVMs are intended solely for use by technically qualified, professional electronics experts who are familiar with the dangers and application risks associated with handling electrical mechanical components, systems, and subsystems. User assumes all responsibility and liability for proper and safe handling and use of the EVM by User or its employees, affiliates, contractors or designees. User assumes all responsibility and liability to ensure that any interfaces (electronic and/or mechanical) between the EVM and any human body are designed with suitable isolation and means to safely limit accessible leakage currents to minimize the risk of electrical shock hazard. User assumes all responsibility and liability for any improper or unsafe handling or use of the EVM by User or its employees, affiliates, contractors or designees.
- 4.4 User assumes all responsibility and liability to determine whether the EVM is subject to any applicable international, federal, state, or local laws and regulations related to User's handling and use of the EVM and, if applicable, User assumes all responsibility and liability for compliance in all respects with such laws and regulations. User assumes all responsibility and liability for proper disposal and recycling of the EVM consistent with all applicable international, federal, state, and local requirements.
5. *Accuracy of Information:* To the extent TI provides information on the availability and function of EVMs, TI attempts to be as accurate as possible. However, TI does not warrant the accuracy of EVM descriptions, EVM availability or other information on its websites as accurate, complete, reliable, current, or error-free.
6. *Disclaimers:*
- 6.1 EXCEPT AS SET FORTH ABOVE, EVMS AND ANY MATERIALS PROVIDED WITH THE EVM (INCLUDING, BUT NOT LIMITED TO, REFERENCE DESIGNS AND THE DESIGN OF THE EVM ITSELF) ARE PROVIDED "AS IS" AND "WITH ALL FAULTS." TI DISCLAIMS ALL OTHER WARRANTIES, EXPRESS OR IMPLIED, REGARDING SUCH ITEMS, INCLUDING BUT NOT LIMITED TO ANY EPIDEMIC FAILURE WARRANTY OR IMPLIED WARRANTIES OF MERCHANTABILITY OR FITNESS FOR A PARTICULAR PURPOSE OR NON-INFRINGEMENT OF ANY THIRD PARTY PATENTS, COPYRIGHTS, TRADE SECRETS OR OTHER INTELLECTUAL PROPERTY RIGHTS.
- 6.2 EXCEPT FOR THE LIMITED RIGHT TO USE THE EVM SET FORTH HEREIN, NOTHING IN THESE TERMS SHALL BE CONSTRUED AS GRANTING OR CONFERRING ANY RIGHTS BY LICENSE, PATENT, OR ANY OTHER INDUSTRIAL OR INTELLECTUAL PROPERTY RIGHT OF TI, ITS SUPPLIERS/LICENSORS OR ANY OTHER THIRD PARTY, TO USE THE EVM IN ANY FINISHED END-USER OR READY-TO-USE FINAL PRODUCT, OR FOR ANY INVENTION, DISCOVERY OR IMPROVEMENT, REGARDLESS OF WHEN MADE, CONCEIVED OR ACQUIRED.
7. *USER'S INDEMNITY OBLIGATIONS AND REPRESENTATIONS.* USER WILL DEFEND, INDEMNIFY AND HOLD TI, ITS LICENSORS AND THEIR REPRESENTATIVES HARMLESS FROM AND AGAINST ANY AND ALL CLAIMS, DAMAGES, LOSSES, EXPENSES, COSTS AND LIABILITIES (COLLECTIVELY, "CLAIMS") ARISING OUT OF OR IN CONNECTION WITH ANY HANDLING OR USE OF THE EVM THAT IS NOT IN ACCORDANCE WITH THESE TERMS. THIS OBLIGATION SHALL APPLY WHETHER CLAIMS ARISE UNDER STATUTE, REGULATION, OR THE LAW OF TORT, CONTRACT OR ANY OTHER LEGAL THEORY, AND EVEN IF THE EVM FAILS TO PERFORM AS DESCRIBED OR EXPECTED.

8. *Limitations on Damages and Liability:*

8.1 *General Limitations.* IN NO EVENT SHALL TI BE LIABLE FOR ANY SPECIAL, COLLATERAL, INDIRECT, PUNITIVE, INCIDENTAL, CONSEQUENTIAL, OR EXEMPLARY DAMAGES IN CONNECTION WITH OR ARISING OUT OF THESE TERMS OR THE USE OF THE EVMS , REGARDLESS OF WHETHER TI HAS BEEN ADVISED OF THE POSSIBILITY OF SUCH DAMAGES. EXCLUDED DAMAGES INCLUDE, BUT ARE NOT LIMITED TO, COST OF REMOVAL OR REINSTALLATION, ANCILLARY COSTS TO THE PROCUREMENT OF SUBSTITUTE GOODS OR SERVICES, RETESTING, OUTSIDE COMPUTER TIME, LABOR COSTS, LOSS OF GOODWILL, LOSS OF PROFITS, LOSS OF SAVINGS, LOSS OF USE, LOSS OF DATA, OR BUSINESS INTERRUPTION. NO CLAIM, SUIT OR ACTION SHALL BE BROUGHT AGAINST TI MORE THAN TWELVE (12) MONTHS AFTER THE EVENT THAT GAVE RISE TO THE CAUSE OF ACTION HAS OCCURRED.

8.2 *Specific Limitations.* IN NO EVENT SHALL TI'S AGGREGATE LIABILITY FROM ANY USE OF AN EVM PROVIDED HEREUNDER, INCLUDING FROM ANY WARRANTY, INDEMNITY OR OTHER OBLIGATION ARISING OUT OF OR IN CONNECTION WITH THESE TERMS, , EXCEED THE TOTAL AMOUNT PAID TO TI BY USER FOR THE PARTICULAR EVM(S) AT ISSUE DURING THE PRIOR TWELVE (12) MONTHS WITH RESPECT TO WHICH LOSSES OR DAMAGES ARE CLAIMED. THE EXISTENCE OF MORE THAN ONE CLAIM SHALL NOT ENLARGE OR EXTEND THIS LIMIT.

9. *Return Policy.* Except as otherwise provided, TI does not offer any refunds, returns, or exchanges. Furthermore, no return of EVM(s) will be accepted if the package has been opened and no return of the EVM(s) will be accepted if they are damaged or otherwise not in a resalable condition. If User feels it has been incorrectly charged for the EVM(s) it ordered or that delivery violates the applicable order, User should contact TI. All refunds will be made in full within thirty (30) working days from the return of the components(s), excluding any postage or packaging costs.

10. *Governing Law:* These terms and conditions shall be governed by and interpreted in accordance with the laws of the State of Texas, without reference to conflict-of-laws principles. User agrees that non-exclusive jurisdiction for any dispute arising out of or relating to these terms and conditions lies within courts located in the State of Texas and consents to venue in Dallas County, Texas. Notwithstanding the foregoing, any judgment may be enforced in any United States or foreign court, and TI may seek injunctive relief in any United States or foreign court.

Mailing Address: Texas Instruments, Post Office Box 655303, Dallas, Texas 75265
Copyright © 2023, Texas Instruments Incorporated

IMPORTANT NOTICE AND DISCLAIMER

TI PROVIDES TECHNICAL AND RELIABILITY DATA (INCLUDING DATA SHEETS), DESIGN RESOURCES (INCLUDING REFERENCE DESIGNS), APPLICATION OR OTHER DESIGN ADVICE, WEB TOOLS, SAFETY INFORMATION, AND OTHER RESOURCES "AS IS" AND WITH ALL FAULTS, AND DISCLAIMS ALL WARRANTIES, EXPRESS AND IMPLIED, INCLUDING WITHOUT LIMITATION ANY IMPLIED WARRANTIES OF MERCHANTABILITY, FITNESS FOR A PARTICULAR PURPOSE OR NON-INFRINGEMENT OF THIRD PARTY INTELLECTUAL PROPERTY RIGHTS.

These resources are intended for skilled developers designing with TI products. You are solely responsible for (1) selecting the appropriate TI products for your application, (2) designing, validating and testing your application, and (3) ensuring your application meets applicable standards, and any other safety, security, regulatory or other requirements.

These resources are subject to change without notice. TI grants you permission to use these resources only for development of an application that uses the TI products described in the resource. Other reproduction and display of these resources is prohibited. No license is granted to any other TI intellectual property right or to any third party intellectual property right. TI disclaims responsibility for, and you will fully indemnify TI and its representatives against, any claims, damages, costs, losses, and liabilities arising out of your use of these resources.

TI's products are provided subject to [TI's Terms of Sale](#) or other applicable terms available either on [ti.com](https://www.ti.com) or provided in conjunction with such TI products. TI's provision of these resources does not expand or otherwise alter TI's applicable warranties or warranty disclaimers for TI products.

TI objects to and rejects any additional or different terms you may have proposed.

Mailing Address: Texas Instruments, Post Office Box 655303, Dallas, Texas 75265
Copyright © 2023, Texas Instruments Incorporated