

Design Guide: TIDA-050044

M.2 フォーム・ファクタ SSD 向け小型高効率電源のリファレンス・デザイン



概要

この小型で効率的な電源のリファレンス・デザインは、M.2 フォーム・ファクタのクライアント SSD (ソリッド・ステート・ドライブ) 向けの電源ソリューションを提示します。このソリューションは、3 個の DC/DC コンバータと 1 個のリニア・レギュレータを使用しています。さらに、出力のうち 1 つは、I²C 通信経路で出力電圧を変更するフレキシビリティに対応しています。

リソース

[TIDA-050044](#)

デザイン・フォルダ

[TPS62864](#)

プロダクト・フォルダ

[TPS62088](#)

プロダクト・フォルダ

TLV733P

プロダクト・フォルダ

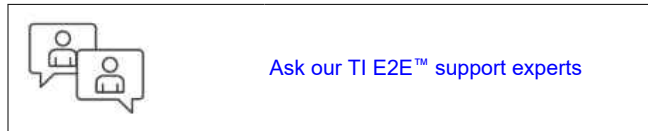

特長

- 3.3V の入力電圧
- 40.8mm² の面積
- 高効率
- 軽負荷時の効率に寄与する自動パワー・セーブ・モード
- I²C により出力電圧を調整可能

アプリケーション

- ソリッドステート・ドライブ (SSD)

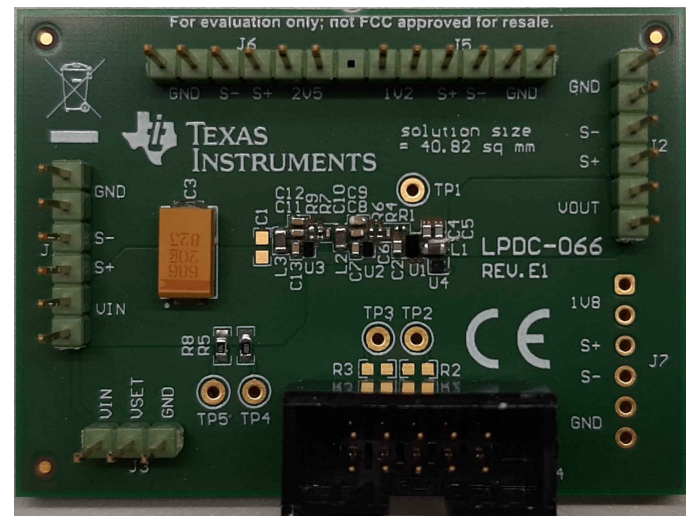
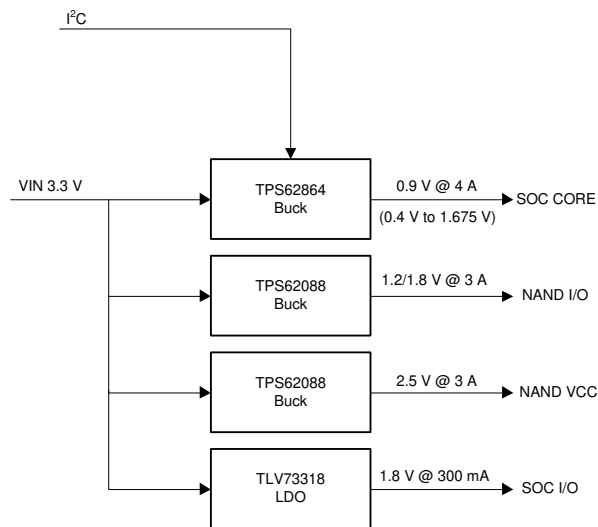

1 System Description

The TIDA-050044 optimizes the TPS62864 DC/DC converter, the TPS62088 DC/DC converter and the TLV73318 LDO to produce a small, efficient power solution for M.2 form factor. This power solution supply 2.5-V, 1.8-V, 1.2-V and 0.9-V rails from a 3.3 V rail. The DC/DC converters can operate in power save mode for maximum efficiency at light loads.

Both the TPS62864 and TPS62088 come in ultra-small wafer-chip-scale packages (WCSP) for smallest solution size, and switch at high frequencies, 2.4 MHz and 4MHz respectively, which decreases the size of output filter.

External components have been optimized also optimized to produce a small solution size. The TLV73318 capacitor-free LDO comes in a 1 sq mm package and does not require external component to operate.

1.1 Key System Specifications

表 1-1. Key System Specifications

PARAMETERS		CONDITIONS	MIN	TYP	MAX	UNIT
Input voltage range			2.7	3.3	5.5	V
OUTPUTS PROVIDED						
TPS62864 0V9 SOC_CORE	Output voltage	VIN = 3.3 V	0.4	0.9	1.675	V
	Output current				4	A
TP62088 1V2 NAND_IO	Output voltage	VIN = 3.3 V	0.6	1.2	3.1	V
	Output current				3	A
TPS62088 2V5 NAND_VCC	Output voltage	VIN = 3.3 V	0.6	2.5	3.1	V
	Output current				3	A
TLV73318 1V8 SOC_IO	Output voltage	VIN = 3.3 V		1.8		A
	Output current				300	mA

2 System Overview

2.1 ブロック図



図 2-1. TIDA-050044 のブロック図

2.2 Design Considerations

The design uses the adjustable output voltage version of TPS62088 which sets the output voltage of U2 and U3 depending of the value of the resistors R4, R6 and R7, R9 respectively.

The supply of the NAND IO is usually 1.2 V or 1.8 V. By default, U2 is set to output 1.2 V. However, it is also possible to use the IC fixed versions TPS6208812 or TPS6208818 to obtain 1.2 V or 1.8 V respectively. In that case, R4, R6 and C6 should be removed and the FB pin should be connected to the output. The difference in the design is shown in 図 2-2 and 図 2-3.

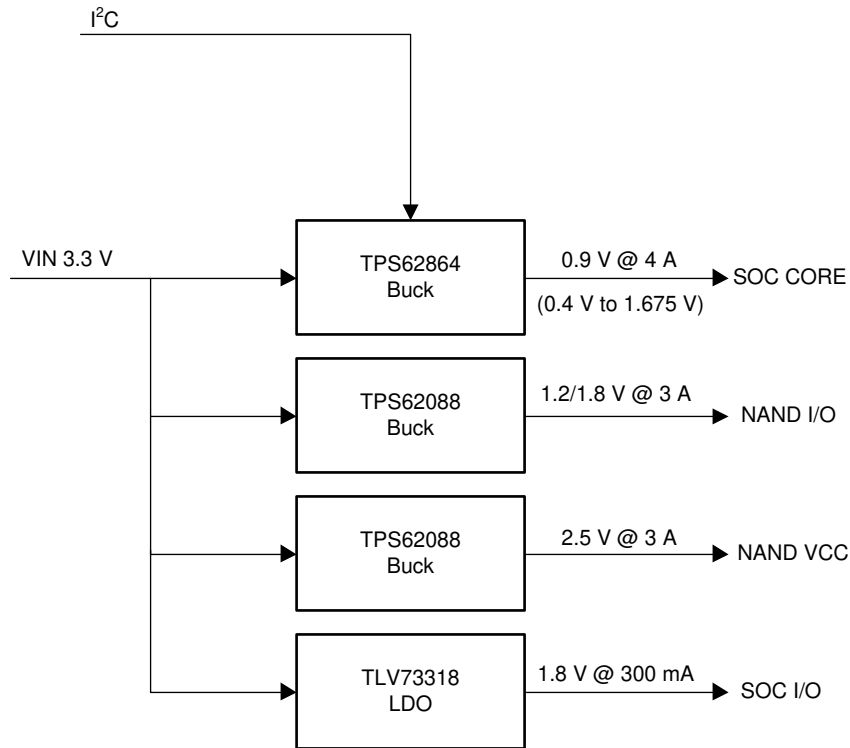

図 2-2. Typical Reference Design of Adjustable Output



図 2-3. Typical Reference Design of Fixed Output

2.3 Highlighted Products

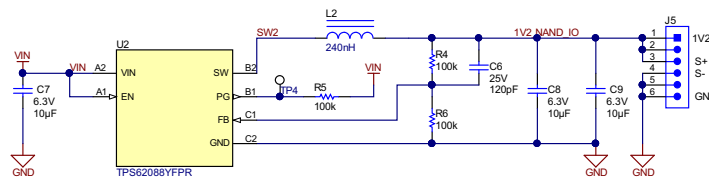
2.3.1 TPS62864

The TPS62864 device is a high-frequency synchronous step-down converter with I²C interface which provide a high power density solution. At medium to heavy loads, the converter operates in PWM mode and automatically enters Power Save Mode operation at light load to maintain high efficiency over the entire load current range. The device can also be forced in PWM mode operation for small output voltage ripples. Together with its DCS-control architecture, excellent load transient performance and tight output voltage accuracy are achieved. The devices are available in a 15-pin WCSP package.

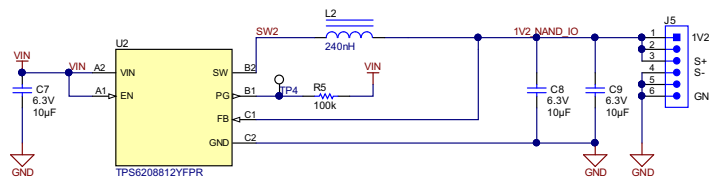
2.3.2 TPS62088

The TPS62088 device is a high-frequency synchronous step-down converter optimized for small solution size and high efficiency. At medium to heavy loads, the converter operates in PWM mode and automatically enters Power Save Mode operation at light load to maintain high efficiency over the entire load current range. The 4-MHz switching frequency allows TPS62088 to use small external components. Together with its DCS-control architecture, excellent load transient performance and output voltage regulation accuracy are achieved. Other features like over current protection, thermal shutdown protection, active output discharge and power good are built-in. The device is available in a 6-pin WCSP package.

This device offers three variations that have fixed output voltage as shown in [表 2-1](#). In this reference design, the adjustable version is used but it can be scaled to use a fixed voltage version.

表 2-1. Device Comparison Table

PART NUMBER	OUTPUT VOLTAGE
TPS62088YFP	Adjustable
TPS6208812YFP	1.2 V
TPS6208818YFP	1.8 V
TPS6208833YFP	3.3 V

2.3.3 TLV73318

The TLV733P family of low dropout (LDO) linear regulators are ultra-small, low quiescent current LDOs that can source 300 mA with good line and load transient performance. These devices provide a typical accuracy of 1%.

The TLV733P family is designed with a modern capacitor-free architecture to ensure stability without an input or output capacitor. The removal of the output capacitor allows for a very small solution size, and can eliminate inrush current at startup.

In addition, the TLV733P family is also stable with ceramic output capacitors if an output capacitor is necessary. The TLV733P family also provides foldback current control during device power-up and enabling if an output capacitor is used. This functionality is especially important in battery operated devices.

The TLV733P family provides an active pulldown circuit to quickly discharge output loads when disabled.

In this reference design, the TLV73318 uses the 4-pin DQN (X2SON) package and the 1.8 V voltage output version.

2.4 System Design Theory

2.4.1 Designing Buck Converter Circuit TPS62864



図 2-4. Designing Buck Converter Circuit TPS62864

To support a simple evaluation, a tantalum input capacitor C3 is used to ensure a steady, low-impedance supply voltage for the ICs.

Also, to achieve a smaller package size, the GRM155R60J226ME11 22uF 0402 capacitors were used in C2, C4, and C5. The recommended minimum input capacitance for this device is 8uF. According to the characteristics of this capacitor, this would mean that the maximum input voltage should be 3.3 V to ensure that C2 effective capacitance is 8uF. Similar considerations were applied for the TPS62088 designs.

2.4.2 Designing Buck Converter Circuit TPS62088

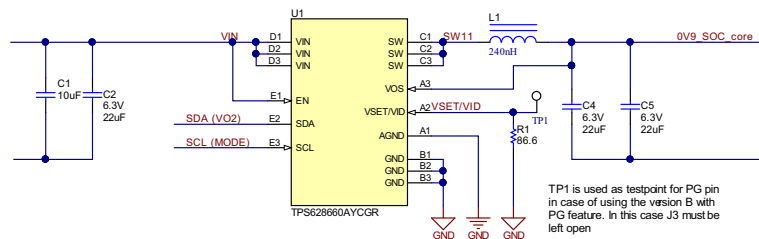

図 2-5. Designing Buck Converter Circuit TPS62088 - 2.5 V Voltage Rail



図 2-6. Designing Buck Converter Circuit TPS62088 - 1.2V Voltage Rail

2.4.3 Designing Buck Converter Circuit TLV73318

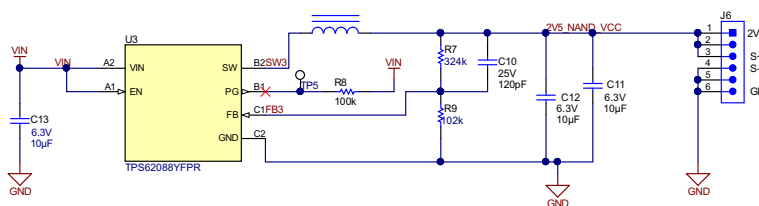

図 2-7. Designing Buck Converter Circuit TLV73318

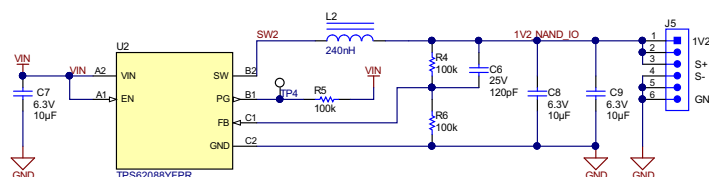
3 Hardware, Software, Testing Requirements, and Test Results

3.1 Testing and Results

3.1.1 Test Setup

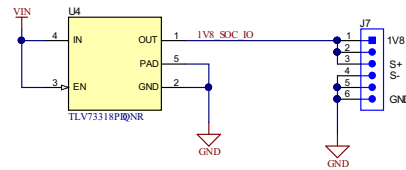
Load Transient measurements were performed in the four DC/DC converters using typical values for an SSD application. Every module was measured while the other modules had a constant load with the following operating values:

- SoC 0.9 V – 2.0 A
- NAND I/O 1.2 V – 1.3 A
- NAND VCC 2.5 V – 1.7 A
- SOC I/O 1.8 V – 10mA

3.1.2 Test Results

3.1.2.1 Startup with no load

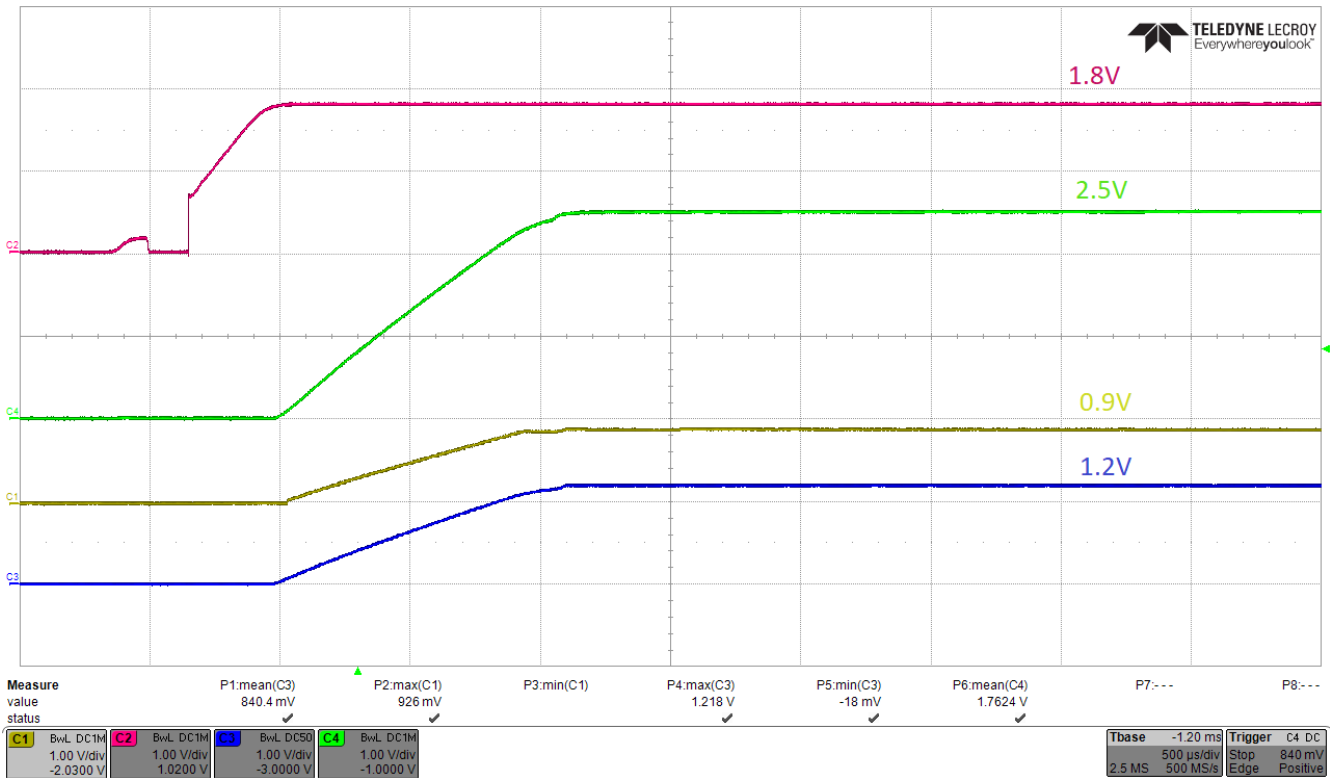

3-1. Startup with no Load

3.1.2.2 Load Transient Rail SoC 0.9V



図 3-2. Vin = 3.3 V, Vout = 0.9 V, ILoad 5mA to 2A and Vpp ~ ±35mV

3.1.2.3 Load Transient Rail NAND I/O 1.2 V

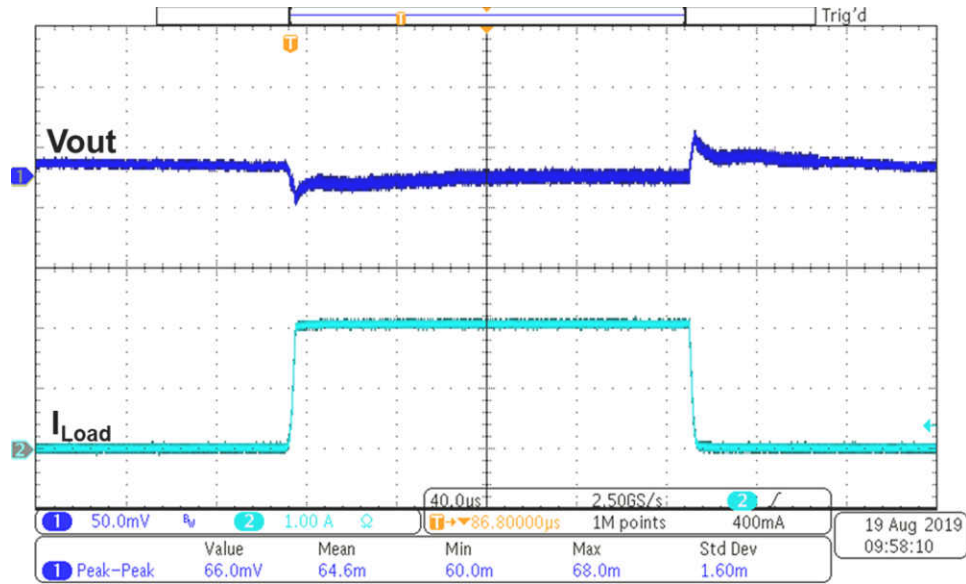

図 3-3. Vin = 3.3V, Vout = 1.2 V, ILoad 10mA to 2A and Vpp ~ ±37mV

3.1.2.4 Load Transient Rail NAND VCC 2.5 V

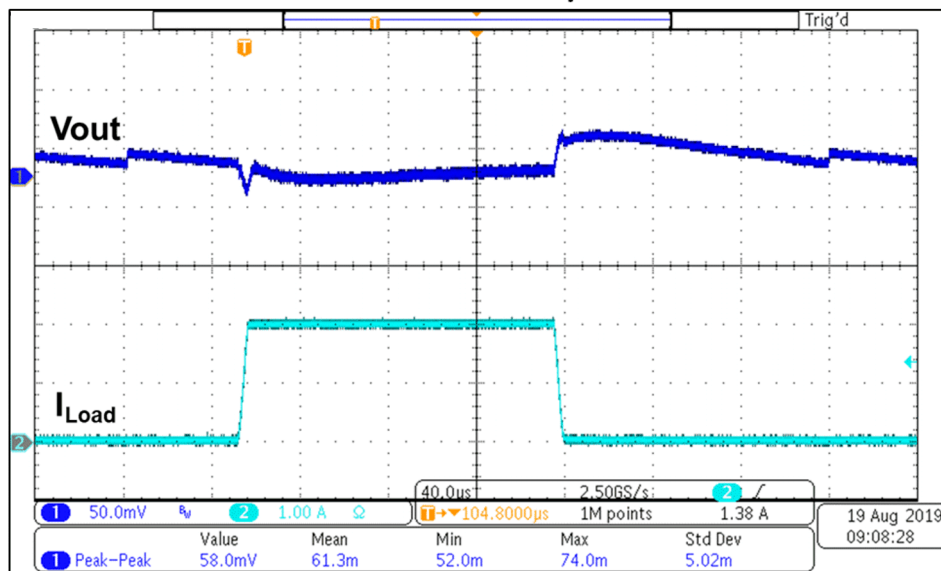

图 3-4. Vin = 3.3V, Vout = 2.5 V, ILoad 10mA to 3A and Vpp ~ ±42mV

3.1.2.5 Output Ripple Rail SoC 0.9 V

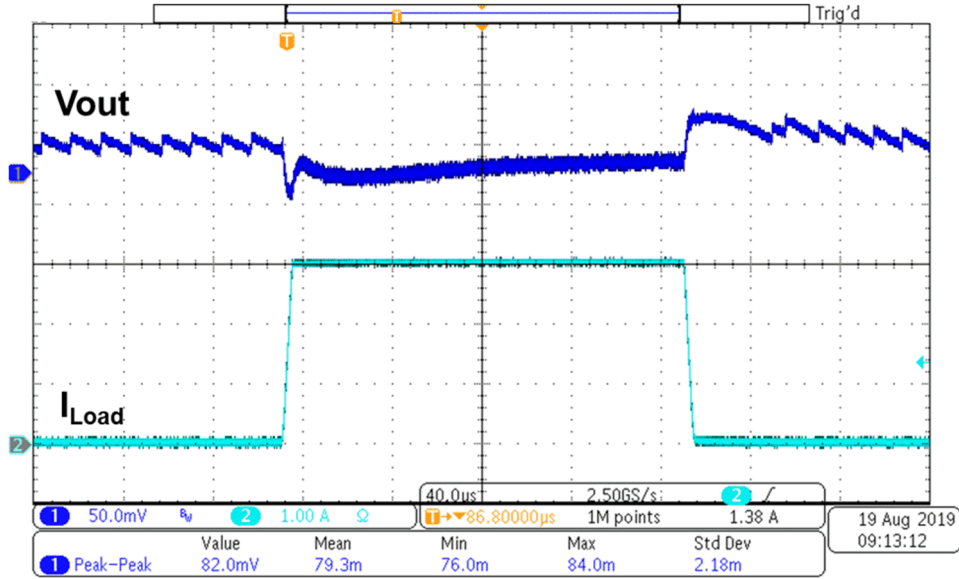

图 3-5. Vin = 3.3 V, Vout = 0.9V, ILoad = 2.0A and Vpp ~ 5mV

3.1.2.6 Output Ripple Rail NAND I/O 1.2 V

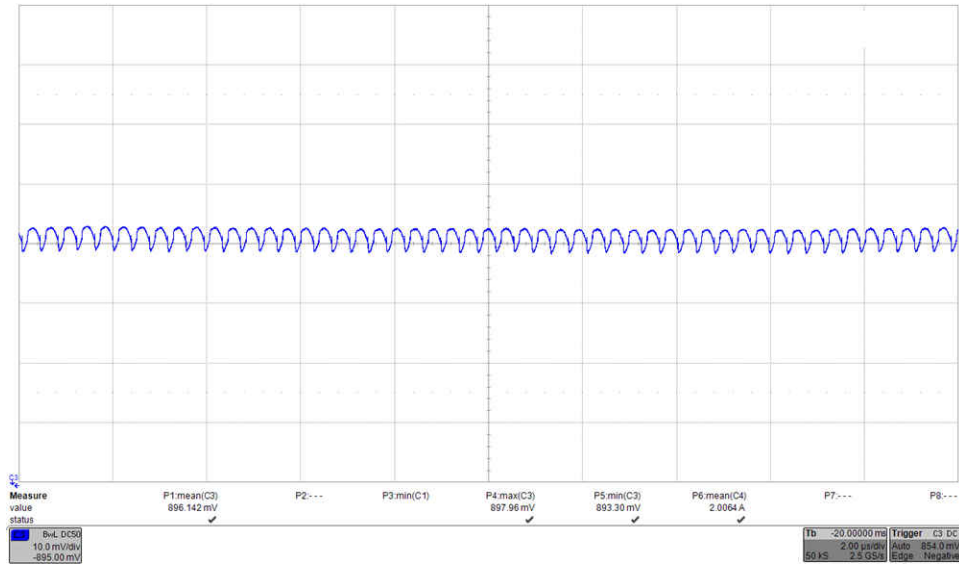

図 3-6. $V_{in} = 3.3\text{ V}$, $V_{out} = 1.2\text{ V}$, $I_{Load} = 1.2\text{ A}$ and $V_{pp} \sim 3\text{ mV}$

3.1.2.7 Output Ripple Rail NAND VCC 2.5 V

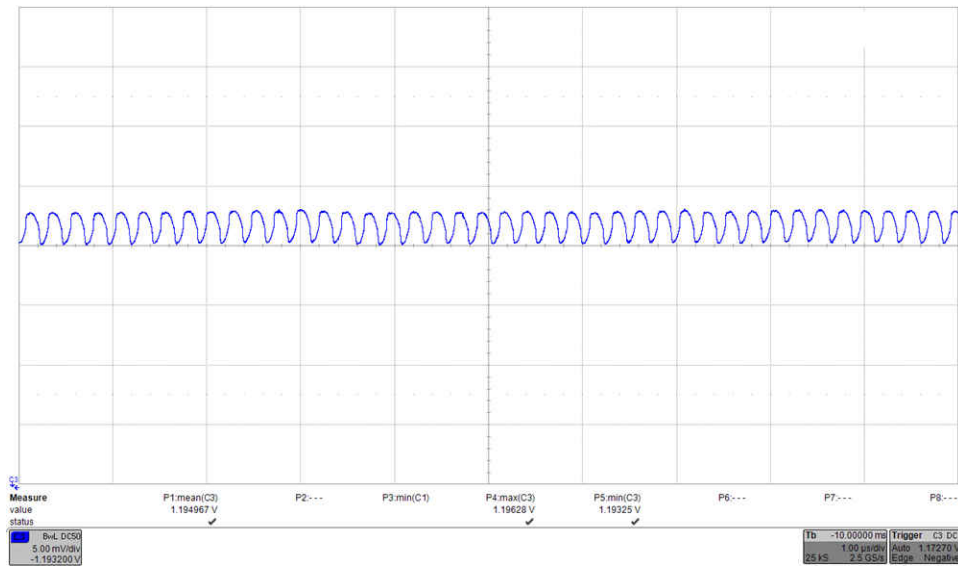

図 3-7. $V_{in} = 3.3\text{ V}$, $V_{out} = 2.5\text{ V}$, $I_{Load} = 1.7\text{ A}$ and $V_{pp} \sim 13.0\text{ mV}$

3.1.2.8 Output Ripple Rail SOC I/O 1.8 V

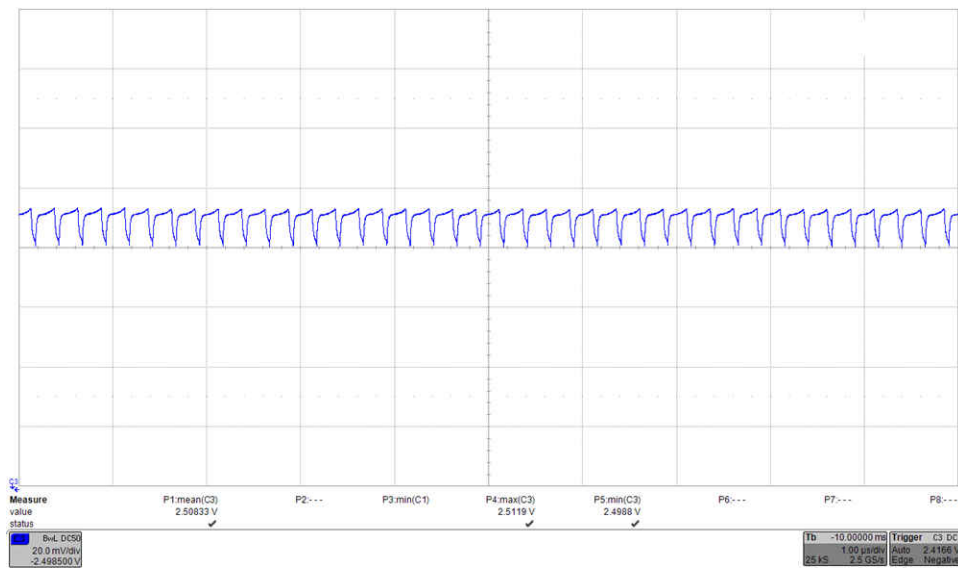

図 3-8. 3.3 V, Vout = 1.8 V, ILoad = 0.15A

3.1.2.9 Efficiency

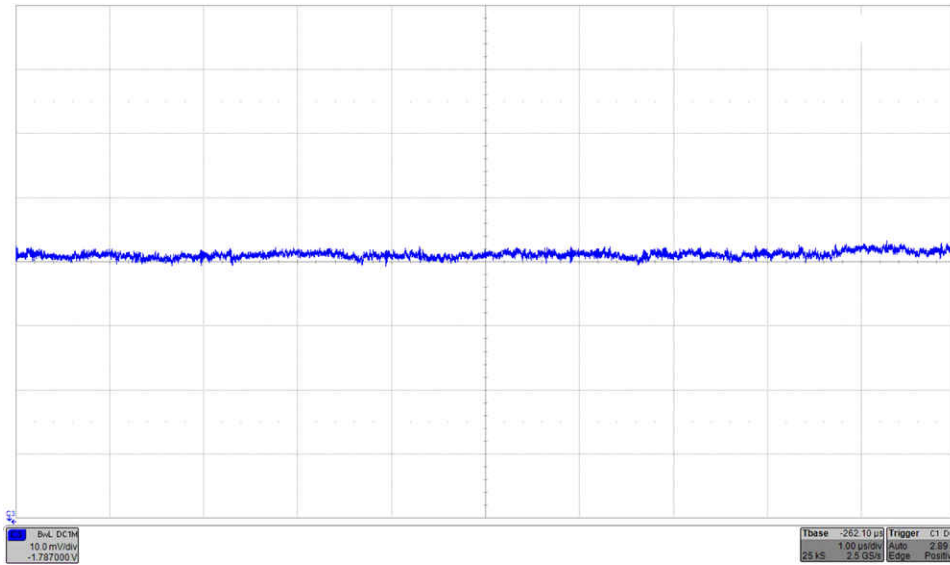

図 3-9. Efficiency

The thermal measurements were done with the following parameters:

- SoC 0.9 V – 2.0 A
- NAND I/O 1.2 V – 1.3 A
- NAND VCC 2.5 V – 1.7 A
- SOC I/O 1.8 V – 10mA

The measurements were taken after the device has been working with this load for an hour.

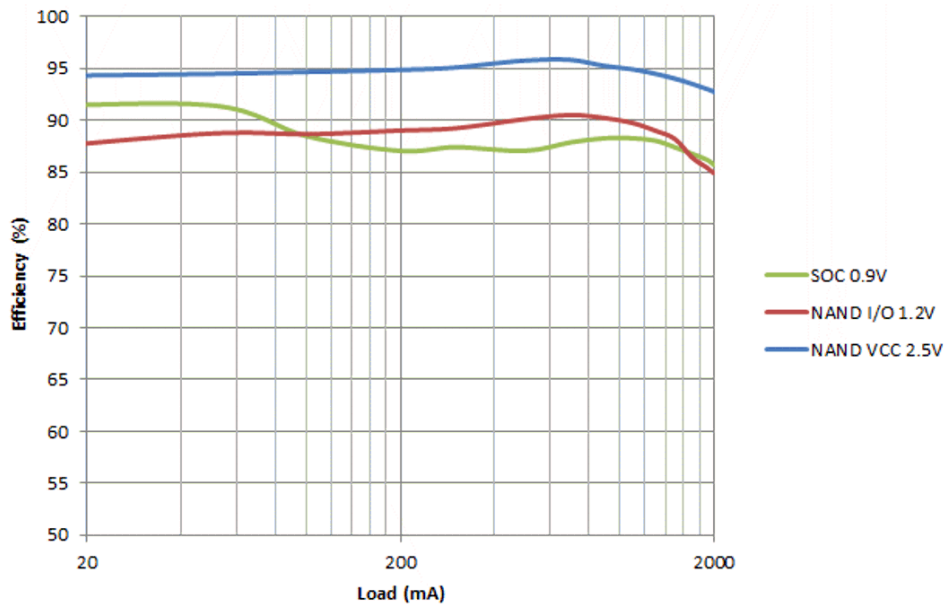

図 3-10. $V_{in} = 3.3 \text{ V}$, $I_{in} = 2.452 \text{ A}$

4 Design Files

4.1 Schematics

To download the schematics, see the design files at [TIDA-050044](#).

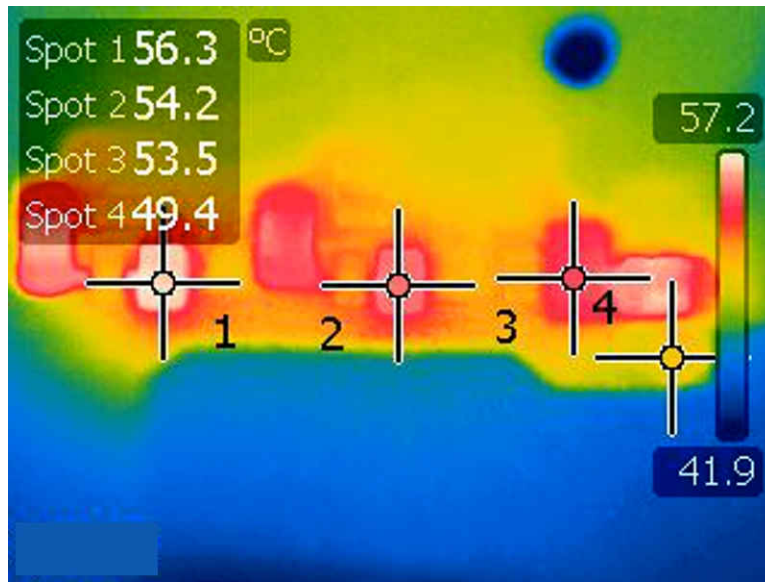
4.2 Bill of Materials

To download the bill of materials (BOM), see the design files at [TIDA-050044](#).

4.3 PCB Layout Recommendations

4.3.1 Layout Prints

To download the layer plots, see the design files at [TIDA-050044](#).

4.4 Altium Project

To download the Altium Designer® project files, see the design files at [TIDA-050044](#).

4.5 Gerber Files

To download the Gerber files, see the design files at [TIDA-050044](#).

4.6 Assembly Drawings

To download the assembly drawings, see the design files at [TIDA-050044](#).

5 Software Files

To download the software files, see the design files at [TIDA-050044](#).

6 Related Documentation

1. Texas Instruments, [TPS62864/6 2.4-V to 5.5-V Input, 4-A and 6-A Synchronous Step-Down Converter with I²C Interface in WCSP and QFN Package data sheet](#)
2. Texas Instruments, [TPS62088, 2.4-V to 5.5-V Input, Tiny 6-pin 3-A Step-Down Converter in 1.2-mm x 0.8-mm Wafer Chip Scale Package and Suitable for Embedding data sheet](#)
3. Texas Instruments, [TLV733P Capacitor-Free, 300-mA, Low-Dropout Regulator in 1-mm x 1-mm X2SON Package data sheet](#)

6.1 Trademarks

TI E2E™ is a trademark of Texas Instruments.

Altium Designer® is a registered trademark of Altium LLC or its affiliated companies.

すべての商標は、それぞれの所有者に帰属します。

6.2 Third-Party Products Disclaimer

TI'S PUBLICATION OF INFORMATION REGARDING THIRD-PARTY PRODUCTS OR SERVICES DOES NOT CONSTITUTE AN ENDORSEMENT REGARDING THE SUITABILITY OF SUCH PRODUCTS OR SERVICES OR A WARRANTY, REPRESENTATION OR ENDORSEMENT OF SUCH PRODUCTS OR SERVICES, EITHER ALONE OR IN COMBINATION WITH ANY TI PRODUCT OR SERVICE.

重要なお知らせと免責事項

TI は、技術データと信頼性データ(データシートを含みます)、設計リソース(リファレンス・デザインを含みます)、アプリケーションや設計に関する各種アドバイス、Web ツール、安全性情報、その他のリソースを、欠陥が存在する可能性のある「現状のまま」提供しており、商品性および特定目的に対する適合性の黙示保証、第三者の知的財産権の非侵害保証を含むいかなる保証も、明示的または黙示的にかかわらず拒否します。

これらのリソースは、TI 製品を使用する設計の経験を積んだ開発者への提供を意図したものです。(1) お客様のアプリケーションに適した TI 製品の選定、(2) お客様のアプリケーションの設計、検証、試験、(3) お客様のアプリケーションに該当する各種規格や、その他のあらゆる安全性、セキュリティ、規制、または他の要件への確実な適合に関する責任を、お客様のみが単独で負うものとし、

上記の各種リソースは、予告なく変更される可能性があります。これらのリソースは、リソースで説明されている TI 製品を使用するアプリケーションの開発の目的でのみ、TI はその使用をお客様に許諾します。これらのリソースに関して、他の目的で複製することや掲載することは禁止されています。TI や第三者の知的財産権のライセンスが付与されている訳ではありません。お客様は、これらのリソースを自身で使用した結果発生するあらゆる申し立て、損害、費用、損失、責任について、TI およびその代理人を完全に補償するものとし、TI は一切の責任を拒否します。

TI の製品は、[TI の販売条件](#)、または [ti.com](https://www.ti.com) やかかる TI 製品の関連資料などのいずれかを通じて提供する適用可能な条項の下で提供されています。TI がこれらのリソースを提供することは、適用される TI の保証または他の保証の放棄の拡大や変更を意味するものではありません。

お客様がいかなる追加条項または代替条項を提案した場合でも、TI はそれらに異議を唱え、拒否します。

郵送先住所：Texas Instruments, Post Office Box 655303, Dallas, Texas 75265

Copyright © 2022, Texas Instruments Incorporated