

# TI Designs: TIDA-050007

## ワイヤレス・イヤホンのバッテリー充電器用の超低スタンバイ電力リファレンス・デザイン



### 概要

最新型のワイヤレス・イヤホンは、キャリング・ケース内のバッテリーにより充電されます。これは、小さなソリューション・サイズと効率的な電力部品を必要とする独自のデザインです。さらに、この市場においては同等の機能をより安価で提供することへの要求がさらに強まり続けています。この超低電力リファレンス・デザインでは、USB入力から給電される充電ケース・バッテリーと昇圧コンバータを紹介します。

### リソース

<a href="#">TIDA-050007</a>	デザイン・フォルダ
<a href="#">TPS61099</a>	プロダクト・フォルダ
<a href="#">BQ24073</a>	プロダクト・フォルダ
<a href="#">BQ25100A</a>	プロダクト・フォルダ
<a href="#">MSP430FR2100</a>	プロダクト・フォルダ
<a href="#">TPS7A05</a>	プロダクト・フォルダ
<a href="#">TLV713P</a>	プロダクト・フォルダ

### 特長

- 非常に低いスタンバイ電流: 18μA
- 充電ケースは最大1.5Aの高速充電電流に対応
- 入力が出力よりも高い場合、パススルー・モードをサポート
- 85%を超える充電効率
- 小さなソリューション・サイズ
- イヤホンで最小1mAの充電精度をサポート

### アプリケーション

- 充電ケース
- 携帯用オーディオ製品

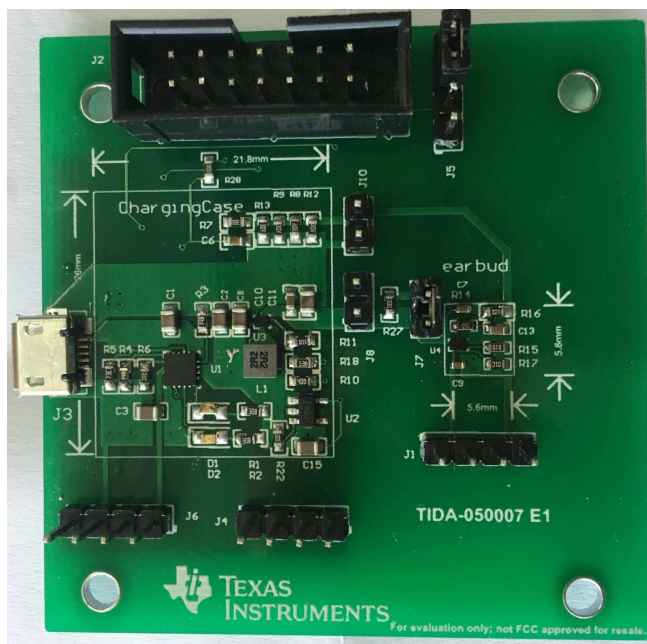
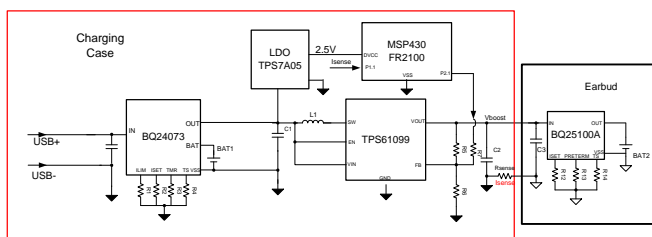
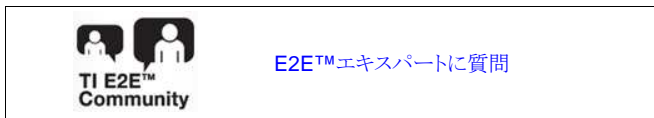



使用許可、知的財産、その他免責事項は、最終ページにあるIMPORTANT NOTICE (重要な注意事項)をご参照くださいますようお願いいたします。

## 1 Key System Specifications

表 1. Key System Specifications

PARAMETER	TEST CONDITION	VALUE
Charging Case Standby Current	No USB input, no load at boost output.	<20uA
Fast Charging Current, VBAT1	-40°C to 85°C, 5V USB	600mA
Charging Termination Current, VBAT1	-40°C to 85°C, 5V USB	10mA
Fast Charging Current, VBAT2	-40°C to 85°C, 4.5V Input	192mA
Charging Termination Current, VBAT2	-40°C to 85°C, 4.5V Input	2mA
Efficiency, VBAT1 input (4.0V) to VBAT2 output(3.6V)		>80%
Efficiency, VBAT1 input (4.0V) to VBAT2 output(4.0V)		>80%
Efficiency, VBAT1 input (4.0V) to VBAT2 output(4.2V)		>80%

## 2 System Description

The fast-growing market of charging cases brings big opportunities as well as challenges for the power designer. The limited product size drives the power efficiency to be very critical. Huge volumes also drives the market to be cost-sensitive. A good trade off should be made between the solution cost and performance.

At a high level, this reference design consists of a boost converter, a linear regulator, an MCU and three chargers. To achieve the target of ultra-low standby current, all the components should support ultra low power operation mode.

In this Ultra-low Standby Power Reference Design, a charger gets power from the USB input and charges the charging case battery (BAT1) as shown in Figure 1 block diagram. This charger supplies the boost converter as well.

The boost converter boosts up the input voltage, supplied from the OUT pin of the charger, to provide power to the batteries downstream in the earbuds.

Chargers are also needed in the earbuds to get power from the output of the boost converter to charge the batteries in the earbuds (BAT2).

Most applications have a 5.0-V fixed boost output voltage, significantly reducing the charging efficiency, especially when BAT1 is higher than BAT2. The design described here provides a new solution to extend the charging cycles by adopting an innovational pass-through mode and dynamically adjusting the output voltage of the boost converter.

To balance the cost and efficiency, the linear chargers are adopted in both the charging case and earbuds. The linear charger in the charging case should support at least 1A load and supports power path dynamic management function. Because most of the BAT1 battery has a capacity higher than 400mA·H this charger should provide the power to the boost converter at the same time. The linear chargers in the earbuds can be packaged in a very tiny size because the charging current is less than 200mA.

Enabled by TI's ultra-low power devices (Boost Converter, Linear regulator, Linear charger, and FRAM Microcontroller (MCU) ), this TI Design achieves less than 20  $\mu\text{A}$  standby current to extend charging-case battery lifetime. Less than 1.6% battery capacity is consumed by this standby current each month for a 600mA-H battery.

This design addresses component selection, design theory, and test results of the TI design system. The scope of this design guide gives system designers a head-start in integrating TI's ultra low power devices into their end-equipment systems. The following sub-sections describe the various blocks within the TI Design system.

## 2.1 *Charger in the Charging Case*

In this Reference Design, a charger that supports higher than 1 A fast-charging current is chosen so that it can also support higher charging currents in the future. A linear charger is a good choice because of the low system cost and acceptable thermal performance under this load level. If the charging current ramps higher than 1.5 A, a high-efficiency switching charger is required to avoid thermal shutdown of the charger.

The BQ24073 device is ideally suited to support up to 1.5 A fast-charging current. In addition, the BQ24073 supports input over-voltage protection up to 28 V and features dynamic power path management function, required to provide power both to the BAT1 battery and the boost converter.

The relevant system theory and design details for the BQ24073 can be found in [3.2.2](#) and [4.4](#).

## 2.2 *Boost Converter*

The boost converter is another important component in the charging case with high priority. This boost produces a stable voltage for the chargers in the downstream earbuds. Without it, the charging system will not work properly. Furthermore, this boost converter features ultra low quiescent current and high efficiency under heavy load.

With TI's broad portfolio of ultra low power boost converters, this boost converter can be easily completed. This design use TPS61099 ultra low power boost converter with less than 1- $\mu\text{A}$  quiescent current. The TPS61099 also features short-circuit protection that helps simplify the charging-case design by removing the external protection circuits.

The relevant system theory and design details of the boost converter can be found in [3.2.1](#).

## 2.3 *Charger in the earbuds*

The charger in the earbud is able to draw a stable charging current from the output of the boost converter. The size and standby current in sleep mode are the two main design concerns for this charger because of limited battery capacity. A linear charger is the only choice that needs several small ceramic capacitors and resistors to set the charging current. As a comparison, a switching charger must use large inductors and costs more.

Also, to be consistent with the pass-through mode of the TPS61099 boost converter, this charger should also support normal charging with a 3.6-V input voltage. This helps to improve the charging efficiency, especially with a fresh BAT1 battery and an empty BAT2 battery.

The BQ25100A is the optimized solution for this TI design that supports operation down to 3.3 V input by disabling the input dynamic power path function and still keeps the charging accuracy. The BQ25100A also features of ultra low quiescent current in sleep mode with less than 100 nA if no input power is detected. To fit in the small area of the earbud, the BQ25100A is packaged in a tiny WCSP package with only 1.6mm × 0.9mm size.

The relevant system theory and design details can be found in [3.2.6](#) and [4.3](#)

## 2.4 System MCU

To achieve high charging efficiency, this TI Design has several requirements for the system MCU. As the BAT1 battery capacity is limited because of the charging-case size, the quiescent current of the MCU is also very critical. The MCU needs an ADC channel to detect the charging activity and regulate the operation mode of the boost converter as well.

The MSP430FR2100 device is selected as the system MCU because of the high performance and low cost. The relevant system theory, design details and code flow chart can be found in [☒ 10](#) .

### 3 System Overview

#### 3.1 Block Diagram



図 1. TIDA-050007 Block Diagram

#### 3.2 Highlighted Products

This Reference Design features the following devices:

- [TPS61099](#): Ultra low power boost converter with 800nA quiescent current.
- [BQ24073](#): Linear charger integrates dynamic power path management and support up to 1.5A fast charging current.
- [BQ25100A](#): Ultra low power linear charger with 65nA quiescent in sleep mode and supports 1mA charging accuracy.
- [TPS7A05](#): Ultra low power linear regulator support up to 100mA.
- [TLV713P](#): Low cost linear regulator with less than 50µA quiescent current.
- [MSP430FR2100](#): Ultra low power MCU with 8-channel ADC inside.

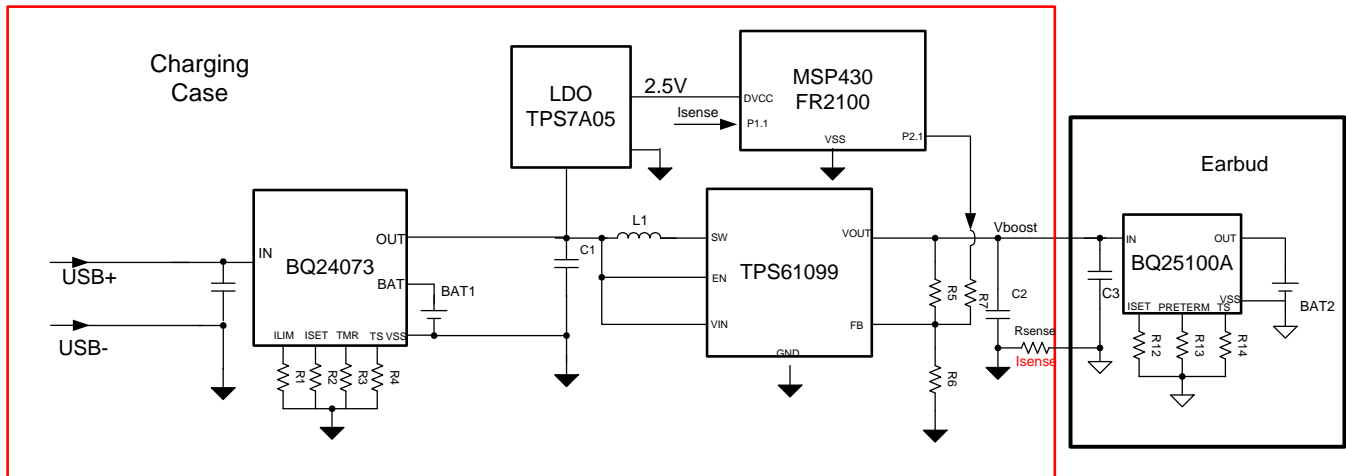
For more information on each of these devices, see their respective product folders at [www.ti.com](http://www.ti.com).

##### 3.2.1 TPS61099

The TPS6199 is an ultra-low quiescent current and high-efficiency boost converter. The quiescent current into VOUT pin is only 600 nA. The TPS61099 is capable of delivering 5.0 V and 400 mA load from a 3.3-V input voltage with higher than 90% efficiency. The TPS61099 operates at a 1.2-MHz switching frequency and can be shut down through the EN pin with a 0.5-µA shutdown current. The TPS61099 also supports down mode and pass-through mode if the input voltage is close to or higher than the output voltage. The TPS61099 provides 5.8-V output over-voltage protection, output short-circuit protection, and shutdown protection. During short circuit protection, the input current limit is clamped at 200 mA. The TPS61099 is available in a 1.23-mm×0.88-mm WCSP package.

The TPS61099 adopts a hysteresis current control method and 図 2 shows the block diagram of TPS1099.

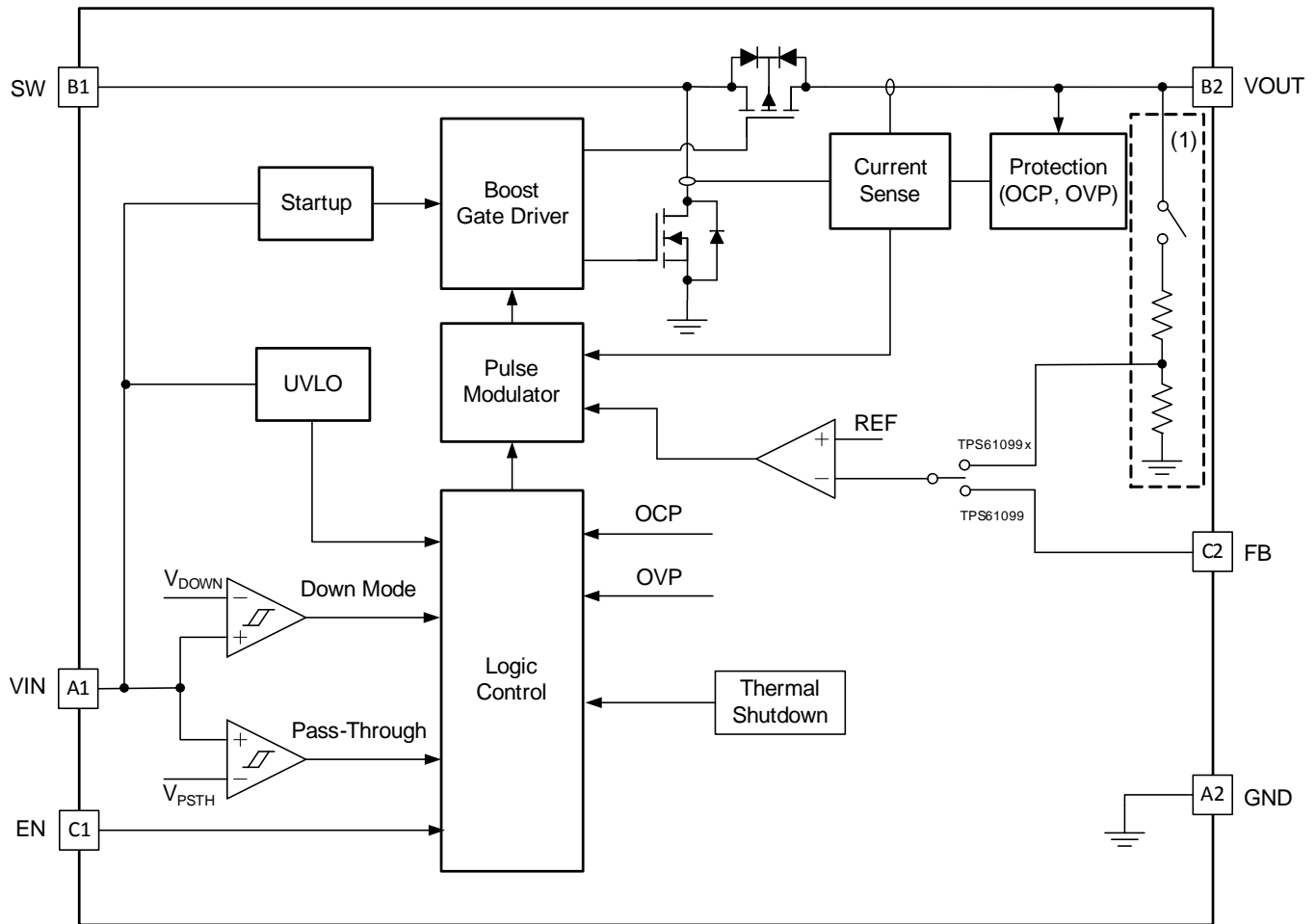

Copyright © 2017, Texas Instruments Incorporated

**図 2. TPS61099 Block Diagram**

### 3.2.2 BQ24073

The BQ24073 operates from either a USB or an AC adapter and support charge currents up to 1.5 A. The device powers the system while simultaneously and independently charging the battery. This feature reduces the number of charge and discharge cycles on the battery, allows for proper charge termination and enables the system to run with a defective or absent battery pack.

The input voltage range with input overvoltage protection supports unregulated adapters. The USB input current-limit accuracy and start-up sequence allow the bq2407x to meet USB-IF inrush current specifications. Additionally, the input dynamic power management (VIN-DPM) prevents the charger from crashing incorrectly configured USB Wall Adapter sources. The bq2407x features dynamic power path that powers the system and charges simultaneously. The DPPM circuit reduces the charge current when the input current limit causes the system output to fall to the DPPM threshold; thus, supplying the Safety Timers system load at all times while monitoring the charge current separately. The sleep current into BAT pin is at 6.5- $\mu$ A maximum.

図 3 shows the battery charger flow diagram.



図 3. Battery Charging Flow Diagram

### 3.2.3 MSP430FR2100

The ultra-low standby Power Reference Design has several requirements for the system micro-controller unit (MCU). The MCU should have a DAC or GPIO to adjust the output voltage of the boost converter. As the battery voltage rises slowly when charging, the output voltage of the boost converter TPS61099 can be adjusted by the duty cycle of PWM signal directly from a GPIO pin. The MCU should also support ADC channels. The ADC in the MCU samples the charging current of BQ25100A so as to adjust the duty cycle and determine if the system should be in sleep mode to save power. The MSP430FR2100 offers a memory size of 1 KB of FRAM unified memory with a 5-mm×4.4-mm TSSOP package. The architecture, FRAM, and integrated peripherals, combined with extensive low-power modes, are optimized to achieve extended battery life in portable, battery-powered sensing applications. MSP430FR2100 offers a migration path for 8-bit designs to gain additional features and functionality from peripheral integration and the data-logging and low-power benefits of FRAM. The MSP430FR2100 features a powerful 16-bit RISC CPU, 16-bit registers, and a constant-current generator that contribute to maximum code efficiency. The digitally controlled oscillator (DCO) also allows the device to wake up from low-power modes to active mode typically in less than 10  $\mu$ s. The feature set of this MCU meets the needs of applications ranging from appliance battery packs and battery monitoring to smoke detectors and fitness accessories. The MSP ultra-low-power (ULP) FRAM microcontroller platform combines uniquely embedded FRAM and a holistic ultra-low-power system architecture. This allows system designers to increase performance while lowering energy consumption. FRAM technology combines the low-energy fast writes, flexibility, and endurance of RAM with the nonvolatile behavior of flash. The MSP430FR2100 also integrates an 8-channel 10-bit analog-to-digital converter (ADC)

### 3.2.4 TPS7A05

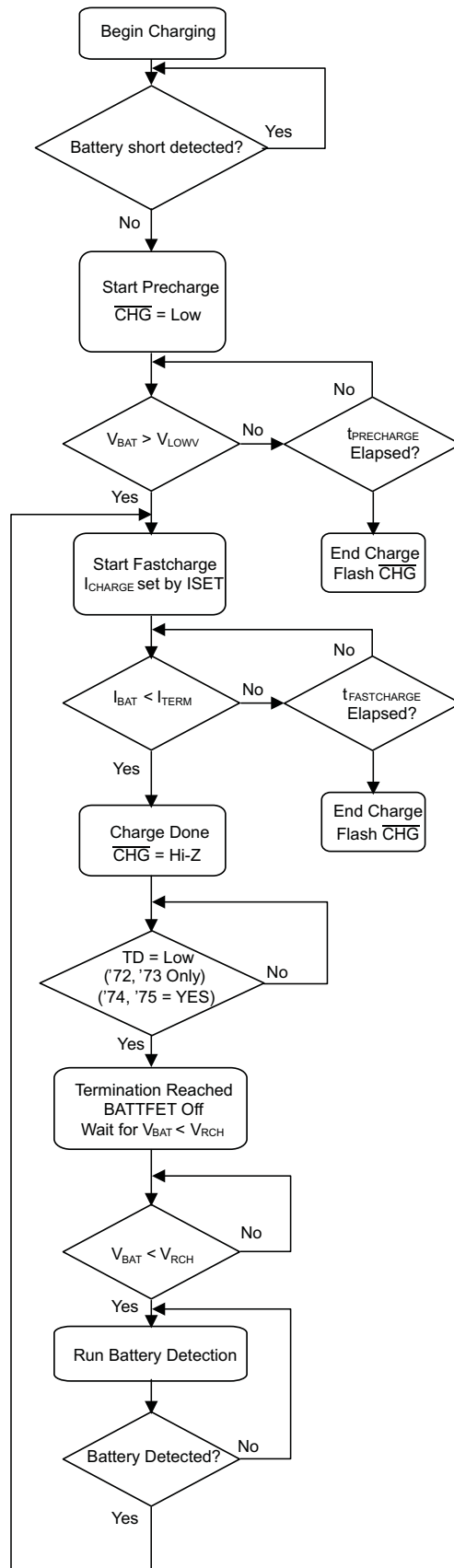
The LDO is used to generate a stable 2.5 V power rail for the MCU, that needs a DVCC power rail in the range of 1.8 V to 3.6 V. The TPS7A05 device is an ultra-small, low quiescent current low-dropout regulator (LDO) that can source 200 mA with excellent transient performance. This device outputs a fixed 2.5-V with a typical 1% accuracy to the MCU. The TPS7A05, with ultralow IQ (1  $\mu$ A), is designed specifically for battery-powered applications where very-low quiescent current is a critical parameter for extending battery life. The device can be operated from rechargeable Li-Ion batteries, Li-primary battery chemistries such as Li-SOCl<sub>2</sub>, Li-MnO<sub>2</sub>, as well as two- or three-cell alkaline batteries. The TPS7A05 is available with an active pulldown circuit to quickly discharge output loads when disabled. The TPS7A05 is fully specified for T<sub>J</sub> = -40°C to +125°C operation, and is available in SOT-23 (DBV) package.

### 3.2.5 TLV713P

The TLV713P device is a capacitor free, low quiescent current linear regulator with excellent line and load transient performance and are designed for power-sensitive applications. It is pin-to-pin compatible with the TPS7A05 device.

The quiescent current of TLV713P is 50  $\mu$ A. This is larger than 1  $\mu$ A for the TPS7A05; but, the TLV713P is good for the cost-sensitive applications.

### 3.2.6 BQ25100A

The BQ25100A is a highly integrated linear charger targeted at space-limited portable applications. The high input voltage range with input overvoltage protection supports low-cost unregulated adapters. The BQ25100A has a single power output that charges the battery. A system load can be placed in parallel with the battery as long as the average system load does not keep the battery from charging fully during the 10-hour safety timer. The battery is charged in three phases: conditioning, constant current and



constant voltage. In all charge phases, an internal control loop monitors the IC junction temperature and reduces the charge current if an internal temperature threshold is exceeded. The charger power stage and charge current-sense functions are fully integrated. The charger function has high-accuracy current (down to 1 mA charging current accuracy), voltage regulation loops, and charge termination. The pre-charge current and termination current threshold are programmed via an external resistor. The fast-charge current value is also programmable via an external resistor.

Additionally, the Dynamic Path Management function ( $V_{IN\_DPM}$ ) is disabled in the BQ25100A. This feature supports charging even with a 3.6-V input voltage. This function also helps to improve the charging efficiency when the battery voltage in the charging case is higher than the voltage in the earbuds.

The BQ25100A cuts the charge current level in half between 0°C and 10°C, and disables charging when the NTC resistor is above 45°C as shown in 図 4.



図 4. Operation over TS Bias Voltage

図 5 shows the Power-up sequence of BQ25100A.

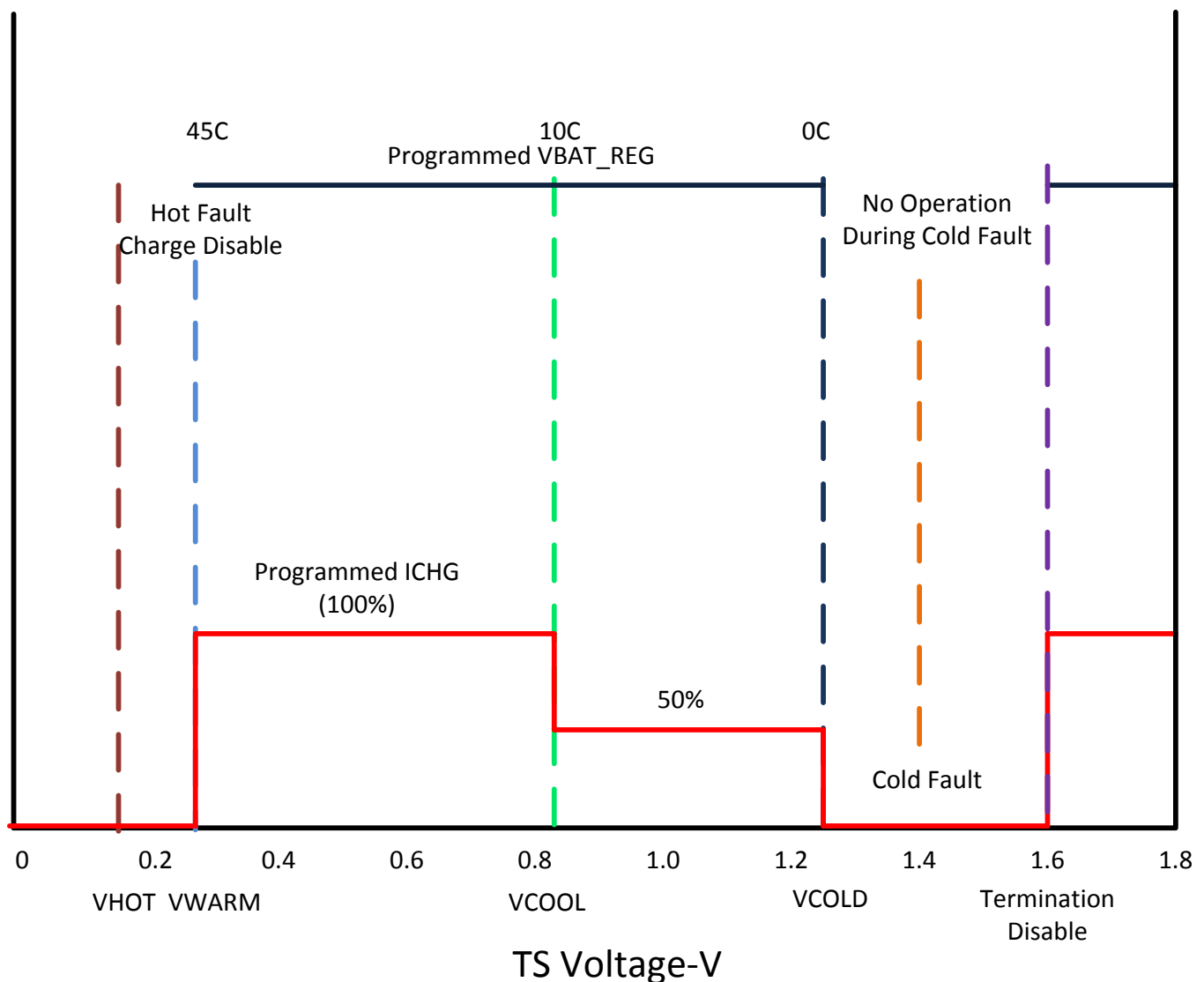

図 5. BQ25100A Power Up Flow

## 4 System Design Theory

This design demonstrates an ultra-low power, high efficiency and high-integration power system from the USB input to the batteries in the earbuds. The BQ24073 charger is a compact linear charger that can support up to 1.5 A fast-charging current that supplies power to the BAT1 battery and the boost converter.

The MCU wake-up occurs every 5 seconds to exit from low-power mode and enters active mode to detect if earbuds are inserted. In active mode, the ADC samples the output current of the boost converter (that is, the charging current to the earbuds). The MCU adjusts the PWM duty cycle to determine when to enter pass-through mode and changes the boost output voltage according to the sensed charging current value. In this way, the boost output voltage follows the BAT2 voltage. This scheme helps reduce significant power loss during charging, especially if the BAT1 voltage is higher than BAT2 (a fresh BAT1 battery to an empty BAT2 battery). The boost converter stays in pass-through mode rather than boost mode under this condition.

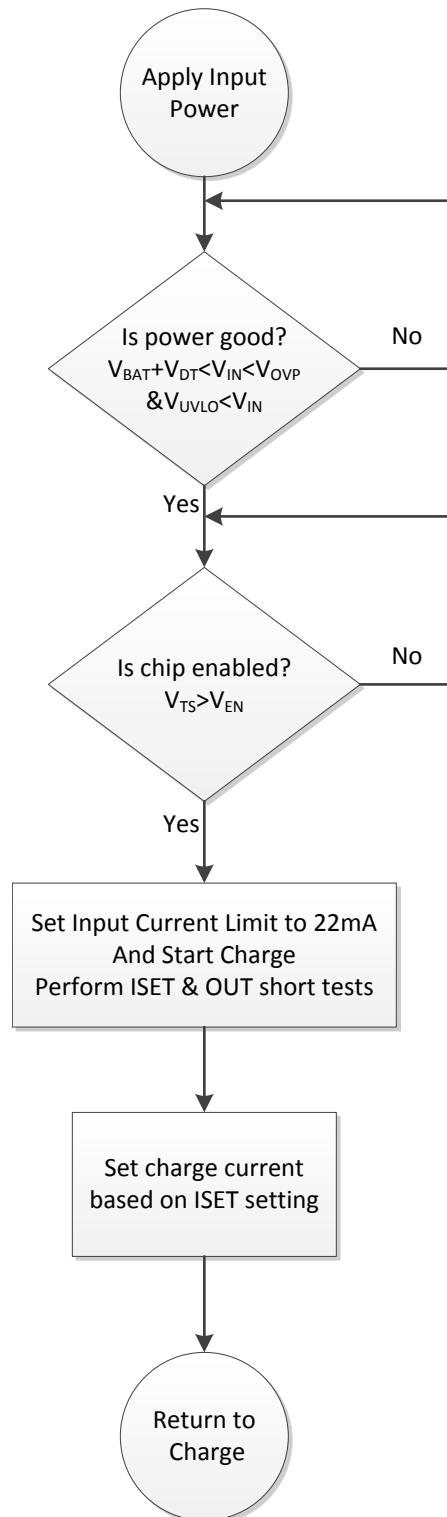
### 4.1 Boost Converter Design

The ultra-low power boost converter is used to generate a stable voltage to the BQ25100A. The BQ25100A linear charger is connected to the boost output directly. The TPS61099 also supports pass-through mode and voltage tracking function. These functions are achieved by adding an external bias voltage at FB pin. During the sleep mode of the whole system (no earbuds inserted in the charging case), the MCU GPIO P2.1 output low level and the boost outputs the highest voltage of 5.0 V. This helps ensure the charging case can output a normal charging current set by the BQ25100A even with a full BAT2 battery. To conserve power even further, the output voltage is adjustable in active mode. The output voltage is adjusted so that the boost output voltage will always be only a controlled level higher than the BAT2 battery voltage. If the charging current exceeds the target charging current threshold, the boost output is reduced. Otherwise, the output voltage increases to keep the charging current regulated. when BAT2 ramps up to a value higher than 4.16 V, the charger current reduces to less than the 30 mA threshold and the boost output voltage is clamped at the highest level of 5 V. 図 6 shows the TPS61099 control schematic. The PWM signal from one GPIO of the MCU is filtered to a DC bias and added on the FB pin. Otherwise, the TPS61099 will not work normally.



図 6. TPS61099 Control Schematic

図 7 Show the efficiency of TPS61099 under different output voltage conditions. The TPS61099 has an efficiency higher than 90% at 100 to 200 mA output load when the boost output voltage is between 3.6 V and 4.5 V from a 2.4-V input. The efficiency can be higher than this value if the input voltage is higher than 2.4 V.

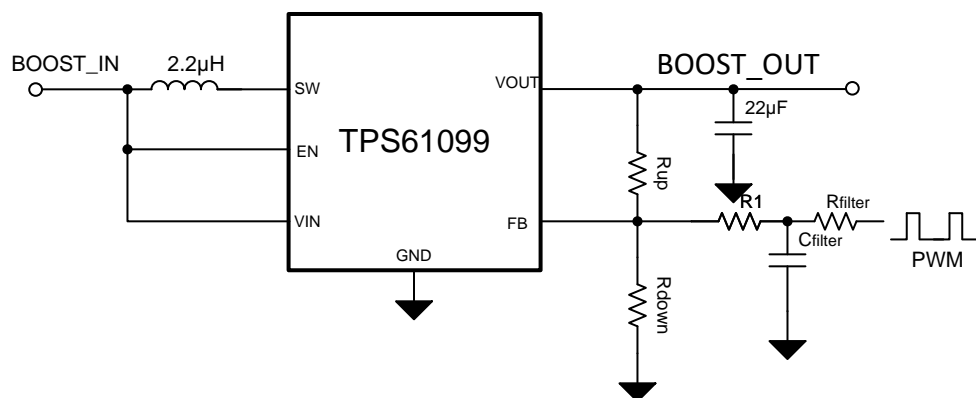

図 7. TPS61099 Efficiency vs Different Input Voltages

As shown in 図 8, TPS61099 has three operation modes: boost mode, down mode, and pass-through mode. Applications can benefit from the down mode if they need a stable output voltage even when the input voltage is higher than the output voltage. The down mode can also share the thermal load from the BQ25100A charger to avoid the BQ25100A entering thermal shutdown. This is a good feature under heavy load and high voltage drop conditions. In the pass-through mode, the boost converter stops switching, the rectifying PMOS constantly turns on and the low-side switch turns off. In this example, the pass-through mode is very critical to improving the charging efficiency by sending the BAT1 voltage to the BQ25100A directly.

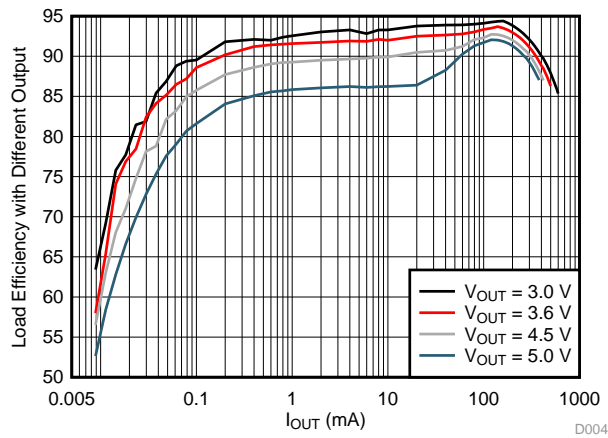

図 8. TPS61099 Operation Mode

The resistor divider and filter resistor can be calculated according to the equations (1) and (2).

$$\frac{V_{out} - 1}{R_{up}} + \frac{GND - 1}{(R_1 + R_{filter})} = \frac{1}{R_{down}} \tag{1}$$

$$\frac{V_{out} - 1}{R_{up}} + \frac{DVCC - 1}{(R_1 + R_{filter})} = \frac{1}{R_{down}} \tag{2}$$

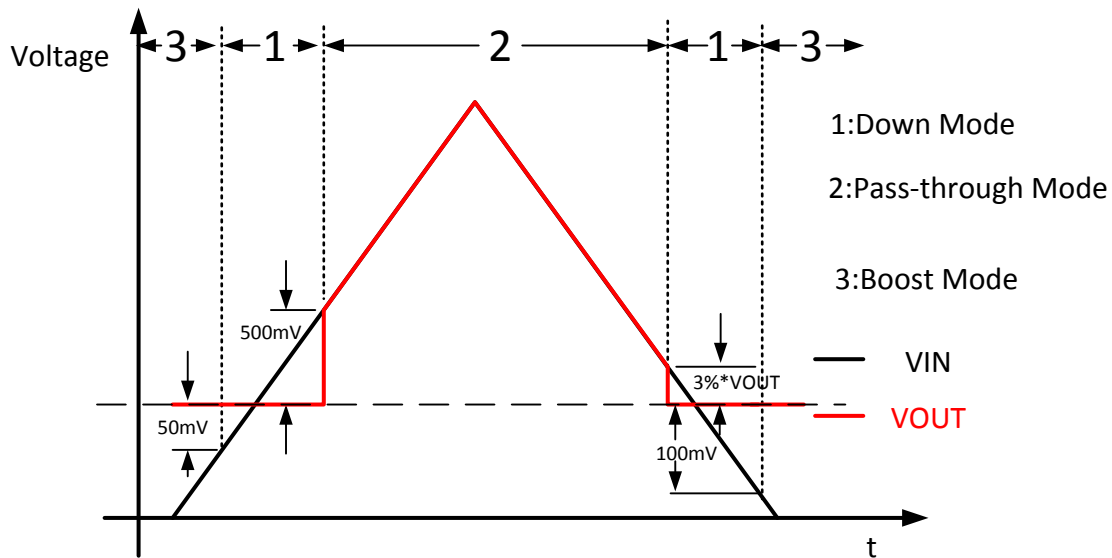
In this example, the lowest output voltage is set to 2.0 V and the highest voltage is 5.0 V. The upper resistor ( $R_{UP}$ ) is set to 1 M $\Omega$  by default, then the low side  $R_{down}$  is 357 k $\Omega$  and ( $R_1+R_{filter}$ ) is 837k $\Omega$ . To make the filter more smooth, 337 k $\Omega$  is selected for  $R_1$  and 500 k $\Omega$  is selected for  $R_{filter}$ . The filter capacitor is a 0.1- $\mu$ F capacitor. To reduce the leakage current further, these resistors can be double the resistance.

Figure 9 shows the linearity of this regulation.

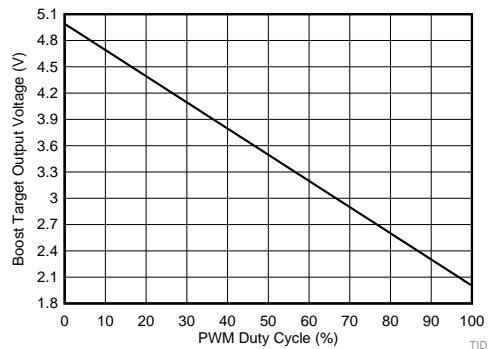

Figure 9. TPS61099 Output Voltage vs. Different Duty Cycle

## 4.2 MCU Control Design

An  $R_{SENSE}$  sampling resistor is used to sample the charging current to the earbuds. To minimize the power loss on the sampling resistor, the voltage drop on the resistor should be set to less than 100 mV, being less than 2.5% power loss for an average 4.2-V boost output voltage. In this example, the regulated voltage on the  $R_{sense}$  is set to 54 mV and a resistor combination with a 0.315 $\Omega$  resistance is used. This means the charging current is regulated at 171.4mA. Please keep in mind that this voltage drop should always be a little less than the BQ25100A current limit. Otherwise, the MCU will always output the minimum duty cycle PWM signal and the boost output voltage is clamped at 5 V. To leave some margin, a higher-than 5% but less-than 15% difference is recommended to get an accurate regulation.

Special attention should be paid on the charging current sampling because of the PCB layout. An R-C filter is used to get an average charging current. The time constant of the R-C filter should avoid the audio band which is 20 Hz-20kHz. A 100k $\Omega$ - 100nF filter is recommended. Additionally, to avoid high frequency noise influence, a 1-nF decoupling capacitor is used to filter out the high frequency noise. This capacitor should be placed as close as possible to the MCU ADC input pin (In this example, it is P1.1).

The MCU control flow is shown in Figure 10, this flow has 4 purposes:

- Enters ultra low power mode (LPM3.5) to save power in standby mode if no load is detected.
- Exits LPM 3.5 and enters normal operation when load is detected.
- Determine when TPS61099 enters pass-through mode to improve the charging efficiency.
- Adjust the boost output voltage to track the BAT2 voltage by sampling the charging current.

In this flow, the P2.1 output a low level signal and the boost output is 5 V when the MCU stays in LPM3.5 mode. This helps wake up the MCU as soon as possible.

After a load is detected, the P1.1 outputs a high level signal and the boost is set to 2 V immediately. Then the MCU starts sensing the charging current. If this value is higher than the target charging current, the P1.1 keeps outputting a high logic and The TPS61099 stays in pass-through mode. This means the BAT1 voltage is high enough to charge the BAT2 battery and the TPS61099 does not need to boost up. This is because the BQ25100A has a higher current limit than the target charging current as mentioned above.

Otherwise, the P2.1 outputs an adjustable duty cycle PWM to change the boost output voltage to track the BAT2 voltage. The ADC samples are averaged and some hysteresis is added to avoid oscillation.



図 10. MCU Flow Chart

The PWM output at P2.1 is a fixed 10 kHz. This is generated by the Timber\_B module. The duty cycle is dynamically changed according to the charging current. The ADC has a sampling rate of 6 ksps.

The following equation is used to calculate the  $R_{SENSE}$  resistor to get the desired target charging current.

$$R_{SENSE} = \frac{V_{ref}}{I_{target}} \quad (3)$$

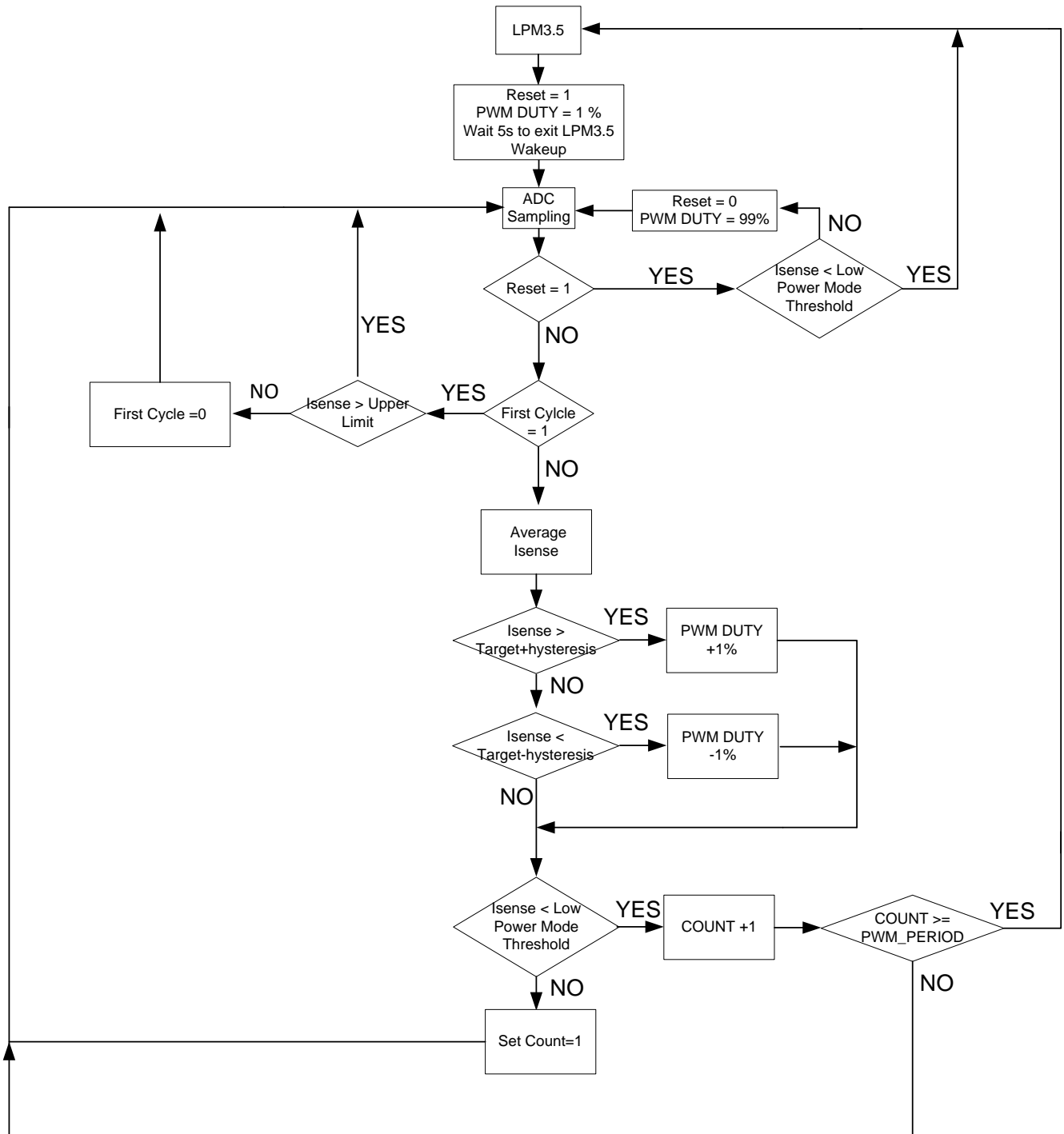
Where

- $V_{ref}$  is the regulated voltage drop set by the MCU. In this example, this value is 54 mV typically.
- $I_{target}$  is the target charging current required by the application.
- $R_{SENSE}$  is the sense resistance needed to set the target charging current.

In this example, the target charging current is set to 172 mA, which means the resistor of  $R_{SENSE}$  is 0.315Ω. The resistor can be combined with two 1-Ω resistor, one 1.5-Ω resistor and one 2-Ω resistor in parallel.

An internal parameter COUNT is used to determine when to enter low-power mode (LPM3.5). If the COUNT value exceeds the threshold of PWM\_PERIOD, the system enters ultra-low-power mode and the P2.1 outputs a low level signal.

Additionally, 14s is needed to exit active mode to LPM3.5 if no load is detected.

### 4.3 BQ25100A Design

BQ25100A is the linear charger in the earbud that has its VIN-DPM function disabled as mentioned above. In this way, the BQ25100A can still charge the BAT2 battery even with a 3.6-V input voltage. This function helps improve the efficiency with the help of pass-through mode of the TPS61099. This function works well when the BAT1 voltage is higher than the BAT2 voltage, especially a fresh BAT1 battery to charge an empty BAT2 battery. The key design points for BQ25100A is the current limit. The current limit is set to 192 mA. This is 10% higher than the target regulated charging current 172 mA. The reason why the current limit is set to 5% to 15% above the regulated charging current is because if the current limit is set much higher than the regulated charging current, the actual charging current will touch the current limit when TPS61099 works in high efficiency pass-through mode. Additionally, the MCU uses the difference between these two currents ( $I_{target}$  and  $I_{LIMIT}$ ) to accelerate the loop response as mentioned above. If the voltage on  $R_{SENSE}$  is higher than the  $V_{ref}$  during startup, the system maintains this state and the TPS61099 can stay in pass-through mode all the time.

The fast-charge current can be calculated with :  $R_{ISET} = [135 \text{ A}\Omega / 0.192 \text{ A}] = 703\Omega$ , a standard 698 Ω resistor in series with a 5 Ω resistor can be used.

The termination current threshold is set to 2mA, then the resistance can be calculated with  $R_{PRE-TERM} = 600 \Omega / \% \times 1\% = 600\Omega$

### 4.4 BQ24073 Design

BQ24073 is the linear charger in the charging case that supports the charging current to BAT1 battery and system current. In this design the maximum charging current is set to 600 mA because a 600-mA-H BAT1 is used. The maximum load for TPS61099 is 400 mA to charge two BAT2 batteries. When a USB connector is plugged in, the output of the BQ24073 is 4.3 V minimum which means the worst case of the TPS61099 boost converter will be 4.3 V input and 4.6 V 400mA output. The boost efficiency is about 95% under this conversion and the input current can be calculated out as 450 mA. The total current consumption is 1050 mA. In this way, the current limit of BQ24073 is set to 1.1 A with 5% margin. According to the datasheet of BQ24073, a 1.48-kΩ resistor is connected between ISET and GND. A 1.40-kΩ resistor is connected between ILIM and GND setting the current limit to 1.1 A.



The termination function of BQ24073 can be disabled by connecting TD pin to high logic. In this example the TD pin is connected to ground which implies a ???

The fast charge current can be calculated with :  $R_{\text{SET}} = [890 \text{ A}\Omega / 0.6 \text{ A}] = 1.483 \text{ k}\Omega$ , the closest standard resistor is 1.47 k $\Omega$ .

The current limit can be calculated with :  $R_{\text{LIM}} = [1550 \text{ A}\Omega / 1.1 \text{ A}] = 1.409 \text{ k}\Omega$ , the closest standard resistor is 1.40 k $\Omega$ .

## 5 Getting Started

### 5.1 Required Hardware

#### 5.1.1 Hardware Overview

The hardware of this Reference Design is shown in [Figure 11](#). The size of the charging case is only 21.8 mm × 26 mm and the earbuds PCB is only 5.6 mm × 5.8 mm. Jumper J7 is used to imitate the insertion or removal of the earbuds.

All the main power ICs are located on the top side of the PCB, including the linear charge BQ24073, ultra low power boost converter TPS61099, linear regulator TPS7A05 and the linear charger BQ25100A. The MCU is located on the bottom side of the PCB along with a few passive components.

The TI Design hardware is programmed by connecting the 14-pin JTAG ribbon cable from J2 to the MSP430 Flash Emulation Tool through CCS. Connector J5 is used to select different power supplies when programming. In default, connect to DVCC using a jumper when programming.



図 11. Hardware

## 5.2 Demonstrating the TI Design Hardware

By default, the TI Design hardware can charge the earbuds automatically.

Remove the jumper J7 to measure the standby current.

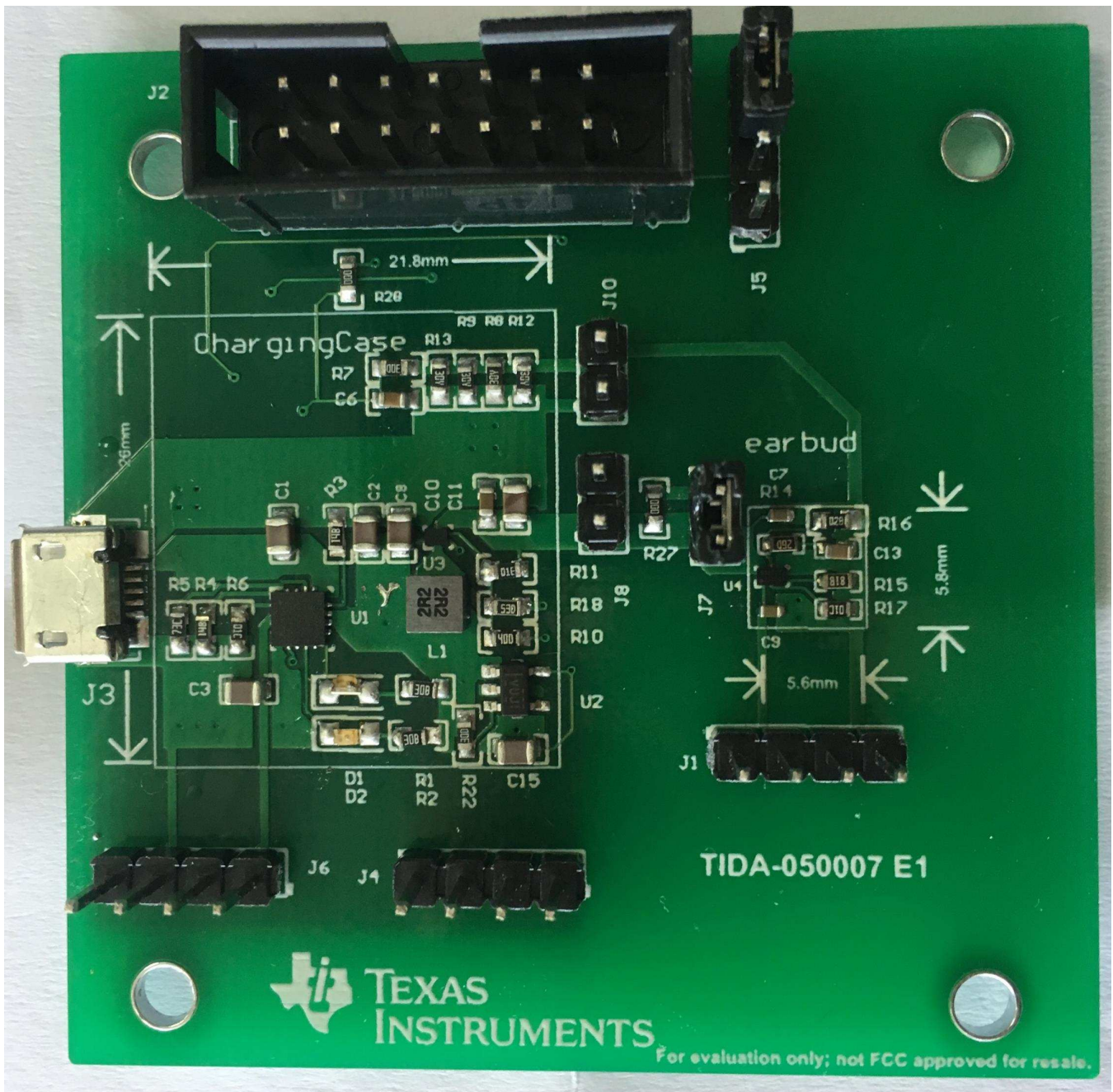
## 6 Testing and Results

The ultra-low standby power reference design for wireless earbuds battery charger has been characterized for functional usage including the steady state DC performance, power consumption and voltage tracking function. Different power supplies are used to imitate the BAT1 battery and BAT2 battery . All the test results are under room temperature conditions. The power consumption and switching waveforms in steady state are measured and captured. The results are shown in the below sections.

### 6.1 Test Setup

☒ 12 shows the hardware setup of this TI Design.

The no-load current and BAT1 to BAT2 charging efficiency are measured in the following sections.

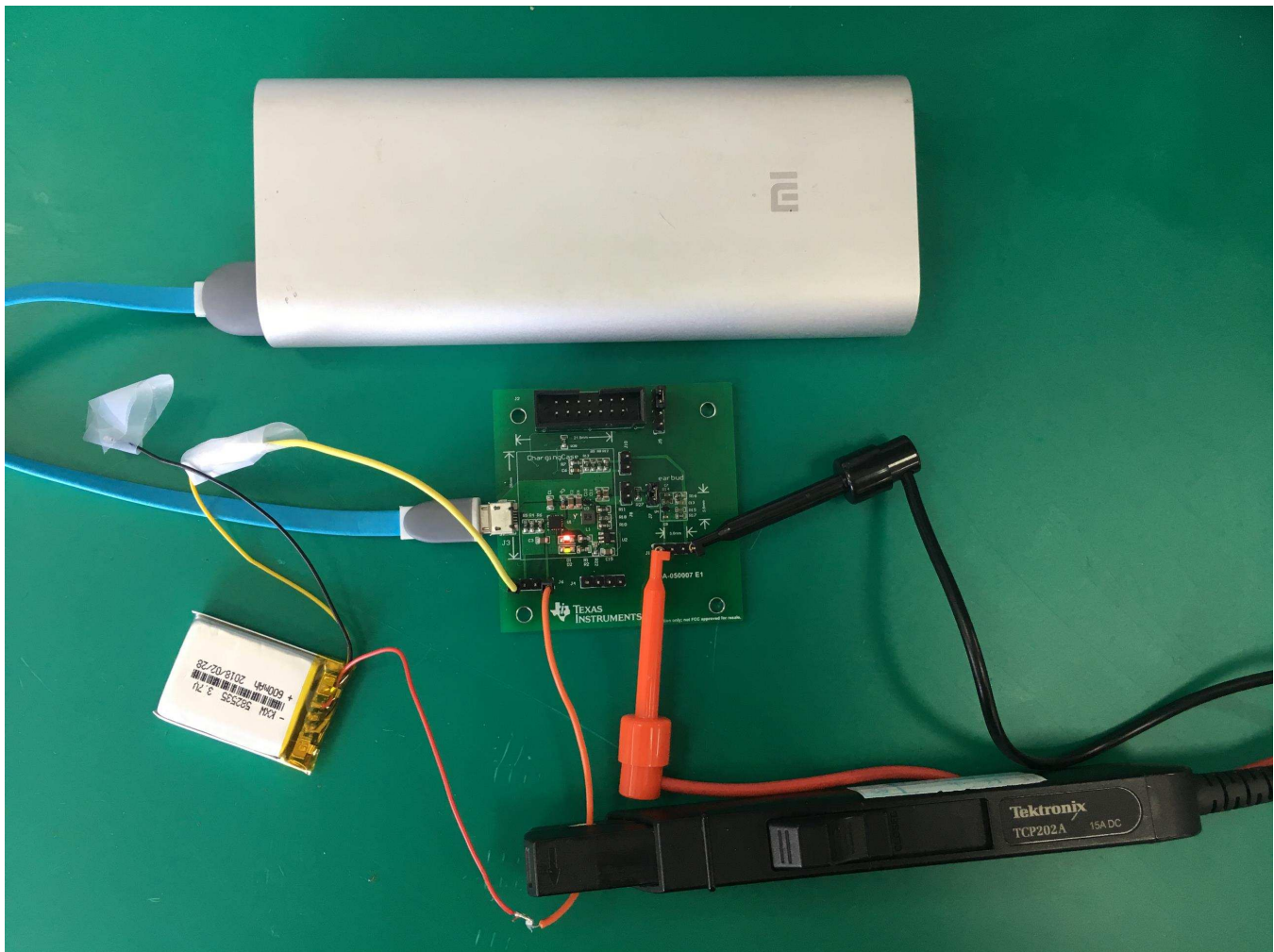

☒ 12. Test Setup

### 6.2 Typical Characteristics

In this test, a DC power supply is used to imitate the BAT1 battery.

As described in 2 , this TI Design is intended to achieve less than 20  $\mu\text{A}$  no load current from BAT1 battery when no earbud is inserted and no USB is plugged in. No load current of 18- $\mu\text{A}$  is achieved consisting of 4 portions:

- The load of TPS61099 in standby mode is: 600 nA quiescent current and 4  $\mu$ A leakage current from the Boost Output to GND (this is caused by the resistor divider having a 1.25-M $\Omega$  resistance). This input current is equal to 9.1  $\mu$ A with 70% conversion efficiency at 3.6 V input.
- The quiescent current of the MSP430FR2100 is <1  $\mu$ A in Low Power Mode LPM3.5.
- The quiescent current of the LDO TPS7A0525 is 1  $\mu$ A.
- The sleep current of the BQ24073 is 6.5  $\mu$ A maximum.

**表 2. DC Characteristics**

PARAMETER	TEST CONDITION	VALUE
Charging Case Standby Current	No USB input, no load at boost output. VBAT1=3.6V	18 $\mu$ A
Fast Charging Current, VBAT1	-40°C to 85°C, 5V USB	600mA
Charging Termination Current, VBAT1	-40°C to 85°C, 5V USB	10mA
Fast Charging Current, VBAT2	-40°C to 85°C, 4.5V Input	192mA
Charging Termination Current, VBAT2	-40°C to 85°C, 4.5V Input	2mA
USB Input Current Limit	-40°C to 85°C, 5V USB	1.1A
VBAT1=4.0V, VBAT2=3.6V	RLIM = 703 $\Omega$ ,	88.4%
VBAT1=4.0V, VBAT2=4.0V	RLIM = 703 $\Omega$ ,	86.4%
VBAT1=4.0V, VBAT2=4.2V	RLIM = 703 $\Omega$ ,	87.2%

To verify the charging efficiency, a 5-V constant boost output is used for comparison. The following test used this TI Design to charge an empty 600-mA·H Li-ion battery. The current from BAT1 is recorded and summed up to get the total power consumption to charge a fresh BAT2 battery. The results are summarized in [表 3](#).

**表 3. Power Consumption**

Battery BAT1 Voltage	Boost Output Adjustable		Boost Output Fixed at 5V	
	ILIM =134mA	ILIM=192mA	ILIM = 134mA	ILIM = 192mA
VBAT1 = 3.3V	2.77 W·H	2.83 W·H	3.40 W·H	3.34 W·H
VBAT1 = 3.6V	2.75 W·H	2.81 W·H	3.34 W·H	3.37 W·H
VBAT1 = 4.0V	2.70 W·H	2.77 W·H	3.36 W·H	3.37 W·H
VBAT1 = 4.2V	2.66 W·H	2.73 W·H	3.35 W·H	3.35 W·H

The charging efficiency is about 2% lower when the current limit of BQ25100A is set to 192 mA compared with that of 134 mA for an adjustable boost converter configuration. This is caused by the linear charger voltage drop. From [図 16](#) and [式 3](#), the voltage drop is only 150 mV if ILIM is set to 134 mA while it is 300 mV when ILIM set to 192 mA.

The charging efficiency is about 18% higher in the adjustable boost output configuration compared with the 5-V fixed output configuration when the BAT1 voltage is 4.2 V. This additional loss is still caused by the linear charger. For the boost output adjustable configuration, the TPS61099 is in pass-through mode most of the time and has a charging efficiency of 90.2%. However, for a 5-V fixed-boost output version, TPS61099 has to boost to 5 V first then the linear charger regulates it to the battery voltage that has an average voltage of 4-V. This leads to a charging efficiency of less than 72%.

### 6.2.1 Efficiency Curves

The DC charging efficiency test is performed by using a DC power supply as BAT1 and a source meter (work as constant voltage source) as BAT2. The results are shown in [Figure 13](#) and [Figure 14](#). In this two figures, the VIN represents the BAT1 voltage, and the VOUT represents the BAT2 voltage. This TI Design has a 92% charging efficiency when the BAT1 voltage is 4.2 V and BAT2 voltage is 4.0 V with a 134-mA current limit.

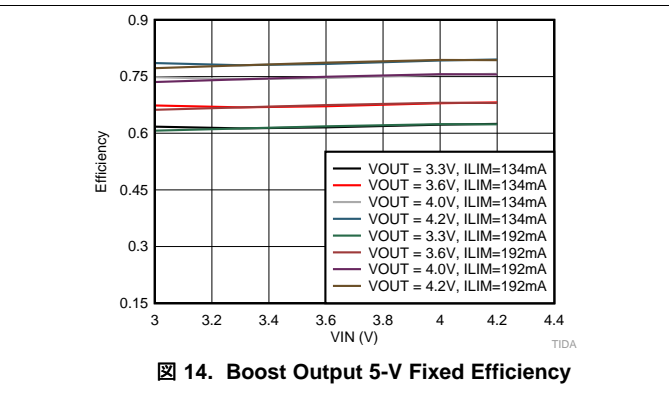
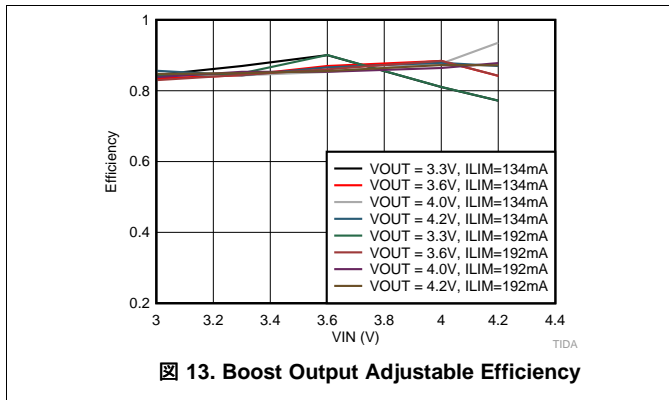

### 6.2.2 Voltage Tracking

The voltage tracking function is achieved as shown in [Figure 15](#) to [Figure 24](#).

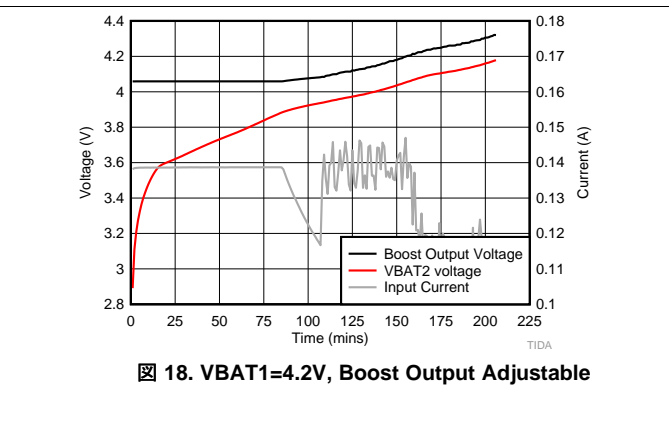
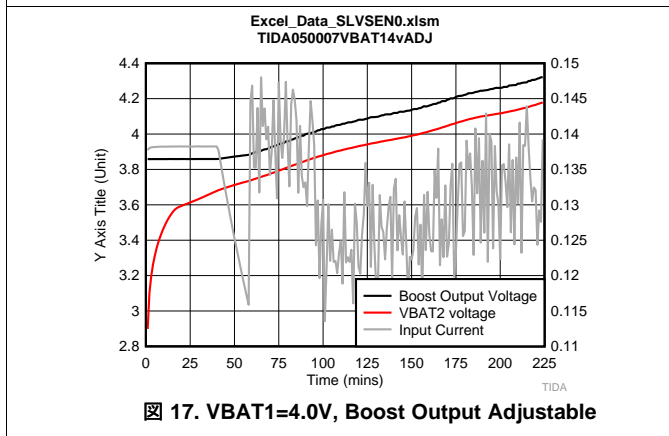
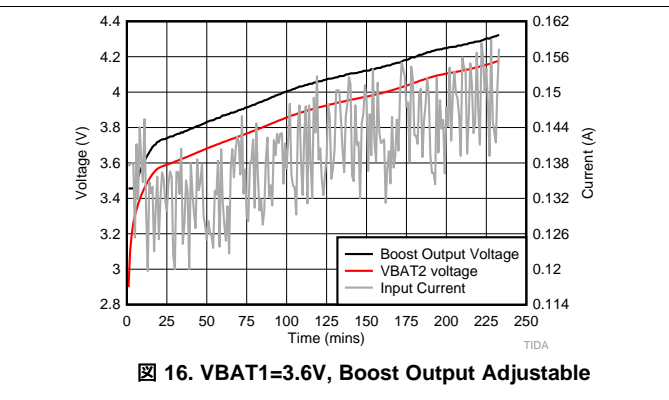
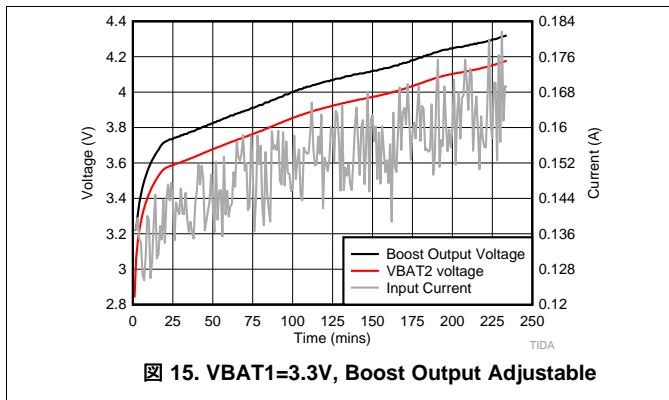

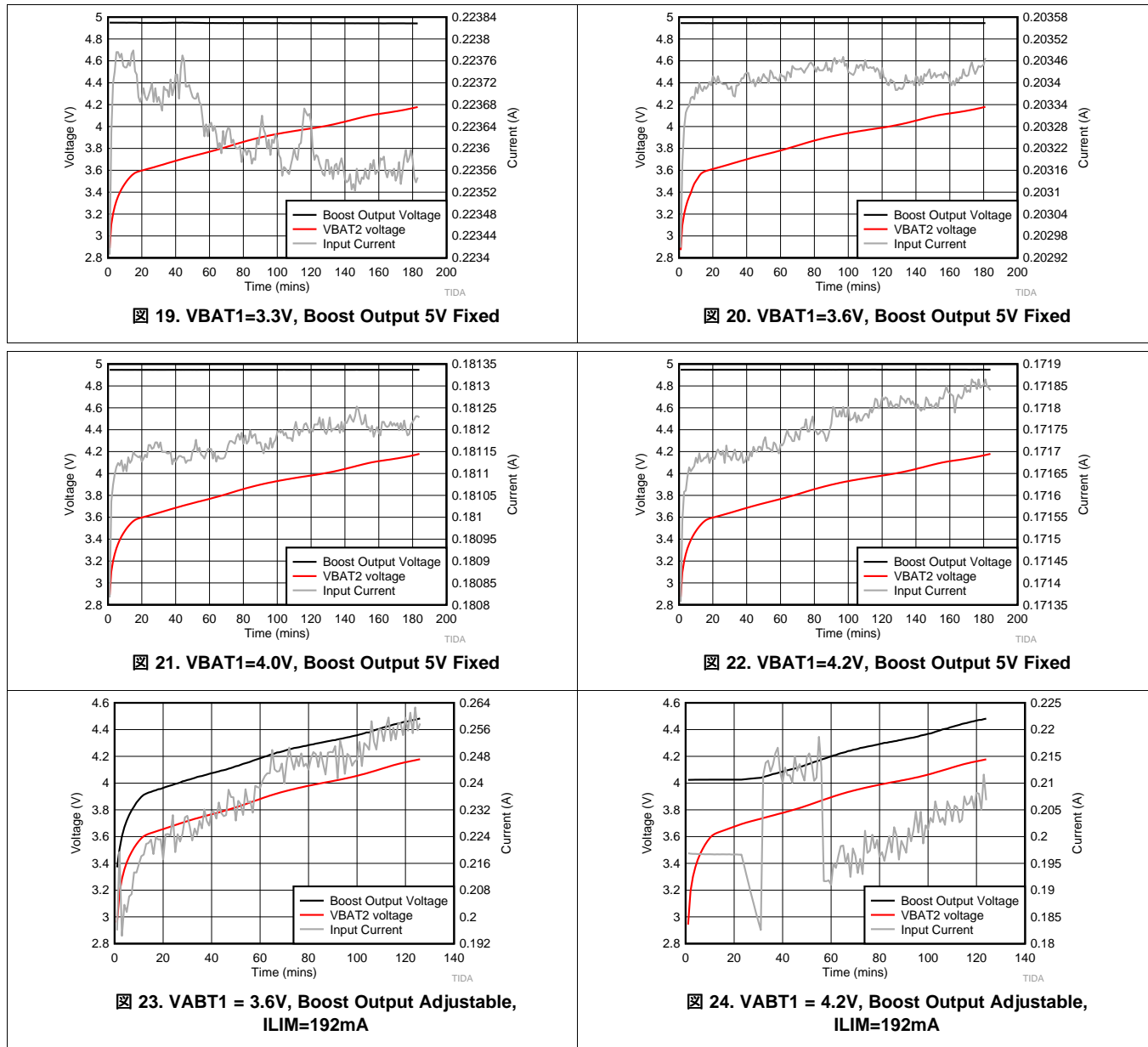

### 6.3 Test Results - Application Curves

#### 6.3.1 Voltage Tracking

This section shows the switching waveforms to check whether the system can enter and exit pass-through mode and boost mode normally. The BQ25100A current limit is set to 192 mA while the  $R_{SENSE}$  is set to  $0.315\Omega$ . The results are shown in [Figure 25](#) to [Figure 28](#).

The red line is the boost output voltage with a DC offset, the offset value is shown in each graph;

The blue line is the BAT2 voltage with a DC offset, this offset value is the same as the red line signal;

The green line is the charge current to BAT2

The pink line is the boost output current.



図 25. VBAT1=3.0V, Boost Output Regulation



図 26. VBAT1=3.6V, Boost Output Regulation

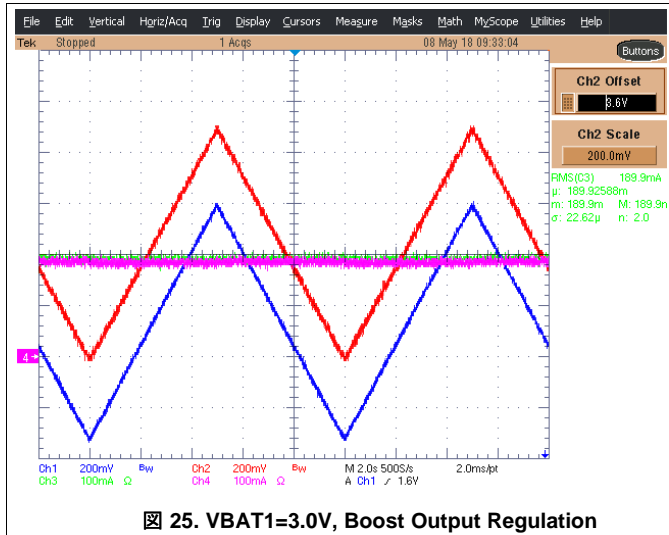

図 27. VBAT1=4.0V, Boost Output Regulation

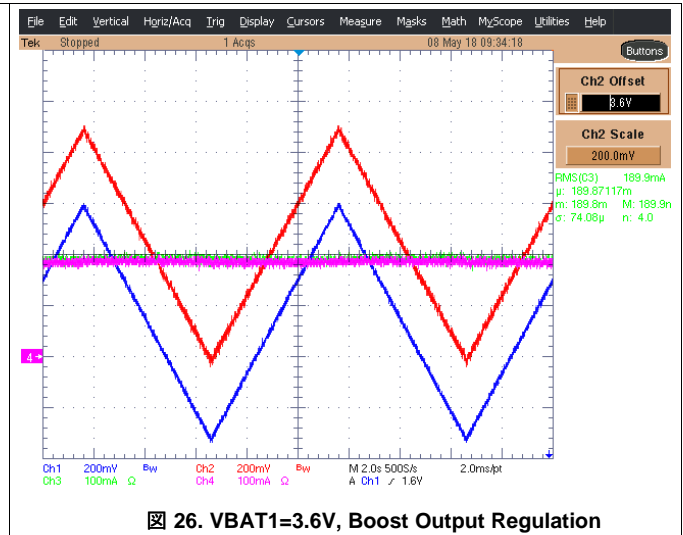

図 28. VBAT1=4.2V, Boost Output Regulation

### 6.3.2 Startup

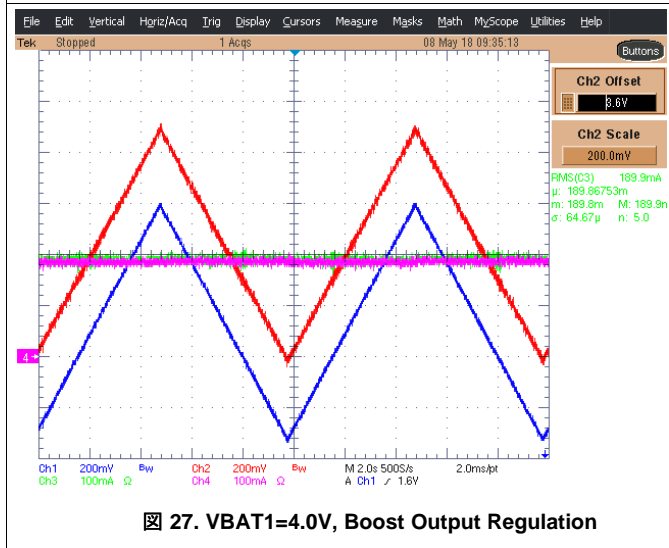
The blue line is the boost output voltage;

The red line is the BAT2 voltage to simulate the insertion of earbuds;

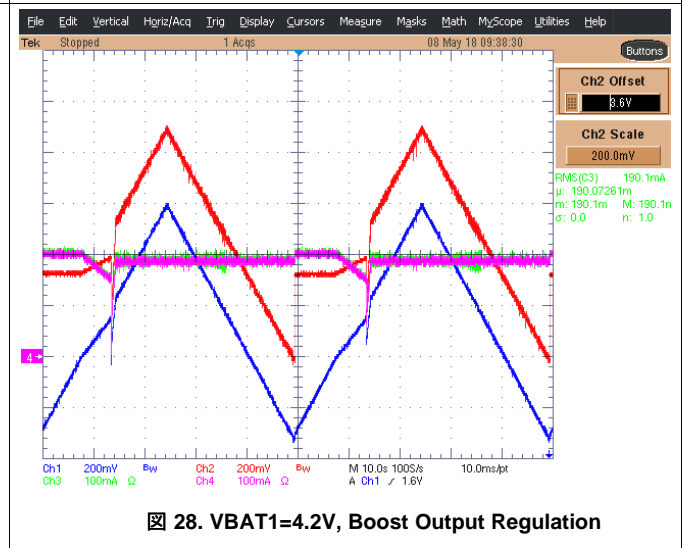
The green line is the charge current to the BAT2 battery;





図 29. VBAT1=3V6 VBAT2=4V0



図 30. VBAT1=4V0 VBAT2=3V6

From 図 29 and 図 30, this TI Design stays in ultra-low power mode and the boost output is 5 V. After a certain level waiting time (0-5s), this TI Design adjusts the boost output voltage to track the BAT2 voltage. Looking at 図 29, as the BAT2 voltage is much higher than the BAT1 voltage, the TPS61099 stays in pass-through mode in the beginning then the boost output voltage ramps up to higher than the BAT2 voltage. In 図 30, as the BAT2 voltage is much smaller than the BAT1 voltage, the TPS61099 stays in pass-through mode all the time.

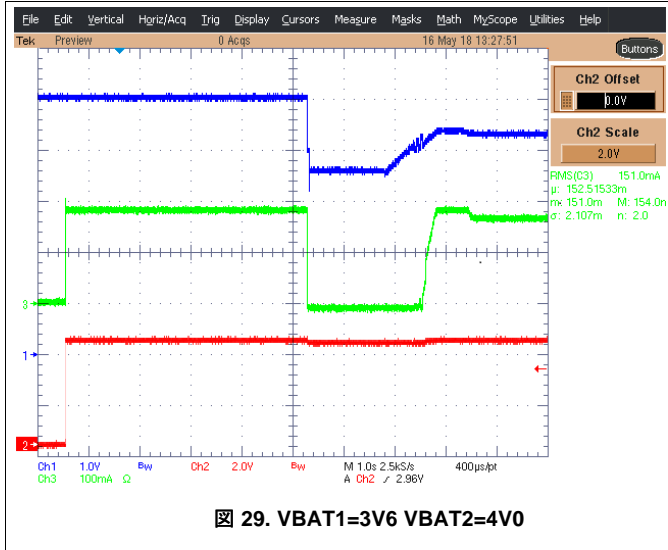
### 6.3.3 Switching

The blue line is the boost output voltage with a DC offset, this offset is shown in each graph;

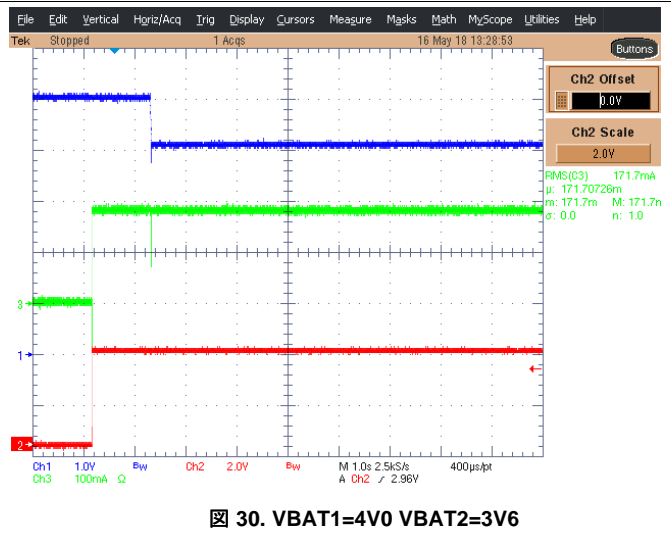
The red line the boost SW node voltage

The green line is the charge current to BAT2;



図 31. VBAT1=3.3V, VBAT2=3.3V, Boost Switching Waveform



図 32. VBAT1=3.3V, VBAT2=3.6V, Boost Switching Waveform

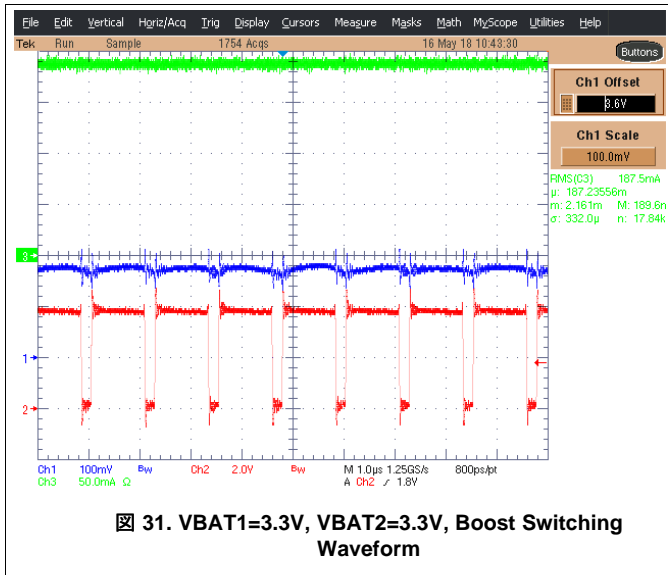

図 33. VBAT1=3.3V, VBAT2=4.0V, Boost Switching Waveform

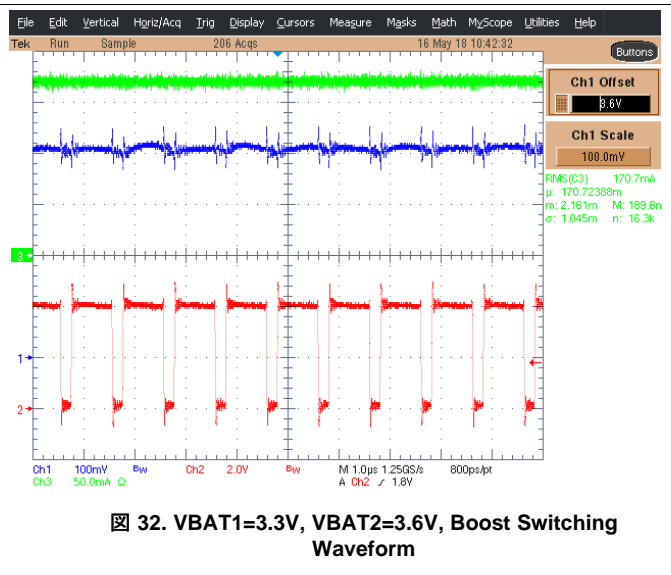

図 34. VBAT1=3.3V, VBAT2=4.2V, Boost Switching Waveform

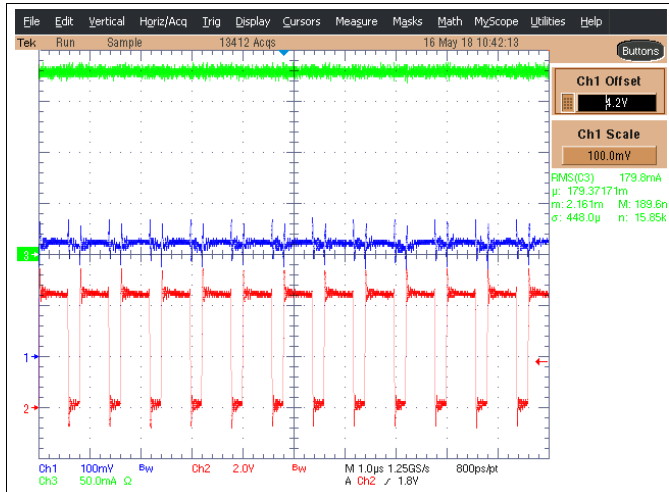

図 35. VBAT1=3.6V, VBAT2=3.3V, Boost Switching Waveform

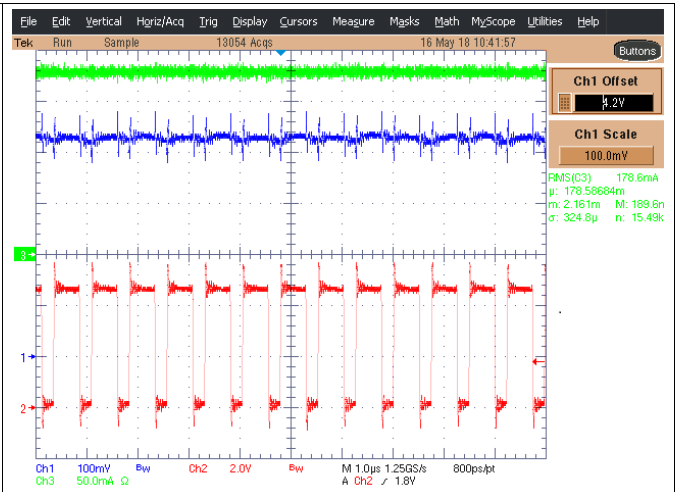

図 36. VBAT1=3.6V, VBAT2=3.6V, Boost Switching Waveform

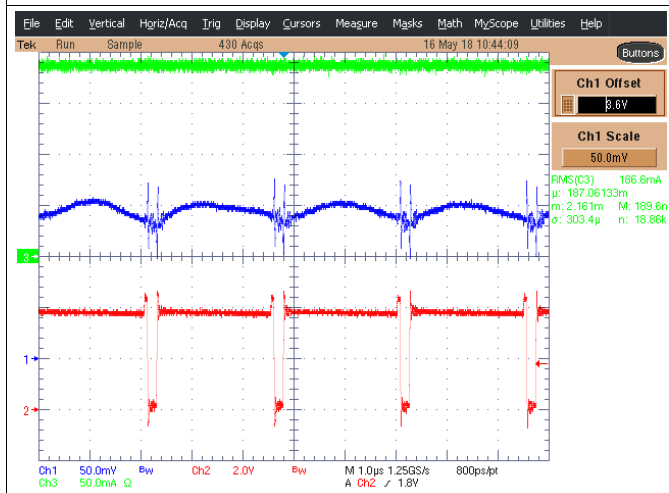

図 37. VBAT1=3.6V, VBAT2=4.0V, Boost Switching Waveform

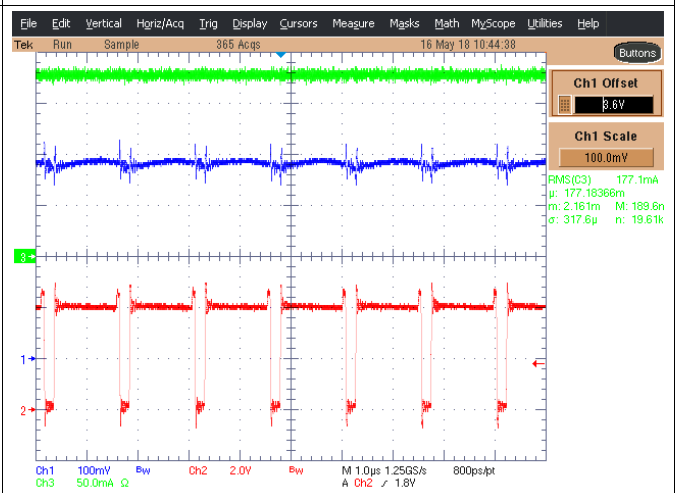

図 38. VBAT1=3.6V, VBAT2=4.2V, Boost Switching Waveform

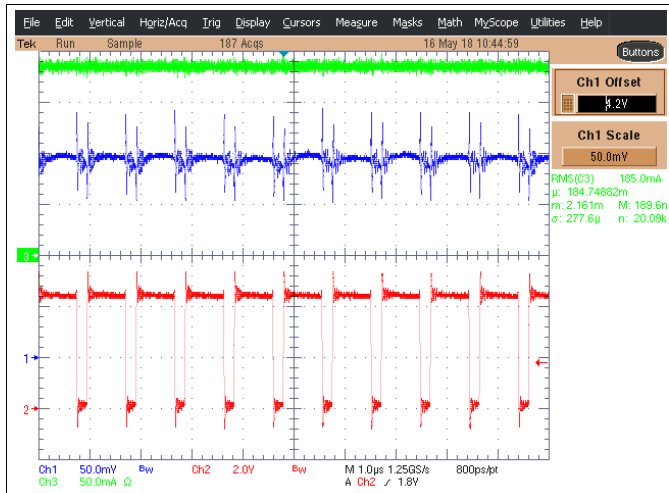

図 39. VBAT1=4.0V, VBAT2=3.3V, Boost Switching Waveform

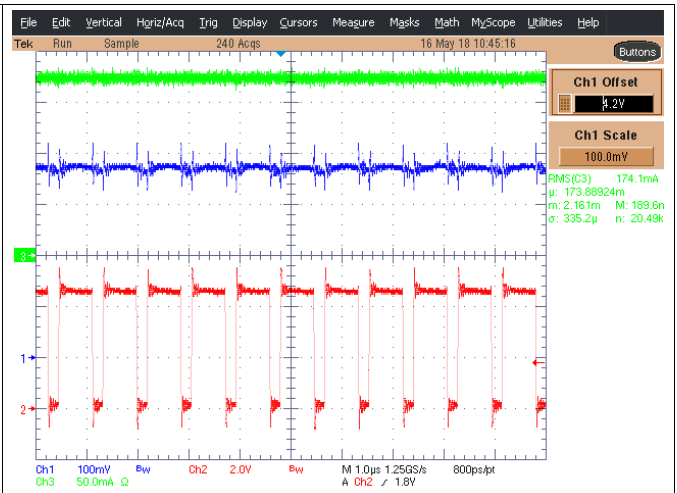

図 40. VBAT1=4.0V, VBAT2=3.6V, Boost Switching Waveform

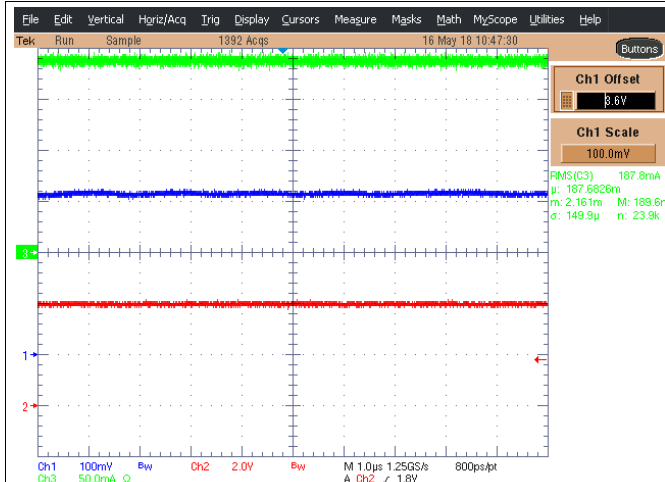

図 41. VBAT1=4.0V, VBAT2=4.0V, Boost Switching Waveform

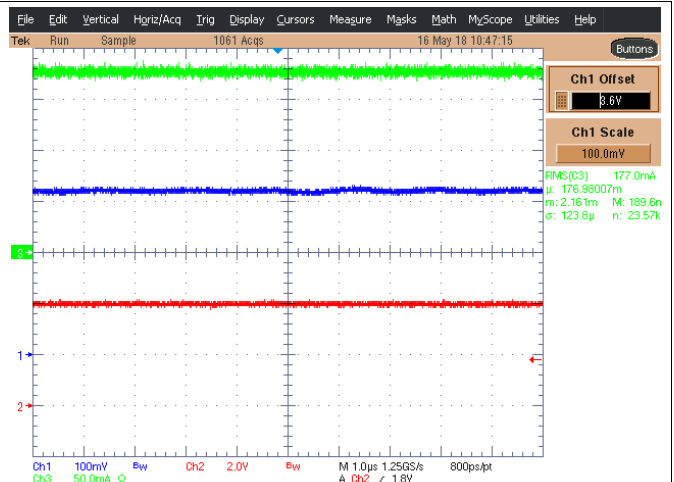

図 42. VBAT1=4.0V, VBAT2=4.2V, Boost Switching Waveform

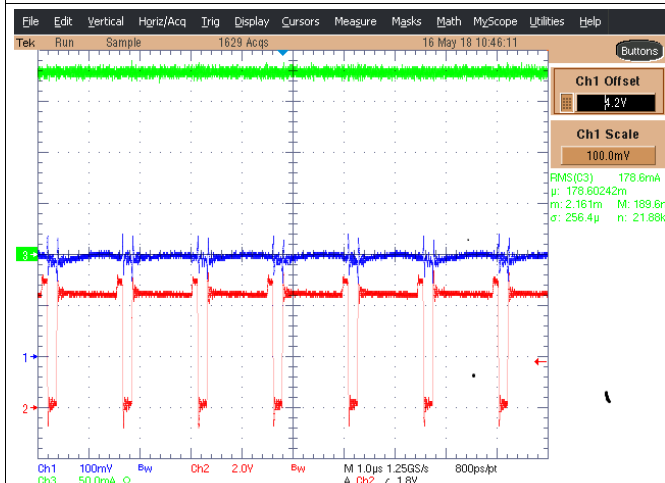

図 43. VBAT1=4.2V, VBAT2=3.3V, Boost Switching Waveform

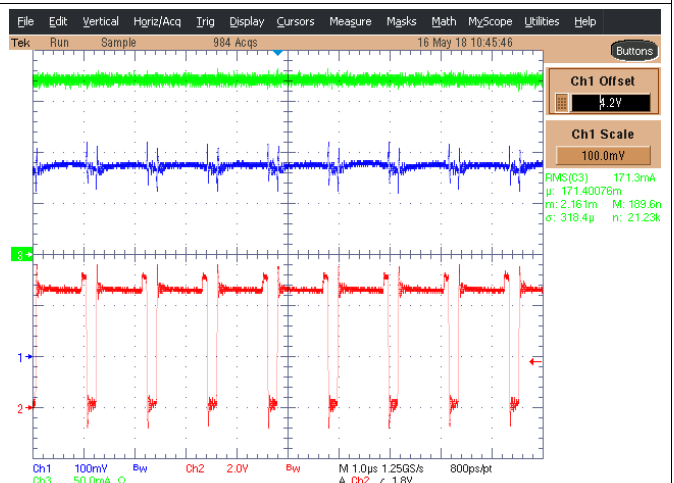

図 44. VBAT1=4.2V, VBAT2=3.6V, Boost Switching Waveform



図 45. VBAT1=4.2V, VBAT2=4.0V, Boost Switching Waveform



図 46. VBAT1=4.2V, VBAT2=4.2V, Boost Switching Waveform

### 6.4 Thermal Performance

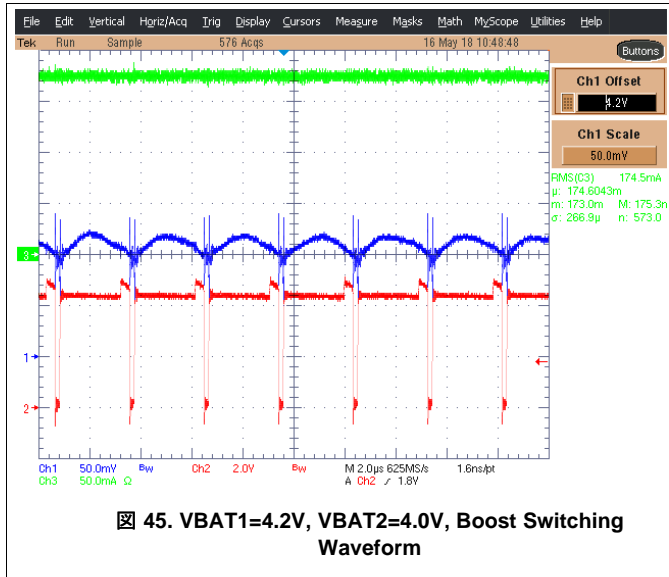
The thermal performance are evaluated as well under room temperature at 25°C.

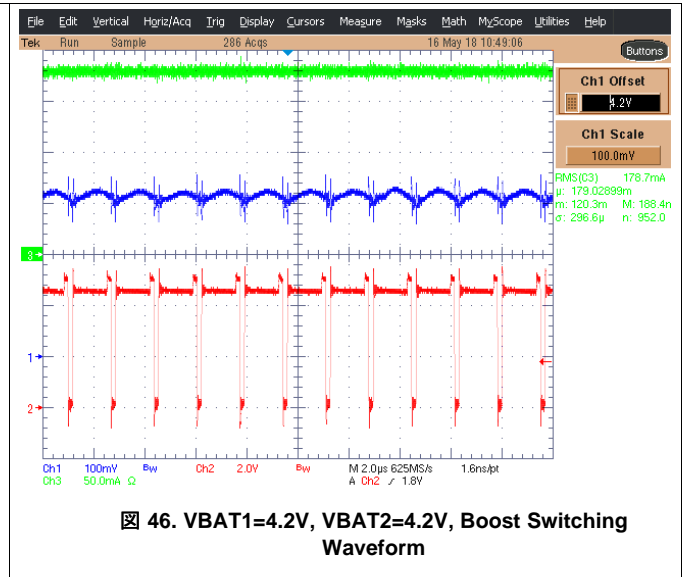

図 47. Boost Output Adjustable, USB plug in, VBAT2=3.3V



図 48. Boost Output Adjustable, USB plug in, VBAT2=4.0V



図 49. Boost 5-V Fixed Output, USB plug in, VBAT2=3.3V



図 50. Boost 5-V Fixed Output USB plug in, VBAT2=4.0V

The test setup shown above is to evaluate the thermal performance when a USB cable is plugged in. Under this condition, the worst case occurs when both BAT1 and BAT2 are needed to be charged. In this test, a 600-mA·h Li-ion battery with 3.6 V voltage is used as BAT1 and a source meter work as BAT2 by configuring the source meter to voltage source.

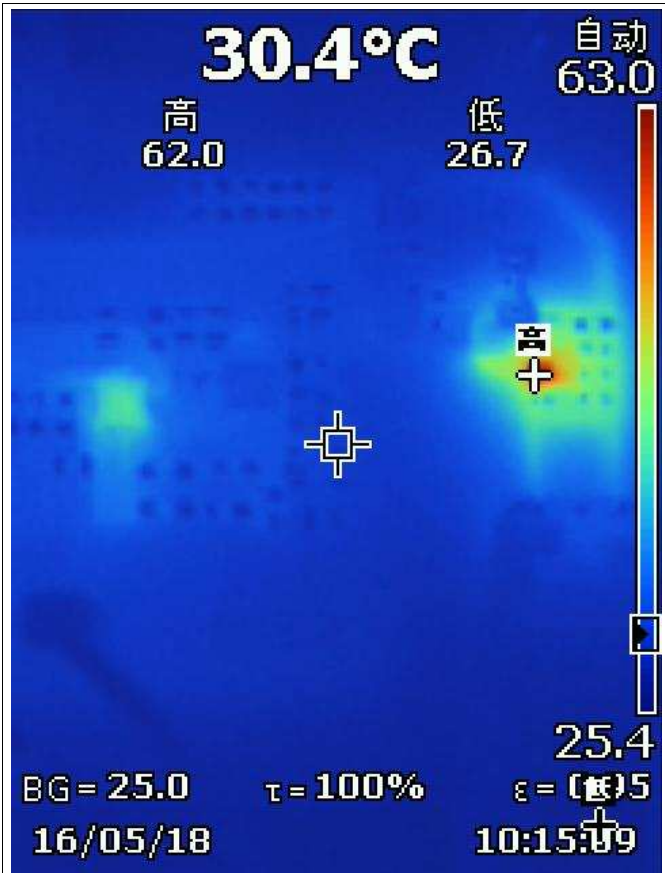
The BQ24073 has a constant 4.3 V at the OUT pin if an active USB cable is plugged in. In this Reference Design, the TPS61099 operates in pass-through mode. The hottest part is BQ24073 when BAT2 is set to 4.0 V. The BA25100A is hottest when BAT2 is set to 3.3 V. The root cause of this difference is the voltage drop is about 1 V when VBAT2 is 3.3 V leading to 0.2 W power loss while it is less than 0.06 W when VBAT2 is 4.0 V. The BQ24073 has almost the same temperature rise because the total current to supply BAT1 and BAT2 are the same. The temperature rise of BQ24073 is 15.9°C no matter if VBAT2 is set to 3.3 V or 4.0 V. However, BQ25100A will have 24.2°C temperature rise when VBAT2 is 3.3 V.

As a comparison, the boost is configured to a 5-V fixed output. The temperature is much higher because of higher voltage drop on BQ25100A. The temperature rise of BQ25100A is 28.6°C when VBAT2 is 4.0 V, and 38°C when VBAT2 is 3.3 V.

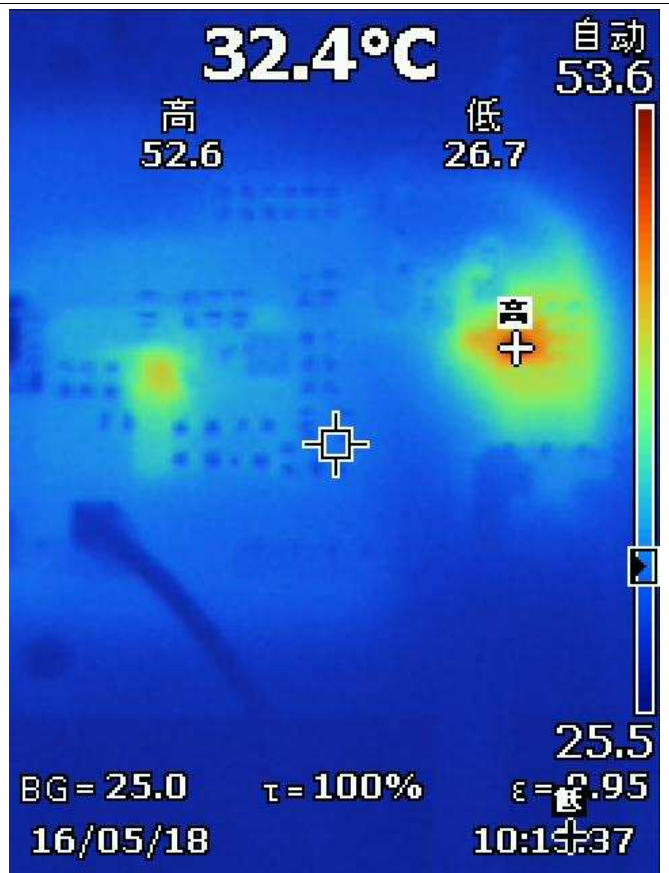
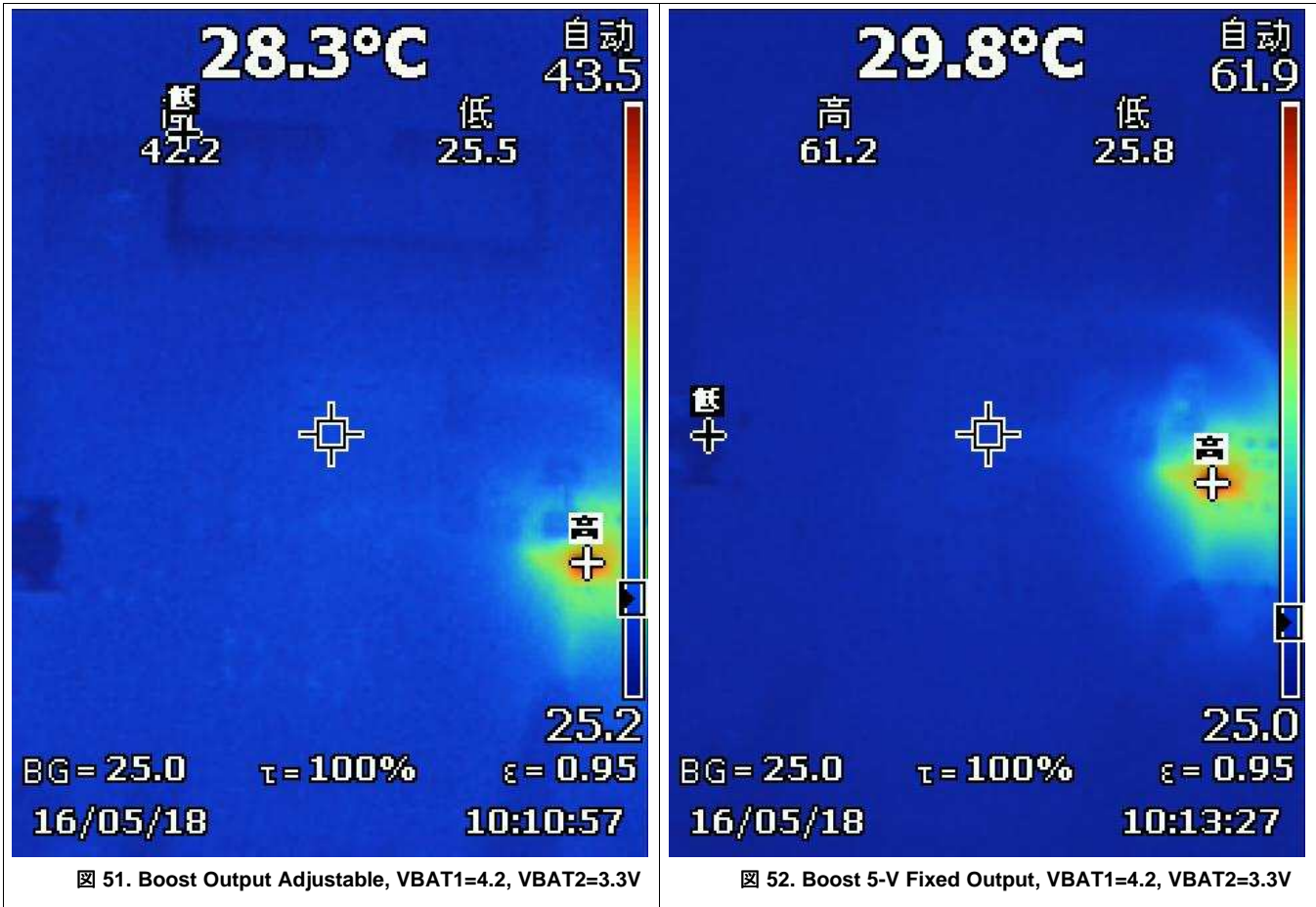

The test setup shown above is to evaluate the thermal performance when no USB cable is plugged in. In this test, a DC power supply is used as BAT1 and a source meter works as BAT2 by configuring the source meter to voltage source. The BAT1 is set to 4.2 V and BAT is set to 3.3 V. The temperature rises is 18.5°C for this reference design. As a comparison, the temperature rise is 37°C when the boost converter output is configured as 5-V fixed output.



図 53. Boost Output Adjustable, VBAT1=3.3, VBAT2=4.2V



図 54. Boost 5-V Fixed Output, VBAT1=3.3, VBAT2=4.2V

The test setup shown above is to evaluate the thermal performance when no USB cable is plugged in. In this test, a DC power supply is used as BAT1 and a source meter work as BAT2 by configuring the source meter to voltage source. The BAT1 is set to 3.3V and BAT2 is set to 4.2V. The temperature rises is 8.6°C for this reference design. As a comparison, the temperature rise is 38°C when the boost converter output is configured as 5-V fixed output.

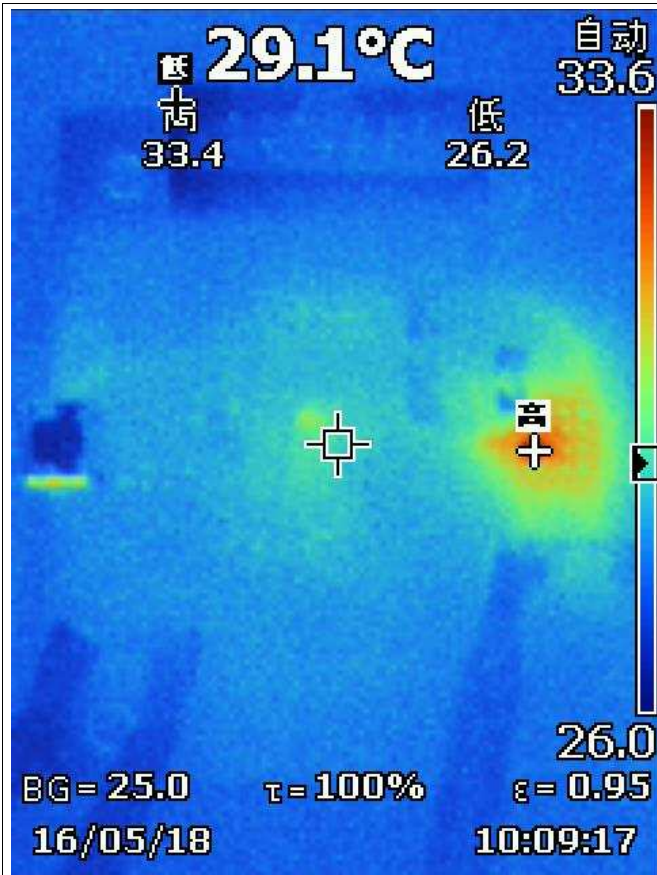
## 7 Design Files

### 7.1 Schematics

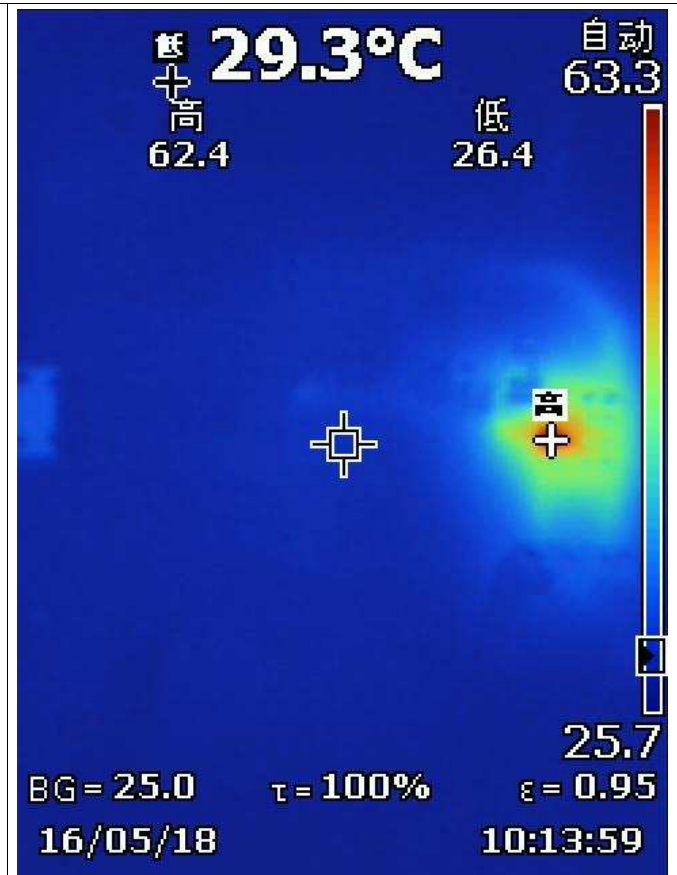
To download the schematics, see the design files at [TIDA-050007](#).

### 7.2 Bill of Materials

To download the bill of materials (BOM), see the design files at [TIDA-050007](#).

### 7.3 PCB Layout Recommendations

#### 7.3.1 Layout Prints

To download the layer plots, see the design files at [TIDA-050007](#).

### 7.4 Altium Project

To download the Altium Designer® project files, see the design files at [TIDA-050007](#).

### 7.5 Gerber Files

To download the Gerber files, see the design files at [TIDA-050007](#)

### 7.6 Assembly Drawings

To download the assembly drawings, see the design files at [TIDA-050007](#).

## 8 Software Files

To download the software files, see the design files at [TIDA-050007](#).

## 9 About the Author

**Charles Wong** is a system engineer at Texas Instruments where he is responsible for developing high performance synchronous boost converters in Boost Converter and Controller Solutions Group. Charles also is developing reference design and application notes for personal electronics, industrial and automotive applications since early 2014. Charles earned a Master and Bachelor degree in Analog and Mixed Signal IC design from Zhejiang University in 2014 and 2011 respectively.



## TIの設計情報およびリソースに関する重要な注意事項

Texas Instruments Incorporated ("TI")の技術、アプリケーションその他設計に関する助言、サービスまたは情報は、TI製品を組み込んだアプリケーションを開発する設計者に役立つことを目的として提供するものです。これにはリファレンス設計や、評価モジュールに関係する資料が含まれますが、これらに限られません。以下、これらを総称して「TIリソース」と呼びます。いかなる方法であっても、TIリソースのいずれかをダウンロード、アクセス、または使用した場合、お客様(個人、または会社を代表している場合にはお客様の会社)は、これらのリソースをここに記載された目的にのみ使用し、この注意事項の条項に従うことに合意したものとします。

TIによるTIリソースの提供は、TI製品に対する該当の発行済み保証事項または免責事項を拡張またはいかなる形でも変更するものではなく、これらのTIリソースを提供することによって、TIにはいかなる追加義務も責任も発生しないものとします。TIは、自社のTIリソースに訂正、拡張、改良、およびその他の変更を加える権利を留保します。

お客様は、自らのアプリケーションの設計において、ご自身が独自に分析、評価、判断を行う責任がお客様にあり、お客様のアプリケーション(および、お客様のアプリケーションに使用されるすべてのTI製品)の安全性、および該当するすべての規制、法、その他適用される要件への遵守を保証するすべての責任をお客様のみが負うことを理解し、合意するものとします。お客様は、自身のアプリケーションに関して、(1) 故障による危険な結果を予測し、(2) 障害とその結果を監視し、および、(3) 損害を引き起こす障害の可能性を減らし、適切な対策を行う目的での、安全策を開発し実装するために必要な、すべての技術を保持していることを表明するものとします。お客様は、TI製品を含むアプリケーションを使用または配布する前に、それらのアプリケーション、およびアプリケーションに使用されているTI製品の機能性を完全にテストすることに合意するものとします。TIは、特定のTIリソース用に発行されたドキュメントで明示的に記載されているもの以外のテストを実行していません。

お客様は、個別のTIリソースにつき、当該TIリソースに記載されているTI製品を含むアプリケーションの開発に関連する目的でのみ、使用、コピー、変更することが許可されています。明示的または黙示的を問わず、禁反言の法理その他どのような理由でも、他のTIの知的所有権に対するその他のライセンスは付与されません。また、TIまたは他のいかなる第三者のテクノロジーまたは知的所有権についても、いかなるライセンスも付与されるものではありません。付与されないものには、TI製品またはサービスが使用される組み合わせ、機械、プロセスに関連する特許権、著作権、回路配置利用権、その他の知的所有権が含まれますが、これらに限られません。第三者の製品やサービスに関する、またはそれらを参照する情報は、そのような製品またはサービスを利用するライセンスを構成するものではなく、それらに対する保証または推奨を意味するものでもありません。TIリソースを使用するため、第三者の特許または他の知的所有権に基づく第三者からのライセンス、もしくは、TIの特許または他の知的所有権に基づくTIからのライセンスが必要な場合があります。

TIのリソースは、それに含まれるあらゆる欠陥も含めて、「現状のまま」提供されます。TIは、TIリソースまたはその仕様に関して、明示的か暗黙的にかかわらず、他のいかなる保証または表明も行いません。これには、正確性または完全性、権原、続発性の障害に関する保証、および商品性、特定目的への適合性、第三者の知的所有権の非侵害に対する黙示的保証が含まれますが、これらに限られません。

TIは、いかなる苦情に対しても、お客様への弁済または補償を行う義務はなく、行わないものとします。これには、任意の製品の組み合わせに関連する、またはそれらに基づく侵害の請求も含まれますが、これらに限られず、またその事実についてTIリソースまたは他の場所に記載されているか否かを問わないものとします。いかなる場合も、TIリソースまたはその使用に関連して、またはそれらにより発生した、実際の、直接的、特別、付随的、間接的、懲罰的、偶発的、または、結果的な損害について、そのような損害の可能性についてTIが知らされていたかどうかにかかわらず、TIは責任を負わないものとします。

お客様は、この注意事項の条件および条項に従わなかったために発生した、いかなる損害、コスト、損失、責任からも、TIおよびその代表者を完全に免責するものとします。

この注意事項はTIリソースに適用されます。特定の種類の資料、TI製品、およびサービスの使用および購入については、追加条項が適用されます。これには、半導体製品(<http://www.ti.com/sc/docs/stdterms.htm>)、評価モジュール、およびサンプル(<http://www.ti.com/sc/docs/sampterms.htm>)についてのTIの標準条項が含まれますが、これらに限られません。