

## TI Designs: TIDA-01436

Sitara™PLSDKおよび3D ToFを使用した人数カウントによるデマ  
ンド制御換気機能のリファレンス・デザイン

## 概要

TIDA-01436デザインは、TIの3D ToFイメージ・センサと、追跡/検出アルゴリズムとを併用し、特定のエリアにいる人数を高分解能かつ高精度で計測するサブシステム・ソリューションです。このセンサ技術は標準のCMOSで開発されているため、低コストで非常に高度に統合されたシステムを実現できます。ToFイメージ・センサは視覚データを三次元で処理するため、人体の正確な形状を検出し、わずかな動きの変化も見逃すことなく、極めて高い精度で人の動きと位置を追跡できます。このTI Designは、組み込みソリューション用に理想的なTIのAM437xプロセッサをホスト・コントローラとして使用しています。これらの理由から、ホスト・コントローラ基板と組み合わせられたToFカメラは、従来の監視カメラやビデオ分析よりもはるかに効果的に、リアルタイムで人数のカウントや人々のトラッキング機能を実行可能です。

## リソース

<a href="#">TIDA-01436</a>	デザイン・フォルダ
<a href="#">OPT8241</a>	プロダクト・フォルダ
<a href="#">OPT9221</a>	プロダクト・フォルダ
<a href="#">AM437x</a>	プロダクト・フォルダ
<a href="#">OPT8241-CDK-EVM</a>	ツール・フォルダ
<a href="#">TMDSEVM437X</a>	ツール・フォルダ



[E2Eエキスパートに質問](#)

## 特長

- 90%を超える精度
- 応答時間を設定可能、リアルタイムまたは定期的に在室人数データを取得可能
- 広い視野角: H74.4°xV59.3°
- 周囲光に依存しないため、3D ToFカメラは暗闇でも動作可能
  - 自動照明
  - 4個のNIRレーザーで広い照明エリアを提供
  - 本質的に目に安全な、短い拡散レーザー・パルス
- CO2センサと異なり、局所的なCO2濃度の上昇、EMI、その他の汚染物質による性能への影響はない
- 組み込みプラットフォームで動作
  - TIのプロセッサ用Linuxソフトウェア開発キット(SDK)上で構築され、TIのAM437x GP EVMで実行
- 可動部品や定期的な較正が不要
- 完全に統合されたシステムによるエンド・ツー・エンドのソリューション

## アプリケーション

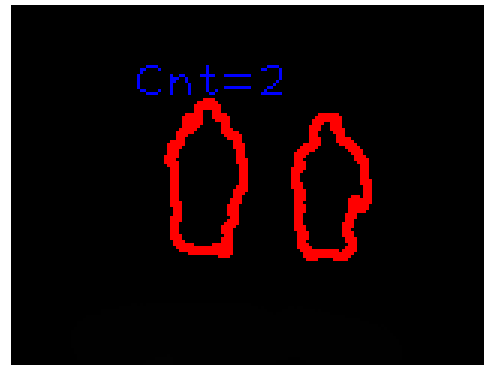
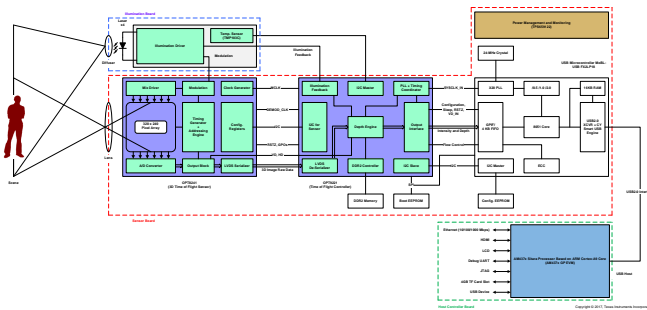
- HVAC: デマンド制御換気
- スマート・エレベータ
- マシン・ビジョン
- 物体検出
- ジェスチャ検出
- ロボティクス
- ビルの安全およびセキュリティ



使用許可、知的財産、その他免責事項は、最終ページにあるIMPORTANT NOTICE(重要な注意事項)をご参照くださいますようお願いいたします。英語版のTI製品についての情報を翻訳したこの資料は、製品の概要を確認する目的で便宜的に提供しているものです。該当する正式な英語版の最新情報は、[www.ti.com](http://www.ti.com)で閲覧でき、その内容が常に優先されます。TIでは翻訳の正確性および妥当性につきましては一切保証いたしません。実際の設計などの前には、必ず最新版の英語版をご参照くださいますようお願いいたします。

## 1 System Description

Locating and tracking groups of people in real time is hard to solve using conventional camera systems in many advanced applications. Tracking approaches can be primarily categorized based on types of devices deployed, whether they are monocular or stereoscopic camera systems. 2D tracking approaches suffer from occlusion and fail to handle close interactions. 3D tracking approaches based on stereoscopic camera have potential for dealing with some major tracking issues. However, the performance of most 3D stereo camera-based tracking systems start dropping quickly when the scene lacks texture due to either poor illumination or homogeneous objects.

Most commonly used are occupancy sensors based on passive infrared (PIR), which indicate only when the room is occupied or unoccupied; however, they cannot determine the number of people in a given area. For example, gas sensing techniques such as CO<sub>2</sub>-based occupancy detection sensors are subjected to accuracy issues over time and slow in detecting change of events, whereas large-scale deployment of conventional camera systems incurs substantial deployment costs and maintenance overhead. These sensors also bring up privacy issues as they detect more than what is required. What is missing is a precise, economical, compact, and universal imaging sensor that can capture the entire depth map (intensity and range information) of a scene at the same instance in just one image capture. Under all that, the new technology known as time of flight (ToF) 3D imaging technology appears to have significant advantages over traditional surveillance cameras and video analytics in several ways because surveillance cameras only record visual data in 2D, which limits the accuracy and potential sophistication of video analysis software. With additional information such as the distance to each point in the scene, the algorithmic challenges become more controllable.

This TI Design is a subsystem solution that relies on TI's high-performance 320×240 QVGA resolution 3D ToF image sensor combined with tracking and detection algorithms to count the number of occupants present in a given area. The camera sensor with ToF pixels allows 3D imaging with high resolution and accuracy. The sensor technology is developed in standard CMOS, allowing systems to achieve very high integration at low cost. Because ToF image sensor processes visual data in three dimensions, they can detect the exact shape of the human body and track the movement and location of people with exceptional precision, including subtle movement changes. For this reason, ToF cameras are potentially capable of performing real-time people counting and people tracking functions much more effectively than traditional surveillance cameras and video analytics.

The TIDA-01436 design can also be used for applications that require image processing. Object processing can be achieved using similar algorithms to the people counting algorithms described in this design guide. Gesture detection can similarly be done using the output of the ToF camera. These image processing techniques can be used as part of larger systems such as robotics, machine vision, smart elevators, and building safety and security. Building security is one area where the privacy offered by ToF sensing is a benefit, as only the number of people will be recorded. Smart elevators can make use of the people counting algorithms in a similar way to how this TI Design deals with demand controlled ventilation (DCV).

This reference design measures occupancy directly (as opposed to the previous inferred methods) and provides a reliable and accurate signal of occupancy levels to the ventilation control system, allowing the ventilation to be adapted instantly based on the fluctuating demand. This helps to optimize the indoor air quality (IAQ), ensure comfort, save energy and energy cost. For privacy sensitive applications, 3D ToF technology provides fast, accurate depth information without the use of higher resolution cameras infringing on privacy. This reference design system is a complete solution that combines a 3D ToF imaging sensor, onboard algorithms, and software, greatly simplifying development of standalone products and integration into existing customer systems.

This reference design subsystem is highly differentiated over existing solutions by offering the following benefits:

- People counting accuracy greater than 90%
- Low latency—occupancy data available in real time
- Wide field of view: H74.4° × V59.3°
- Being independent of ambient light conditions, texture and shadows, 3D ToF sensors can see in the dark
  - Auto-illumination
  - Four NIR lasers provide large illumination area
  - Short diffused laser pulses inherently safe to eyes
- Unlike CO2 sensors, performance not affected by localized elevated CO2 concentration or presence of any other pollutants
- Runs on versatile embedded platform
- Acquisition of the intensity and range data in each pixel at video rates without high computational cost and any moving components as well as the monocular setup.
- No periodic calibration
- 3D ToF based approach requires no computation for 3D scene reconstruction
- Easy integration and use
- Hardware can be easily upgraded with optional support for wireless interfaces like Sub 1-GHz Radio, Wi-Fi®, Zigbee®, and *Bluetooth*®
- Active sensor measuring travel time of near infrared light does not interfere with the scene in visible spectrum
- Standard CMOS chip reduces manufacturing cost and makes development of compact embedded solution easy

This reference design system uses the OPT8241-CDK-EVM and the AM437x GP Evaluation Module (EVM), both from Texas Instruments, to demonstrate people counting using 3D ToF camera. This reference design provides a complete set of downloadable documents such as a design guide, schematics, layout files, bill of materials (BOM), test results, and firmware that helps system designers in the design and development of their end-equipment systems.

## 1.1 Key System Specifications

表 1. Key System Specifications

PARAMETER	SPECIFICATION
People counting accuracy	Greater than 90%
ToF sensor	OPT8241
ToF controller	OPT9221
Sensor resolution	320 x 240 (QVGA) array of ToF pixels
Field of view	87° (Diagonal); 74.4° (Horizontal) x 59.3° (Vertical)
Frame rate	30 frames per seconds
Illumination source type	Modulated short diffused LASER pulses (Laser part number: 22045498 from LUMENTUM)
Number of illumination sources	04 LASERs
Illumination source centroid wavelength	855 nm
Modulation frequency	Up to 100-MHz pulsed operation (software configurable)
Average optical output power	1.5 W
Overall power consumption	< 10 W
Operating range	Up to 4 m
Operating temperature	0°C to 40°C (Ambient)
External power supply requirement	Nominal output voltage: 5-V DC Maximum output current: 3 A
Embedded platform	AM437x Sitara Processor based on ARM® Cortex®-A9 Core (AM437x GP EVM)

## 2 System Overview

### 2.1 Block Diagram

Along with TI's OPT9221 ToF controller, the OPT8241 ToF sensor forms a two-chip solution for creating a standalone 3D camera. The block diagram of a complete 3D ToF camera system implementation is shown in [Figure 1](#).

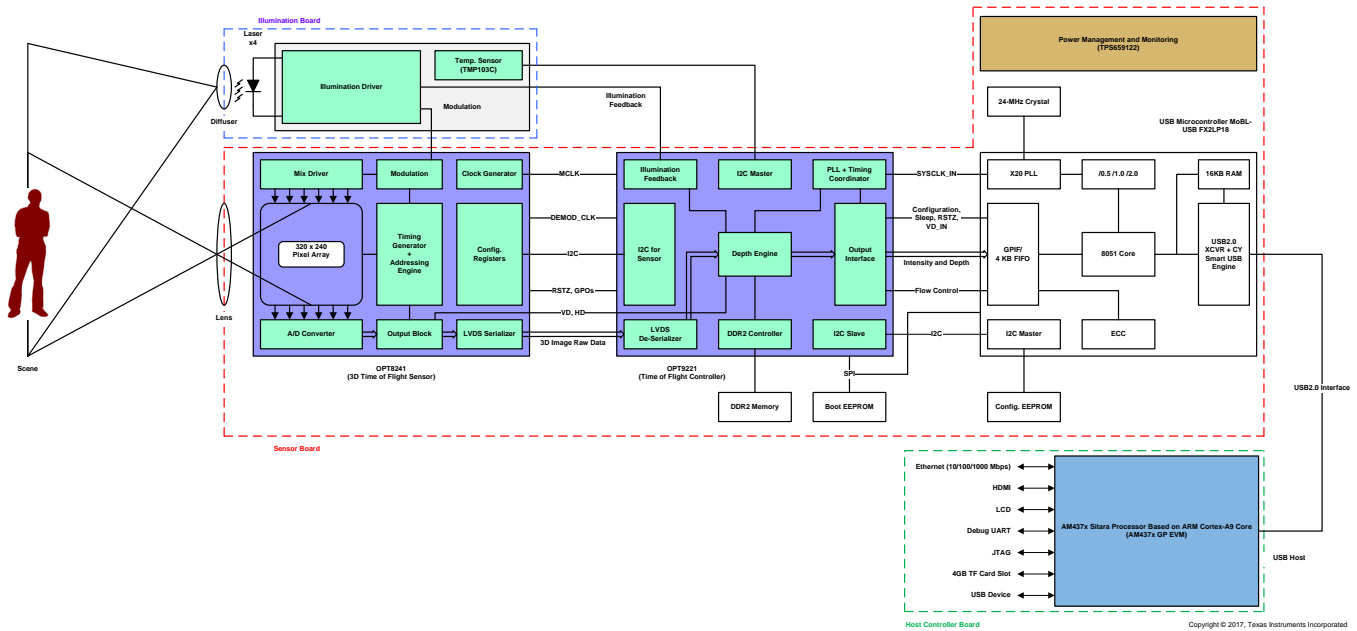

**Figure 1. Block Diagram of TIDA-01436**

The reference design system mainly consists of two main components:

1. OPT8241-CDK-EVM: Illumination board stacked on top of the sensor board
2. Host controller board: AM437x GP EVM (AM437x Sitara Processor Based on ARM Cortex-A9 Core).

The 3D ToF camera system is based on the well-known phase measuring optical ToF principle. The core of the camera system is based on the two chipsets OPT8241 and OPT9221. The OPT8241 ToF sensor provides the modulation signal with a few tens of MHz for the internal pixel array as well as for the external illumination circuitry. A modulated near-infrared (NIR) light is emitted through laser diodes from the illumination board. The objects that are located in the field of view reflect light that is projected through the lens onto the OPT8241 depth sensor IC. The phase shift between the light emitted by the source and the light reflected by the objects in the field of view obtained by the OPT8241 sensor is digitized and provided to the OPT9221 ToF Controller (TFC). The TFC then processes and provides the distance output for each pixel. The OPT8241-CDK-EVM located in back top corner of the room uses a Cypress FX2 chip as a USB transceiver that enables the host controller board to acquire data and to control the configuration of the CDK dynamically over USB2.0 interface. The host controller re-constructs the real-time topographic image of the scene by means of 3D information (intensity and data) and sophisticated embedded algorithms, which is then further processed to detect the number of people in a given area.

The principle of operation is described in more detail in *Time-of-Flight Camera — An Introduction* ([SLOA190](#)) and *Introduction to the Time-of-Flight (ToF) System Design* ([SBAU219](#)).

## 2.2 Highlighted Products

The TIDA-01436 design features the following devices:

- OPT8241: ToF Sensor
- OPT9221: TFC
- AM437x: Sitara processors based on ARM Cortex-A9 core

For more information on each of these devices, see their respective product folders at [www.TI.com](http://www.TI.com).

### 2.2.1 OPT8241

#### Features

- Imaging array:
  - 320x240 array
  - 1/3" optical format
  - Pixel pitch: 15  $\mu$ m
  - Up to 120 FPS
- Optical properties:
  - Responsivity: 0.35 A/W at 850 nm
  - Demodulation contrast: 45% at 50 MHz
  - Demodulation frequency: 10 to 100 MHz
- Output data format:
  - 12-bit phase correlation data
  - 4-bit common-mode (ambient)
- Chipset interface:
  - Compatible with TI's TFC [OPT9221](#)
- Sensor output interface:
  - CMOS data interface (50-MHz DDR, 16-lane data, clock, and frame markers)
  - LVDS:
    - 600 Mbps, 3 data pairs
    - 1-LVDS bit clock pair, 1-LVDS sample clock pair
- Timing generator (TG):
  - Addressing engine with programmable region of interest (ROI)
  - Modulation control
  - De-aliasing
  - Master, slave sync operation
- I<sup>2</sup>C slave interface for control
- Power supply:
  - 3.3-V I/O, analog
  - 1.8-V analog, digital, I/O
  - 1.5-V demodulation (typical)
- Optimized optical package (COG-78):
  - 8.757 mm x 7.859 mm x 0.700 mm
  - Integrated optical band-pass filter (830 nm to 867 nm)
  - Optical fiducials for easy alignment
- Operating temperature: 0°C to 70°C

#### Applications:

- Depth sensing:
  - Location and proximity sensing
  - 3D scanning
  - 3D machine vision
  - Security and surveillance
  - Gesture controls
  - Augmented and virtual reality
  - People counting

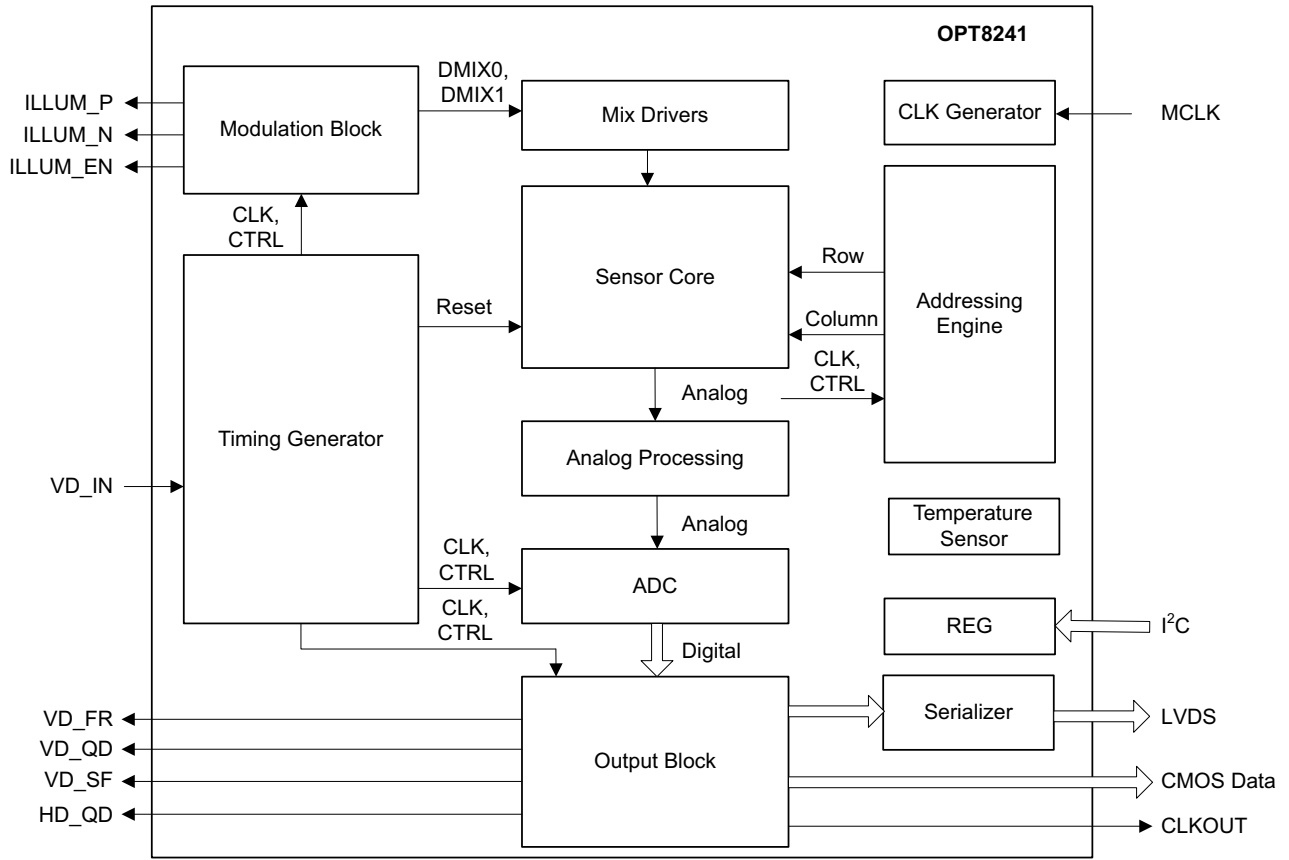

Copyright © 2016, Texas Instruments Incorporated

**図 2. OPT8241 Functional Block Diagram**

The OPT8241 ToF sensor is part of the TI 3D ToF image sensor family. The device combines ToF sensing with an optimally-designed ADC and a versatile, programmable TG. The device offers quarter video graphics array (QVGA 320×240) resolution data at frame rates up to 120 frames per second (480 readouts per second).

The built-in TG controls the reset, modulation, readout, and digitization sequence. The programmability of the TG offers flexibility to optimize for various depth-sensing performance metrics (such as power, motion robustness, signal-to-noise ratio, and ambient cancellation).



## 2.2.2 OPT9221

### Features:

- QVGA 3D TFC: Up to 120 FPS
- Depth data:
  - 12-bit phase
  - Up to 12-bit amplitude
  - Up to 4-bit ambient
  - Saturation detection
- Chipset interface:
  - Compatible with TI ToF sensor ([OPT8241](#))
- Output (CMOS, 8-lane data, 8 control signals, and clock):
  - Digital video protocol (DVP) compatible:
    - Data, VD, HD, clock
  - Synchronous serial interface (SSI) compatible
- Depth engine:
  - Pixel binning
  - ROI
  - De-aliasing
  - Nonlinearity correction
  - Temperature compensation
  - High dynamic range operation
  - Spatial filter
- Timing coordinator:
  - Sensor control
  - Master and slave sync operation
- I<sup>2</sup>C slave interface
- Power supply: 1.2-V core, 1.8-V I/O, 3.3-V I/O, 2.5-V analog
- Package: 256-pin, 9-mm×9-mm NFBGA
- Operating temperature: 0°C to 85°C

### Applications:

- 3D imaging:
  - Location and proximity sensing
  - 3D scanning and 3D machine vision
  - Security and surveillance
  - Gesture controls

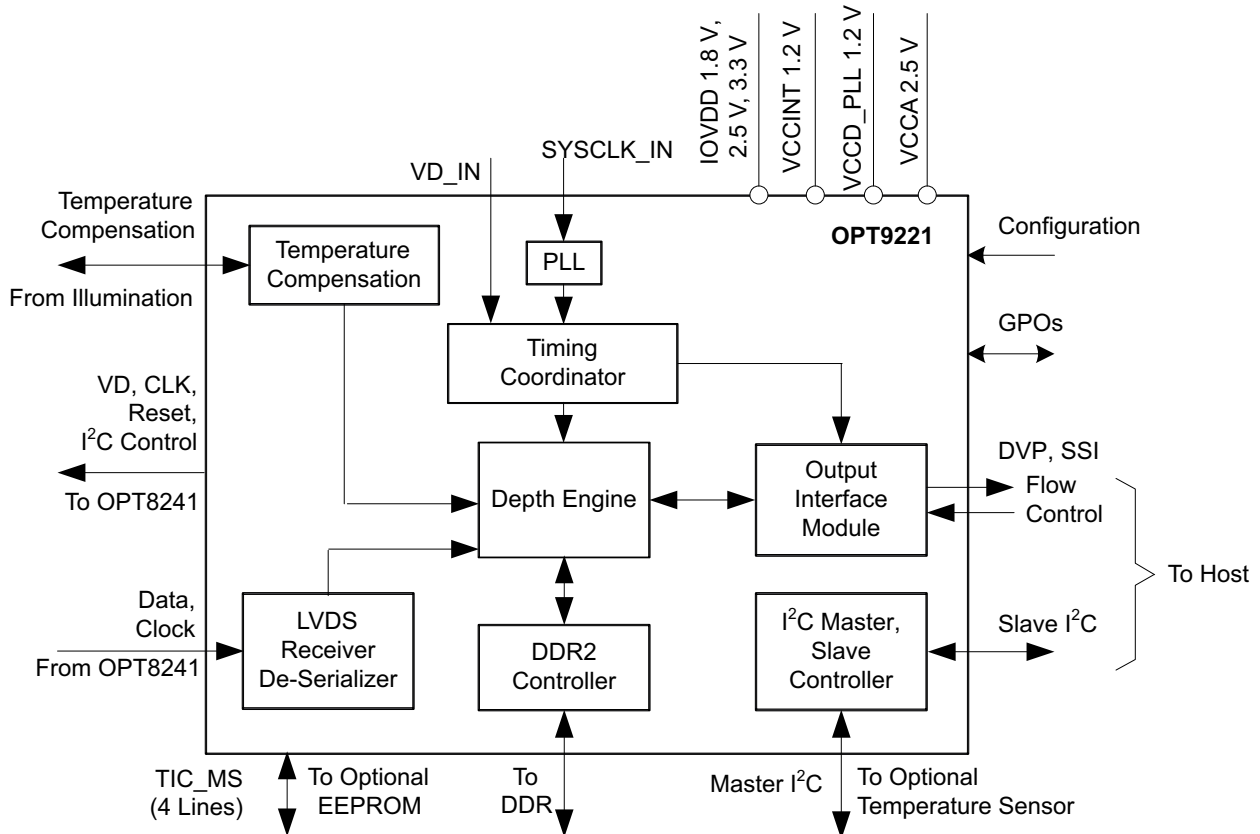

Copyright © 2016, Texas Instruments Incorporated

**図 3. OPT9221 Functional Block Diagram**

The TFC is a high-performance, 3D ToF sensor companion device that computes the depth data from the digitized sensor data. Depth data are output through a programmable CMOS parallel interface.

In addition to depth data, the TFC provides auxiliary information consisting of amplitude, ambient, and flags for each pixel. This information can be used to implement filters and masks and to dynamically control the system configuration for the intended performance.

The TFC supports a wide range of binning and ROI options that help optimize the data throughput that must be handled.

The 9-mm×9-mm NFBGA package enables small form-factor, 3D, ToF systems that can be embedded into a variety of end equipment.

### 2.2.3 AM437x

#### Features:

- Sitara ARM Cortex-A9 32-Bit RISC processor with processing speed up to 1000 MHz:
  - NEON™ SIMD coprocessor and vector floating point (VFPv3) coprocessor
  - 32KB of both L1 instruction and data cache
  - 256KB of L2 cache or L3 RAM
- 32-bit LPDDR2, DDR3, and DDR3L support
- General-purpose memory support (NAND, NOR, SRAM) up to 16-bit ECC
- SGX530 graphics engine
- Display subsystem
- Programmable real-time unit subsystem and industrial communication subsystem (PRU-ICSS)
- Real-time clock (RTC)
- Up to two USB 2.0 high-speed dual-role (host or device) ports with integrated PHY
- 10, 100, and 1000 Ethernet switch supporting up to two ports
- Serial interfaces:
  - Two controller area network (CAN) ports
  - Six UARTs, two McASPs, five McSPIs, three I<sup>2</sup>C ports, one QSPI, and one HDQ or 1-wire
  - Up to two ISO7816 (smart card) interfaces
- Security
  - Crypto hardware accelerators (AES, SHA, RNG, DES, and 3DES)
  - Secure boot
- Two 12-bit successive approximation register (SAR) ADCs
- Up to three 32-bit enhanced capture modules (eCAPs)
- Up to three enhanced quadrature encoder pulse modules (eQEPs)
- Up to six enhanced high-resolution PWM modules (eHRPWMs)
- MPU subsystem
  - ARM Cortex-A9 32-bit RISC MPU with processing speed up to 1000 MHz
  - 32KB of both L1 instruction and data cache
  - 256KB of L2 cache (option to configure as L3 RAM)
  - 256KB of on-chip boot ROM
  - 64KB of on-chip RAM
  - Secure control module (SCM)
  - Emulation and debug
    - JTAG
    - Embedded trace buffer
  - Interrupt controller
- On-chip memory (shared L3 RAM)
  - 256KB of general-purpose on-chip memory controller (OCMC) RAM
  - Accessible to all masters
  - Supports retention for fast wakeup
  - Up to 512KB of total internal RAM (256KB of ARM memory configured as L3 RAM + 256KB of OCMC RAM)
- External memory interfaces (EMIFs)
  - DDR controllers:
    - LPDDR2: 266-MHz clock (LPDDR2-533 data rate)
    - DDR3 and DDR3L: 400-MHz clock (DDR-800 data rate)
    - 32-bit data bus
    - 2GB of total addressable space
    - Supports one x32, two x16, or four x8 memory device configurations
- GPMC
  - Flexible 8- and 16-bit asynchronous memory interface with up to seven chip selects (NAND, NOR, Muxed-NOR, and SRAM)
  - Uses BCH code to support 4-, 8-, or 16-

- bit ECC
    - Uses hamming code to support 1-bit ECC
- Error locator module (ELM)
  - Used with the GPMC to locate addresses of data errors from syndrome polynomials generated using a BCH algorithm
  - Supports 4-, 8-, and 16-bit per 512-byte block error location based on BCH algorithms
- PRU-ICSS
  - Supports protocols such as EtherCAT®, PROFIBUS®, PROFINET®, EtherNet/IP™, EnDat 2.2, and more
  - Two programmable real-time unit (PRU) subsystems with two PRU cores each:
    - Each core is a 32-bit load and stores an RISC processor capable of running at 200 MHz
    - 12KB (PRU-ICSS1), 4KB (PRU-ICSS0) of instruction RAM with single-error detection (parity)
    - 8KB (PRU-ICSS1), 4KB (PRU-ICSS0) of data RAM With single-error detection (parity)
    - Single-cycle 32-bit multiplier with 64-bit accumulator
    - Enhanced GPIO module provides shift-in and shift-out support and parallel latch on external signal
  - 12KB (PRU-ICSS1 only) of shared RAM with single-error detection (parity)
  - Three 120-byte register banks accessible by each PRU
  - Interrupt controller module (INTC) for handling system input events
  - Local interconnect bus for connecting internal and external masters to the resources inside the PRU-ICSS
  - Peripherals inside the PRU-ICSS
    - One UART port with flow control pins,
- supports up to 12 Mbps
  - One eCAP module
  - Two MII ethernet ports that support industrial Ethernet, such as EtherCAT
  - One MDIO port
  - Industrial communication is supported by two PRU-ICSS subsystems
- Power reset and clock management (PRCM) module
  - Controls the entry and exit of deep-sleep modes
  - Responsible for sleep sequencing, power domain switch-off sequencing, wake-up sequencing, and power domain switch-on sequencing
  - Clocks
    - Integrated high-frequency oscillator used to generate a reference clock (19.2, 24, 25, and 26 MHz) for various system and peripheral clocks
    - Supports individual clock enable and disable control for subsystems and peripherals to facilitate reduced power consumption
    - Five ADPLLs to generate system clocks (MPU subsystem, DDR interface, USB, and peripherals [MMC and SD, UART, SPI, I<sup>2</sup>C], L3, L4, Ethernet, GFX [SGX530], and LCD pixel clock)
  - Power
    - Two nonswitchable power domains (RTC and wake-up logic [WAKE-UP])
    - Three switchable power domains (MPU subsystem, SGX530 [GFX], peripherals and infrastructure [PER])
    - Dynamic voltage frequency scaling (DVFS)
- RTC
  - Real-time date (day, month, year, and day of week) and time (hours, minutes, and seconds) information

- Internal 32.768-kHz oscillator, RTC logic, and 1.1-V internal LDO
- Independent power-on-reset (RTC\_PWRONRSTn) input
- Dedicated input pin (RTC\_WAKEUP) for external wake events
- Programmable alarm can generate internal interrupts to the PRCM for wakeup or Cortex-A9 for event notification
- Programmable alarm can be used with external output (RTC\_PMIC\_EN) to enable the power-management IC to restore non-RTC power domains
- Peripherals
  - Up to two USB 2.0 high-speed dual-role (host or device) ports with integrated PHY
  - Up to two industrial gigabit Ethernet MACs (10, 100, and 1000 Mbps)
    - Integrated switch
    - Each MAC supports MII, RMII, and RGMII and MDIO interfaces
    - Ethernet MACs and switch can operate independent of other functions
    - IEEE 1588v2 Precision Time Protocol (PTP)
  - Up to two CAN ports
    - Supports CAN v2 parts A and B
  - Up to two multichannel audio serial ports (McASPs)
    - Transmit and receive clocks up to 50 MHz
    - Up to four serial data pins per McASP port with independent TX and RX clocks
    - Supports time division multiplexing (TDM), inter-IC sound (I2S), and similar formats
    - Supports digital audio interface transmission (SPDIF, IEC60958-1, and AES-3 formats)
  - FIFO buffers for transmit and receive (256 bytes)
  - Up to six UARTs
    - All UARTs support IrDA and CIR modes
    - All UARTs support RTS and CTS flow control
    - UART1 supports full modem control
  - Up to five master and slave McSPI serial interfaces
    - McSPI0-McSPI2 supports up to four chip selects
    - McSPI3-McSPI4 supports up to two chip selects
    - Up to 48 MHz
  - One quad-SPI
    - Supports eExecute in place (XIP) from serial NOR FLASH
  - One Dallas 1-Wire® and HDQ serial interface
  - Up to three MMC, SD, and SDIO ports
    - 1-, 4-, and 8-bit MMC, SD, and SDIO modes
    - 1.8- or 3.3-V operation on all ports
    - Up to 48-MHz clock
    - Supports card detect and write protect
    - Complies with MMC4.3 and SD and SDIO 2.0 specifications
  - Up to three I<sup>2</sup>C master and slave interfaces
    - Standard mode (up to 100 kHz)
    - Fast mode (up to 400 kHz)
  - Up to six banks of general-purpose I/O (GPIO):
    - 32 GPIOs per bank (multiplexed with other functional pins)
    - GPIOs can be used as interrupt inputs (up to two interrupt inputs per

- bank)
  - Up to three external DMA event inputs that can also be used as interrupt inputs
  - Twelve 32-bit general-purpose timers:
    - DMTIMER1 is a 1-ms timer used for operating system (OS) ticks
    - DMTIMER4 to DMTIMER7 are pinned out
  - One public watchdog timer
  - One free-running, high-resolution 32-kHz counter (synctimer32K)
  - SGX530 3D graphics engine:
    - Tile-based architecture delivering up to 20M poly/sec
    - Universal scalable shader engine is a multithreaded engine incorporating pixel and vertex shader functionality
    - Advanced shader feature set in excess of Microsoft® VS3.0, PS3.0, and OGL2.0
    - Industry standard API support of Direct3D mobile, OGL-ES 1.1 and 2.0, and OpenVG 1.0
    - Fine-grained task switching, load balancing, and power management
    - Advanced geometry DMA-driven operation for minimum CPU interaction
    - Programmable high-quality image anti-aliasing
    - Fully virtualized memory addressing for OS operation in a unified memory architecture
  - Display subsystem
    - Display modes
      - Programmable pixel memory formats (palletized: 1, 2, 4, and 8 bits per pixel; RGB 16 and 24 bits per pixel; and YUV 4:2:2)
      - 256x24-bit entries palette in RGB
      - Up to 2048x2048 resolution
    - Display support
      - Four types of displays are supported: Passive and active colors; passive and active monochromes
      - 4- and 8-bit monochrome passive panel interface support (15 grayscale levels supported using dithering block)
      - RGB 8-bit color passive panel interface support (3,375 colors supported for color panel using dithering block)
      - RGB 12-, 16-, 18-, and 24-bit active panel interface support (replicated or dithered encoded pixel values)
      - Remote frame buffer (embedded in the LCD panel) support through the RFBI module
      - Partial refresh of the remote frame buffer through the RFBI module
      - Partial display
      - Multiple cycles output format on 8-, 9-, 12-, and 16-bit interface (TDM)
    - Signal processing
      - Overlay and windowing support for one graphics layer (RGB or CLUT) and two video layers (YUV 4:2:2, RGB16, and RGB24)
      - RGB 24-bit support on the display interface, optionally dithered to RGB 18-bit pixel output plus 6-bit frame rate control (spatial and temporal)
      - Transparency color key (source and destination)
      - Synchronized buffer update
      - Gamma curve support
      - Multiple-buffer support
      - Cropping support
      - Color phase rotation

- Two 12-bit SAR ADCs (ADC0, ADC1)
    - 867K samples per second
    - Input can be selected from any of the eight analog inputs multiplexed through an 8:1 analog switch
    - ADC0 can be configured to operate as a 4-, 5-, or 8-wire resistive touch screen controller (TSC)
  - Up to three 32-bit eCAP modules
    - Configurable as three capture inputs or three auxiliary PWM outputs
  - Up to six enhanced eHRPWM modules
    - Dedicated 16-bit time-base counter with time and frequency controls
    - Configurable as six single-ended, six dual-edge symmetric, or three dual-edge asymmetric outputs
  - Up to three 32-bit eQEP modules
  - Device identification
    - Factory programmable electrical fuse farm (FuseFarm)
      - Production ID
      - Device part number (unique JTAG ID)
      - Device revision (readable by host ARM)
      - Feature identification
  - Debug interface support
    - JTAG and cJTAG for ARM (Cortex-A9 and PRCM) and PRU-ICSS Debug
    - Supports real-time trace pins (for Cortex-A9)
    - 64-KB embedded trace buffer (ETB)
    - Supports device boundary scan
    - Supports IEEE 1500
- Other applications:
- Patient monitoring
  - Navigation equipment
  - Industrial automation
  - Portable data terminals
- DMA
    - On-chip enhanced DMA controller (EDMA) has three third-party transfer controllers (TPTCs) and one third-party channel controller (TPCC), which supports up to 64 programmable logical channels and eight QDMA channels
    - EDMA is used for:
      - Transfers to and from on-chip memories
      - Transfers to and from external storage (EMIF, GPMC, and slave peripherals)
  - Inter-Processor Communication (IPC)
    - Integrates hardware-based mailbox for IPC and Spinlock for process synchronization between the Cortex-A9, PRCM, and PRU-ICSS
  - Boot modes
    - Boot mode is selected through boot configuration pins latched on the rising edge of the PWRONRSTn reset input pin
  - Camera
    - Dual port 8- and 10-bit BT656 interface
    - Dual port 8- and 10-bit including external syncs
    - Single port 12-bit
    - YUV422/RGB422 and BT656 input format
    - RAW format
    - Pixel clock rate up to 75 MHz
  - Package
    - 491-Pin BGA package (17-mm × 17-mm) (ZDN suffix), 0.65-mm ball pitch with via channel array technology to enable low-cost routing



- Bar code scanners
- Point of service
- Portable mobile radios
- Test and measurement

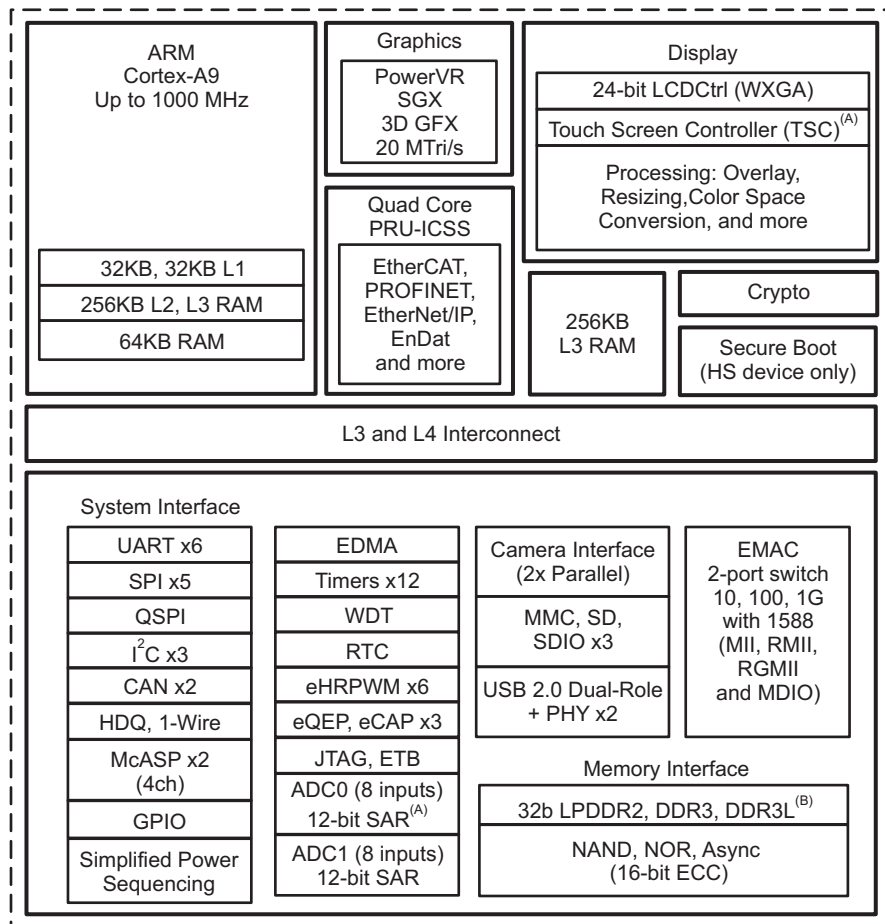

Copyright © 2016, Texas Instruments Incorporated

図 4. AM437x Functional Block Diagram

The TI AM437x high-performance processors are based on the ARM Cortex-A9 core.

The processors are enhanced with 3D graphics acceleration for rich graphical user interfaces, as well as a coprocessor for deterministic, real-time processing including industrial communication protocols, such as EtherCAT, PROFIBUS, EnDat, and others. The devices support high-level operating systems (HLOS). Linux® is available free of charge from TI. Other HLOSs are available from TI's Design Network and ecosystem partners.

These devices offer an upgrade to systems based on lower performance ARM cores and provide updated peripherals, including memory options such as QSPI-NOR and LPDDR2.

The processors contain the subsystems shown in 図 4, and a brief description of each follows.

The processor subsystem is based on the ARM Cortex-A9 core, and the PowerVR SGX® graphics accelerator subsystem provides 3D graphics acceleration to support display and advanced user interfaces.



The PRU-ICSS is separate from the ARM core and allows independent operation and clocking for greater efficiency and flexibility. The PRU-ICSS enables additional peripheral interfaces and real-time protocols such as EtherCAT, PROFINET, EtherNet/IP, PROFIBUS, Ethernet Powerlink, Sercos, EnDat, and others. The PRU-ICSS enables EnDat and another industrial communication protocol in parallel. Additionally, the programmable nature of the PRU-ICSS, along with their access to pins, events and all system-on-chip (SoC) resources, provides flexibility in implementing fast real-time responses, specialized data handling operations, custom peripheral interfaces, and in off-loading tasks from the other processor cores of the SoC.

High-performance interconnects provide high-bandwidth data transfers for multiple initiators to the internal and external memory controllers and to on-chip peripherals. The device also offers a comprehensive clock-management scheme.

One on-chip analog to digital converter (ADC0) can couple with the display subsystem to provide an integrated touch-screen solution. The other ADC (ADC1) can combine with the pulse width module to create a closed-loop motor control solution.

The RTC provides a clock reference on a separate power domain. The clock reference enables a battery-backed clock reference.

The camera interface offers configuration for a single- or dual-camera parallel port.

Cryptographic acceleration is available in every AM437x device. Secure boot can also be made available for anti-cloning and illegal software update protection. For more information about secure boot, contact your TI sales representative.

### 3 System Design Theory

The working principle is based on the elapsed ToF of a modulated light emitted by the light source and reflected back by the object to the photosensitive receiver. The very high photosensitivity allows operating ranges up to several meters and accuracy down to a few centimeters depending on the receiver optics and the illumination power. Each component of this camera system more or less affects the key parameters as measurement range, field of view, frame rate, and accuracy. Each application has different requirements concerning these parameters.

#### 3.1 Sensor Board

A good place to start is to look at some of the available camera system technologies and weigh the pros and cons of each.  5 summarizes some of the popular options available today.

	Time of Flight (ToF)	Stereoscopic vision	Fixed structured light	Programmable structured light (DLP)
Operational principle	IR pulse, measure light transit time	Two 2D sensors emulate human eyes	Single pattern visible or IR illumination, detects distortion	Multiple pattern visible or IR illumination, detects distortion
Point cloud generation	Direct out of chipset	High SW Processing	Medium SW processing	SW processing scales with # of patterns
Latency	Low	Medium	Medium	Medium
Active illumination	Yes	No	Yes	Yes - customizable spectrum
Low light performance	Good	Weak	Good	Good
Bright light performance	Medium	Good	Medium / weak <i>Depends on illumination power</i>	Medium / weak <i>Depends on illumination power</i>
Power consumption	Medium/high <i>Scales w/ distance</i>	Low	Medium	Medium <i>Scales with distance</i>
Range	Short to long range <i>Depends on laser power &amp; modulation</i>	Mid range <i>Depends on spacing between cameras</i>	Very short to mid range <i>Depends on illumination power</i>	Very short to mid range <i>Depends on illumination power</i>
Resolution	QQVGA, QVGA -> Roadmap to VGA	Camera Dependent	Projected pattern dependent	WVGA to 1080p -> Roadmap to WQXGA
Depth accuracy	mm to cm <i>Depends on resolution of sensor</i>	mm to cm <i>Difficulty with smooth surface</i>	mm to cm	µm to cm
Scanning speed	Fast <i>Limited by sensor speed</i>	Medium <i>Limited by software complexity</i>	Medium <i>Limited by SW complexity</i>	Fast / medium <i>Limited by camera speed</i>

 5. Comparison of 3D Imaging Technology

The ToF camera technology is clearly the best candidate because this is a cost-effective, mechanically compact depth imaging solution, unaffected by varying environmental illumination, delivers depth values for each pixel without the need of complex calculation algorithms, and vastly simplifies the figure-ground separation commonly required in scene understanding.

The ToF camera sensor is the key component of this reference design system. However, the ToF camera sensor is not the only part that affects performance. The number of pixels defines the resolution of the camera. Additionally, each pixel provides the system with depth information of the corresponding point in the scene. For a people counting application where multiple people might be engaged in close interactions, high sensor resolution and high depth accuracy are absolutely necessary to be able to detect and count people accurately. Therefore, to best demonstrate the performance of this TI Design system, the OPT8241 ToF sensor is selected as shown in 図 6. The OPT9221 ToF controller is the ToF sensor's companion device that computes the depth data from the digitized sensor data.

	Status	Device Type	Sensor Resolution	Output Format	Interface	Frame Rate (Max) (FPS)	Pixel Pitch (um)	Operating Temperature Range (C)	Rating	Estimated Package Size (WxL) (mm <sup>2</sup> )	Package Group
<input type="checkbox"/> ACTIVE <input type="checkbox"/> Sensor + AFE <input type="checkbox"/> Single Chip <input type="checkbox"/> ToF Controller		<input type="checkbox"/> NA <input type="checkbox"/> 80x60 <input type="checkbox"/> 320 x 240	<input type="checkbox"/> Depth Data <input type="checkbox"/> Raw Sensor Data	<input type="checkbox"/> DVP Compatible <input type="checkbox"/> DVP, SSI <input type="checkbox"/> LVDS <input type="checkbox"/> SSI Compatible	<input type="checkbox"/> 120 <input type="checkbox"/> 1000	<input type="checkbox"/> 15 <input type="checkbox"/> 30	<input type="checkbox"/> 0 to 70	<input type="checkbox"/> Catalog	<input type="checkbox"/> 56COG: 8.06 x 5.321: 43 mm <sup>2</sup> <input type="checkbox"/> 78COG: 8.757 x 7.859: 69 mm <sup>2</sup> <input type="checkbox"/> 256NFBGA: 9 x 9: 81 mm <sup>2</sup>	<input type="checkbox"/> COG <input type="checkbox"/> NFBGA	
<b>Compare Parts</b>											
<input type="checkbox"/> OPT8320 - 80x60 QQVGA Resolution 3D Time of Flight Sensor & Controller	NEW ACTIVE	Single Chip	80x60	Depth Data	DVP, SSI	1000	30	0 to 70	Catalog	56COG: 8.06 x 5.321: 43 mm <sup>2</sup>	COG
<input checked="" type="checkbox"/> OPT8241 - QVGA-Resolution 3D Time-of-Flight (ToF) Sensor	ACTIVE	Sensor + AFE	320 x 240	Raw Sensor Data	LVDS	-	15	0 to 70	Catalog	78COG: 8.757 x 7.859: 69 mm <sup>2</sup>	COG
<input checked="" type="checkbox"/> OPT9221 - Time-of-Flight (ToF) Controller for OPT8241	ACTIVE	ToF Controller	NA	Depth Data	DVP Compatible SSI Compatible	120	-	0 to 70	Catalog	256NFBGA: 9 x 9: 81 mm <sup>2</sup>	NFBGA

図 6. Parametric Table for Selection of 3D ToF Sensor

The sensor board consists of the OPT8241 ToF sensor chip, lens with lens holder, the OPT9221 ToF controller, DDR2 memory, boot EEPROM, USB transceiver, and power management devices. The lens and the lens holder both are custom-designed parts. To use standard off-the-shelf lenses, a standard M12 lens holder footprint has been provided. The sensor board communicates with the host controller board over USB interface. The sensor board carries a 2.1-mm jack for power supply from a 5-V DC adaptor. The sensor board consists of all interconnects and the corresponding connectors. The illumination board is mechanically held to the sensor board using spacers. The electrical connections between the illumination board and sensor board are achieved using a flex cable.

### 3.2 Illumination Board

The illumination source is equally responsible for system performance as the OPT8241 ToF sensor chip itself. The light power has to be as high as possible while running inside the eye-safety norms. Additionally, the illumination board has to be small, efficient, and match the same field of view as it is captured by the ToF camera. The illumination source could be either a light emitting diode (LED) or laser. The efficiency (electrical to optical power) of modern LEDs is typically up to 30%. The modulation circuitry could be implemented easily due to a linear electro-optical characteristic and beam shaping is done by an integrated LED optics. LEDs were mainly chosen targeting very low system cost at high volumes. ToF systems give better results at higher frequency because higher modulation frequency provides better range measurement precision. However, LEDs usually do not work well beyond 24 to 30 MHz. Therefore, beyond such frequencies, it is recommended to use lasers.

One advantage lasers have over LEDs is that the efficiency of lasers actually increases at higher currents. Laser diodes have efficiencies up to 50%. The TI ToF sensors usually work best in the range of 40 to 60 MHz. Therefore, to best use TI's ToF, lasers can be used. However, the cost of lasers may be higher than LEDs, and eye safety is a concern when operating laser systems.

The OPT8241 always needs an external illumination driver circuitry. The illumination board consists of four NIR laser diodes mounted with diffusers and the laser driver circuitry. The optical output power of the illumination board is controlled using an I<sup>2</sup>C interface-based digital potentiometer. The modulation control of the illumination is done by the OPT8241 sensor and the corresponding signals from the sensor board to the illumination board through a flex cable.

### 3.3 Host Controller Board

The AM437x GP EVM is a standalone test, development, and evaluation module system that enables developers to write software and develop hardware around an AM437x processor subsystem. The main elements of the AM437x subsystem are already available on the base board of the EVM, which gives developers the basic resources needed for most general purpose type projects that encompass the AM437x as the main processor. Furthermore, additional, "typical-type" peripherals are built into the EVM, such as memory, sensors, LCD, Ethernet physical layer (PHY), and so on, so that prospective systems can be modeled quickly without significant additional hardware resources.



図 7. AM437x GP EVM Top View



図 8. AM437x GP EVM Bottom View

注: The AM437x Starter Kit (SK) can also be used as the controller board. This board contains different peripherals and connections, so the supporting documentation should be followed to alter the hardware setup and other instructions detailed in this design guide.

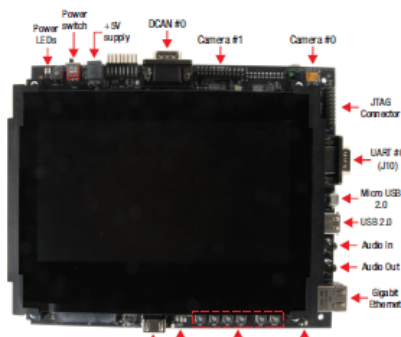
### 3.3.1 Higher Performance Controller Board Options

The Sitara family offers a highly integrated, scalable platform of devices. For systems integrating multiple ToF sensors and doing advanced signal processing, AM57x offers higher performance ARM Cortex-A15 cores along with C66x floating point DSPs.

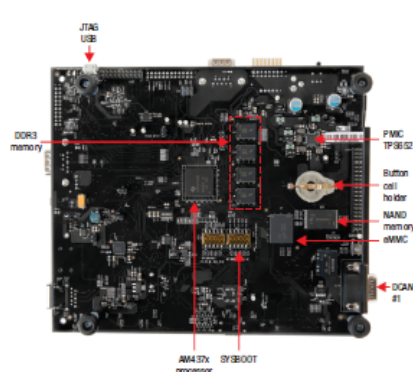
The ToF Voxel SDK is fully integrated into the TI Processor Linux SDK, which enables scalability across different processor families for simplified development and migration.

## 3.4 Demand Controlled Ventilation

Ventilation is a critical component of heating, ventilating, and air conditioning (HVAC) systems; it delivers fresh air to building occupants, maintains building pressurization, provides cooling, and more. In a building, contaminants build up over time. Some contaminants come from outside, some come from inside, and some come from the occupants. The main goal of ventilation is to reduce airborne contaminants by diluting indoor air, which has a higher concentration of contaminants, with outdoor air that has less contaminant to maintain indoor air quality (IAQ) within accepted limits for both the health and comfort of the occupants.

However, in conventional HVAC design, ventilation systems are designed based on the assumption that the building will always be at peak occupancy, the worst-case scenario. Fixed ventilation systems provide a constant intake of fresh air. Whenever the space is nearly empty, conventional ventilation systems are providing more ventilation than what is needed. Overventilation increases heating and cooling loads as well as excessive fan usage, all of which contribute to a significant waste of energy and money.

Scheduled ventilation can provide fresh air at the correct rates at the right time, but run at the risk of under- or overventilation if schedule changes are not made at the appropriate times. Much of this energy can be saved through demand control ventilation (DCV).

DCV adjusts outside ventilation air based on the number of occupants and the ventilation demands that those occupants create. This accomplishes two things. First, DCV saves energy by not heating or cooling unnecessary quantities of outside air. Second, DCV can provide assurance that sufficient outside air is being supplied to the occupants.

Historically, CO<sub>2</sub> sensor based DCV system are most popular and widely used sensor. When most people implement a DCV strategy, they think CO<sub>2</sub> sensing in a space will be required automatically. However, CO<sub>2</sub> sensing may not be the best choice for the following reasons:

- The high level of uncertainty between the number of people and CO<sub>2</sub> concentration levels makes predicting the real-time occupancy numbers using CO<sub>2</sub>-based systems challenging.
- Lagging indicator of occupancy; by the time sensors detect high levels of CO<sub>2</sub> that trigger ventilation control, occupants may already be in a state of discomfort.
- Subjected to accuracy drift over time.
- Requires proper periodic maintenance such as cleaning and recalibration.
- Their performance is affected by the presence of other gases, humidity, vibration, and air pressure.
- CO<sub>2</sub> concentration levels may be affected by factors other than occupancy, such as passive ventilation, open windows, or air infiltration.
- Locating a CO<sub>2</sub> sensor is difficult because it requires to first understand the dynamics of indoor CO<sub>2</sub> levels and multipoint measurement of CO<sub>2</sub> concentration in an occupied room.

3D ToF based people counting for DCV systems can be much more efficient in controlling and regulating equipment than gas sensor measurement and likely require less maintenance. A 3D ToF camera system provides direct and accurate measurement of an occupancy level to the ventilation control system in real time that timely triggers the controls to achieve the intended ventilation. The 3D ToF camera can be integrated easily to the DCV systems through either a wired or wireless link as shown in 9.



図 9. 3D ToF Camera Based DCV System



### 3.5 People Tracking Algorithm Using a Depth Camera

A key benefit a depth camera has is the ability to use depth to segregate foreground from the background. Once foreground objects are isolated, they can be recognized, tracked, and counted using modern image processing algorithms available in OpenCV. This section describes the theory on how to create a simple people counter and tracking application.

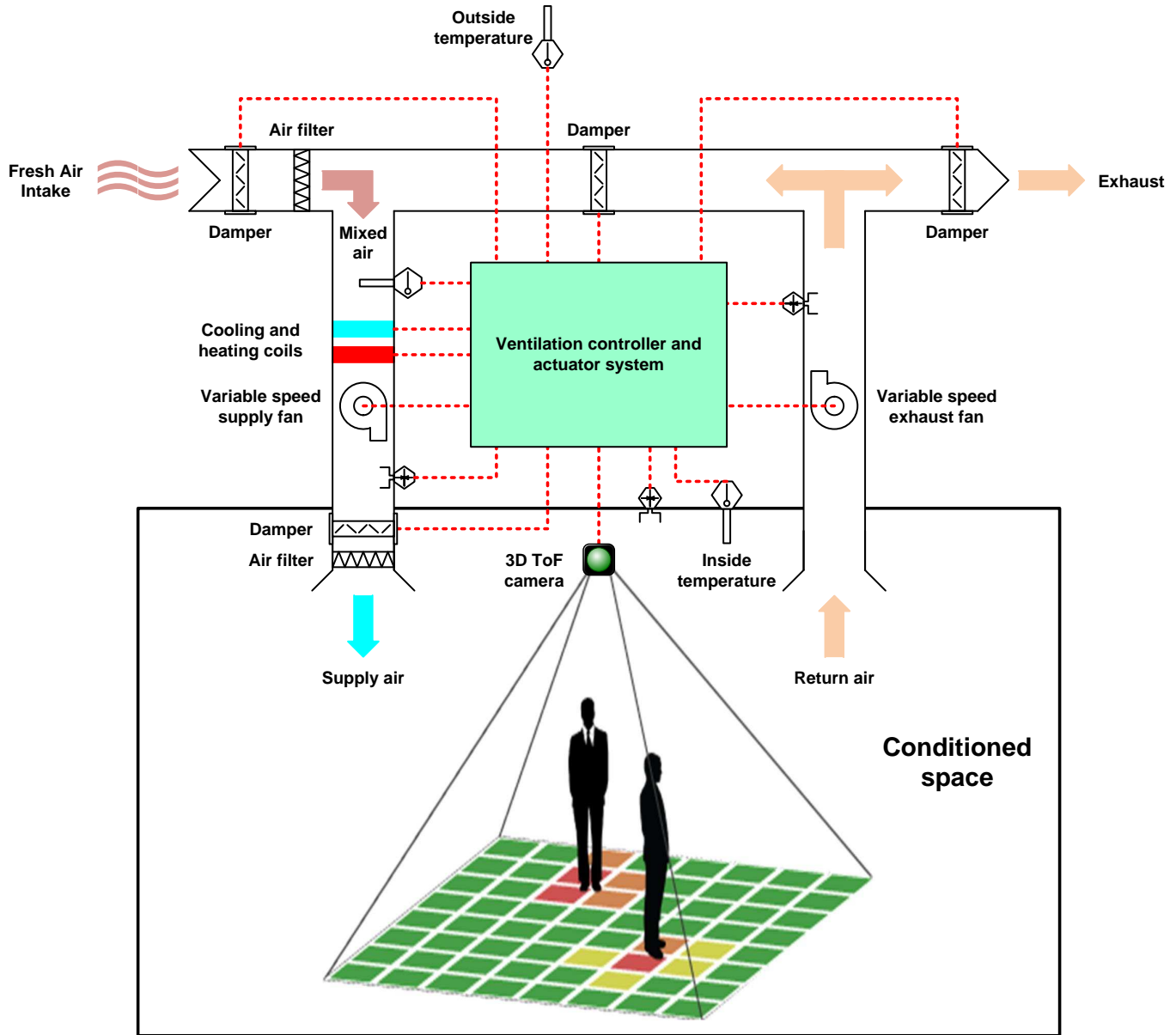
The general strategy of people counting and tracking is as follows:

- Foreground-background separation
- Convert to binary image and apply morphology filters
- Shape analysis
- Tracking

#### 3.5.1 Foreground-Background Separation

Foreground-background separation starts with registering the background, which is necessary before one can separate foreground from background through image subtraction. If a depth camera is used, image subtraction would be the difference between two depth images.

##### 3.5.1.1 Simple Approach to Registering Background

Setting the background could be as simple as capturing a frame when the scene is absent of foreground objects. However, the simple approach will detect background objects that may have moved from its original location.

##### 3.5.1.2 Sophisticated Approach to Registering Background

A more sophisticated approach would be to slowly fade in any alteration back into the background. For example, if the change is not a recognized object to be tracked, the alteration can be added to the background. Another example is if the alteration has sustained a period of no change, it can be considered background.

If the sophisticated approach is adopted, the definition of foreground is the fast-changing component of the scene, and background is the slow-changing component. The rate at which the foreground fades into the background should be a programmable parameter that depends on the type of applications.

##### 3.5.1.3 Image Subtraction

After subtraction, the result would be from newly present or absence of objects. To reduce the impact of camera noise, the "foreground" may need to be further qualified by minimum delta depth ("thickness") and minimum amplitude ("brightness").

The code example illustrates a simple case of foreground-background separation:

```
void Horus::clipBackground(Mat &dMat, Mat &iMat, float dThr, float iThr)
{
    for (int i = 0; i < dMat.rows; i++) {
        for (int j = 0; j < dMat.cols; j++) {
            float val = (iMat.at(i,j)>iThr && dMat.at(i,j)>dThr) ? 255.0 : 0.0;
            dMat.at(i,j) = val;
        }
    }
}
```

where  $iThr$  is the amplitude (brightness) threshold, and  $dThr$  is the depth threshold.

### 3.5.2 Binary Image and Morphology Filter

The foreground from subtraction may contain speckles to noise, as noise varies from frame to frame. The morphology operators can be applied to remove speckles and fill in small gaps. The open operator first erodes the image using the chosen morphology element, then dilates the result to fill in the gaps and smooth the edges.



☒ 10. Background Subtraction Binary Image

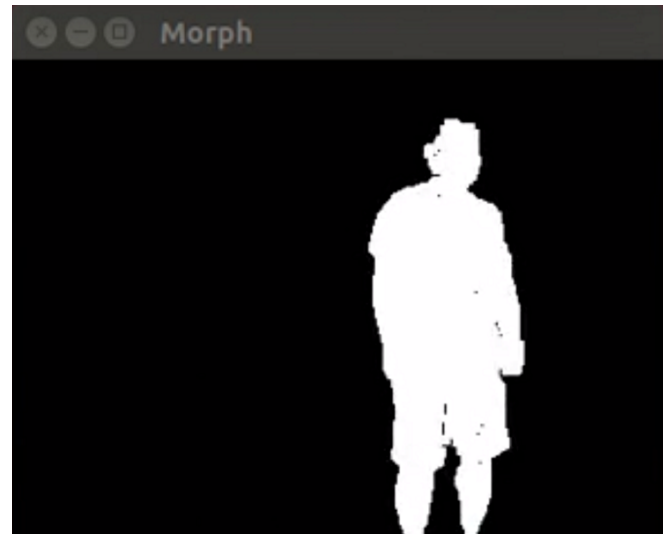

☒ 11. Morphology Filter on Binary Image

### 3.5.3 Shape Analysis

After the foreground is isolated as a binary image, shape analysis can be performed to find individual objects in the foreground. This step is where people counting solutions vary, depending on the application.

Also, people tracking algorithms depend heavily on camera angles. Algorithms for ceiling-mounted camera are generally simpler than those for corner-mounted cameras. Objects from the ceiling view look like well-formed blobs, but from the corner, objects become complex overlapping silhouettes, which are harder to separate.

In the rest of the section, various shape analysis theories are explained that can be relevant to people tracking and counting. Most of the algorithms are available in OpenCV.



### 3.5.3.1 Blob Analysis

Blob analysis works by connecting joined, self-enclosing regions in the foreground sharing common properties such as area, thresholds, circularity, inertia and convexity. Proper selection of these properties can greatly enhance accuracy. A summary article on blob analysis with example code is available from Satya Mallick.



図 12. Blob Parameters[9]

Blob analysis works best when the camera is ceiling mounted because people will generally look like well-formed blobs from this perspective. However, people in physical contact with one another can cause their blobs to join, leading to a miscount. The erode operator is useful in this case as it can split thinly connected blobs.

### 3.5.3.2 Contour Analysis

Foreground shapes can also be recognized and tracked by contours, a list of points that form a self-enclosing outline of the foreground object it encloses. Each contour has both a length and an enclosed area property. The contour properties can be analyzed to determine if the contour reflects a "person". With proper settings, the number of contours in the foreground can be the people counter.

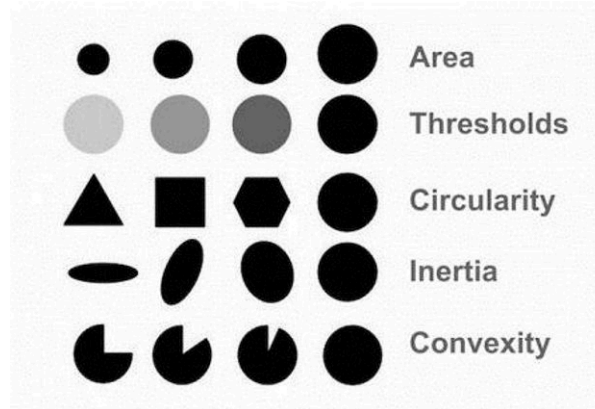
A key benefit of contours is the ability to identify appendages or body parts such as fingers, legs, arms, and shoulders. This ability is available through contour operators like convex hull and convexity defects. In the example shown in 図 13, the convex hull is the vertices of the green convex polygon, and the convexity defects are the red points at the bottom of "valleys". The valleys are called convexity defects because they represent violations of convexity. Once convex hull and convexity defects are identified, along with the contour centroid and some heuristics, an algorithm can be developed to identify head, arms, and legs of a person.



図 13. Convex Hull and Convexity Defects

### 3.5.3.3 Region Growing

For corner-mounted cameras, people in the foreground may overlap, especially in a crowded room. The point cloud of the foreground pixels should be exploited to group points belonging to the same individual. The region growing algorithm can be applied to group pixels having similar  $z\cos(\theta)$  distance from the camera, where  $\theta$  is the camera pitch angle.

The first step is finding suitable seeding points. One way is to histogram each foreground blob and identify the top two or three local maxima with each maxima meeting some minimum separation requirement. Then, seed the point in each maxima that is closest to the centroid of all points belonging to the same maxima. To grow the region, set each seed as the center, then scan the eight neighbors to qualify or disqualify them into the group based on the  $z\cos(\theta)$  distance. Then with each qualified neighbor as the center, repeat the same eight-neighbor scan to expand the group. The result of an example is given in [Figure 14](#).

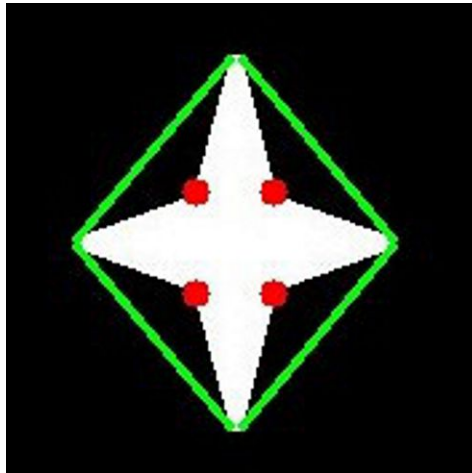

図 14. Region Growing Algorithm in People Counting[8]

### 3.5.4 Tracking

In some applications, tracking the movement of people in a room is important (for example, monitoring presence of suspicious or unusual activities, or quantifying the interest of a crowd to particular products or showcases). Tracking also enables one to maintain a proper head count in situations where people may be partially or even fully obstructed. In these scenarios, if the tracker has not detected any people leaving the scene from the sides of the camera view, then any disappearing blobs must be due to occlusion; therefore, the head count must remain unchanged.

Tracking requires matching foreground entities in consecutive frames. Matching can be based on multiple criteria such as shortest centroid displacement, similarity of contour shape, and intensity profile. Subtracting consecutive frames will also indicate the direction of motion, enabling prediction of where in the new frame the tracked object is.

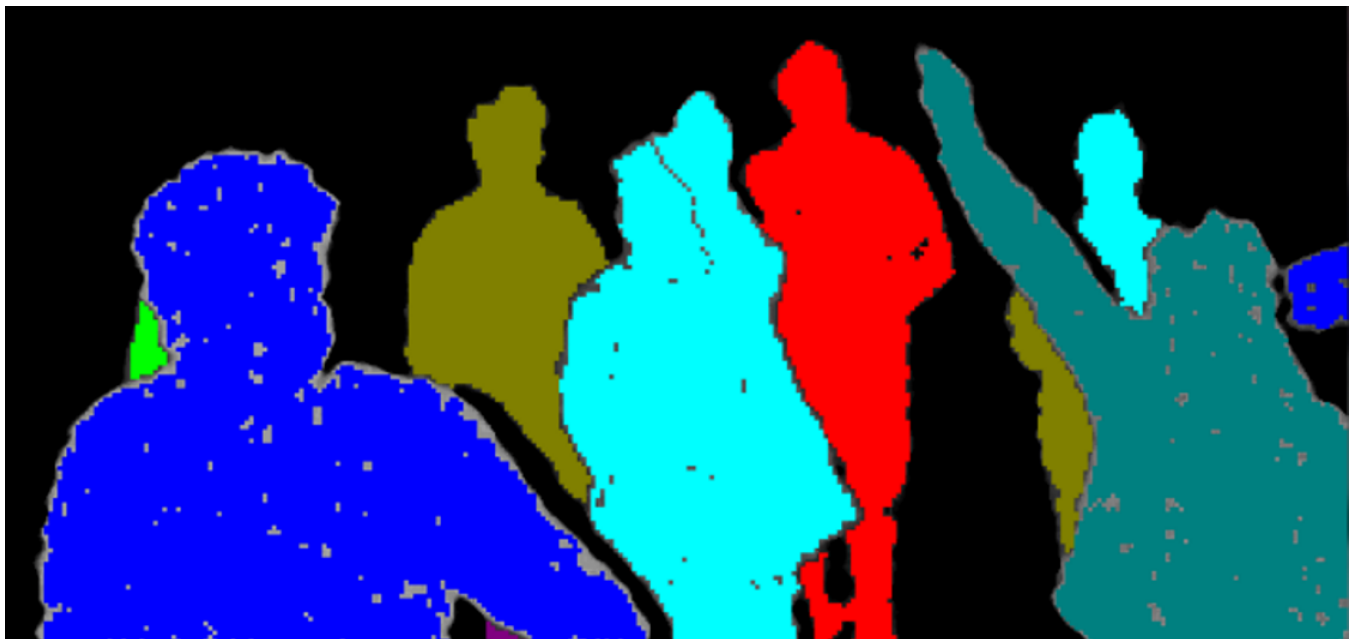
## 4 Getting Started Hardware and Software

### 4.1 Hardware Overview

Follow these steps to make hardware connections as shown in [Figure 15](#).

1. Connect a standard Type A Male Type Micro-B Male USB Cable between J13 connector on the AM437x GP EVM and U4 on the sensor board of the OPT8241-CDK-EVM.
2. Visualize the AM437x desktop environment in one of two ways:
  - (a) LCD: View the produced images on the LCD on the AM437x GP EVM.
  - (b) View generated .png images: Connect an Ethernet cable from the network drop or computer to J4 on the AM437x GP EVM. This setup can be used to transfer the images from the EVM to another computer by using a tool such as WinSCP.
3. Ensure that the power switch (SW2) on the sensor board of the OPT8241-CDK-EVM is in the off position, which is to the left.
4. Apply 5-V DC power to the J1 connector on the AM437x GP EVM and the J3 connector on the sensor board of the OPT8241-CDK-EVM with the help of 1 male plug to 2 female Jack cable splitter 5.5x2.1-mm adaptor.
5. Move the power switch (SW2) on the sensor board of the OPT8241-CDK-EVM to the on position (to the right).
6. Check that the master LED is green and the chipset LED is blue on the sensor board of the OPT8241-CDK-EVM.

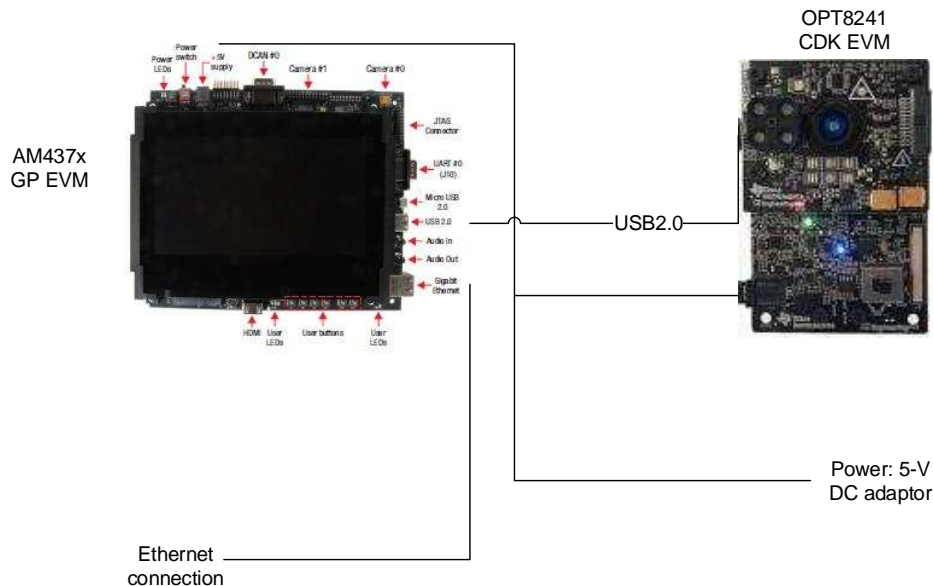

**Figure 15. Hardware Setup**

## 4.2 Getting Started Software

The following section describes how to setup the SDK containing the Simple People Tracking application on the AM437x GP EVM, and how to run the demo. Running the application will be detailed both for using the SDK's Matrix App Launcher GUI and for using the command line. This TI Design was tested with AM437x PLSDK version 3.3.

### 4.2.1 Create an SD Card with the Processor Linux Software Development Kit (SDK)

The Processor Linux SDK can be easily written to an SD card using a Windows machine. This SD card can then be inserted into the AM437x GP EVM to run the Simple People Tracking application. The latest Processor Linux SDK can be found [here](#). The file that needs to be written to the SD card is the \*.img.zip file. Instructions on creating the SD card in Windows with this image file can be found [here](#).

### 4.2.2 Running Simple People Tracking

Once the hardware is setup as described in [4.1](#) and the SD card with the SDK has been inserted into the AM437x GP EVM, the application can be run. There are two ways to run the application, both of which will be described below. Using the Matrix App Launcher GUI is the simplest method, and does not require another computer to control the AM437x GP EVM from its command line. Using another computer to connect serially with the AM437x GP EVM requires an additional connection, but this method allows the user to easily update parameters such as the frame resolution and the frame speed.

#### 4.2.2.1 Using the Matrix App Launcher

The SDK includes the Matrix App Launcher GUI, which runs and displays on the LCD upon startup. Information on the Matrix App Launcher can be found in the Processor SDK Linux Getting Started Guide, and a more detailed description can be found in the [Matrix Users Guide](#).

The demo can be started by using the touchscreen on the LCD to navigate to the Simple People Tracking application. The Simple People Tracking application can be found in the "MachineVision" folder, which can be seen in [Figure 16](#).



☒ 16. Matrix App Launcher Main Screen

Clicking on the "MachineVision" folder will open the MachineVision submenu, as seen in ☒ 17, where the Simple People Tracking application can be found. Once the application has been selected, the "RUN" button can be pressed to start the demo. Running the demo through the Matrix App Launcher will use the following default values:

- Resolution: 160 x 120
- Frame rate: 30 fps

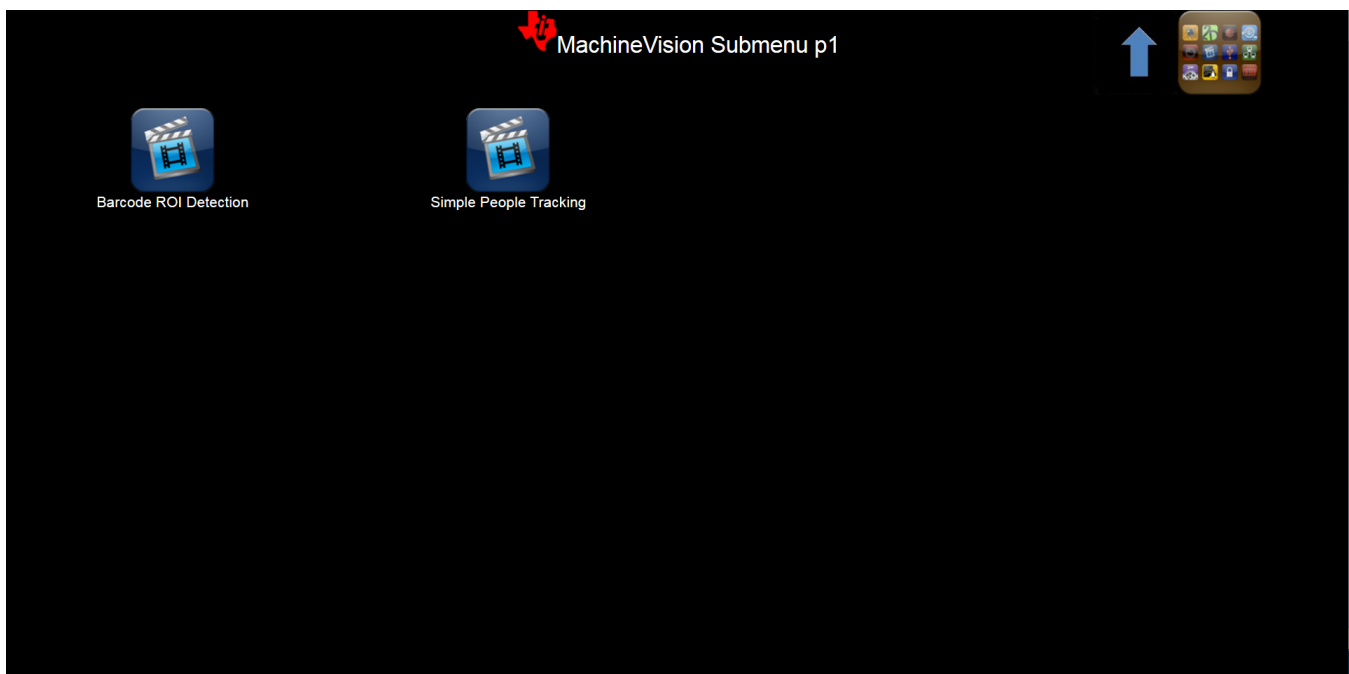

☒ 17. MachineVision Submenu Screen

The LCD updates with each frame, providing a continuous image of the view of the camera. As soon as the output of the application appears on the display (this may take a second or two), the background has been updated. Running the application from the Matrix App Launcher will display a binary image of the depth map obtained by the camera, along with the tracing of figures and the number of identified figures in the foreground (the count). This can be seen in [Figure 18](#).

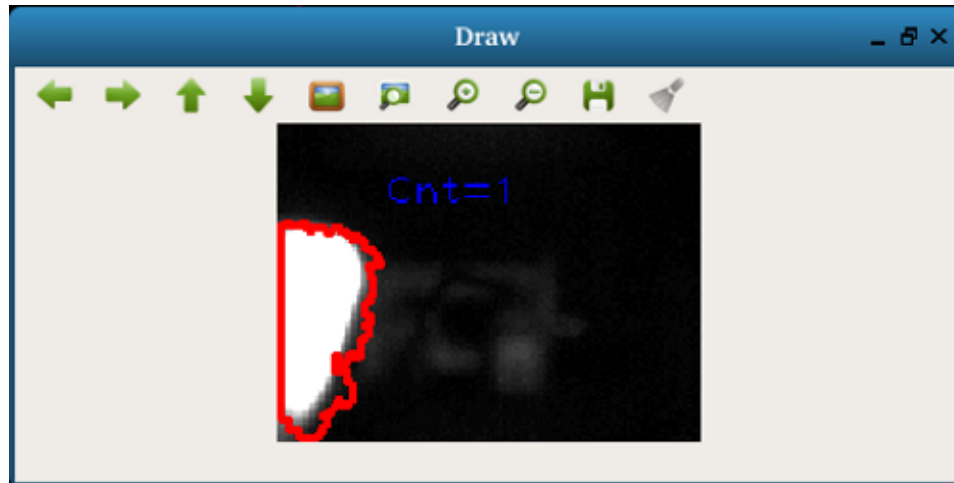

**Figure 18. Output Display of Simple People Tracking**

Running this application from the Matrix App Launcher runs a script called `runSimplePeopleTracking.sh`, which is located in `/usr/bin` in the SDK. This script can be modified to change the resolution and frame rate from the default values. If done on the AM437x GP EVM (as opposed to using a serial connection to access the command line), the following can be called to stop the Matrix App Launcher and then start it back up again once the script has been modified:

```
/etc/init.d/matrix-gui-2.0 stop
/etc/init.d/matrix-gui-2.0 start
```

To exit from the application back to the Matrix App Launcher, simply tap the application window on the touchscreen LCD.

### 4.2.2.2 Using a Serial Connection to Access the Command Line

The People Counting application can be run on the AM437x GP EVM by using the command line. Because the ToF CDK is using the only USB port on the EVM, the best way to access the command line is by using a serial connection to a computer. This can be done by connecting the UART serial cable that is provided with the AM437x GP EVM to the DB-9 (J10) connector on the AM437x GP EVM. Any terminal window can be used to access the command line. When the port corresponding to the AM437x GP EVM is chosen, the enter key can be pressed to get the screen shown in [Figure 19](#). The following can be used to login:

```
am437x-evm login: root
```

The People Counting application can be run as follows:

```
root@am437x-evm:~# cd /usr/bin
root@am437x-evm:/usr/bin# SimplePeopleTracking
```

Note that this application should be run from the directory specified above. Running the application without any options (like above) will update the LCD with each frame, providing a continuous image of the view of the camera. It will display a binary image of the depth map obtained by the camera, along with the tracing of figures and the number of identified figures in the foreground (the count). If no options are specified, the application will be run with the following default values:

- Resolution: 160 × 120
- Frame rate: 30 fps

The application can be exited by pressing the 'q' key. The background can be updated to the current frame by pressing the 'b' key. This will be the new background that will be used to determine if people enter the space after this background frame is captured.





図 19. Arago Project Login Screen

### 4.2.3 Options for the Application

The Simple People Tracking application can be run with options to change the resolution and frame rate, as well to save frames as .pngs instead of showing the display on the LCD. This shows an example that runs the application with the a resolution of 160 × 120 and a frame rate of 30 fps:

```
root@am437x-evm:/usr/bin# SimplePeopleTracking -w 160 -h 120 -f 30
```

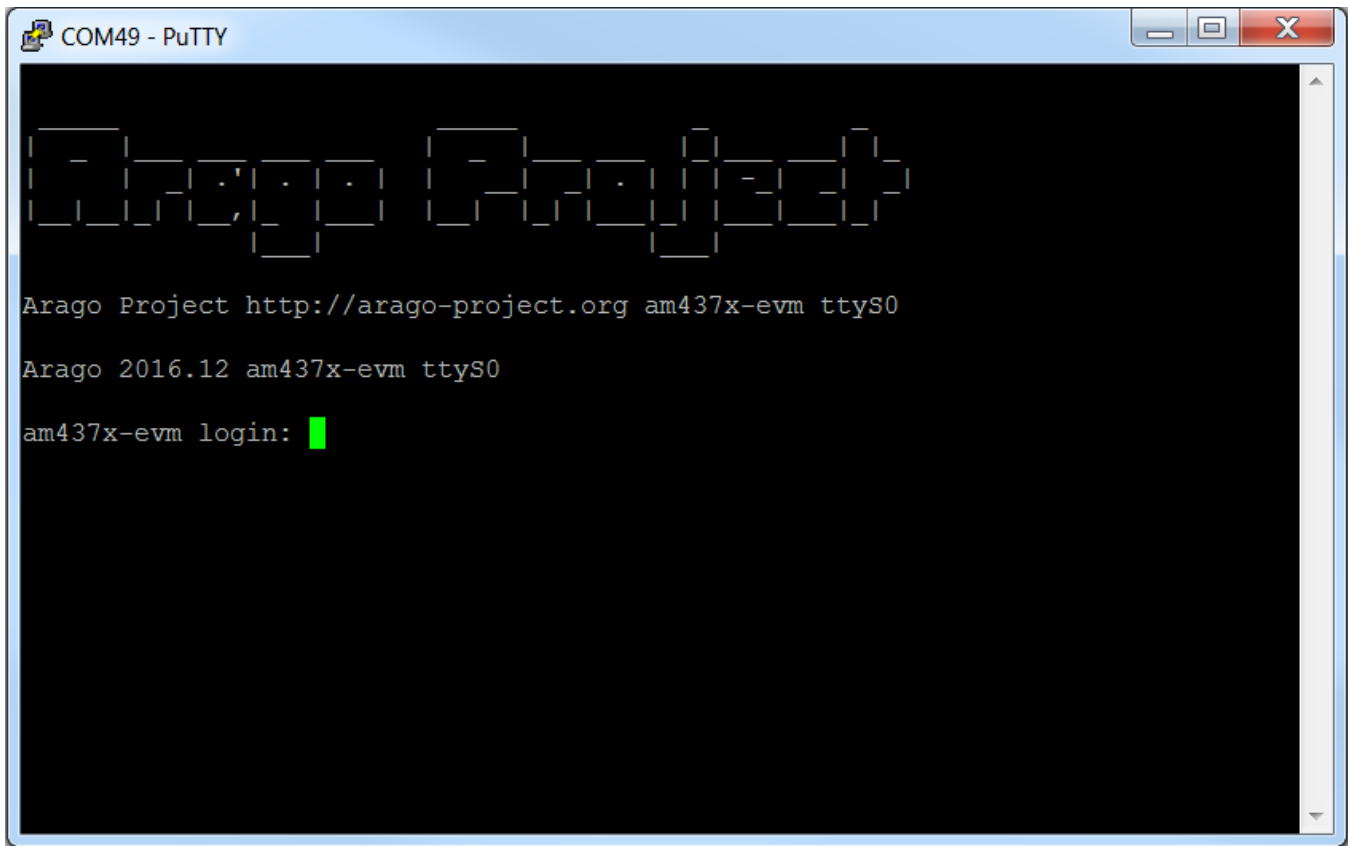
The application can also be configured to save .pngs instead of updating the LCD, which is useful when using a setup without a display:

```
root@am437x-evm:/usr/bin# SimplePeopleTracking -s 30
```

This option means that every 30<sup>th</sup> frame is saved as a .png. These frames will be saved in the directory that the application is being run from. Additional options can be added to this as well. For example, this will save every 30<sup>th</sup> frame, while using a resolution of 160 × 120 and a frame rate of 30 fps:

```
root@am437x-evm:/usr/bin# SimplePeopleTracking -s 30 -w 160 -h 120 -f 30
```

---

**注:** Since the frame rate is 30 frames per second and the picture is saved every 30 frames, the application will save 1 frame per second. The application will terminate after it has saved 10 frames.

---

The full list of available options and their descriptions can be displayed by calling:

```
root@am437x-evm:/usr/bin# SimplePeopleTracking -h
SimplePeopleTracking: option requires an argument -- 'h'
```

Following command line options available:

-s <decimal value>

If you want to run demo without keyboard, provide 'skipped\_frames' as argument (e.g. SimplePeopleTracking -s 30)!

Images with the result of processing are saved in PNG files. This test always stops after 10 image files recorded.

-w <resolution width, default is 160, another resolution possible is 320x240>

-h <resolution height, default is 120, another resolution possible is 320x240>

-i <present image of amplitudes, grey-scale like image - default is detection of people>

-d <present distance map - default is detection of people>

-f <set fps with integer value, 30 is default, 10, 15, 25 are another options to try>

### 4.2.4 Simple People Tracking Algorithm

The Simple People Tracking application uses the simple people tracking algorithm.

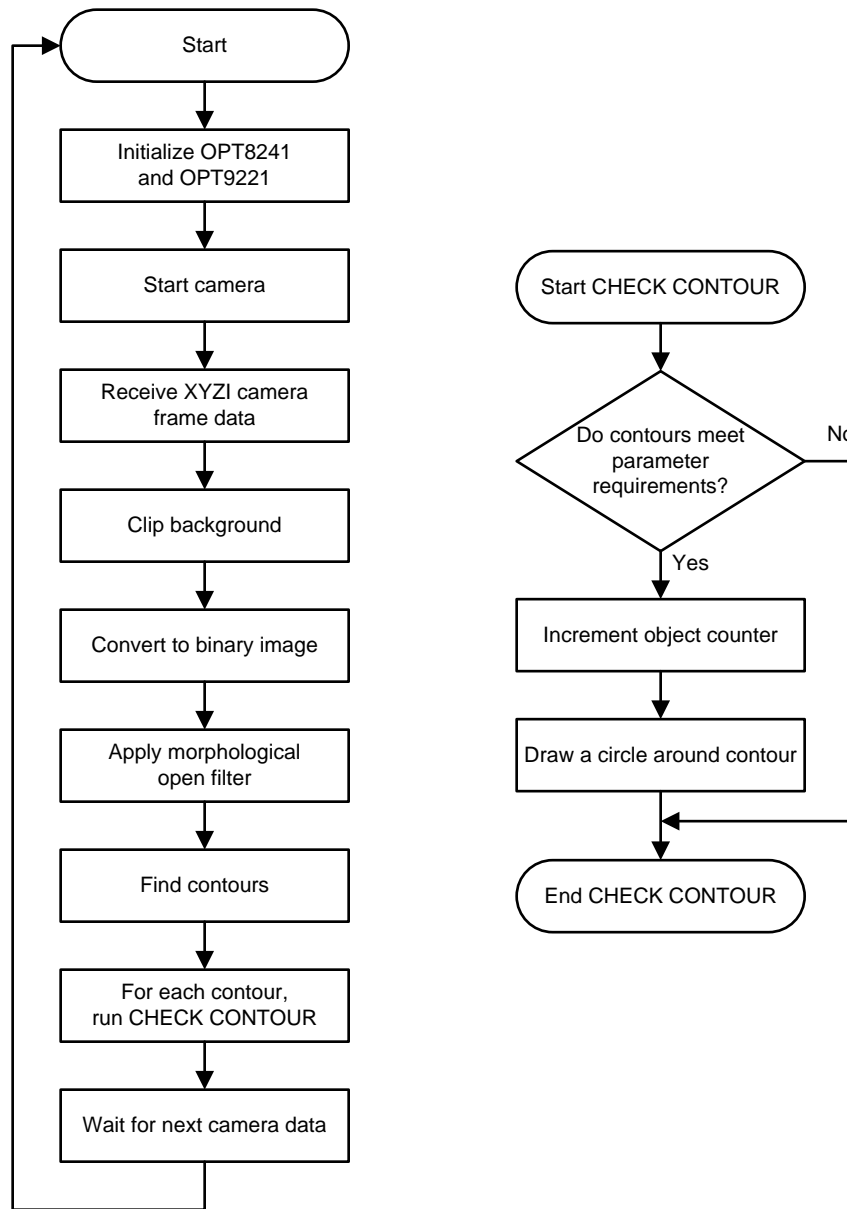

**図 20. Simple People Tracking Algorithm Flow Chart**

As shown in 図 20, this example will perform a simple foreground-background subtraction and use OpenCV contour functions to draw a circle around qualifying foreground objects.

This algorithm also provides an example on how to use basic parameters to quantify if the foreground object is an object of interest. If the contour of the foreground object does not meet the requirements, it will not be counted. The example will try to quantify if the foreground object is a standing person.

1. Contour Area: A person in the camera view will occupy a minimum amount area. A minimum contour area can be used to filter out any small objects that might appear in the foreground.
2. Aspect Ratio: A standing person is taller than they are wider. Use the contour width and height to calculate the aspect ratio of the foreground object. If the resulting aspect ratio is wider than it is tall, then it will not be counted as a person.

This example does not perform more advanced techniques in object tracking or recognition. It is meant as a starter example so that more complex tracking and algorithm can be added on top. For more information about the people tracking theory, see 3.5.

表 2 presents the existing parameters that can be modified in the Simple People Tracking algorithm:

**表 2. Simple People Tracking Parameters**

PARAMETER	FILE	VARIABLE AND DESCRIPTION
Frame size	SimplePeopleTracking.cpp	Horus variable initialization in main function Horus(int width, int height); For 320x160: Horus eye(320, 240); For 160x120: Horus eye(160, 120);
Frame rate	TOFApp.cpp	_frate _frate.numerator _frate.denominator FPS = numerator/denominator
Illumination power	TOFApp.cpp	_illum_power
Illumination duty cycle	TOFApp.cpp	_intg
Camera profile	TOFApp.cpp	_profile Camera profile contains the calibration data. By default, the firmware will use "MetriusLongRange" profile. If another or custom profile is desired, update the "profile" variable with the profile name. To view all profile names that are available on the camera firmware, enable the macro in TOFApp::connect function.
Amplitude gain	Horus.cpp	_ampGain Scale the amplitude output
Amplitude threshold	Horus.cpp	_ampThresh Minimum brightness of object
Depth threshold	Horus.cpp	_depthThresh Minimum thickness of object
Minimum contour area	Horus.cpp	_minContourArea Minimum contour area required before algorithm will consider the contour area as a person
Aspect ratio	Horus.cpp	_aspectRatio Minimum aspect ratio of contour area before algorithm will consider the contour area as a person

## 4.2.5 Rebuilding SimplePeopleTracking

The following steps can be taken to rebuild the application and modify the code:

1. Follow the following instructions to setup and compile the Linux filesystem and kernel for the Arago project:
  - [http://www.processors.wiki.ti.com/index.php/Processor\\_SDK\\_Linux\\_Getting\\_Started\\_Guide](http://www.processors.wiki.ti.com/index.php/Processor_SDK_Linux_Getting_Started_Guide) (Start Your Linux Development section)
  - [http://www.processors.wiki.ti.com/index.php/Processor\\_SDK\\_Building\\_The\\_SDK](http://www.processors.wiki.ti.com/index.php/Processor_SDK_Building_The_SDK)
2. Instead of compiling the complete system (as indicated in the above guides), the voxelsdk can be build alone to save time. This can be done by replacing the last line of the "Build Steps" in the second guide with:

```
MACHINE=am437x-evm bitbake voxelsdk
```

3. The source files can be found in:

```
./build/arago-tmp-external-linaro-toolchain/work/armv7ahf-neon-linux-gnueabi/voxelsdk/<voxelsdk_version>/git/Demos
```

4. Create the updated IPK package by calling the following in the Linux command line:

(a) Compile the voxelsdk:

```
MACHINE=am57xx-evm bitbake voxelsdk --force -c compile
```

(b) Create the new IPK package:

```
MACHINE=am57xx-evm bitbake voxelsdk
```

5. Copy the IPK package from the following location onto the target device:

```
./build/arago-tmp-external-linaro-toolchain/work/armv7ahf-neon-linux-gnueabi/voxelsdk/<voxelsdk_version>/deploy-ipks/armv7ahf-neon/voxelsdk_<voxelsdk_version>_armv7ahf-neon.ipk
```

6. Install the IPK package on the target device by calling the following:

```
opkg install voxelsdk_<voxelsdk_version>_armv7ahf-neon.ipk
```

7. Alternatively, the following can be done instead of Steps 4b and 5: copy the executable located in the following location to /usr/bin of the target system. This step is appropriate only if only demo files are modified. This step will not work if parts of the voxelsdk are modified.

```
./build/arago-tmp-external-linaro-toolchain/work/armv7ahf-neon-linux-gnueabi/voxelsdk/<voxelsdk_version>/build/bin/SimplePeopleTracking
```

## 5 Testing and Results

### 5.1 Test Setup

#### 5.1.1 Power Consumption

To accurately measure supply current, the transformer was cut off from the power supply (leaving only the cable) and replaced with a bench power supply and digital multimeter. This provides the ability to measure the supply current without performing any board modifications. The test setup for the supply current measurements is illustrated in [Figure 21](#). The modified power cable used to connect to the bench meter is shown in [Figure 22](#).

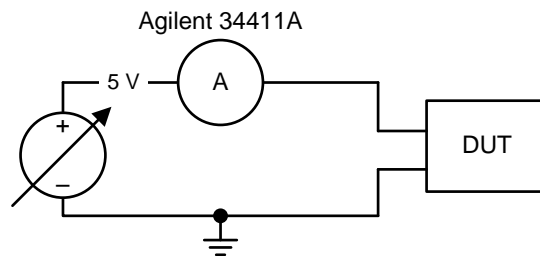

Copyright © 2016, Texas Instruments Incorporated

**Figure 21. Test Circuit Used for Measuring Supply Current**

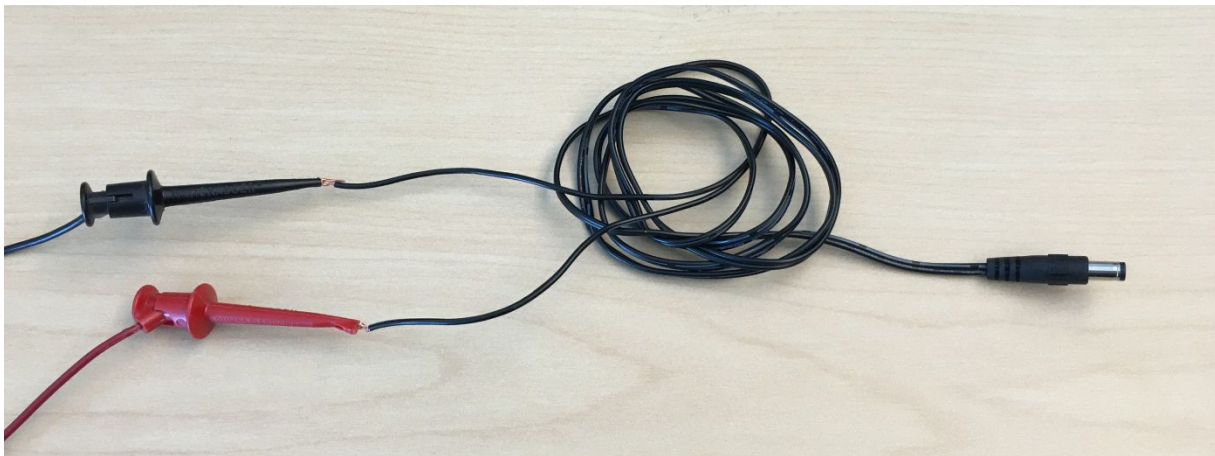

**Figure 22. Power Cable Connection to Bench Meter**



### 5.1.2 Functional

In this setup, the OPT8241 CDK was mounted on top of a tripod, which was placed on top of the table for a combined height of 4 feet. The camera was viewing an area that was 8 feet wide by 8 feet deep. A micro USB cable from the camera is directly connected (with no hub) to the AM437x GP EVM.

The AM437x GP EVM was placed on the table next to the tripod. The LCD on the AM437x GP EVM was used to visual the images produced by the demo. A USB cable was used to form a serial connection from a laptop to the AM437x GP EVM.

The below sequence was followed to run the application:

1. Run the application using the command line with no options specified (default values were used for resolution and frame speed).
2. Wait for the background to be updated. This will be signaled by the output of the application being displayed on the LCD and by the command line printing "Updated background". The background can be updated manually by pressing the 'b' key.
3. Have the subjects walk in front of the camera.

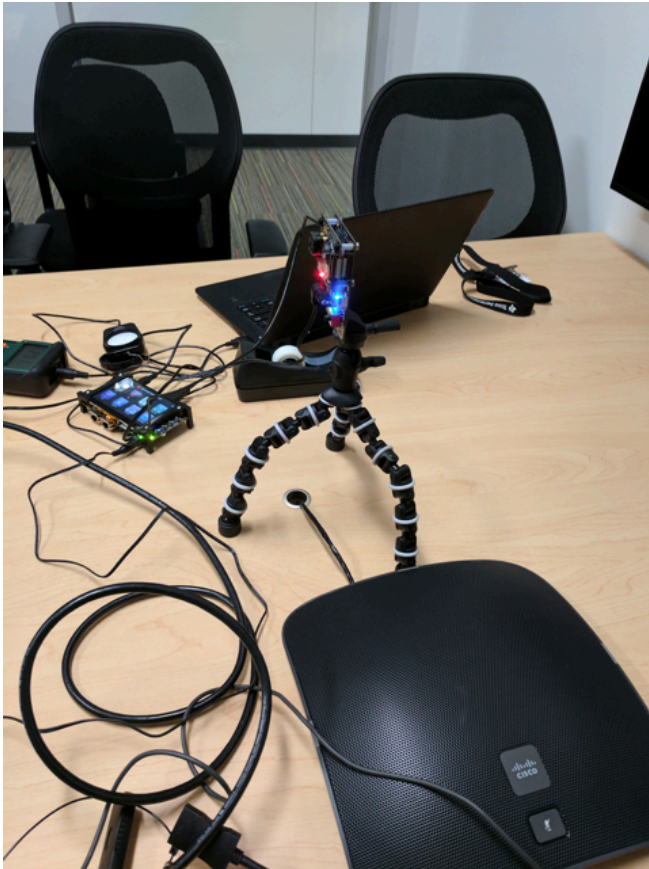

☒ 23. OPT8241 CDK and AM437x GP EVM With Tripod



☒ 24. 3D ToF Functional Test Setup



図 25. Forward View of 3D ToF Camera

注: The pictures of the setup show the AM437x Starter Kit, but this reference design primarily discusses the AM437x GP EVM. Either board can be used in this TI Design.

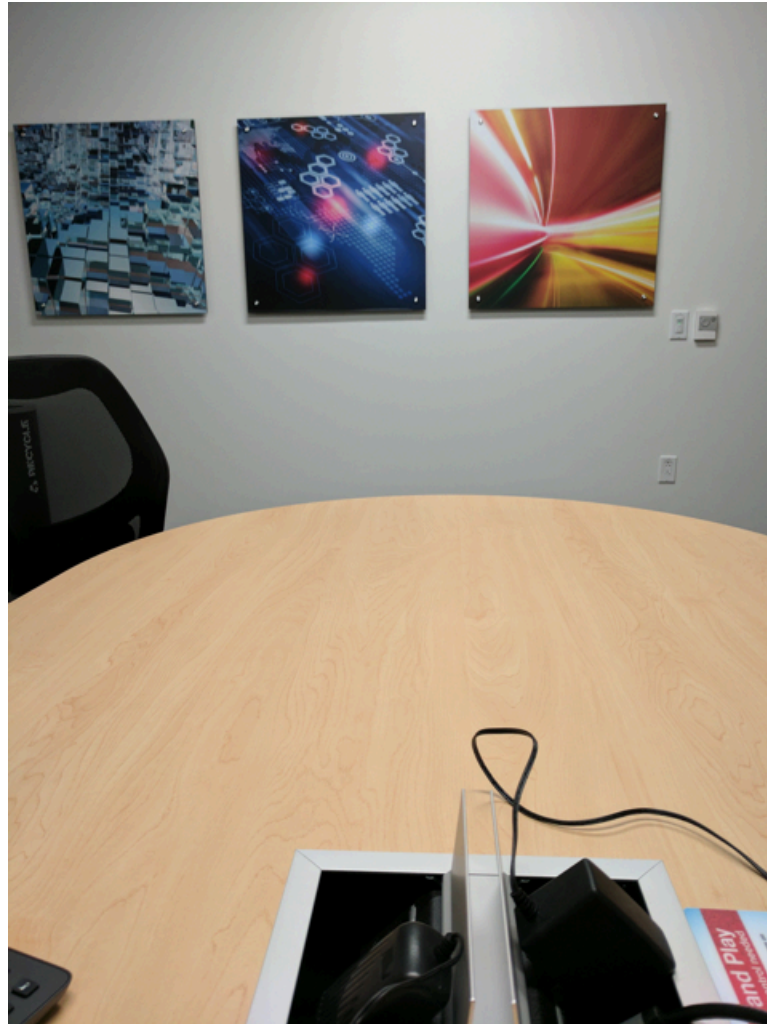

## 5.2 Test Data

注: Unless otherwise noted, the test data in the following sections were measured with the system at room temperature.

All of the measurements in this section were measured with calibrated lab equipment.

### 5.2.1 Frame Size and Frame Rate Performance

Depending on the image processing algorithm, the processor will require a certain amount of time to process and compute each frame. However, if the time needed to read in the frame and run the algorithm requires a long time, the processor will either miss the next frame or read the next frame at a delayed time. Both options are not a desired effect when it comes to real-time people tracking.

For this test, the frame size and frame rate were set to different values in the Simple People Tracking algorithm. The Simple People Tracking terminal output was monitored for 10 seconds to determine if any frames were dropped by the presence of continuous USB error messages.

**表 3. Error Messages Shown in Simple People Tracking at Different Frame Size and Frame Rate**

RESOLUTION	30 FPS	20 FPS	10 FPS
320 x 240	Continuous "USBBulkStreamer: Dropping a frame" error	Continuous "USBBulkStreamer: Dropping a frame" error	No continuous error messages
320 x 120	No continuous error messages	No continuous error messages	No continuous error messages
160 x 240	No continuous error messages	No continuous error messages	No continuous error messages
160 x 120	No continuous error messages	No continuous error messages	No continuous error messages
160 x 60	No continuous error messages	No continuous error messages	No continuous error messages
80 x 120	No continuous error messages	No continuous error messages	No continuous error messages
80 x 60	No continuous error messages	No continuous error messages	No continuous error messages

The results are seen in 表 3. When the camera sensor was configured for a 320x240 frame size at 30 and 20 frames per second, many camera frames were being dropped. All other frame size and rate parameters did not show many errors.

The frames are dropped when the frame rate is high and there is high CPU utilization. 表 4 illustrates this by showing the CPU utilization at different combinations of frame size and frame rate.

**表 4. CPU Utilization at Different Frame Size and Frame Rate**

RESOLUTION	FRAME RATE	CPU UTILIZATION
320 x 240	30 fps	91.2%
320 x 240	20 fps	89.5%
320 x 240	10 fps	87.9%
160 x 120	30 fps	80.1%
160 x 120	20 fps	74.6%
160 x 120	10 fps	43.1%
80 x 60	30 fps	64.9%
80 x 60	20 fps	47.4%
80 x 60	10 fps	27.8%

Because the data was captured by running the Simple People Tracking algorithm, a different or more complex algorithm may cause different results. If the frame size or frame rate is causing video performance issues, the frame rate or frame size can be reduced to lower the time spent during data read.

If a frame rate and frame size is a fixed requirement, there are multiple methods to improve the performance. One method is to bypass the OPT8241 CDK's camera interface to the USB bridge and directly connect the camera interface to the AM437x. However, this requires multiple software changes, which this design guide does not cover. Another method is to select a higher performance processor.

## 5.2.2 Power Characterization

### 5.2.2.1 OPT8241 CDK Power Profile

The test setup for the supply current measurements is illustrated in [図 21](#). The OPT8241 CDK is running with the following conditions:

- 5-V power input
- 60% illumination power
- 20% illumination duty cycle
- Simple People Tracking algorithm

When the OPT8241 CDK is first powered on, the illumination circuit is not on. The initial power consumption is 218 mA.

When the Simple People Tracking algorithm starts, it will initialize the illumination circuit with the parameters defined above. The supply current data is shown in [表 5](#).

**表 5. OPT8241 CDK Active Supply Current**

FRAME SIZE	FRAME RATE	MEASURED CURRENT
320 × 240	30 fps	903 mA
320 × 240	20 fps	898 mA
320 × 240	10 fps	886 mA
160 × 120	30 fps	883 mA
160 × 120	20 fps	882 mA
160 × 120	10 fps	878 mA
80 × 60	30 fps	877 mA
80 × 60	20 fps	877 mA
80 × 60	10 fps	876 mA

The measured active current is relatively higher than initial power consumption. This is due to the illumination circuit and laser being off by default. The power consumption of the illumination circuit can be lessened by reducing the illumination power and duty cycle. However, this will cause a tradeoff in performance, since the laser will not be on as often.

### 5.2.2.2 AM437x GP EVM Power Profile

The test setup for the supply current measurements is illustrated in [Figure 21](#). The EVM is running with the following conditions:

- 5-V power input
- On-demand CPU governor, which will scale the frequency depending on the CPU utilization

When the AM437x GP EVM is powered on but not running any applications, the CPU governor will configure the CPU frequency to 300 MHz. Additionally, only the SD card is connected. All other interfaces are disconnected. At this point, the supply current is at 357 mA.

Prior to running the Simple People Tracking application, the USB cable to the OPT8241 CDK is connected. When the Simple People Tracking application is running, the CPU governor will scale the CPU frequency between 600 to 1000 MHz. The amount of time the CPU is running at 1000 MHz depends on how long it takes the CPU to read the camera data and process the frame using the Simple People Tracking algorithm. Once the CPU has completed the image processing and before the next camera frame arrives, the CPU governor will reduce the CPU frequency down to 600 MHz to conserve power. The supply current data is shown in [Table 6](#).

**表 6. AM437x Active Supply Current**

FRAME SIZE	FRAME RATE	MEASURED CURRENT
320 × 240	30 fps	537 mA
320 × 240	10 fps	532 mA
160 × 120	30 fps	514 mA
160 × 120	10 fps	482 mA
80 × 60	30 fps	493 mA
80 × 60	10 fps	478 mA

Different image processing algorithms may cause different results. As previously mentioned, the longer it takes the CPU to read and process the camera frame, the longer the CPU will stay in the higher power consuming but faster CPU frequency.

### 5.2.2.3 Alternative Methods to Reduce Power Consumption

Additional sensors can be added to the system as a first level detection and to help reduce the overall power consumption. In this scenario, the higher power consuming TFC and host processor can be placed in its lowest power state. The low power external sensor is always on and will trigger the higher power devices to wake up whenever a condition is met. Within the algorithm, a routine can be defined to return the higher power devices back into low power mode whenever it detects no additional objects or see no activity after a predetermined set of time.

Depending on your application, there are multiple low power external sensors that can be added to the system. There are two options. One low power sensor option is the PIR motion detector. Whenever the PIR sensor detects the first motion, it will wake up the higher power devices and start the algorithm to get an accurate count on the number of people. Another option is an ambient light sensor. This sensor is useful in office situations where the lights are usually on when a person is present. The ambient light sensor will monitor when the light reaches a certain brightness threshold. When that occurs, the light sensor will wake up the higher power devices.

## 5.2.3 Functional

### 5.2.3.1 Ambient Light Immunity

The system was tested against three ambient light conditions: full brightness (600 lux), half brightness (300 lux) and no light (0 lux). The test subject stood 8 feet away from the camera. While the Simple People Tracking algorithm is running, the ambient light was changed using the room's wall light dimmer switch. The brightness was measured by placing an Extech light meter (model 407026) near the camera. As seen in the following figures, the light levels do not affect the performance of the ToF system.

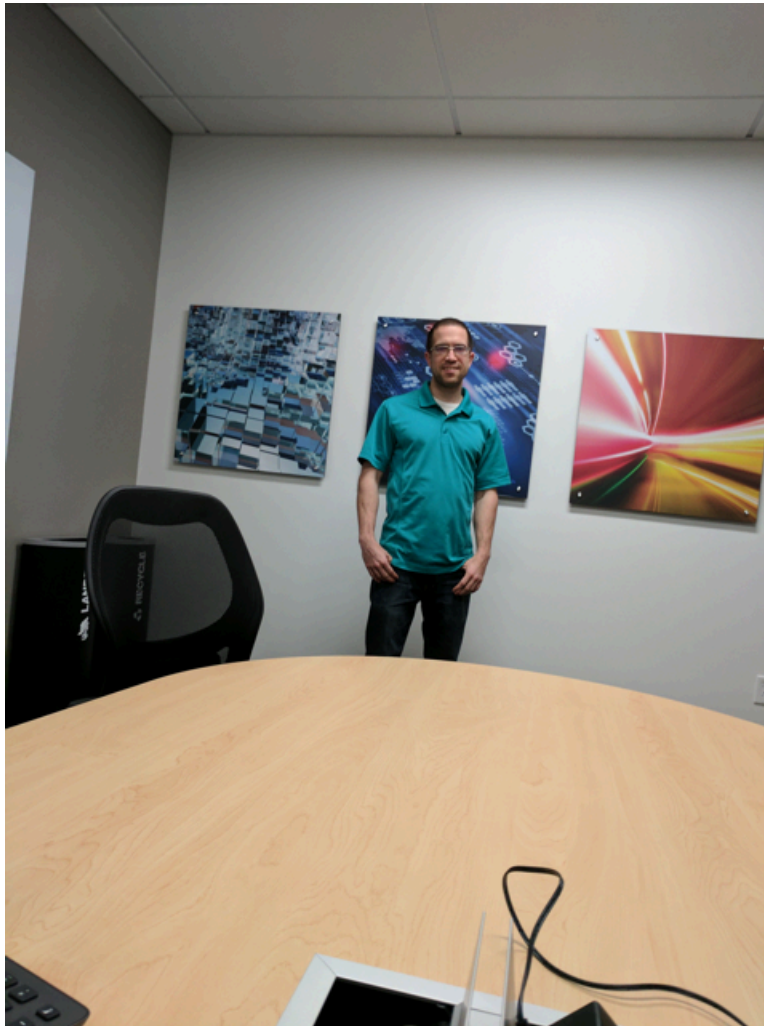

☒ 26. Traditional Camera View

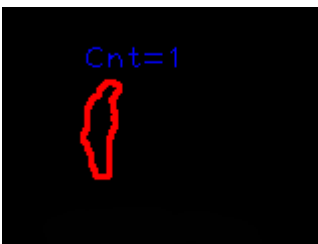

☒ 27. Full Brightness at 600 Lux

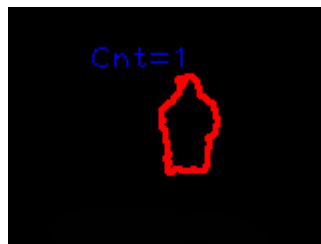

☒ 28. Half Brightness at 300 Lux

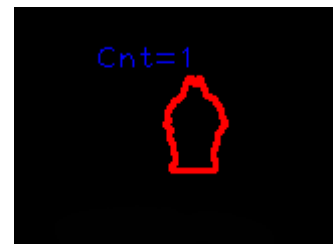

☒ 29. No Light at 0 Lux

### 5.2.3.2 Multiple People

This test shows the Simple People Tracking algorithm ability to detect multiple people. The test setup is described in 5.1.2. Two test subjects were asked to stand in the conference room, but they must not overlap or block each other.



図 30. Traditional Camera View



図 31. Simple People Tracking Algorithm Output

The Simple People Tracking algorithm can successfully detect the foreground objects, but the algorithm also has room for improvement. For example, a more sophisticated foreground-background subtraction ( 3.5.1) or tracking of people entering and exiting the camera view ( 3.5.4) will be able to improve the algorithm by filtering out displaced background objects, as seen by the chair in the above pictures.

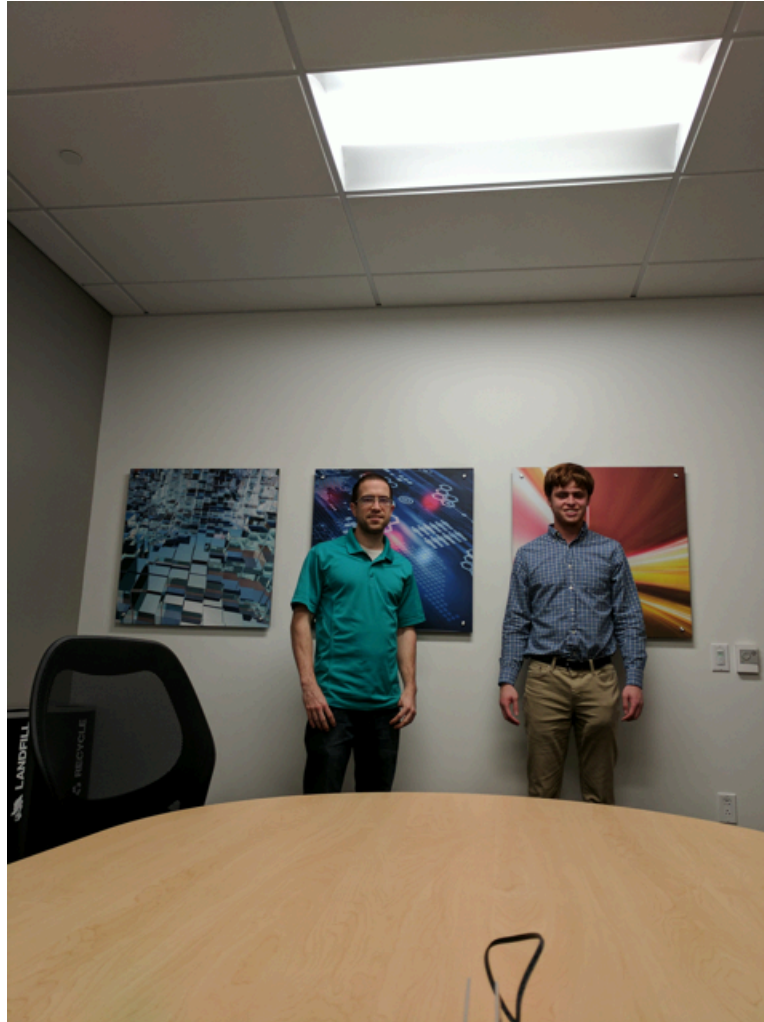
Another area of improvement is how to accurately count objects that are overlapping or blocked by another object. In this test setup, each subject was asked not to overlap or block another test subject. This is due to the implementation of the Simple People Tracking algorithm. As mentioned in Simple People Tracking Algorithm Example, the algorithm uses OpenCV contour functions to draw around the foreground objects. However, if two objects overlap, there will only be one contour that circles both objects. The algorithm does not take into account how to distinguish multiple objects within one contour.

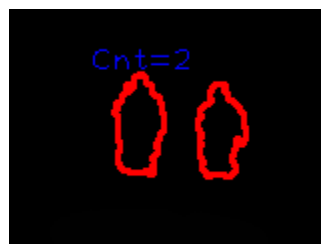

## 6 Design Files

### 6.1 OPT8241-CDK-EVM

Download the design files from <http://www.ti.com/tool/opt8241-cdk-evm>.

### 6.2 TMDSEVM437X

Download the design resources from <http://www.ti.com/tool/tmdsevm437x>.

## 7 Software Files

Download the Processor Linux SDK for the AM437x from <http://www.ti.com/tool/processor-sdk-am437x>.

## 8 Related Documentation

1. Texas Instruments, [Introduction to the Time-of-Flight \(ToF\) System Design](#), ToF User's Guide (SBAU219)
2. Texas Instruments, [Time-of-Flight Camera — An Introduction](#), Technical White Paper (SLOA190)
3. Texas Instruments, [OPT8241 Evaluation Module](#), OPT8241 User's Guide (SBOU155)
4. Texas Instruments, [OPT8241 Evaluation Module](#), OPT8241 Quick Start Guide (SBOU156)
5. Texas Instruments, [OPT8241 3D Time-of-Flight Sensor](#), OPT8241 Datasheet (SBAS704)
6. Texas Instruments, [OPT9221 Time-of-Flight Controller](#), OPT9221 Datasheet (SBAS703)
7. Texas Instruments, [AM437x Sitara™ Processors](#), AM437x Datasheet (SPRS851)
8. Watson, Robin, [Method for Segmentation of Articulated Structures Using Depth Images for Public Displays](#) (PDF)
9. Learn OpenCV, [Blob Detection Using OpenCV \(Python, C++\)](#) (<http://www.learnopencv.com/blob-detection-using-opencv-python-c/>)

### 8.1 商標

Sitara is a trademark of Texas Instruments.

NEON is a trademark of ARM Ltd.

ARM, Cortex are registered trademarks of ARM Ltd.

EtherCAT is a registered trademark of Beckhoff Automation GmbH.

Bluetooth is a registered trademark of Bluetooth SIG.

1-Wire is a registered trademark of Dallas Semiconductor.

PowerVR SGX is a registered trademark of Imagination Technologies Limited.

Linux is a registered trademark of Linus Torvalds.

EtherNet/IP is a trademark of ODVA, Inc.

PROFIBUS, PROFINET are registered trademarks of PROFIBUS and PROFINET International.

Wi-Fi is a registered trademark of Wi-Fi Alliance.

Zigbee is a registered trademark of ZigBee Alliance.

## 9 About the Authors

**CHRISTINA S. LAM** is a systems architect at Texas Instruments, where she is responsible for developing firmware for reference design solutions in the industrial segment. Christina has broad experience with applications processors, microcontrollers, and digital-signal processors with specialties in embedded firmware. Christina earned her bachelor of science (BS) in electrical and computer engineering from the University of Texas at Austin.

**SHARAD YADAV** is a systems engineer at Texas Instruments India, where he is responsible for developing reference design solutions for the industrial segment. Sharad has eight years of experience in high-speed digital, mixed-signal boards, low-noise analog, and EMC protection circuit design.



**NATHAN SIEGEL** is a systems designer at Texas Instruments, where he is responsible for developing reference design solutions for the industrial segment. Nathan earned his bachelor of science (BS) in electrical engineering from the University of California, Los Angeles (UCLA).

## TIの設計情報およびリソースに関する重要な注意事項

Texas Instruments Incorporated ("TI")の技術、アプリケーションその他設計に関する助言、サービスまたは情報は、TI製品を組み込んだアプリケーションを開発する設計者に役立つことを目的として提供するものです。これにはリファレンス設計や、評価モジュールに関する資料が含まれますが、これらに限られません。以下、これらを総称して「TIリソース」と呼びます。いかなる方法であっても、TIリソースのいずれかをダウンロード、アクセス、または使用した場合、お客様(個人、または会社を代表している場合にはお客様の会社)は、これらのリソースをここに記載された目的にのみ使用し、この注意事項の条項に従うことに合意したものとします。

TIによるTIリソースの提供は、TI製品に対する該当の発行済み保証事項または免責事項を拡張またはいかなる形でも変更するものではなく、これらのTIリソースを提供することによって、TIにはいかなる追加義務も責任も発生しないものとします。TIは、自社のTIリソースに訂正、拡張、改良、およびその他の変更を加える権利を留保します。

お客様は、自らのアプリケーションの設計において、ご自身が独自に分析、評価、判断を行う責任がお客様にあり、お客様のアプリケーション(および、お客様のアプリケーションに使用されるすべてのTI製品)の安全性、および該当するすべての規制、法、その他適用される要件への遵守を保証するすべての責任をお客様のみが負うことを理解し、合意するものとします。お客様は、自身のアプリケーションに関して、(1) 故障による危険な結果を予測し、(2) 障害とその結果を監視し、および、(3) 損害を引き起こす障害の可能性を減らし、適切な対策を行う目的で、安全策を開発し実装するために必要な、すべての技術を保持していることを表明するものとします。お客様は、TI製品を含むアプリケーションを使用または配布する前に、それらのアプリケーション、およびアプリケーションに使用されているTI製品の機能性を完全にテストすることに合意するものとします。TIは、特定のTIリソース用に発行されたドキュメントで明示的に記載されているもの以外のテストを実行していません。

お客様は、個別のTIリソースにつき、当該TIリソースに記載されているTI製品を含むアプリケーションの開発に関連する目的でのみ、使用、コピー、変更することが許可されています。明示的または黙示的を問わず、禁反言の法理その他どのような理由でも、他のTIの知的所有権に対するその他のライセンスは付与されません。また、TIまたは他のいかなる第三者のテクノロジーまたは知的所有権についても、いかなるライセンスも付与されるものではありません。付与されないものには、TI製品またはサービスが使用される組み合わせ、機械、プロセスに関連する特許権、著作権、回路配置利用権、その他の知的所有権が含まれますが、これらに限られません。第三者の製品やサービスに関する、またはそれらを参照する情報は、そのような製品またはサービスを利用するライセンスを構成するものではなく、それらに対する保証または推奨を意味するものでもありません。TIリソースを使用するため、第三者の特許または他の知的所有権に基づく第三者からのライセンス、あるいはTIの特許または他の知的所有権に基づくTIからのライセンスが必要な場合があります。

TIのリソースは、それに含まれるあらゆる欠陥も含めて、「現状のまま」提供されます。TIは、TIリソースまたはその仕様に関して、明示的か暗黙的にかかわらず、他のいかなる保証または表明も行いません。これには、正確性または完全性、権原、続発性の障害に関する保証、および商品性、特定目的への適合性、第三者の知的所有権の非侵害に対する黙示的保証が含まれますが、これらに限られません。

TIは、いかなる苦情に対しても、お客様への弁済または補償を行う義務はなく、行わないものとします。これには、任意の製品の組み合わせに関連する、またはそれらに基づく侵害の請求も含まれますが、これらに限られず、またその事実についてTIリソースまたは他の場所に記載されているか否かを問わないものとします。いかなる場合も、TIリソースまたはその使用に関連して、またはそれらにより発生した、実際の、直接的、特別、付随的、間接的、懲罰的、偶発的、または、結果的な損害について、そのような損害の可能性についてTIが知らされていたかどうかにかかわらず、TIは責任を負わないものとします。

お客様は、この注意事項の条件および条項に従わなかったために発生した、いかなる損害、コスト、損失、責任からも、TIおよびその代表者を完全に免責するものとします。

この注意事項はTIリソースに適用されます。特定の種類の資料、TI製品、およびサービスの使用および購入については、追加条項が適用されます。これには、半導体製品(<http://www.ti.com/sc/docs/stdterms.htm>)、評価モジュール、およびサンプル(<http://www.ti.com/sc/docs/sampterm.htm>)についてのTIの標準条項が含まれますが、これらに限られません。