

LM7600x-Q1 3.5V~60V、2.5A/3.5A 同期整流 降圧型電圧レギュレータ

1 特長

- 車載アプリケーション用に AEC-Q100 認定済み
 - デバイス温度グレード 1: 動作時周囲温度 -40°C~+125°C
 - デバイス HBM ESD 分類レベル 2
 - デバイス CDM ESD 分類レベル C5
- 同期整流器内蔵
- 入力電圧: 3.5V~60V (最大値 65V)
- 出力電圧: 1V から V_{IN} の 95% まで
- レギュレーション時の静止電流: 15µA
- 広い電圧変換範囲
 - $t_{ON-MIN} = 65ns$ (標準値)
 - $t_{OFF-MIN} = 95ns$ (標準値)
- システム・レベルの特長
 - 外部クロックへの同期
 - パワー・グッド・フラグ
 - 可変ソフトスタート (デフォルト 6.3ms)
- FPWM 動作をピンで選択可能
- 可変周波数範囲: 300kHz~2.2MHz
- 軽負荷時に効率の高いアーキテクチャ (PFM)
- 保護機能
 - サイクル単位の電流制限
 - ヒカップ・モードによる短絡保護
 - 過熱時のサーマル・シャットダウン保護
- LM76002-Q1/LM76003-Q1 を使用するカスタム設計を **WEBENCH® Power Designer** により作成

2 アプリケーション

- 市販車用カメラ・アプリケーション
- インフォテインメント/クラスタ
- ハイブリッド電気自動車
- 電気自動車 (EV)

概略回路図

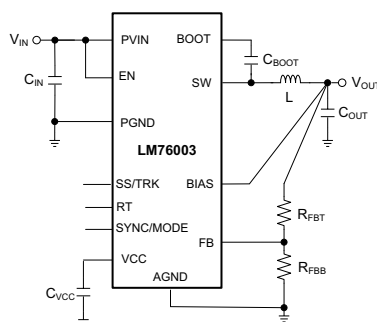

3 概要

LM76002-Q1/LM76003-Q1 レギュレータは、最大 60V の入力から最大 2.5 A (LM76002-Q1) または 3.5 A (LM76003-Q1) の負荷電流を駆動できる使いやすい同期整流降圧型 DC-DC コンバータです。LM76002-Q1/LM76003-Q1 は、非常に小さいソリューション・サイズで非常に高い効率と出力精度を実現します。ピーク電流モード制御が採用されています。スイッチング周波数の設定、同期、FPWM オプション、パワー・グッド・フラグ、高精度のイネーブル、可変ソフトスタート、トラッキングなどの追加機能により、広範なアプリケーションに対して柔軟で使いやすいソリューションを実現できます。軽負荷時の自動周波数フォールドバックと、オプションの外部バイアスにより、効率が向上します。このデバイスは、必要な外付けコンポーネントが少なく、PCB レイアウトが単純になるようにピン配置が設計されており、クラス最高の EMI (CISPR25) および熱性能を実現しています。保護機能として、入力低電圧誤動作防止、サーマル・シャットダウン、サイクル単位の電流制限、短絡保護が搭載されています。LM76002-Q1/LM76003-Q1 デバイスは、ウェットプル・フランク付きの WQFN 30 ピン・リードレス・パッケージで供給されます。

製品情報⁽¹⁾

型番	パッケージ	本体サイズ(公称)
LM76002-Q1	WQFN (30)	6.00mm×4.00mm
LM76003-Q1		

(1) 提供されているすべてのパッケージについては、このデータシートの末尾にある注文情報を参照してください。

効率と出力電流との関係
($V_{OUT}=5V$ 、 $f_{sw}=400kHz$ 、自動モード)

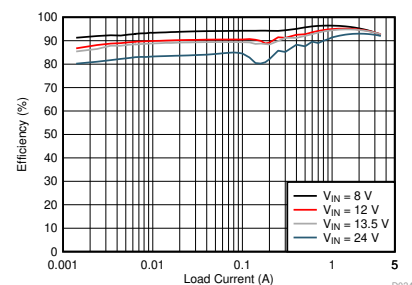

0034



目次

1	特長	1	7.3	Feature Description	13
2	アプリケーション	1	7.4	Device Functional Modes	22
3	概要	1	8	Application and Implementation	24
4	改訂履歴	2	8.1	Application Information	24
5	Pin Configuration and Functions	3	8.2	Typical Applications	24
6	Specifications	5	9	Power Supply Recommendations	42
6.1	Absolute Maximum Ratings	5	10	Layout	42
6.2	ESD Ratings	5	10.1	Layout Guidelines	42
6.3	Recommended Operating Conditions	5	10.2	Layout Example	45
6.4	Thermal Information	6	10.3	Thermal Design	46
6.5	Electrical Characteristics	6	11	デバイスおよびドキュメントのサポート	47
6.6	Timing Characteristics	8	11.1	デバイス・サポート	47
6.7	Switching Characteristics	8	11.2	ドキュメントの更新通知を受け取る方法	47
6.8	System Characteristics	9	11.3	サポート・リソース	47
6.9	Typical Characteristics	10	11.4	商標	47
7	Detailed Description	12	11.5	静電気放電に関する注意事項	47
7.1	Overview	12	11.6	Glossary	47
7.2	Functional Block Diagram	12	12	メカニカル、パッケージ、および注文情報	47

4 改訂履歴

Revision A (November 2018) から Revision B に変更

Page

• Updated the Thermal Information table	6
• Changed 図 17	18
• Updated Power Good and Overvoltage Protection (PGOOD) section	20

5 Pin Configuration and Functions

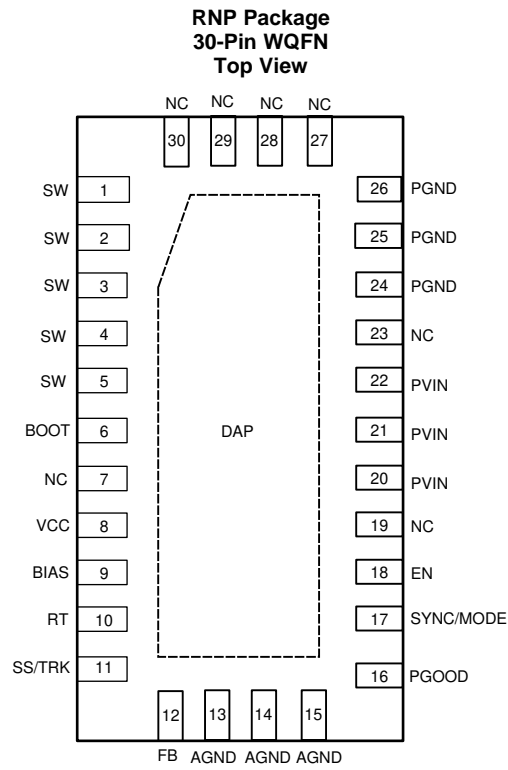

Pin Functions

PIN		I/O ⁽¹⁾	DESCRIPTION
NO.	NAME		
1, 2, 3, 4, 5	SW	P	Switching output of the regulator. Internally connected to source of the HS FET and drain of the LS FET. Connect to power inductor and boot-strap capacitor.
6	BOOT	P	Boot-strap capacitor connection for high-side driver. Connect a high-quality 470-nF capacitor from this pin to the SW pin.
7, 19, 23, 27, 28, 29, 30	NC	—	Not internally connected. Connect to ground copper on PCB to improve heat-sinking of the device and board level reliability.
8	VCC	P	Output of internal bias supply. Used as supply to internal control circuits. Connect a high-quality 2.2- μ F capacitor from this pin to GND. TI does not recommended loading this pin by external circuitry.
9	BIAS	P	Optional BIAS LDO supply input. TI recommends tying this to V_{OUT} when $3.3\text{ V} \leq V_{OUT} \leq 18\text{ V}$, or tying to an external 3.3-V or 5-V rail if available, to improve efficiency. When used, place a 1- μ F capacitor from this terminal to ground. Tie to ground when not in use.
10	RT	A	Switching frequency setting pin. Place a resistor from this pin to ground to set the switching frequency. If floating, the default switching frequency is 500 kHz. Do not short to ground.
11	SS/TRK	A	Soft-start-control pin. Leave this pin floating to use the 6.3-ms internal soft-start ramp. An external capacitor can be connected from this pin to ground to extend the soft-start time. A 2- μ A current sourced from this pin can charge the capacitor to provide the ramp. Connect to external ramp for tracking. Do not short to ground.
12	FB	A	Feedback input for output voltage regulation. Connect a resistor divider to set the output voltage. Never short this terminal to ground during operation.
16	PGOOD	A	Open-drain power-good flag output. Connect to suitable voltage supply through a current limiting resistor. High = V_{OUT} regulation OK, Low = V_{OUT} regulation fault. PGOOD = Low when EN = Low.
17	SYNC/MODE	A	Synchronization input and mode setting pin. Do not float, tie to ground if not used. Tie to ground: DCM/PFM operation under light loads, improved efficiency; tie to logic high: forced PWM under light loads, constant switching frequency over load; tie to external clock source: synchronize switching action to the clock, forced PWM under light loads. Triggers on the rising edge of external clock.
18	EN	A	Precision-enable input to regulator. Do not float. High = on, Low = off. Can be tied to V_{IN} . Precision-enable input allows adjustable UVLO by external resistor divider.
13, 14, 15	AGND	G	Analog ground. Ground reference for internal references and logic. All electrical parameters are measured with respect to this pin. Connect to system ground on PCB.
20, 21, 22	PVIN	P	Supply input to internal bias LDO and HS FET. Connect to input supply and input bypass capacitors C_{IN} . C_{IN} must be placed right next to this pin and PGND and connected with short traces.
24, 25, 26	PGND	G	Power ground, connected to the source of LS FET internally. Connect to system ground, DAP/EP, AGND, ground side of C_{IN} and C_{OUT} . Path to C_{IN} must be as short as possible.
EP	DAP	—	Low impedance connection to AGND. Connect to system ground on PCB. Major heat dissipation path for the die. Must be used for heat sinking by soldering to ground copper on PCB. Thermal vias are preferred.

(1) A = Analog, O = Output, I = Input, G = Ground, P = Power

6 Specifications

6.1 Absolute Maximum Ratings

over operating free-air temperature range of -40°C to $+125^{\circ}\text{C}$ (unless otherwise noted)⁽¹⁾

	PARAMETER	MIN	MAX	UNIT
Input voltages	PVIN to PGND	-0.3	65	V
	EN to AGND	-0.3	$V_{\text{IN}} + 0.3$	
	FB, RT, SS/TRK to AGND	-0.3	5	
	PGOOD to AGND	-0.1	20	
	SYNC to AGND	-0.3	5.5	
	BIAS to AGND	-0.3	Lower of $(V_{\text{IN}} + 0.3)$ or 30	
	AGND to PGND	-0.3	0.3	
Output voltages	SW to PGND	-0.3	$V_{\text{IN}} + 0.3$	V
	SW to PGND less than 10-ns transients	-3.5	65	
	BOOT to SW	-0.3	5.5	
	VCC to AGND	-0.3	5.5	
Junction temperature, T_{J}		-40	150	$^{\circ}\text{C}$
Storage temperature, T_{stg}		-65	150	$^{\circ}\text{C}$

(1) Stresses beyond those listed under *Absolute Maximum Ratings* may cause permanent damage to the device. These are stress ratings only, which do not imply functional operation of the device at these or any other conditions beyond those indicated under *Recommended Operating Conditions*. Exposure to absolute-maximum-rated conditions for extended periods may affect device reliability.

6.2 ESD Ratings

			VALUE	UNIT
$V_{\text{(ESD)}}$	Electrostatic discharge	Human-body model (HBM), per AEC Q100-002 ⁽¹⁾	± 2000	V
		Charged-device model (CDM), per AEC Q100-011	± 750	V

(1) AEC Q100-002 indicates that HBM stressing shall be in accordance with the ANSI/ESDA/JEDEC JS-001 specification.

6.3 Recommended Operating Conditions

over operating free-air temperature range (unless otherwise noted)⁽¹⁾

		MIN	MAX	UNIT
Input voltages	PVIN to PGND	3.5	60	V
	EN	0	V_{IN}	
	FB	0	4.5	
	PGOOD	0	18	
	BIAS input not used	0	0.3	
	BIAS input used	0	Lower of $(V_{\text{IN}} + 0.3)$ or 24	
	AGND to PGND	-0.1	0.1	
Output voltage	V_{OUT}	1	95% of V_{IN}	V
Output current	I_{OUT} , LM76002-Q1	0	2.5	A
	I_{OUT} , LM76003-Q1	0	3.5	

(1) Recommended operating rating indicate conditions for which the device is intended to be functional, but do not ensure specific performance limits. For ensured specifications, see [Electrical Characteristics](#).

6.4 Thermal Information

THERMAL METRIC ⁽¹⁾		LM76002/LM76003	UNIT
		RNP (WQFN)	
		30 PINS	
$R_{\theta JA}$	Junction-to-ambient thermal resistance	29.6	°C/W
$R_{\theta JC(top)}$	Junction-to-case (top) thermal resistance	17.6	°C/W
$R_{\theta JB}$	Junction-to-board thermal resistance	9.1	°C/W
ψ_{JT}	Junction-to-top characterization parameter	0.2	°C/W
ψ_{JB}	Junction-to-board characterization parameter	9.0	°C/W
$R_{\theta JC(bot)}$	Junction-to-case (bottom) thermal resistance	1.0	°C/W

(1) For more information about traditional and new thermal metrics, see the [Semiconductor and IC Package Thermal Metrics](#) application report.

6.5 Electrical Characteristics

Limits apply over the recommended operating junction temperature (T_J) range of -40°C to $+125^{\circ}\text{C}$, unless otherwise stated. Minimum and maximum limits are specified through test, design, or statistical correlation. Typical values represent the most likely parametric norm at $T_J = 25^{\circ}\text{C}$, and are provided for reference purposes only. Unless otherwise stated, the following conditions apply: $V_{IN} = 24\text{ V}$.

PARAMETER	TEST CONDITIONS	MIN	TYP	MAX	UNIT	
SUPPLY VOLTAGE (PVIN PINS)						
V_{IN}	Operating input voltage range	3.5		60	V	
I_{SD}	Shutdown quiescent current; measured at PVIN pin ⁽¹⁾	$V_{EN} = 0\text{ V}$ $T_J = 25^{\circ}\text{C}$	1.2	10	μA	
I_{Q_NONSW}	Operating quiescent current from V_{IN} (non-switching)	$V_{EN} = 2\text{ V}$, $V_{FB} = 1.5\text{ V}$, $V_{BIAS} = 3.3\text{ V}$ external	0.9	12	μA	
ENABLE (EN PIN)						
$V_{EN_VCC_H}$	Enable input high level for V_{CC} output	V_{EN} rising		1.2	V	
$V_{EN_VCC_L}$	Enable input low level for V_{CC} output	V_{EN} falling	0.3		V	
$V_{EN_VOUT_H}$	Enable input high level for V_{OUT}	V_{EN} rising	1.14	1.204	1.25	V
$V_{EN_VOUT_HYS}$	Enable input hysteresis for V_{OUT}	V_{EN} falling hysteresis	-150		mV	
I_{LKG_EN}	Enable input leakage current	$V_{EN} = 2\text{ V}$	1.4	200	nA	
INTERNAL LDO (VCC PIN, BIAS PIN)						
V_{CC}	Internal V_{CC} voltage	PWM operation		3.29	V	
		PFM operation		3.1	V	
V_{CC_UVLO}	Internal V_{CC} undervoltage lockout	V_{CC} rising	2.96	3.14	3.27	V
		V_{CC} falling hysteresis		-565		mV
V_{BIAS_ON}	Input changeover	V_{BIAS} rising		3.11	3.25	V
		V_{BIAS} falling hysteresis		-63		mV
I_{BIAS_NONSW}	Operating quiescent current from external V_{BIAS} (non-switching)	$V_{EN} = 2\text{ V}$, $V_{FB} = 1.5\text{ V}$, $V_{BIAS} = 3.3\text{ V}$ external	21	50	μA	
VOLTAGE REFERENCE (FB PIN)						
V_{FB}	Feedback voltage	PWM mode	0.987	1.006	1.017	V
I_{LKG_FB}	Input leakage current at FB pin	$V_{FB} = 1\text{ V}$		0.2	60	nA

(1) Shutdown current includes leakage current of the switching transistors.

Electrical Characteristics (continued)

Limits apply over the recommended operating junction temperature (T_J) range of -40°C to $+125^{\circ}\text{C}$, unless otherwise stated. Minimum and maximum limits are specified through test, design, or statistical correlation. Typical values represent the most likely parametric norm at $T_J = 25^{\circ}\text{C}$, and are provided for reference purposes only. Unless otherwise stated, the following conditions apply: $V_{IN} = 24\text{ V}$.

PARAMETER	TEST CONDITIONS	MIN	TYP	MAX	UNIT	
HIGH SIDE DRIVER (BOOT PIN)						
$V_{\text{BOOT_UVLO}}$	BOOT - SW undervoltage lockout	1.6	2.2	2.7	V	
CURRENT LIMITS AND HICCUP						
$I_{\text{HS_LIMIT}}^{(2)}$	Short-circuit, high-side current limit	LM76002-Q1	3.2	4.2	5.3	A
		LM76003-Q1	4.35	5.5	6.8	
$I_{\text{LS_LIMIT}}^{(2)}$	Low-side current limit	LM76002-Q1	2.3	3.2	4.2	A
		LM76003-Q1	3.4	4.2	5.3	
$I_{\text{NEG_LIMIT}}$	Negative current limit	LM76002-Q1		-2.5		A
		LM76003-Q1		-3.3		
V_{HICCUP}	Hiccup threshold on FB pin	0.38	0.42	0.46	V	
$I_{\text{L_ZC}}$	Zero cross-current limit		0.05		A	
SOFT START (SS/TRK PIN)						
I_{SSC}	Soft-start charge current	1.8	2	2.2	μA	
R_{SSD}	Soft-start discharge resistance	UVLO, TSD, OCP; or EN = 0 V		2	k Ω	
POWER GOOD (PGOOD PIN) and OVERVOLTAGE PROTECTION						
$V_{\text{PGOOD_OV}}$	Power-good overvoltage threshold	% of FB voltage	106%	110%	113%	
$V_{\text{PGOOD_UV}}$	Power-good undervoltage threshold	% of FB voltage	86%	90%	93%	
$V_{\text{PGOOD_HYS}}$	Power-good hysteresis	% of FB voltage	2.5%			
$V_{\text{PGOOD_VALID}}$	Minimum input voltage for proper PGOOD function	50- μA pullup to PGOOD pin, $V_{\text{EN}} = 0\text{ V}$, $T_J = 25^{\circ}\text{C}$		1.3	2	V
R_{PGOOD}	Power-good on-resistance	$V_{\text{EN}} = 2.5\text{ V}$		40	100	Ω
		$V_{\text{EN}} = 0\text{ V}$		30	90	
MOSFETS						
$R_{\text{DS_ON_HS}}^{(3)}$	High-side MOSFET on-resistance	$I_{\text{OUT}} = 1\text{ A}$, $V_{\text{BIAS}} = V_{\text{OUT}} = 3.3\text{ V}$		95	150	m Ω
$R_{\text{DS_ON_LS}}^{(3)}$	Low-side MOSFET on-resistance	$I_{\text{OUT}} = 1\text{ A}$, $V_{\text{BIAS}} = V_{\text{OUT}} = 3.3\text{ V}$		45	85	m Ω
THERMAL SHUTDOWN						
$T_{\text{SD}}^{(4)}$	Thermal shutdown threshold	Shutdown threshold		160	$^{\circ}\text{C}$	
	Recovery threshold			135		

(2) This current limit was measured as the internal comparator trip point. Due to inherent delays in the current limit comparator and drivers, the peak current limit measured in closed loop with faster slew rate will be larger, and valley current limit will be lower.

(3) Measured at pins.

(4) Ensured by design.

6.6 Timing Characteristics

			MIN	NOM	MAX	UNIT
CURRENT LIMITS AND HICCUP						
N_{OC} ⁽¹⁾	Number of switching cycles before hiccup is tripped			128		Cycles
t_{OC}	Overcurrent hiccup retry delay time			46		ms
SOFT START (SS/TRK PIN)						
t_{SS}	Internal soft-start time	CSS = OPEN, from EN rising edge to PGOOD rising edge	3.5	6.3		ms
POWER GOOD (PGOOD PIN) and OVERVOLTAGE PROTECTION						
t_{PGOOD_RISE}	PGOOD rising edge deglitch delay		80	140	200	μ s
t_{PGOOD_FALL}	PGOOD falling edge deglitch delay		80	140	200	μ s

(1) Ensured by design.

6.7 Switching Characteristics

PARAMETER		TEST CONDITIONS	MIN	TYP	MAX	UNIT
PWM LIMITS (SW PINS)						
t_{ON-MIN}	Minimum switch on-time			65	95	ns
$t_{OFF-MIN}$	Minimum switch off-time			95	130	ns
t_{ON-MAX}	Maximum switch on-time	HS timeout in dropout	3.8	8	11.4	μ s
OSCILLATOR (RT and SYNC PINS)						
f_{OSC}	Internal oscillator frequency	$R_T = \text{Open}$	440	500	560	kHz
f_{ADJ}	Minimum adjustable frequency by R_T or SYNC	$R_T = 133 \text{ k}\Omega, 0.1\%$	270	300	330	kHz
	Maximum adjustable frequency by R_T or SYNC	$R_T = 17.4 \text{ k}\Omega, 0.1\%$	1980	2200	2420	
V_{SYNC_HIGH}	Sync input high level threshold				2	V
V_{SYNC_LOW}	Sync input low level threshold		0.4			V
V_{MODE_HIGH}	Mode input high level threshold for FPWM			0.42		V
V_{MODE_LOW}	Mode input low level threshold for AUTO mode			0.4		V
t_{SYNC_MIN}	Sync input minimum on- and off-time			80		ns

6.8 System Characteristics

The following specifications apply to the circuit found in the typical [Simplified Schematic](#) with appropriate modifications (see [表 2](#)). These parameters are not tested in production and represent typical performance only. Unless otherwise stated the following conditions apply: $T_A = 25^\circ\text{C}$, $V_{IN} = 24\text{ V}$, $V_{OUT} = 3.3\text{ V}$, $f_{SW} = 500\text{ kHz}$.

PARAMETER		TEST CONDITIONS	MIN	TYP	MAX	UNIT
V_{FB_PFM}	Output voltage offset at no load in auto mode	$V_{IN} = 3.8\text{ V to }36\text{ V}$, $V_{SYNC} = 0\text{ V}$, auto mode $I_{OUT} = 0\text{ A}$		2%		
V_{drop}	Minimum input to output voltage differential to maintain specified accuracy	$V_{OUT} = 5\text{ V}$, $I_{OUT} = 1.5\text{ A}$, $f_{SW} = 2.2\text{ MHz}$		0.4		V
I_{Q_SW}	Operating quiescent current (switching)	$V_{EN} = 3.3\text{ V}$, $I_{OUT} = 0\text{ A}$, $R_T = \text{open}$, $V_{BIAS} = V_{OUT} = 3.3\text{ V}$, $R_{FBT} = 1\text{ Meg}$		15		μA
I_{PEAK_MIN}	Minimum inductor peak current	LM76002-Q1: $V_{SYNC} = 0\text{ V}$, $I_{OUT} = 10\text{ mA}$		0.5		A
		LM76003-Q1: $V_{SYNC} = 0\text{ V}$, $I_{OUT} = 10\text{ mA}$		0.7		
I_{BIAS_SW}	Operating quiescent current from external V_{BIAS} (switching)	$f_{SW} = 500\text{ kHz}$, $I_{OUT} = 1\text{ A}$		7		mA
		$f_{SW} = 2.2\text{ MHz}$, $I_{OUT} = 1\text{ A}$		25		
D_{MAX}	Maximum switch duty cycle	While in frequency foldback	97.5%			
t_{DEAD}	Dead time between high-side and low-side MOSFETs			4		ns

6.9 Typical Characteristics

Unless otherwise specified, $V_{IN} = 24\text{ V}$. Curves represent most likely parametric norm at specified condition.

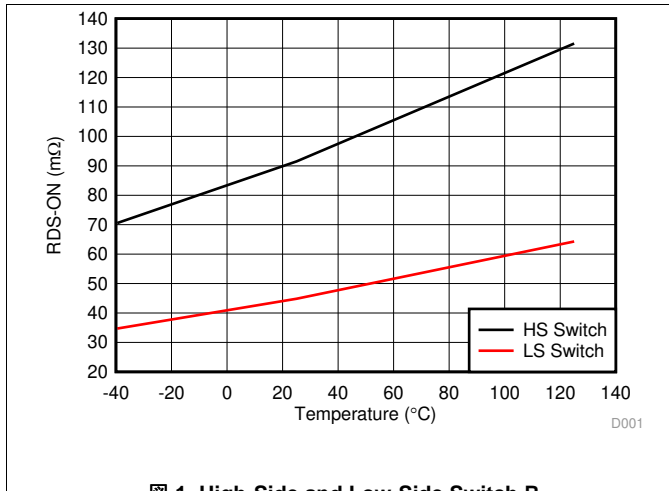

Figure 1. High-Side and Low-Side Switch R_{DS-ON}

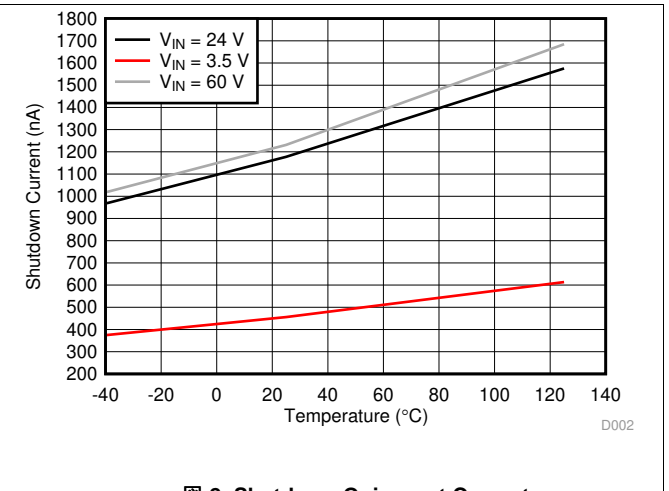

Figure 2. Shutdown Quiescent Current

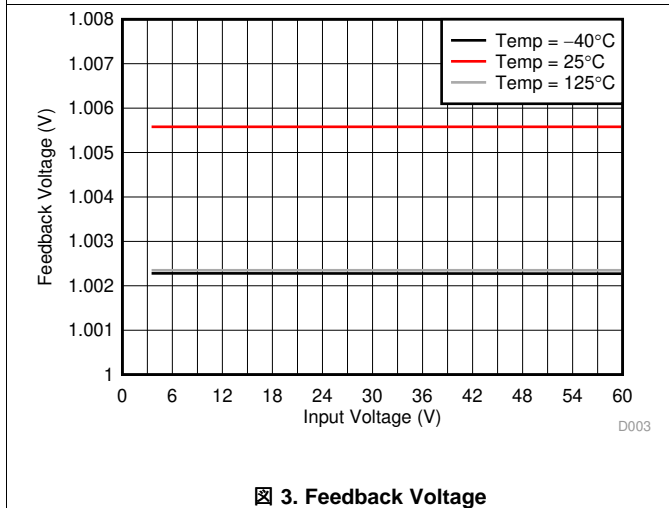

Figure 3. Feedback Voltage

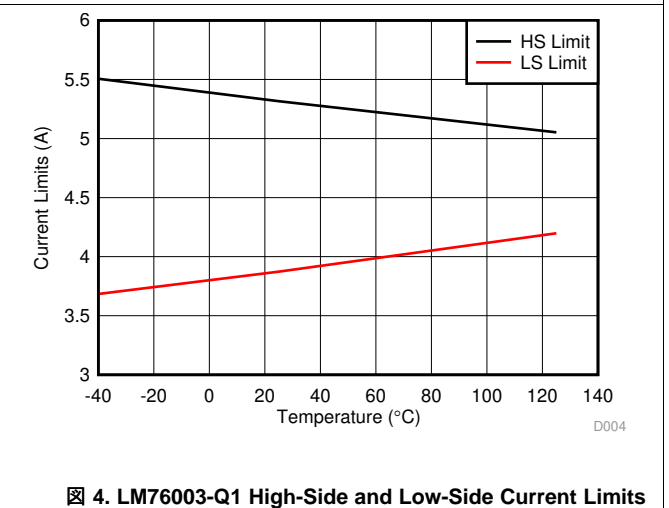

Figure 4. LM76003-Q1 High-Side and Low-Side Current Limits

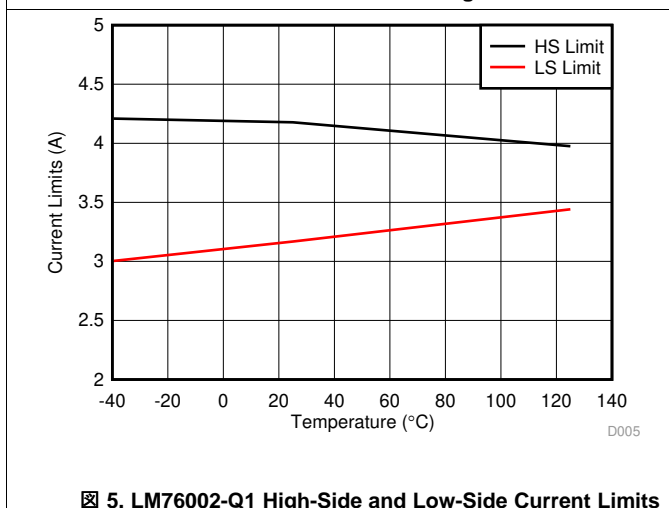

Figure 5. LM76002-Q1 High-Side and Low-Side Current Limits

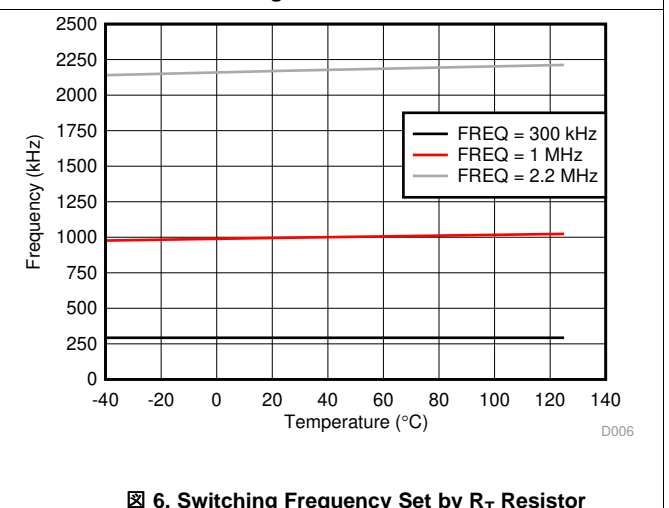

Figure 6. Switching Frequency Set by R_T Resistor

Typical Characteristics (continued)

Unless otherwise specified, $V_{IN} = 24\text{ V}$. Curves represent most likely parametric norm at specified condition.



图 7. Switching Frequency With R_T Open



图 8. Enable Threshold

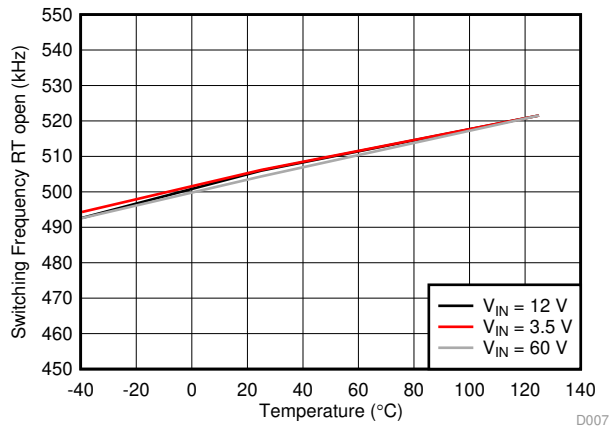

图 9. PGOOD Threshold

7 Detailed Description

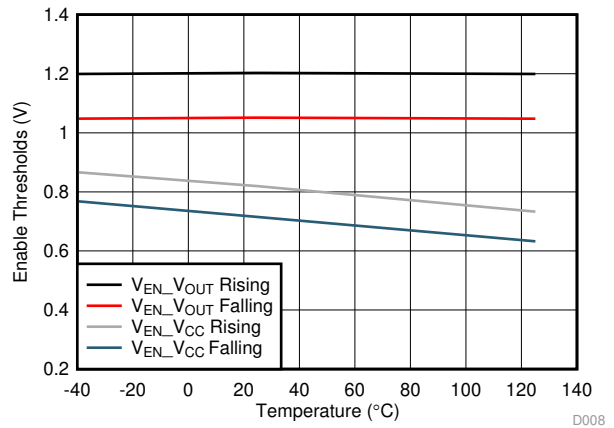
7.1 Overview

The LM76002-Q1/LM76003-Q1 regulator is an easy-to-use synchronous step-down DC-DC converter that operates from 3.5-V to 60-V supply voltage. The device is capable of delivering up to 2.5-A or 3.5-A DC load current with exceptional efficiency and thermal performance in a very small solution size.

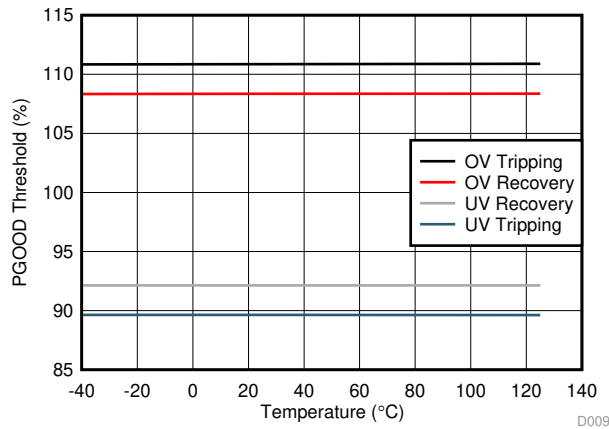
The LM76002-Q1/LM76003-Q1 employs fixed-frequency peak-current-mode control with configurable discontinuous conduction mode (DCM) and pulse frequency modulation (PFM) mode at light load to achieve high efficiency across the load range. The device can also be configured as forced-PWM (FPWM) operation to keep constant switching frequency over the load range. The device is internally compensated, which reduces design time and requires fewer external components. The switching frequency is programmable from 300 kHz to 2.2 MHz by an external resistor. The LM76002-Q1/LM76003-Q1 is also capable of synchronization to an external clock operating within the 300-kHz to 2.2-MHz frequency range. The wide switching frequency range allows the device to meet a wide range of design requirements. It can be optimized to very small solution size with higher frequency or to very high efficiency with lower switching frequency. It has very small minimum HS MOSFET on-time (t_{ON-MIN}) and minimum off-time ($t_{OFF-MIN}$) to provide wide range of voltage conversion. Automated frequency foldback is employed under t_{ON-MIN} or $t_{OFF-MIN}$ condition to further extend the operation range.

The LM76002-Q1/LM76003-Q1 also features a power-good (PGOOD) flag, precision enable, internal or adjustable soft-start rate, start-up with pre-bias voltage, and output voltage tracking. It provides a both flexible and easy-to-use solution for wide range of applications. Protection features include thermal shutdown, V_{CC} undervoltage lockout, cycle-by-cycle current limiting, and short-circuit hiccup protection.

The family requires very few external components and has a pinout designed for simple, optimum PCB layout for EMI and thermal performance. The LM76002-Q1/LM76003-Q1 device is available in a 30-pin WQFN lead-less package.

7.2 Functional Block Diagram

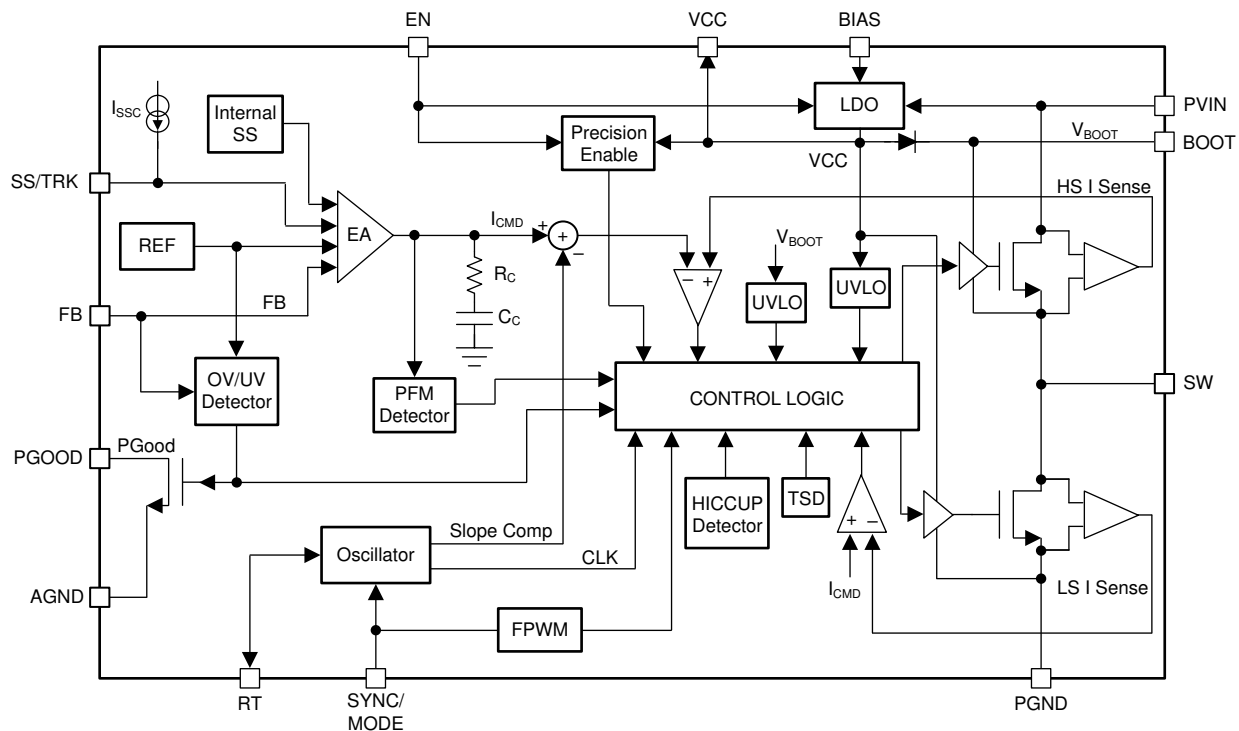

7.3 Feature Description

7.3.1 Fixed-Frequency, Peak-Current-Mode Control

The following operation description of the LM76002-Q1/LM76003-Q1 refers to the [Functional Block Diagram](#) and to the waveforms in [Figure 10](#). The LM76002-Q1/LM76003-Q1 supplies a regulated output voltage by turning on the internal high side (HS) and low side (LS) NMOS switches with varying duty cycle (D). During high-side switch on-time t_{ON} , the SW pin voltage V_{SW} swings up to approximately V_{IN} , and the inductor current i_L increase with linear slope. The HS switch is off by the control logic. During the HS switch off-time, t_{OFF} , the LS switch is turned on. Inductor current discharges through the LS switch, which forces the V_{SW} to swing below ground by the voltage drop across the LS switch. The regulator loop adjusts the duty cycle to maintain a constant output voltage. The control parameter of buck converter is defined as duty cycle $D = t_{ON} / t_{SW}$. In an ideal buck converter, where losses are ignored, D is proportional to the output voltage and inversely proportional to the input voltage: $D = V_{OUT} / V_{IN}$.

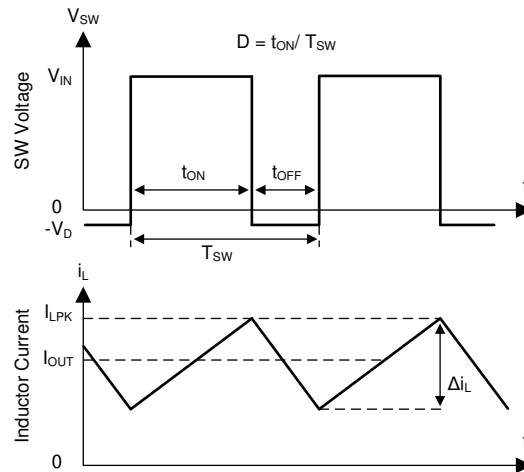

Figure 10. SW Node and Inductor Current Waveforms in Continuous Conduction Mode

The LM76002-Q1/LM76003-Q1 synchronous buck converter employs peak current-mode control topology. A voltage-feedback loop is used to get accurate DC-voltage regulation by adjusting the peak current command based on voltage offset. The peak inductor current is sensed from the HS switch and compared to the peak current to control the on-time of the HS switch. The voltage feedback loop is internally compensated, which allows command for fewer external components, makes it easy to design, and provides stable operation with almost any combination of output capacitors. The regulator operates with fixed switching frequency in continuous conduction mode (CCM) and discontinuous conduction mode (DCM). At very light load, the LM76002-Q1/LM76003-Q1 operates in PFM to maintain high efficiency, and the switching frequency decreases with reduced load current.

7.3.2 Light Load Operation Modes — PFM and FPWM

DCM operation is employed in the LM76002-Q1/LM76003-Q1 when the inductor current valley reaches zero. The LM76002-Q1/LM76003-Q1 is in DCM when load current is less than half of the peak-to-peak inductor current ripple in CCM. In DCM, the LS switch is turned off when the inductor current reaches zero. Switching loss is reduced by turning off the LS FET at zero current, and the conduction loss is lowered by not allowing negative current conduction. Power conversion efficiency is higher in DCM than CCM under the same conditions.

In DCM, the HS switch on-time reduces with lower load current. When either the minimum HS switch on-time (t_{ON-MIN}) or the minimum peak inductor current ($I_{PEAK-MIN}$) is reached, the switching frequency decreases to maintain regulation. At this point, the LM76002-Q1/LM76003-Q1 operates in PFM. In PFM, switching frequency is decreased by the control loop when load current reduces to maintain output voltage regulation. Switching loss is further reduced in PFM operation due to less frequent switching actions.

Feature Description (continued)

In PFM operation, a small positive DC offset is required at the output voltage to activate the PFM detector. The lower the frequency is in PFM, the more DC offset is needed at V_{OUT} . See [Typical Characteristics](#) for typical DC offset at very light load. If the DC offset on V_{OUT} is not acceptable for a given application, TI recommends a static load at output to reduce or eliminate the offset. Lowering values of the feedback divider R_{FBT} and R_{FBB} can also serve as a static load. In conditions with low V_{IN} and/or high frequency, the LM76002-Q1/LM76003-Q1 may not enter PFM mode if the output voltage cannot be charged up to provide the trigger to activate the PFM detector. Once the LM76002-Q1/LM76003-Q1 is operating in PFM mode at higher V_{IN} , it remains in PFM operation when V_{IN} is reduced.

Alternatively, the device can run in a forced pulse-width-modulation (FPWM) mode where the switching frequency does not lower with load, and no offset is added to affect the V_{OUT} accuracy unless the minimum on-time of the converter is reached.

7.3.3 Adjustable Output Voltage

The voltage regulation loop in the LM76002-Q1/LM76003-Q1 regulates the FB voltage to be the same as the internal reference voltage. The output voltage of the LM76002-Q1/LM76003-Q1 is set by a resistor divider to program the ratio from V_{OUT} to V_{FB} . The resistor divider is connected from the output node to ground with the mid-point connecting to the FB pin.



图 11. Output Voltage Setting

The voltage reference system produces a precise $\pm 1\%$ voltage reference over temperature. TI recommends using divider resistors with 1% tolerance or better with temperature coefficient of 100 ppm or lower. Selection of R_{FBT} equal or lower than 100 k Ω is also recommended. R_{FBB} can be calculated by 式 1:

$$R_{FBB} = \frac{V_{FB}}{V_{OUT} - V_{FB}} R_{FBT} \quad (1)$$

Larger R_{FBT} and R_{FBB} values reduce the current that goes through the divider, thus helping to increase light load efficiency. However, larger values also make the feedback path more susceptible to noise. If efficiency at very light load is not critical in a certain application, TI recommends $R_{FBT} = 10 \text{ k}\Omega$ to 100 k Ω . If the resistor divider is not connected properly, output voltage cannot be regulated because the feedback loop is broken. If the FB pin is shorted to ground or disconnected, the output voltage is driven close to V_{IN} because the regulator detects very low voltage on the FB node. The load connected to V_{OUT} could be damaged in this case. It is important to route the feedback trace away from the noisy area of the PCB. For more layout recommendations, see [Layout](#).

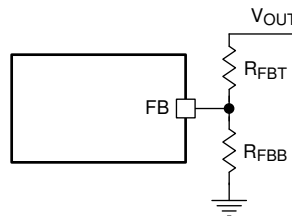
The minimum output voltage achievable equals V_{FB} , with R_{FBB} open. The maximum V_{OUT} is limited by the maximum duty cycle at a given frequency:

$$D_{MAX} = 1 - (t_{OFF_MIN} / T_{SW})$$

where

- t_{OFF_MIN} is the minimum off time of the HS switch
 - $T_{SW} = 1 / f_{SW}$ is the switching period
- (2)

Ideally, without frequency foldback, $V_{OUT_MAX} = V_{IN_MIN} \times D_{MAX}$

Maximum output voltage with frequency foldback can be estimated using 式 3:

$$V_{OUT_MAX} = V_{IN_MIN} \times \frac{t_{ON_MAX}}{t_{ON_MAX} + t_{OFF_MIN}} - I_{OUT} \times (R_{DS_ON_HS} + DCR) \quad (3)$$

Feature Description (continued)

7.3.4 Enable (EN Pin) and UVLO

System UVLO by EN and V_{CC_UVLO} voltage on the EN pin (V_{EN}) controls the ON/OFF functionality of the LM76002-Q1/LM76003-Q1. Applying a voltage less than 0.3 V to the EN input shuts down the operation of the LM76002-Q1/LM76003-Q1. In shutdown mode the quiescent current drops to typically 1.2 μ A at $V_{IN} = 24$ V.

The internal LDO output voltage V_{CC} is turned on when $V_{EN_VOUT_H}$ is higher than 1.15 V. The LM76002-Q1/LM76003-Q1 switching action and output regulation are enabled when V_{EN} is greater than 1.204 V (typical). The LM76002-Q1/LM76003-Q1 supplies regulated output voltage when enabled and output current up to 2.5 A/3.5 A. The EN pin is an input and cannot be open circuit or floating. The simplest way to enable the operation of the LM76002-Q1/LM76003-Q1 is to connect the EN pin to PVIN pins directly. This allows self-start-up of the LM76002-Q1/LM76003-Q1 when V_{IN} is within the operation range.

Many applications may benefit from the employment of an enable divider R_{ENT} and R_{ENB} (see [Figure 12](#)) to establish a precision system UVLO level for the stage. System UVLO can be used for supplies operating from utility power as well as battery power. It can be used for sequencing, ensuring reliable operation, or supply protection, such as a battery. An external logic signal can also be used to drive EN input for system sequencing and protection.

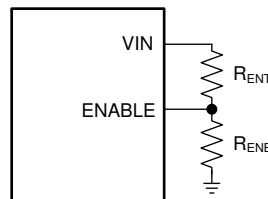

Figure 12. V_{IN} UVLO

With a selected R_{ENT} , the R_{ENB} can be calculated by:

$$R_{ENB} = \frac{V_{EN_VOUT_H} \times R_{ENT}}{V_{IN_ON_H} - V_{EN_VOUT_H}}$$

where

- $V_{IN_ON_H}$ is the desired supply voltage threshold to turn on this device
- $V_{EN_VOUT_H}$ could be taken from device data sheet

Note that the divider adds to supply quiescent current by $V_{IN} / (R_{ENT} + R_{ENB})$. Small R_{ENT} and R_{ENB} values add more quiescent current loss. However, large divider values make the node more sensitive to noise. R_{ENT} in the hundreds of k Ω range is a good starting point.

7.3.5 Internal LDO, VCC UVLO, and Bias Input

The LM76002-Q1/LM76003-Q1 has an internal LDO generating VCC voltage for control circuitry and MOSFET drivers. The nominal voltage for VCC is 3.29 V. The VCC pin must have a 1- μ F to 4.7- μ F bypass capacitor placed as close as possible to the pin and properly grounded. Do not load or short the VCC pin to ground during operation. Shorting the VCC pin to ground during operation may damage the device.

An UVLO prevents the LM76002-Q1/LM76003-Q1 from operating until the VCC voltage exceeds V_{CC_UVLO} . The V_{CC_UVLO} threshold is 3.14 V and has approximately 575 mV of hysteresis, so the device operates until V_{CC} drops below 2.575 V (typical). Hysteresis prevents the device from turning off during power up if V_{IN} droops due to input current demands.

The LDO can generate V_{CC} from two inputs: the supply voltage V_{IN} and the BIAS input. The LDO power loss is calculated by $I_{LDO} \times (V_{IN_LDO} - V_{OUT_LDO})$. The higher the difference between the input and output voltages of the LDO, the more losses occur to supply the same LDO output current. The BIAS input is designed to reduce the difference of the input and output voltages of the LDO to improve efficiency, especially at light load. TI recommends tying the BIAS pin to V_{OUT} when the output voltage is equal to or greater than 3.3 V. Tie the BIAS pin to ground for applications less than 3.3 V. BIAS can also tie to external voltage source if available to improve efficiency. When used, TI recommends a 1- μ F to 10- μ F high-quality ceramic capacitor be used to bypass the BIAS pin to ground. If there is high-frequency noise or voltage spikes present on V_{OUT} (during transient events or fault conditions), TI recommends connecting a resistor (1 to 10 Ω) between V_{OUT} and BIAS.

Feature Description (continued)

The V_{CC} voltage is typically 3.27 V. When the LM76002-Q1/LM76003-Q1 is operating in PFM mode with frequency foldback, V_{CC} voltage is reduced to 3.1 V (typical) to further decrease the quiescent current and improve efficiency at very light loads. [Figure 13](#) shows an example of V_{CC} voltage change with mode change.

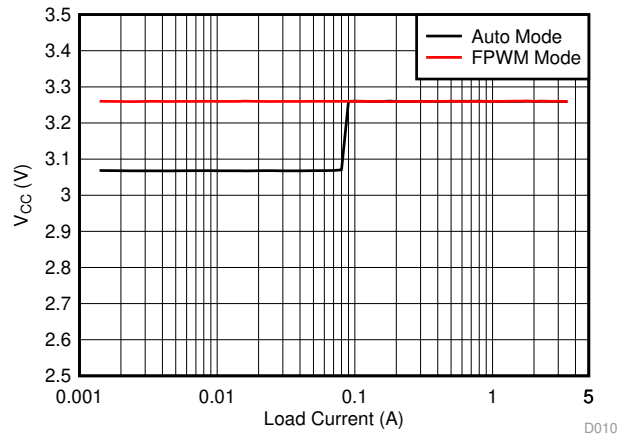

Figure 13. V_{CC} Voltage Change With Mode Change

V_{CC} voltage has an internal undervoltage lockout threshold, V_{CC_UVLO} . When V_{CC} voltage is higher than V_{CC_UVLO} rising threshold, the device is active and in normal operation if $V_{EN} > V_{EN_VOUT_H}$. If V_{CC} voltage droops below V_{CC_UVLO} falling threshold, the V_{OUT} is shut down.

7.3.6 Soft Start and Voltage Tracking (SS/TRK)

The LM76002-Q1/LM76003-Q1 has a flexible and easy-to-use start-up rate control pin: SS/TRK. The soft-start feature is to prevent inrush current impacting the LM76002-Q1/LM76003-Q1, and its supply when power is first applied. Soft start is achieved by slowly ramping up the target regulation voltage when the device is first enabled or powered up. The simplest way to use the device is to leave the SS/TRK pin open circuit or floating. The LM76002-Q1/LM76003-Q1 employs the internal soft-start control ramp and starts up to the regulated output voltage in 6.3 ms typically. In applications with a large amount of output capacitors, higher V_{OUT} , or other special requirements, the soft-start time can be extended by connecting an external capacitor C_{SS} from SS/TRK pin to AGND. Extended soft-start time further reduces the supply current required to charge up output capacitors and supply any output loading. An internal current source ($I_{SSC} = 2.2 \mu\text{A}$) charges C_{SS} and generates a ramp from 0 V to VFB to control the ramp-up rate of the output voltage. For a desired soft-start time t_{SS} , the capacitance for C_{SS} can be found by [Equation 5](#):

Feature Description (continued)

$$C_{SS} = I_{SSC} \times t_{SS}$$

where

- C_{SS} = soft-start capacitor value (μF)
 - I_{SSC} = soft-start charging current (μA)
 - t_{SS} = desired soft-start time (s)
- (5)

The soft-start capacitor C_{SS} is discharged by an internal FET when V_{OUT} is shut down by hiccup protection or $\text{ENABLE} = \text{logic low}$. When a large C_{SS} is applied, and EN is toggled low only for a short period of time, C_{SS} may not be fully discharged. The next soft-start ramp follows internal soft-start ramp before reaching the leftover voltage on C_{SS} and then follows the ramp programmed by C_{SS} . If this is not acceptable for a certain application, an R-C low-pass filter can be added to EN to slow down the shutting down of V_{CC} , allowing more time to discharge C_{SS} .

The LM76002-Q1/LM76003-Q1 is capable of start-up into pre-biased output conditions. When the inductor current reaches zero, the LS switch is turned off to avoid negative current conduction. This operation mode is also called diode emulation mode. It is built in by the DCM operation in light loads. With a pre-biased output voltage, the LM76002-Q1/LM76003-Q1 waits until the soft-start ramp allows regulation above the pre-biased voltage and then follows the soft-start ramp to the regulation level. When an external voltage ramp is applied to the SS/TRK pin, the LM76002-Q1/LM76003-Q1 FB voltage follows the ramp if the ramp magnitude is lower than the internal soft-start ramp. A resistor divider pair can be used on the external control ramp to the SS/TRK pin to program the tracking rate of the output voltage. The final voltage detected by the SS/TRK pin must not fall below 1.2 V to avoid abnormal operation

V_{OUT} tracked to an external voltage ramp has the option of ramping up slower or faster than the internal voltage ramp. V_{FB} always follows the lower potential of the internal voltage ramp and the voltage on the SS/TRK pin. [Figure 14](#) shows resistive divider connection if external ramp tracking is desired.

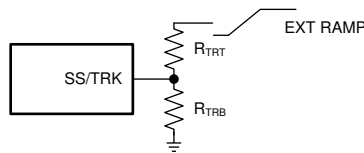

Figure 14. Soft-Start Tracking External Ramp

[Figure 15](#) shows the case when V_{OUT} ramps more slowly than the internal ramp, while [Figure 16](#) shows when V_{OUT} ramps faster than the internal ramp. Faster start-up time may result in inductor current tripping current protection during start-up. Use with special care.

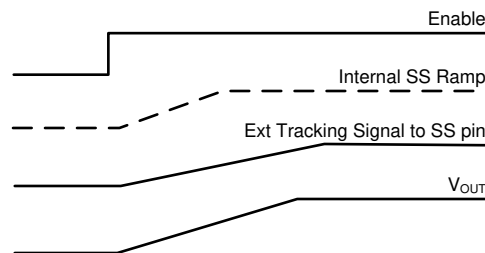

Figure 15. Tracking With Longer Start-up Time Than The Internal Ramp

Feature Description (continued)



图 16. Tracking With Shorter Start-up Time Than The Internal Ramp

The LM76002-Q1/LM76003-Q1 is capable of start-up into pre-biased output conditions. During start-up the device sets the minimum inductor current to zero to avoid discharging a pre-biased load.

7.3.7 Adjustable Switching Frequency (RT) and Frequency Synchronization

The switching frequency of the LM76002-Q1/LM76003-Q1 can be programmed by the impedance R_T from the RT pin to ground. The frequency is inversely proportional to the R_T resistance. The RT pin can be left floating, and the LM76002-Q1/LM76003-Q1 operates at 500-kHz default switching frequency. The RT pin is not designed to be shorted to ground.

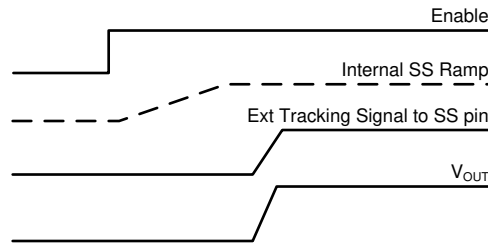
For an desired frequency, R_T can be found by:

$$R_T(k\Omega) = \frac{38400}{\text{Frequency}(kHz) - 14.33} \tag{6}$$



图 17. Switching Frequency vs RT

表 1. Switching Frequency vs RT

SWITCHING FREQUENCY (kHz)	RT RESISTANCE (kΩ)
300	134.42
400	99.57
500	79.07
750	52.20
1000	38.96
1500	25.85
2000	19.34
2200	17.57

The LM76002-Q1/LM76003-Q1 switching action can also be synchronized to an external clock from 300 kHz to 2.2 MHz. TI recommends connecting an external clock to the SYNC pin with appropriate termination resistor. Ground the SYNC pin if not used.

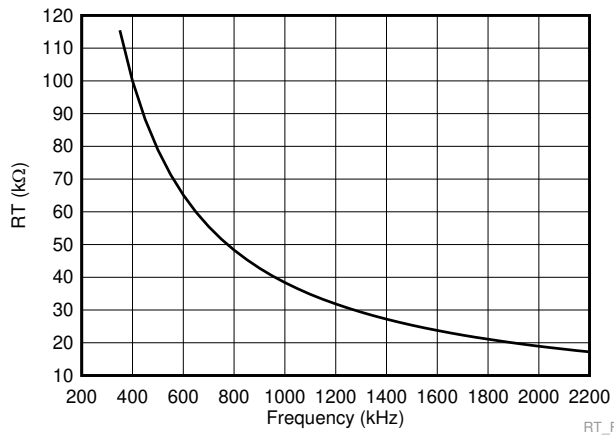
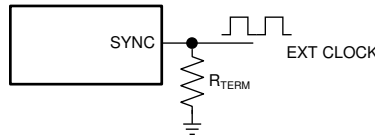

✎ **18. Frequency Synchronization**

The recommendations for the external clock include high level no lower than 2 V, low level no higher than 0.4 V, duty cycle between 10% and 90%, and both positive and negative pulse width no shorter than 80 ns. When the external clock fails at logic high or low, the LM76002-Q1/LM76003-Q1 switches at the frequency programmed by the R_T resistor after a time-out period. TI recommends connecting a resistor R_T to the RT pin so that the internal oscillator frequency is the same as the target clock frequency when the LM76002-Q1/LM76003-Q1 is synchronized to an external clock. This allows the regulator to continue operating at approximately the same switching frequency if the external clock fails.

The choice of switching frequency is usually a compromise between conversion efficiency and the size of the circuit. Lower switching frequency implies reduced switching losses (including gate charge losses, switch transition losses, etc.) and usually results in higher overall efficiency. However, higher switching frequency allows use of smaller LC output filters and hence a more compact design. Lower inductance also helps transient response (higher large signal slew rate of inductor current), and reduces the DCR loss. The optimal switching frequency is usually a trade-off in a given application and thus needs to be determined on a case-by-case basis. It is related to the input voltage, output voltage, most frequent load current level(s), external component choices, and circuit size requirement. The choice of switching frequency may also be limited if an operating condition triggers t_{ON-MIN} or $t_{OFF-MIN}$.

7.3.8 Minimum On-Time, Minimum Off-Time, and Frequency Foldback at Dropout Conditions

Minimum on-time, t_{ON-MIN} , is the smallest duration of time that the HS switch can be on. t_{ON-MIN} is typically 65 ns in the LM76002-Q1/LM76003-Q1. Minimum off-time, $t_{OFF-MIN}$, is the smallest duration that the HS switch can be off. $t_{OFF-MIN}$ is typically 95 ns in the LM76002-Q1/LM76003-Q1. In CCM operation, t_{ON-MIN} and $t_{OFF-MIN}$ limits the voltage conversion range given a selected switching frequency. The minimum duty cycle allowed is:

$$D_{MIN} = t_{ON-MIN} \times f_{SW} \quad (7)$$

And the maximum duty cycle allowed is:

$$D_{MAX} = 1 - t_{OFF-MIN} \times f_{SW} \quad (8)$$

Given fixed t_{ON-MIN} and $t_{OFF-MIN}$, the higher the switching frequency the narrower the range of the allowed duty cycle. In the LM76002-Q1/LM76003-Q1, frequency foldback scheme is employed to extend the maximum duty cycle when $t_{OFF-MIN}$ is reached. The switching frequency decreases once longer duty cycle is needed under low V_{IN} conditions. The switching frequency can be decreased to approximately 1/10 of the programmed frequency by RT or the synchronization clock. Such a wide range of frequency foldback allows the LM76002-Q1/LM76003-Q1 output voltage to stay in regulation with a much lower supply voltage V_{IN} . This leads to a lower effective dropout voltage. See [Typical Characteristics](#) for more details.

Given an output voltage, the choice of the switching frequency affects the allowed input voltage range, solution size and efficiency. The maximum operational supply voltage can be found by:

$$V_{IN-MAX} = V_{OUT} / (f_{SW} \times t_{ON-MIN}) \quad (9)$$

At lower supply voltage, the switching frequency decreases once $t_{OFF-MIN}$ is tripped. The minimum V_{IN} without frequency foldback can be approximated by:

$$V_{IN-MIN} = V_{OUT} / (f_{SW} \times t_{OFF-MIN}) \quad (10)$$

Considering power losses in the system with heavy load operation, V_{IN-MIN} is higher than the result calculated in [式 10](#). With frequency foldback, V_{IN-MIN} is lowered by decreased f_{SW} . When the device is operating in auto mode at voltages near maximum rated input voltage and light load conditions, an increased output voltage ripple during load transient may be observed. For this reason TI recommends that device operating point be calculated with sufficient operational margin so that minimum on-time condition is not triggered.

7.3.9 Internal Compensation and C_{FF}

The LM76002-Q1/LM76003-Q1 is internally compensated with R_C = 600 kΩ and C_C = 35 pF as shown in the [Functional Block Diagram](#). The internal compensation is designed such that the loop response is stable over the entire operating frequency and output voltage range. Depending on the output voltage, the compensation loop phase margin can be low with all ceramic capacitors. TI recommends placing an external feed-forward cap C_{FF} in parallel with the top resistor divider R_{F_{BT}} for optimum transient performance.

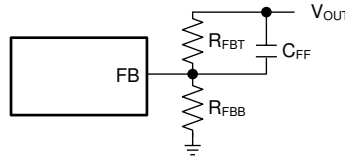

✎ 19. Feed-Forward Capacitor for Loop Compensation

The feed-forward capacitor C_{FF} in parallel with R_{F_{BT}} places an additional zero before the crossover frequency of the control loop to boost phase margin. The zero frequency can be found by [Equation 11](#):

$$f_{Z-CFF} = 1 / (2\pi \times R_{F_{BT}} \times C_{FF}) \quad (11)$$

An additional pole is also introduced with C_{FF} at the frequency of [Equation 12](#):

$$f_{P-CFF} = 1 / (2\pi \times C_{FF} \times (R_{F_{BT}} // R_{F_{BB}})) \quad (12)$$

Select the C_{FF} so that the bandwidth of the control loop without the C_{FF} is centered between f_{Z-CFF} and f_{P-CFF}. The zero f_{Z-CFF} adds phase boost at the crossover frequency and improves transient response. The pole f_{P-CFF} helps maintaining proper gain margin at frequency beyond the crossover.

Electrolytic capacitors have much larger ESR and the ESR zero frequency would be low enough to boost the phase up around the crossover frequency.

$$f_{Z-ESR} = 1 / (2\pi \times ESR \times C_{OUT}) \quad (13)$$

Designs using mostly electrolytic capacitors at the output may not need any C_{FF}. The C_{FF} creates a time constant with R_{F_{BT}} that couples in the attenuated output voltage ripple to the FB node. If the C_{FF} value is too large, it can couple too much ripple to the FB and affect V_{OUT} regulation. It could also couple too much transient voltage deviation and falsely trip PGOOD thresholds. Therefore, calculate C_{FF} based on output capacitors used in the system. At cold temperatures, the value of C_{FF} might change based on the tolerance of the chosen component. This may reduce its impedance and ease noise coupling on the FB node. To avoid this, more capacitance can be added to the output or the value of C_{FF} can be reduced. See [Feed-Forward Capacitor](#) for the calculation of C_{FF}.

7.3.10 Bootstrap Voltage and VBOOT UVLO (BOOT Pin)

The driver of the power switch (HS switch) requires bias higher than V_{IN} when the HS switch is ON. The capacitor connected between C_{BOOT} and SW works as a charge pump to boost voltage on the BOOT pin to (V_{SW} + V_{CC}). The boot diode is integrated on the LM76002-Q1/LM76003-Q1 die to minimize physical size. TI recommends a 0.47-μF, 6.3-V or higher capacitor for C_{BOOT}. The V_{BOOT_UVLO} threshold is typically 2.2 V. If the C_{BOOT} capacitor is not charged above this voltage with respect to SW, the device initiates a charging sequence using the low-side FET.

7.3.11 Power Good and Overvoltage Protection (PGOOD)

The LM76002-Q1/LM76003-Q1 has a built-in power-good flag shown on PGOOD pin to indicate whether the output voltage is within its regulation level. The PGOOD signal can be used for start-up sequencing of multiple rails. The PGOOD pin is an open-drain output that requires a pullup resistor to an appropriate logic voltage (any voltage below 12 V). The pin can sink 5 mA of current and maintain its specified logic low level. A typical range of pullup resistor value is 10 kΩ to 100 kΩ. When the FB voltage is outside the power-good band, +10% above and –10% below the internal reference V_{REF} typically, the PGOOD switch is turned on, and the PGOOD pin voltage is pulled to ground. When the FB is 2% (typical) closer to FB than the PGOOD threshold, the PGOOD switch is turned off, and the pin is pulled up to the voltage connected to the pullup resistor. Both rising and falling edges of the power-good flag have a built-in 220-μs (typical) deglitch delay. To pull up PGOOD pin to a voltage higher than 15V, a resistor divider can be used to divide the voltage down.



图 20. PGOOD Resistor Divider

For given pullup voltage V_{PU} and desired voltage on PGOOD pin is V_{PG} and with R_{PGT} chosen, value for R_{PGB} can be calculated using 式 14:

$$R_{PGB} = \frac{V_{PG}}{V_{PU} - V_{PG}} R_{PGT} \quad (14)$$

7.3.12 Overcurrent and Short-Circuit Protection

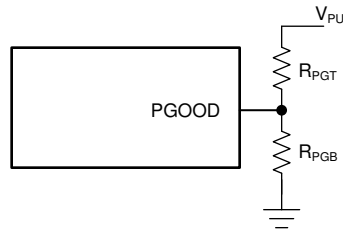
The LM76002-Q1/LM76003-Q1 is protected from overcurrent conditions by cycle-by-cycle current limiting on both peak and valley of the inductor current. Hiccup mode is activated if a fault condition persists to prevent overheating.

High-side MOSFET overcurrent protection is implemented by the nature of the peak current-mode control. The HS switch current is sensed when the HS is turned on after a blanking time. The HS switch current is compared to the either the minimum of a fixed current set point (I_{SC}) or the output of the voltage regulation loop minus slope compensation every switching cycle. The slope compensation increases with duty cycle and tends to lower the HS current limit above 60% duty cycle as it lowers below I_{SC} . See *Typical Characteristics*.

When the LS switch is turned on, the current going through it is also sensed and monitored. Before turning off the LS switch at the end of every clock cycle, the LS current is compared to the LS current limit. If the LS current limit is exceeded, the LS MOSFET stays on, and the HS switch is not turned on. The LS switch is kept ON so that inductor current keeps ramping down, until the inductor current ramps below $I_{LSLIMIT}$. The LS switch is turned off once the LS current falls below the limit, and the HS switch is turned on again after a dead time.

If the current of the LS switch is higher than the LS current limit for 128 consecutive cycles, and the feedback voltage falls 60% below regulation, hiccup current-protection mode is activated. In hiccup mode, the regulator is shut down and kept off for 46 ms typically before the LM76002-Q1/LM76003-Q1 tries to start again. If overcurrent or a short-circuit fault condition still exists, hiccup repeats until the fault condition is removed. Hiccup mode reduces power dissipation under severe overcurrent conditions, and prevents overheating and potential damage to the device. Under non-severe overcurrent conditions when the feedback voltage has not fallen 60% below regulation, the LM76002-Q1/LM76003-Q1 reduces the switching frequency and keeps the inductor current valley clamped at the LS current limit level. This operation mode allows slight overcurrent operation during load transients without tripping hiccup.

If tracking was used for initial sequencing the device attempts to restart using the internal soft-start circuit until the tracking voltage is reached.

7.3.13 Thermal Shutdown

Thermal shutdown limits total power dissipation by turning off the internal switches when the device junction temperature exceeds 160°C (typical). After thermal shutdown occurs, hysteresis prevents the device from switching until the junction temperature drops to approximately 135°C. When the junction temperature falls below 135°C, the LM76002-Q1/LM76003-Q1 attempts to soft start.

7.4 Device Functional Modes

7.4.1 Shutdown Mode

The EN pin provides electrical on/off control for the LM76002-Q1/LM76003-Q1. When the EN pin voltage is below 0.3 V (typical), both the regulator and the internal LDO have no output voltages, and the device is in shutdown mode. In shutdown mode the quiescent current drops to typically 1.2 μ A. The LM76002-Q1/LM76003-Q1 also employs UVLO protection. If V_{CC} voltage is below the UVLO level, the output of the regulator is turned off.

7.4.2 Standby Mode

The internal LDO has a lower EN threshold than the regulator. When the EN pin voltage is above below 1.1 V (maximum) and below the precision enable threshold for the output voltage, the internal LDO regulates the V_{CC} voltage at 3.29 V typically. The precision enable circuitry is ON once V_{CC} is above the UVLO. The internal MOSFETs remain in tri-state unless the voltage on EN pin goes above the precision enable threshold. The LM76002-Q1/LM76003-Q1 also employs UVLO protection. If V_{CC} voltage is below the UVLO level, the output of the regulator is turned off.

7.4.3 Active Mode

The LM76002-Q1/LM76003-Q1 is in active mode when the EN pin and UVLO high threshold levels are satisfied. The simplest way to enable the operation of the LM76002-Q1/LM76003-Q1 is to connect the EN pin to VIN, which allows self start-up of the LM76002-Q1/LM76003-Q1 when the input voltage is in the operation range: 3.5 V to 60 V. See [Enable \(EN Pin\) and UVLO](#) for details on setting these operating levels.

In active mode, depending on the load current, the LM76002-Q1/LM76003-Q1 will be in one of five sub modes:

1. CCM with fixed switching frequency with load between half of I_{MINPK} to full load.
2. DCM when the load current is lower than half of the inductor current ripple.
3. Light load mode where the device uses pulse frequency modulation (PFM) and lowers the switching frequency at load under half of I_{MINPK} to improve efficiency.
4. Foldback mode when switching frequency is reduced to maintain output regulation with supply voltages that cause the minimum t_{ON} or t_{OFF} to be exceeded.
5. Forced-pulse-width modulation (FPWM) is similar to CCM with fixed switching frequency, but extends the fixed frequency range of operation from full to no load.

7.4.4 CCM Mode

CCM operation is employed in the LM76002-Q1/LM76003-Q1 when the load current is higher than $\frac{1}{2}$ of the peak-to-peak inductor current. If the load current is decreased, the device enters DCM mode. In CCM operation, the frequency of operation is constant and fixed unless the minimum t_{ON} or t_{OFF} are exceeded which causes the part to enter fold back mode (refer to [Internal LDO, VCC UVLO, and Bias Input](#) for details). In these cases, PWM is still maintained, but the frequency of operation is folded back (reduced) to maintain proper regulation.

7.4.5 DCM Mode

DCM operation is employed in the LM76002-Q1/LM76003-Q1 when the load current is lower than $\frac{1}{2}$ of the peak-to-peak inductor current. In DCM operation (also known as diode emulation mode), the LS FET is turned off when the inductor current drops below 0 A to keep operation as efficient as possible by reducing switching losses and preventing negative current conduction. In PWM operation, the frequency of operation is constant and fixed unless the load current is reduced below I_{PEAK_MIN} , which causes the part to enter light load mode, or if the minimum t_{ON} or t_{OFF} are exceeded, which cause the device to enter foldback mode.

7.4.6 Light Load Mode

At light output current loads, PFM is activated for the highest efficiency possible. When the inductor current does not reach I_{PEAK_MIN} during a switching cycle, the on-time is increased, and the switching frequency reduces as needed to maintain proper regulation. The on-time has a maximum value of 8 μ s to avoid large output voltage ripple in dropout conditions. Efficiency is greatly improved by reducing switching and gate-drive losses. During light-load mode of operation the LM76002-Q1/LM76003-Q1 operates with a minimum quiescent current of 10 to 15 μ A (typical).

Device Functional Modes (continued)

7.4.7 Foldback Mode

Foldback protection modes are entered when the duty cycle exceeds the minimum on- and off-times of the device. At very high duty cycles, where the minimum off-time is not satisfied, the frequency folds back to allow more time for the peak current command to be reached. The maximum on-time is 8 μs , which limits the maximum duty cycle in dropout to 98%. At very low duty cycles when the minimum on-time is reached, the device maintains regulation by dropping the frequency to allow more time for the inductor current to discharge the output capacitor. Foldback mode is exited once the minimum on-time and off-times are satisfied.

7.4.8 Forced Pulse-Width-Modulation Mode

FPWM is employed when the FPWM pin is pulled high, or the device is synchronized to an external clock. In this mode, diode emulation is turned off, and the device remains in CCM over the full load range. In FPWM operation, the frequency of operation is constant and fixed unless the minimum t_{ON} or t_{OFF} are exceeded, which cause the device to enter foldback mode. In these cases, PWM operation is still maintained, but the frequency of operation is folded back (reduced) to maintain proper regulation. DC accuracy is at a minimum in FPWM mode.

7.4.9 Self-Bias Mode

For highest efficiency of operation, TI recommends that the BIAS pin be connected directly to V_{OUT} when $3.3\text{ V} \leq V_{\text{OUT}} \leq 24\text{ V}$. In this self-bias mode of operation, the difference between the input and output voltages of the internal LDO are reduced, and therefore the total efficiency of the LM76002-Q1/LM76003-Q1 is improved. These efficiency gains are more evident during light load operation. During this mode of operation, the LM76002-Q1/LM76003-Q1 operates with a minimum quiescent current of 15 μA (typical). See [Internal LDO](#), [VCC UVLO](#), and [Bias Input](#) for more details.

8 Application and Implementation

注

Information in the following applications sections is not part of the TI component specification, and TI does not warrant its accuracy or completeness. TI's customers are responsible for determining suitability of components for their purposes. Customers should validate and test their design implementation to confirm system functionality.

8.1 Application Information

The LM76002-Q1/LM76003-Q1 is a step-down DC-DC converter. It is typically used to convert a higher DC voltage to a lower DC voltage with a maximum output current of 3.5 A. The following design procedure can be used to select component values for the LM76002-Q1/LM76003-Q1. Alternately, the WEBENCH® software may be used to generate a complete design. The WEBENCH software uses an iterative design procedure and accesses a comprehensive database of components when generating a design (see).

8.2 Typical Applications

The LM76002-Q1/LM76003-Q1 only requires a few external components to convert from a wide range of supply voltage to output voltage, as shown in [Figure 21](#):

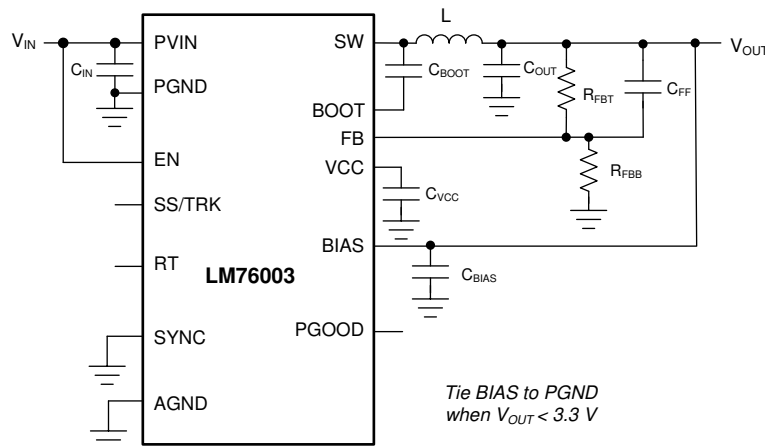

Figure 21. LM76002-Q1/LM76003-Q1 Basic Schematic

The LM76002-Q1/LM76003-Q1 also integrates a full list of features to aid system design requirements, such as VCC UVLO, programmable soft start, start-up tracking, programmable switching frequency, clock synchronization, and a power-good indication. Each system can select the features needed in a specific application. A comprehensive schematic with all features utilized is shown in [Figure 22](#):

Typical Applications (continued)



图 22. LM76002-Q1/LM76003-Q1 Comprehensive Schematic

The external components must fulfill the requirements of the application, but also the stability criteria of the device control loop. The LM76002-Q1/LM76003-Q1 is optimized to work within a range of external components. Inductance and capacitance of the LC output filter each create poles that have to be considered in the control of the converter. 表 2 can be used to simplify the output filter component selection.

表 2. Typical Component Selection

f_{sw} (kHz)	V_{OUT} (V)	L (μ H)	C_{OUT} (μ F)	R_{FBT} (k Ω)	R_{FBB} (k Ω)
300	1	2.5	680	100	OPEN
500	1	1.5	470	100	OPEN
1000	1	0.68	200	100	OPEN
2200	1	0.47	120	100	OPEN
300	3.3	6.8	200	100	43.5
500	3.3	4.7	150	100	43.5
1000	3.3	2.5	88	100	43.5
2200	3.3	1.2	44	100	43.5
300	5	10	150	100	25
500	5	6.8	100	100	25
1000	5	3.3	66	100	25
2200	5	1.5	44	100	25
300	12	22	66	100	9.09
500	12	15	44	100	9.09
1000	12	6.8	22	100	9.09
2200	12	3.3	22	100	9.09
300	24	47	40	100	4.37
500	24	27	33	100	4.37
1000	24	15	22	100	4.37
2200	24	6.8	22	100	4.37

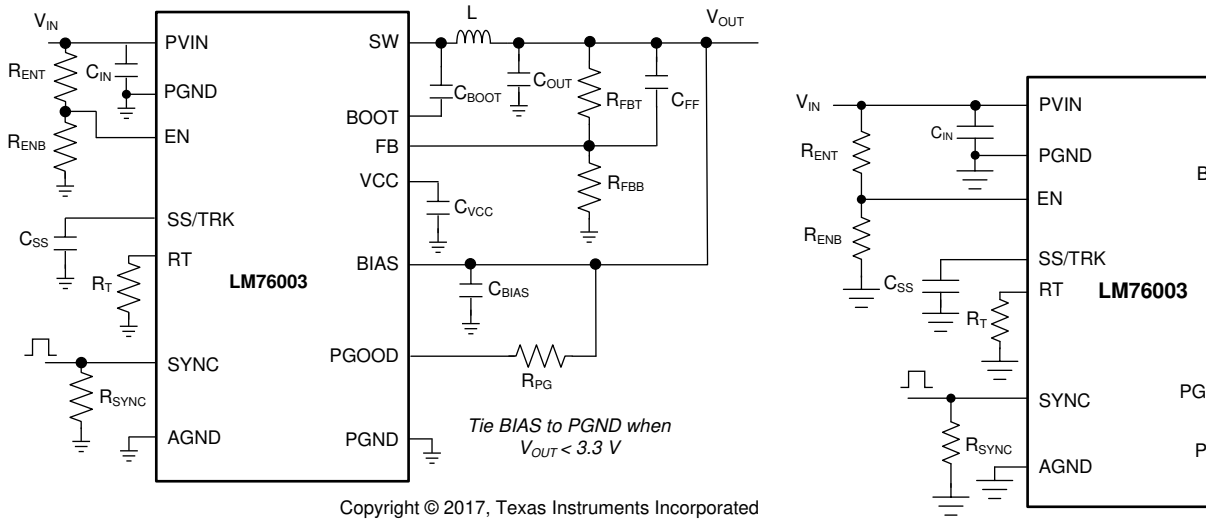
8.2.1 Design Requirements

Detailed Design Procedure is based on a design example. For this design example, use the parameters listed in [表 3](#) as the input parameters.

表 3. Design Example Parameters

DESIGN PARAMETER	VALUE
Input voltage range	3.5 V to 60 V
Output voltage	3.3 V
Input ripple voltage	400 mV
Output ripple voltage	30 mV
Output current rating	3.5 A
Operating frequency	500 kHz

8.2.2 Detailed Design Procedure

8.2.2.1 Custom Design With WEBENCH® Tools

[Click here](#) to create a custom design using the LM76002-Q1/LM76003-Q1 device with the WEBENCH® Power Designer.

1. Start by entering the input voltage (V_{IN}), output voltage (V_{OUT}), and output current (I_{OUT}) requirements.
2. Optimize the design for key parameters such as efficiency, footprint, and cost using the optimizer dial.
3. Compare the generated design with other possible solutions from Texas Instruments.

The WEBENCH Power Designer provides a customized schematic along with a list of materials with real-time pricing and component availability.

In most cases, these actions are available:

- Run electrical simulations to see important waveforms and circuit performance
- Run thermal simulations to understand board thermal performance
- Export customized schematic and layout into popular CAD formats
- Print PDF reports for the design, and share the design with colleagues

Get more information about WEBENCH tools at www.ti.com/WBENCH.

8.2.2.2 Output Voltage Setpoint

The output voltage of the LM76002-Q1/LM76003-Q1 device is externally adjustable using a resistor divider network. In the application circuit of [图 22](#), this divider network is comprised of top feedback resistor R_{FBT} and bottom feedback resistor R_{FBB} . [式 15](#) is used to determine the output voltage of the converter:

$$R_{FBB} = \frac{V_{FB}}{V_{OUT} - V_{FB}} R_{FBT} \quad (15)$$

Choose the value of the R_{FBT} to be around 1 M Ω to minimize quiescent current during light load operation or 100k Ω to improve noise immunity. With the desired output voltage set to be 3.3 V and with a $V_{FB} = 1$ V, the R_{FBB} value can then be calculated using [式 15](#). The formula yields a value of 434.78 k Ω . Choose the closest available value of 432 k Ω for the R_{FBB} , or a combination of two resistors (432 k Ω + 2.74 k Ω) to increase initial accuracy.

8.2.2.3 Switching Frequency

The default switching frequency of the LM76002-Q1/LM76003-Q1 device is set at 500 kHz. If the R_T is left open, the LM76002-Q1/LM76003-Q1 switches at 500 kHz in CCM mode. Use [式 16](#) to calculate the required value for R_T in order to operate the LM76002-Q1/LM76003-Q1 at different frequencies.

$$R_T(k\Omega) = \frac{38400}{\text{Frequency}(kHz) - 14.33} \quad (16)$$

The unit for the result is k Ω .

8.2.2.4 Input Capacitors

The LM76002-Q1/LM76003-Q1 device requires an input decoupling and, depending on the application, a bulk input capacitor. The typical recommended value for the high frequency decoupling capacitor is 10 μF to 22 μF . TI recommends a high-quality ceramic type X5R or X7R with sufficiency voltage rating. The voltage rating must be greater than the maximum input voltage. To compensate the derating of ceramic capacitors, a voltage rating of twice the maximum input voltage is recommended. Additionally, some bulk capacitance can be required, especially if the LM76002-Q1/LM76003-Q1 circuit is not located within approximately 5 cm from the input voltage source. This capacitor is used to provide damping to the voltage spiking due to the lead inductance of the cable. The optimum value for this capacitor is four times the ceramic input capacitance with ESR close to the characteristic impedance of the LC filter formed by the application input inductance and ceramic input capacitors.

For this design, two 4.7- μF , X7R dielectric capacitors rated for 100 V are used for the input decoupling capacitance. A single capacitor has equivalent series resistance (ESR) of approximately 3 m Ω , and an RMS current rating of 3 A. Include a capacitor with a value of 47 nF for high-frequency filtering and place it as close as possible to the device pins.

注

DC-Bias Effect: High capacitance ceramic capacitors have a DC-bias derating effect, which has a strong influence on the final effective capacitance. Therefore, choose the right capacitor value carefully. Package size and voltage rating in combination with dielectric material are responsible for differences between the rated capacitor value and the effective capacitance.

8.2.2.5 Inductor Selection

The first criterion for selecting an output inductor is the inductance itself. In most buck converters, this value is based on the desired peak-to-peak ripple current, Δi_L that flows in the inductor along with the load current. As with switching frequency, the selection of the inductor is a tradeoff between size and cost. Higher inductance means lower ripple current and hence lower output voltage ripple. Lower inductance results in smaller, less expensive devices. An inductance that gives a ripple current of 20% to 40% of the maximum output current is a good starting point. ($\Delta i_L = (1/5 \text{ to } 2/5) \times I_{\text{OUT}}$). The peak-to-peak inductor current ripple can be found by 式 17 and the range of inductance can be found by 式 18 with the typical input voltage used as V_{IN} .

$$\Delta i_L = \frac{(V_{\text{IN}} - V_{\text{OUT}}) \times D}{L \times f_{\text{SW}}} \quad (17)$$

$$\frac{(V_{\text{IN}} - V_{\text{OUT}}) \times D}{0.4 \times f_{\text{SW}} \times I_{\text{L-MAX}}} \leq L \leq \frac{(V_{\text{IN}} - V_{\text{OUT}}) \times D}{0.2 \times f_{\text{SW}} \times I_{\text{L-MAX}}} \quad (18)$$

D is the duty cycle of the converter which in a buck converter it can be approximated as $D = V_{\text{OUT}} / V_{\text{IN}}$, assuming no loss power conversion. By calculating in terms of amperes, volts, and megahertz, the inductance value comes out in micro henries. The inductor ripple current ratio is defined by:

$$r = \frac{\Delta i_L}{I_{\text{OUT}}} \quad (19)$$

The second criterion is the inductor saturation-current rating. The inductor must be rated to handle the maximum load current plus the ripple current:

$$I_{\text{L-PEAK}} = I_{\text{LOAD-MAX}} + \Delta i_L / 2 \quad (20)$$

The LM76002-Q1/LM76003-Q1 has both valley current limit and peak current limit. During an instantaneous short, the peak inductor current can be high due to a momentary increase in duty cycle. The inductor current rating should be higher than the HS current limit. TI recommends selection of an inductor with a larger core saturation margin and preferably a softer roll off of the inductance value over load current.

In general, it is preferable to choose lower inductance in switching power supplies, because it usually corresponds to faster transient response, smaller DCR, and reduced size for more compact designs. However, too low of an inductance can generate too large of an inductor current ripple such that overcurrent protection at the full load could be falsely triggered. It also generates more conduction loss because the RMS current is slightly higher relative that with lower current ripple at the same DC current. Larger inductor current ripple also implies larger output voltage ripple with the same output capacitors. With peak-current-mode control, it is not recommended to have an inductor current ripple that is too small. Enough inductor current ripple improves signal-to-noise ratio on the current comparator and makes the control loop more immune to noise.

Once the inductance is determined, the type of inductor must be selected. Ferrite designs have very low core losses and are preferred at high switching frequencies, so design goals can concentrate on copper loss and preventing saturation. Ferrite core material saturates hard, which means that inductance collapses abruptly when the peak design current is exceeded. The hard saturation results in an abrupt increase in inductor ripple current and consequent output voltage ripple. Do not allow the core to saturate.

For the design example, a standard 10- μ H inductor from Würth, Coiltronics, or Vishay can be used for the 3.3-V output with plenty of current rating margin.

8.2.2.6 Output Capacitor Selection

The device is designed to be used with a wide variety of LC filters. TI generally recommends using as little output capacitance as possible to keep cost and size down. Choose the output capacitor(s), C_{OUT} , with care as it directly affects the steady-state output-voltage ripple, loop stability, and the voltage over/undershoot during load current transients.

The output voltage ripple is essentially composed of two parts. One is caused by the inductor current ripple going through the equivalent series resistance (ESR) of the output capacitors:

$$\Delta V_{OUT-ESR} = \Delta i_L \times ESR \quad (21)$$

The other is caused by the inductor current ripple charging and discharging the output capacitors:

$$\Delta V_{OUT-C} = \Delta i_L / (8 \times f_{SW} \times C_{OUT}) \quad (22)$$

The two components in the voltage ripple are not in phase, so the actual peak-to-peak ripple is smaller than the sum of the two peaks.

Output capacitance is usually limited by transient performance specifications if the system requires tight voltage regulation in the presence of large current steps and fast slew rates. When a fast large load transient happens, output capacitors provide the required charge before the inductor current can slew to the appropriate level. The initial output voltage step is equal to the load current step multiplied by the ESR. V_{OUT} continues to droop until the control loop response increases or decreases the inductor current to supply the load. To maintain a small overshoot or undershoot during a transient, small ESR, and large capacitance are desired. But these also come with higher cost and size. Thus, the motivation is to seek a fast control loop response to reduce the output voltage deviation.

For a given input and output requirement, 式 23 gives an approximation for an absolute minimum output cap required:

$$C_{OUT} > \frac{1}{(f_{SW} \times r \times \Delta V_{OUT} / I_{OUT})} \times \left[\left(\frac{r^2}{12} \times (1+D') \right) + (D' \times (1+r)) \right] \quad (23)$$

Along with this for the same requirement, calculate the maximum ESR as per 式 24

$$ESR < \frac{D'}{f_{SW} \times C_{OUT}} \times \left(\frac{1}{r} + 0.5 \right)$$

where

- r = Ripple ratio of the inductor ripple current ($\Delta i_L / I_{OUT}$)
- ΔV_O = target output voltage undershoot
- $D' = 1 - \text{duty cycle}$
- f_{SW} = switching frequency
- I_{OUT} = load current

(24)

A general guideline for C_{OUT} range is that C_{OUT} should be larger than the minimum required output capacitance calculated by 式 23, and smaller than 10 times the minimum required output capacitance or 1 mF. In applications with V_{OUT} less than 3.3 V, it is critical that low ESR output capacitors are selected. This limits potential output voltage overshoots as the input voltage falls below the device normal operating range. To optimize the transient behavior a feed-forward capacitor could be added in parallel with the upper feedback resistor. For this design example, three 47- μ F, 10-V, X7R ceramic capacitors are used in parallel.

8.2.2.7 Feed-Forward Capacitor

The LM76002-Q1/LM76003-Q1 is internally compensated and the internal R-C values are 400 k Ω and 50 pF, respectively. Depending on the V_{OUT} and frequency F_S , if the output capacitor C_{OUT} is dominated by low ESR (ceramic types) capacitors, it could result in low phase margin. To improve the phase boost an external feed-forward capacitor C_{FF} can be added in parallel with R_{FBT} . C_{FF} is chosen such that phase margin is boosted at the crossover frequency without C_{FF} . A simple estimation for the crossover frequency without C_{FF} (f_x) is shown in 式 25, assuming C_{OUT} has very small ESR.

$$f_x = \frac{15.46}{V_{OUT} \times C_{OUT}} \quad (25)$$

The 式 26 for C_{FF} was tested:

$$C_{FF} = \frac{1}{2\pi f_x} \times \frac{1}{\sqrt{R_{FBT} \times (R_{FBT} // R_{FBB})}} \quad (26)$$

If capacitors with high ESR are used C_{FF} is not required. The C_{FF} capacitor creates a time constant with R_{FBT} that couples the attenuated output voltage ripple to the FB node. Using a value that is too large for C_{FF} may couple too much ripple to FB node and affect output voltage regulation. For capacitors with medium ESR (20 – 200 m Ω) 式 26 can be used as quick starting point. For the application in this design example, a 47-pF C0G capacitor is used.

8.2.2.8 Bootstrap Capacitors

Every LM76002-Q1/LM76003-Q1 design requires a bootstrap capacitor, C_{BOOT} . The recommended bootstrap capacitor is 0.47 μ F and rated at 6.3 V or greater. The bootstrap capacitor is located between the SW pin and the BOOT pin. The bootstrap capacitor must be a high-quality ceramic type with X7R or X5R grade dielectric for temperature stability.

8.2.2.9 VCC Capacitors

The VCC pin is the output of an internal LDO for LM76002-Q1/LM76003-Q1. The input for this LDO comes from either VIN or BIAS (please refer to functional block diagram for LM76002-Q1/LM76003-Q1). To insure stability of the part, place a 1- μ F to 2.2- μ F, 10-V capacitor for this pin. Never short VCC pin to ground during operation.

8.2.2.10 BIAS Capacitors

For an output voltage 3.3 V and greater, connect the BIAS pin to the output in order to increase light load efficiency. The BIAS pin is one of the two inputs for the VCC LDO. When BIAS voltage is below $V_{BIAS-ON}$ threshold, the input for the VCC LDO is internally connected to VIN. Because this is an LDO, the voltage differences between the input and output affects the efficiency of the LDO. If necessary, a capacitor with a value of 1 μ F can be added close to the BIAS pin as an input capacitor for the LDO.

8.2.2.11 Soft-Start Capacitors

The SS pin can be left floating, and the LM76002-Q1/LM76003-Q1 implements a soft-start time of 6.3 ms. In order to use an external soft-start capacitor, the capacitor must be sized so that the soft-start time is greater than 6.3 ms. Use 式 27 to calculate the soft-start capacitor value:

$$C_{SS} = I_{SSC} \times t_{SS} \quad (27)$$

With a desired soft-start time of 11 ms, a soft-start charging current of 2 μ A, and an internal V_{REF} of 1 V, 式 27 yields a soft start capacitor value of 22 nF.

8.2.2.12 Undervoltage Lockout Setpoint

The undervoltage lockout (UVLO) is adjusted using the external voltage divider network of R_{ENT} and R_{ENB} . R_{ENT} is connected between the PVIN pin and the EN pin of the LM76002-Q1/LM76003-Q1. R_{ENB} is connected between the EN pin and the GND pin. The UVLO has two thresholds, one for power up when the input voltage is rising and one for power down or brownouts when the input voltage is falling. 式 28 can be used to determine the V_{IN} UVLO level.

$$V_{IN-UVLO-RISING} = V_{ENH} \times (R_{ENB} + R_{ENT}) / R_{ENB} \quad (28)$$

The EN rising threshold (V_{ENH}) for LM76002-Q1/LM76003-Q1 is set to be 1.204 V (typical). Choose the value of R_{ENB} to be 100 k Ω to minimize input current from the supply. If the desired V_{IN} UVLO level is at 5 V, then the value of R_{ENT} can be calculated using 式 29:

$$R_{ENT} = (V_{IN-UVLO-RISING} / V_{ENH} - 1) \times R_{ENB} \quad (29)$$

式 29 yields a value of 315 k Ω . The resulting falling UVLO threshold, can be calculated by 式 30, where EN falling threshold (V_{ENL}) is 1.05 V (typical).

$$V_{IN-UVLO-FALLING} = V_{ENL} \times (R_{ENB} + R_{ENT}) / R_{ENB} \quad (30)$$

8.2.2.13 PGOOD

A typical pullup resistor value is 10 k Ω to 100 k Ω from the PGOOD pin to a voltage no higher than 18 V. If it is desired to pull up the PGOOD pin to a voltage higher than 18 V, a resistor can be added from the PGOOD pin to ground to divide the voltage detected by the PGOOD pin to a value no higher than 18 V.

8.2.2.14 Synchronization

The LM76002-Q1/LM76003-Q1 switching action can synchronize to an external clock from 300 kHz to 2.2 MHz. TI recommends connecting an external clock to the SYNC pin with a 50- Ω to 100- Ω termination resistor. Ground the SYNC pin if not used.

8.2.3 Application Curves

Unless otherwise specified the following conditions apply:

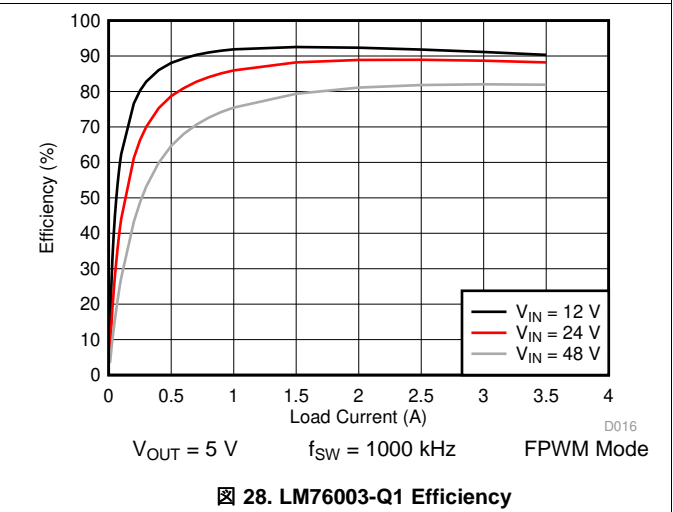
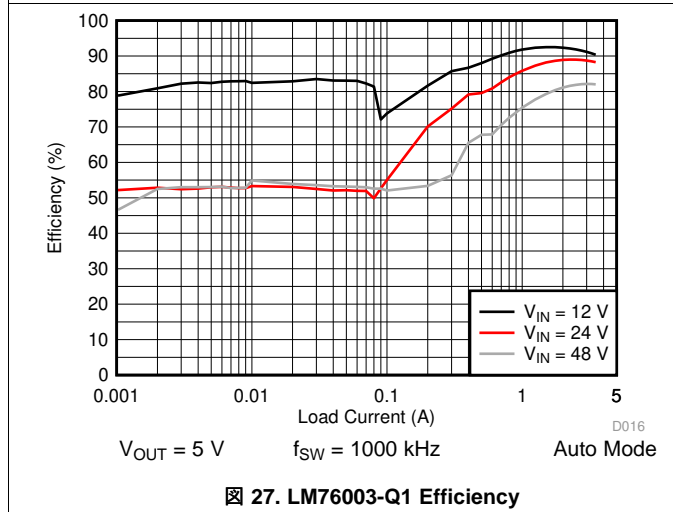
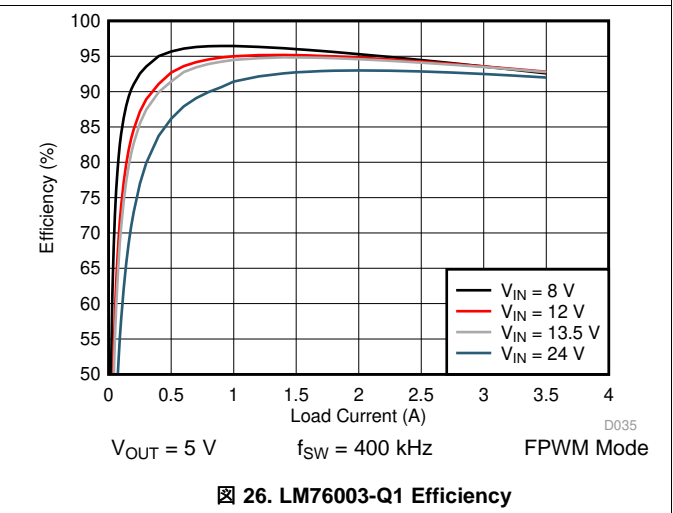
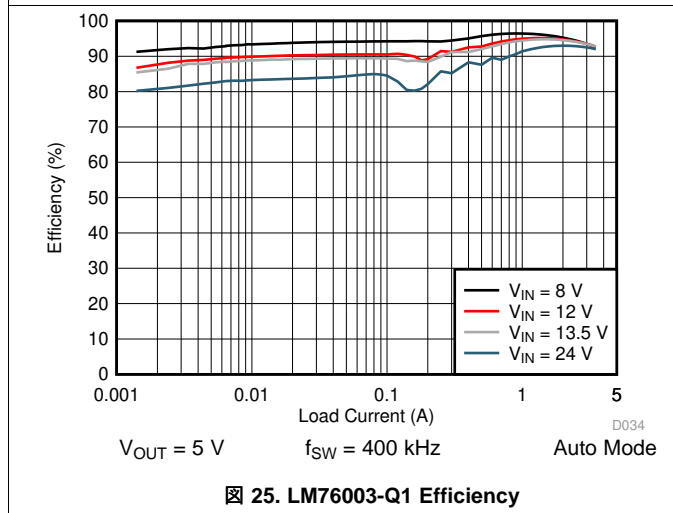
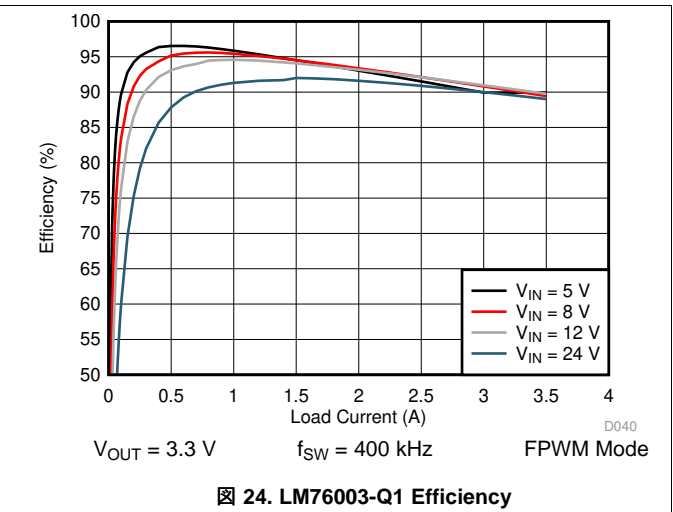
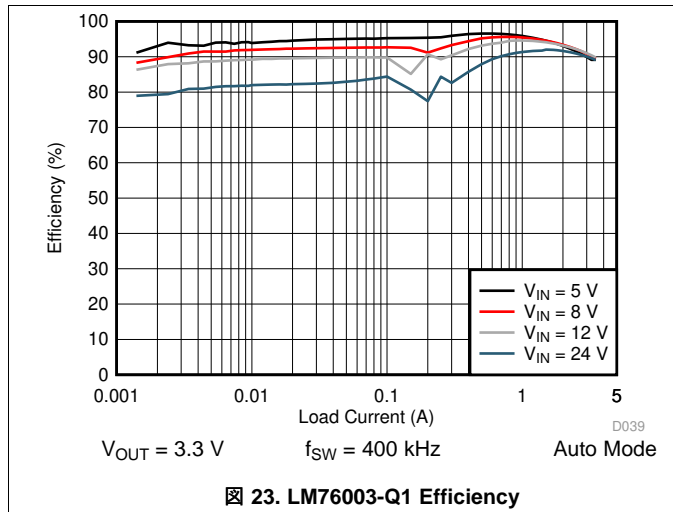

Unless otherwise specified the following conditions apply:

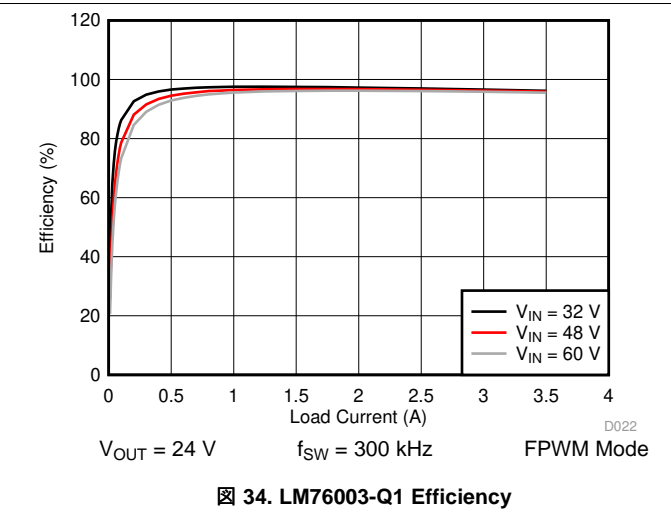
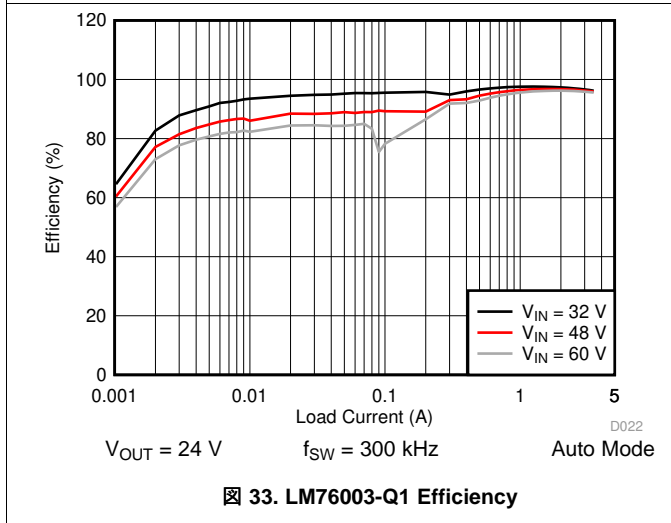
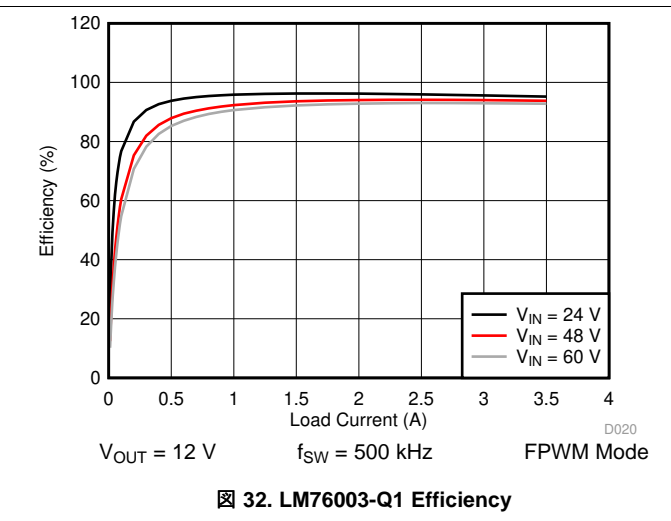
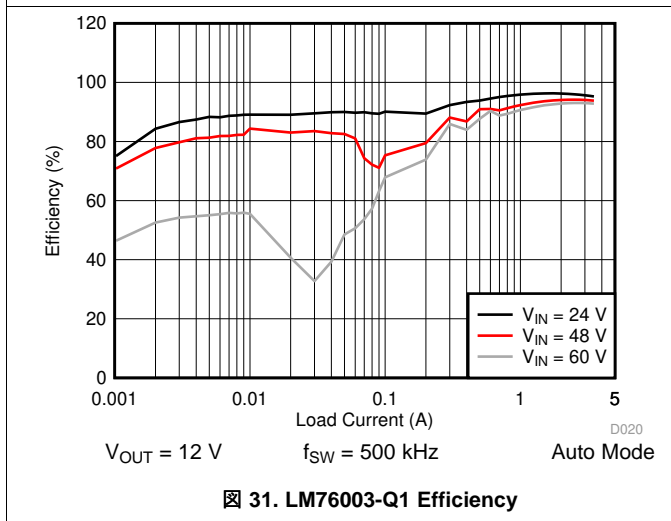
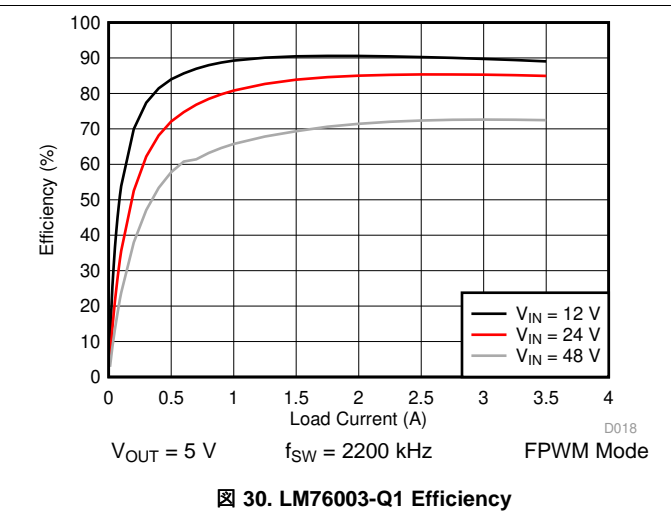
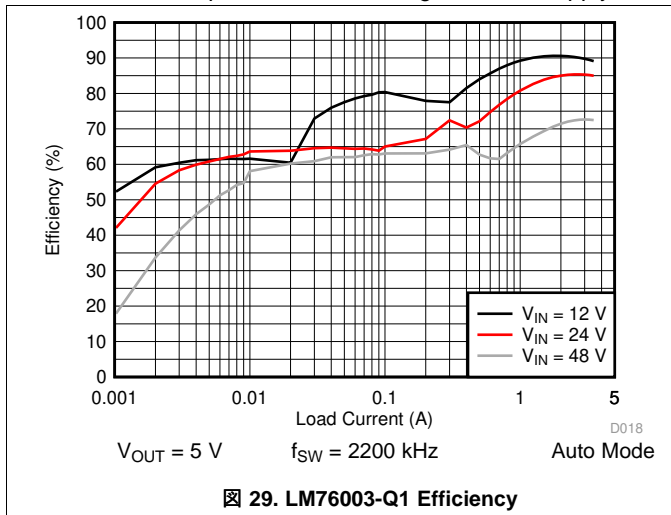

Unless otherwise specified the following conditions apply:

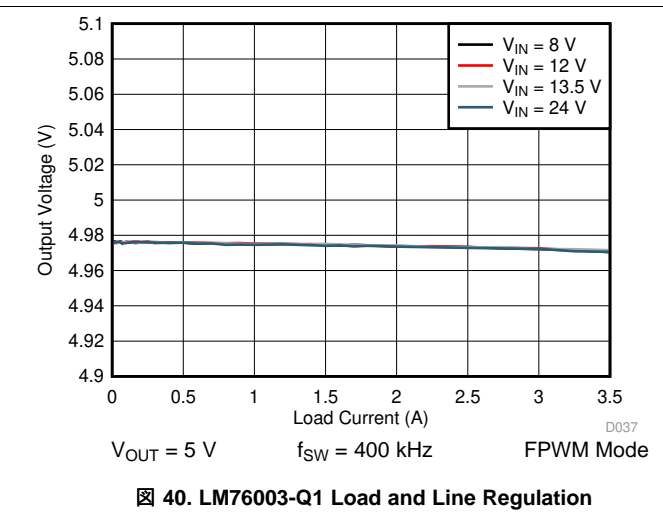
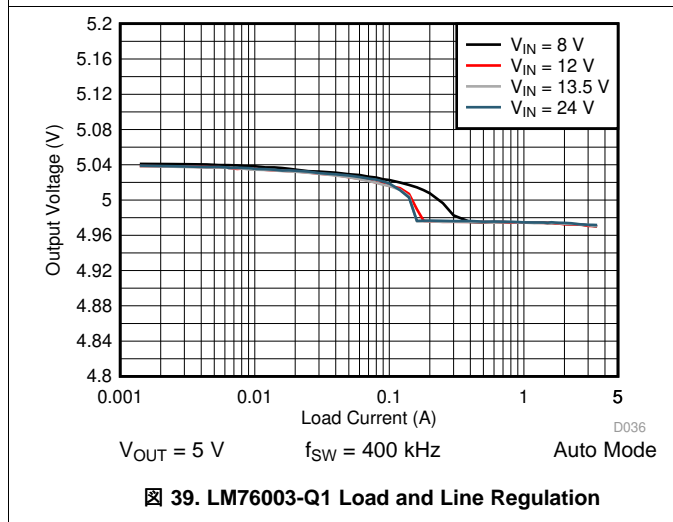
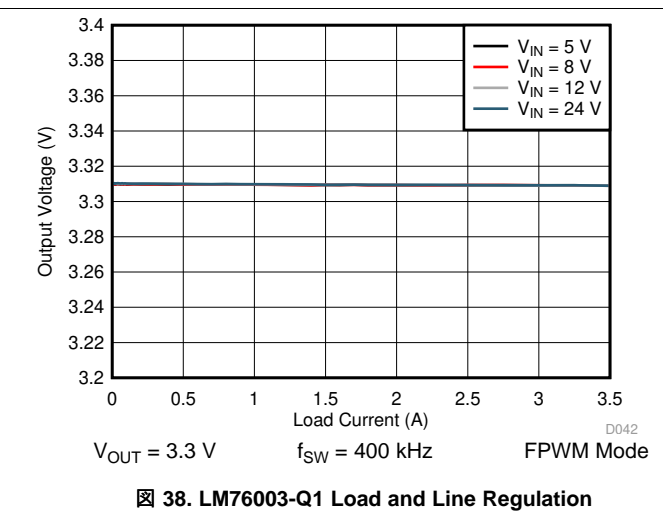
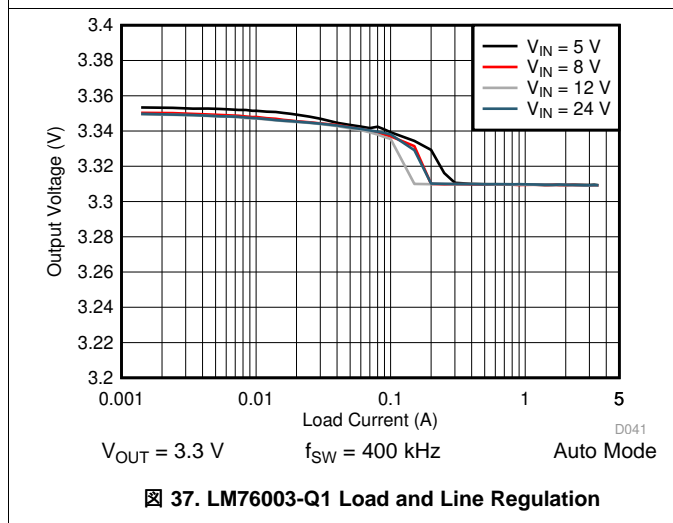
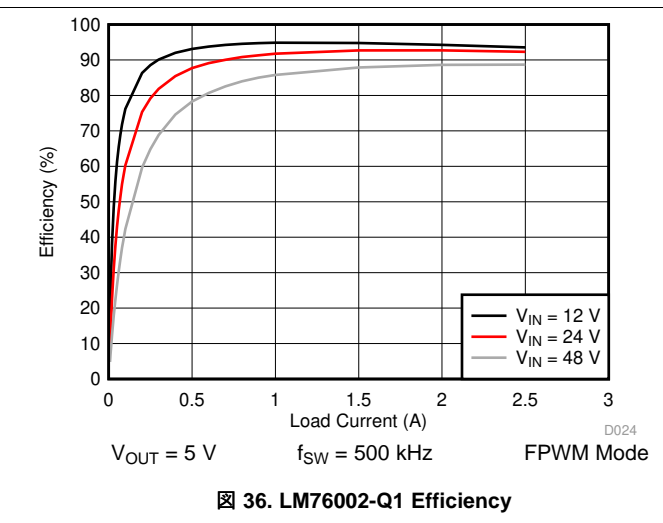
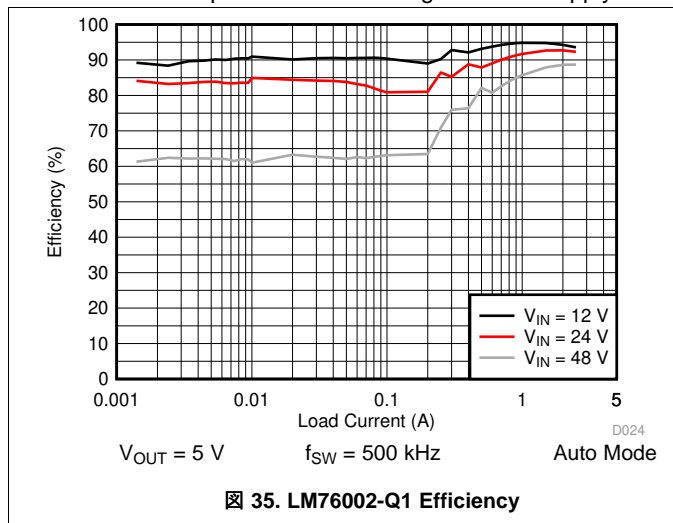

Unless otherwise specified the following conditions apply:

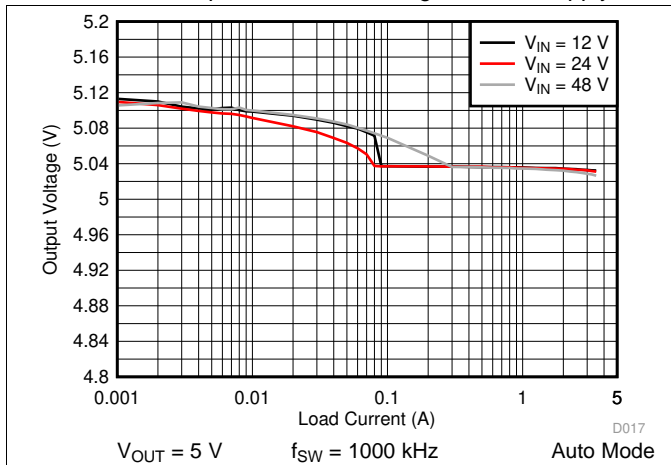

41. LM76003-Q1 Load and Line Regulation

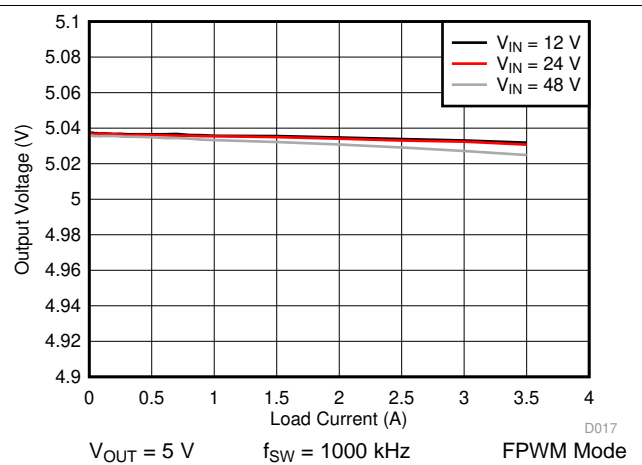

42. LM76003-Q1 Load and Line Regulation

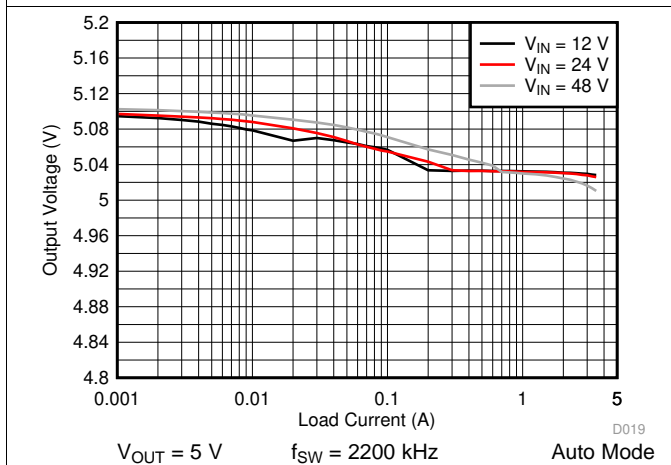

43. LM76003-Q1 Load and Line Regulation

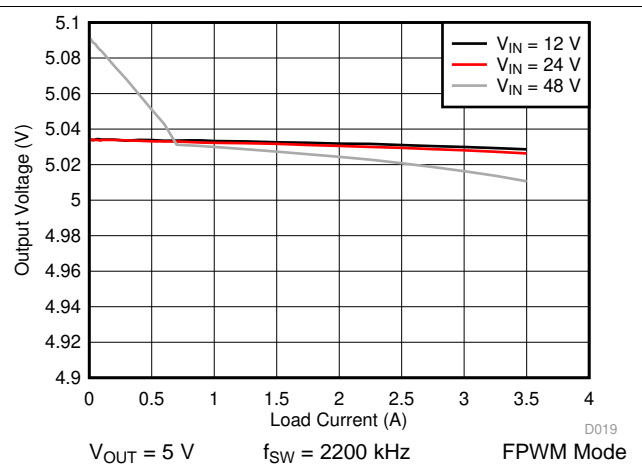

44. LM76003-Q1 Load and Line Regulation

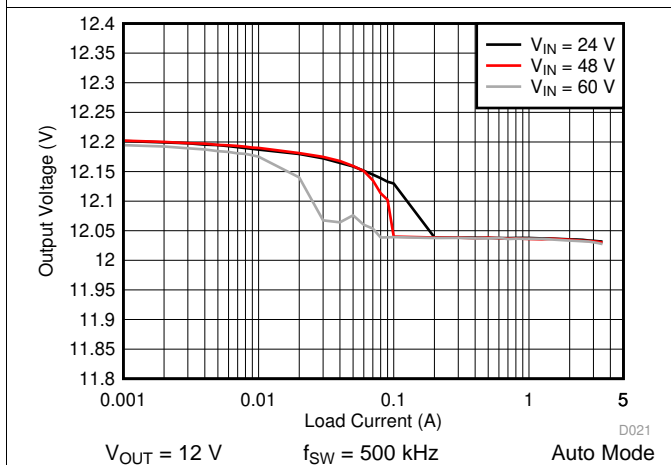

45. LM76003-Q1 Load and Line Regulation

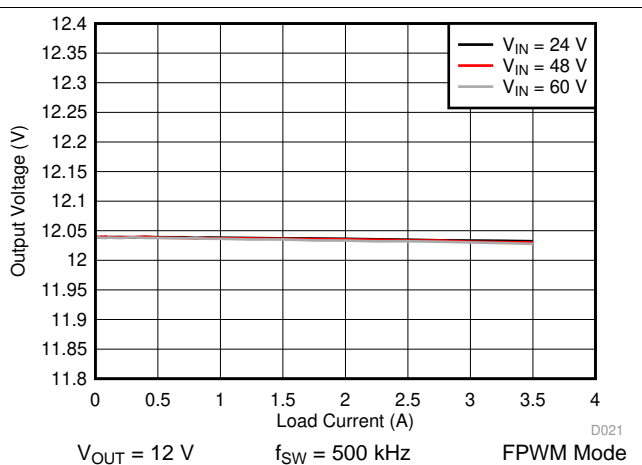

46. LM76003-Q1 Load and Line Regulation

Unless otherwise specified the following conditions apply:



图 47. LM76003-Q1 Load and Line Regulation



图 48. LM76003-Q1 Load and Line Regulation

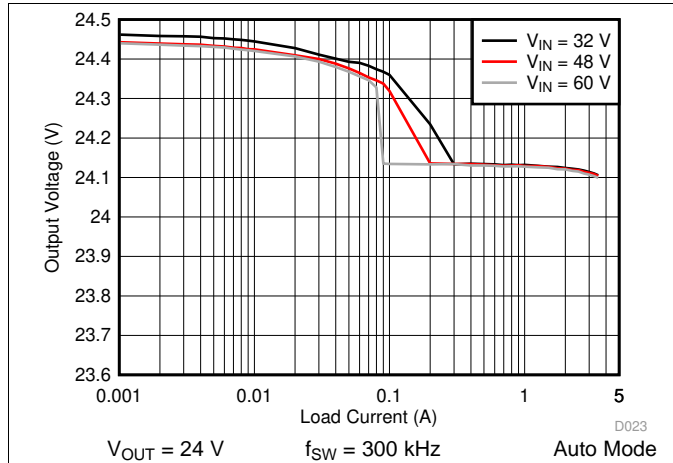

图 49. LM76002-Q1 Load and Line Regulation

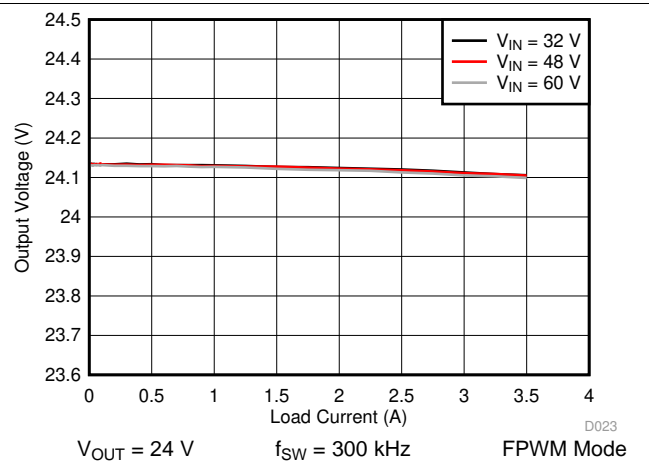

图 50. LM76002-Q1 Load and Line Regulation

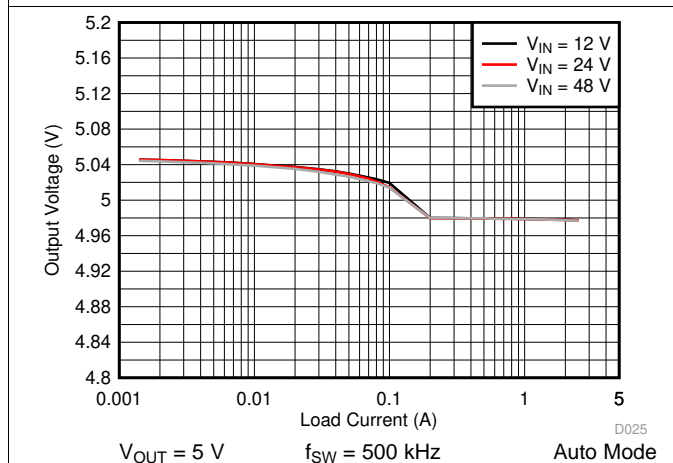

图 51. LM76003-Q1 Dropout Curve

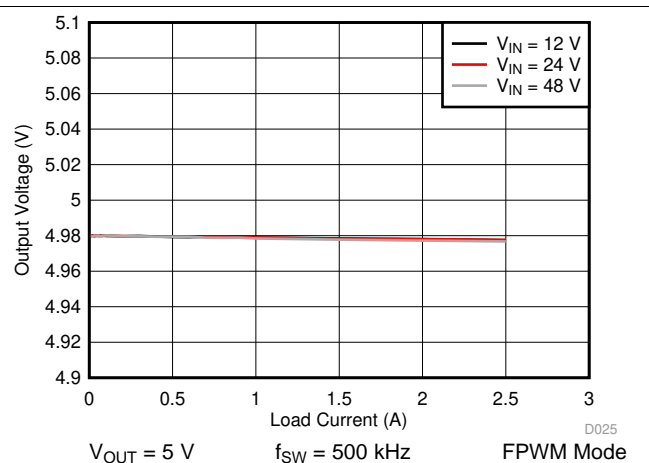

图 52. LM76003-Q1 Dropout Curve

Unless otherwise specified the following conditions apply:

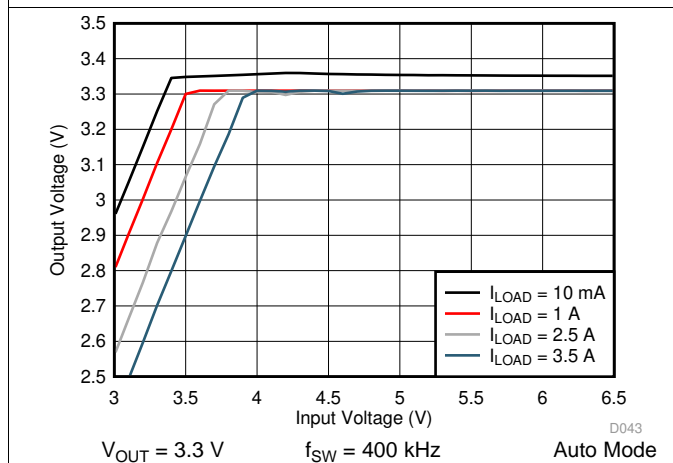

Unless otherwise specified the following conditions apply:

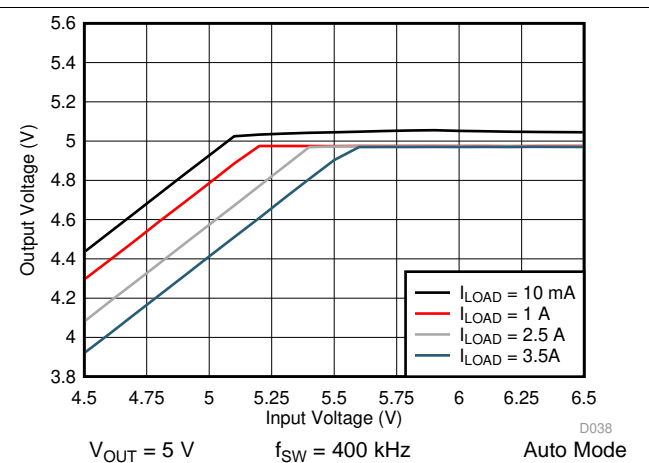
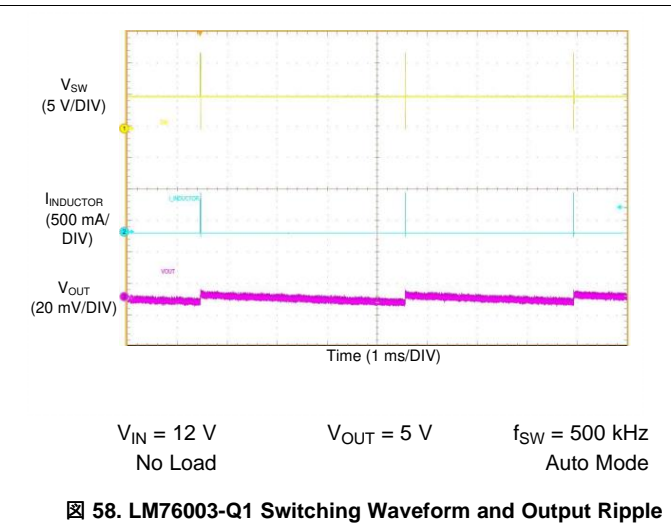
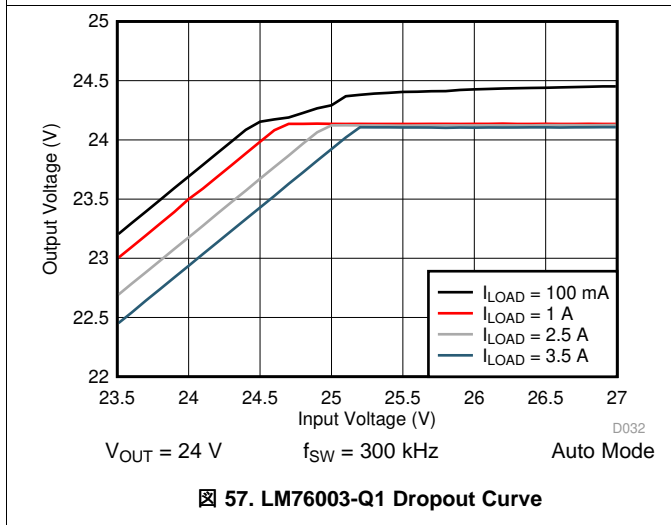
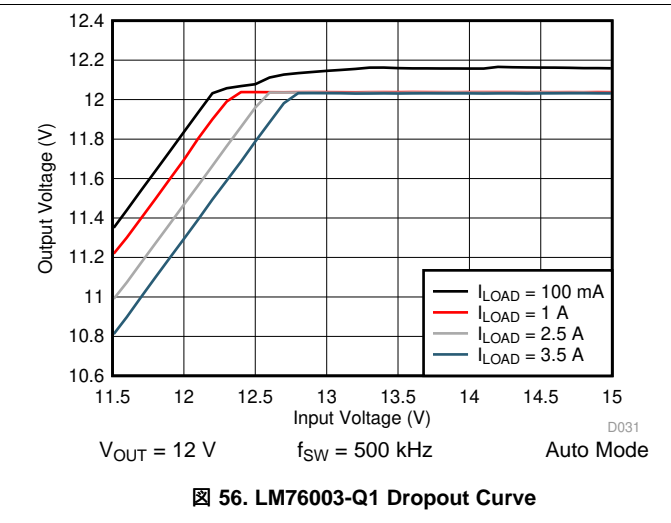
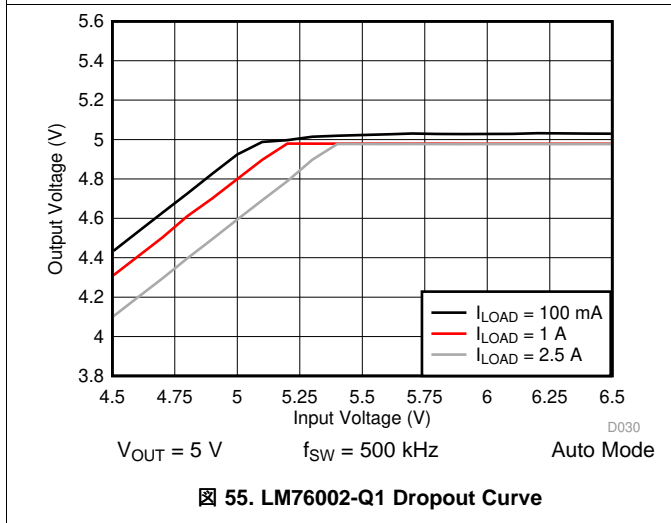
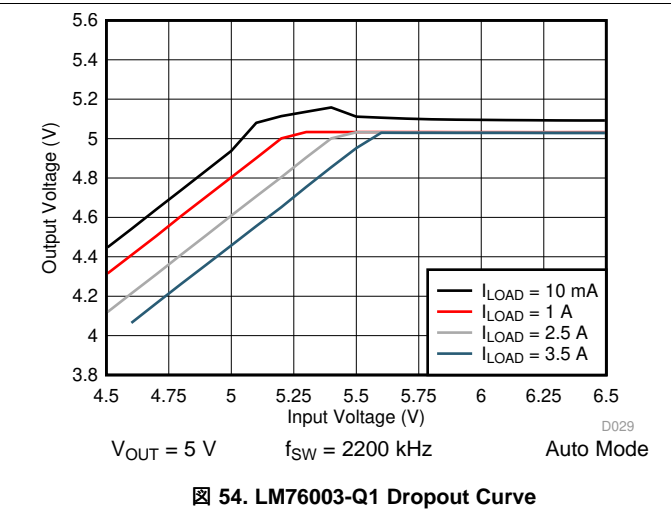
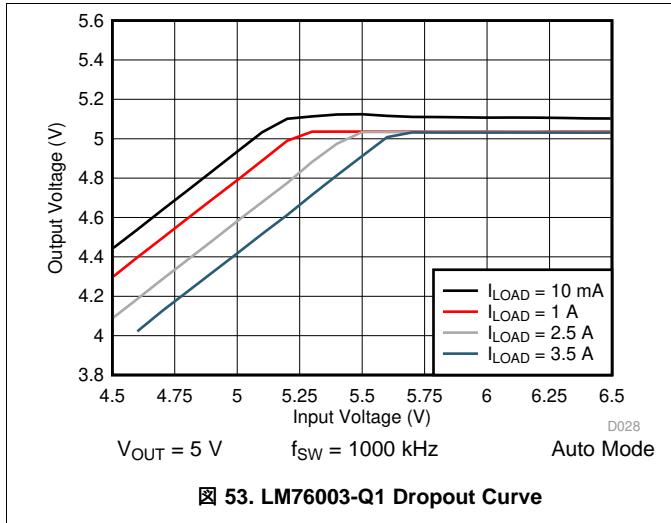
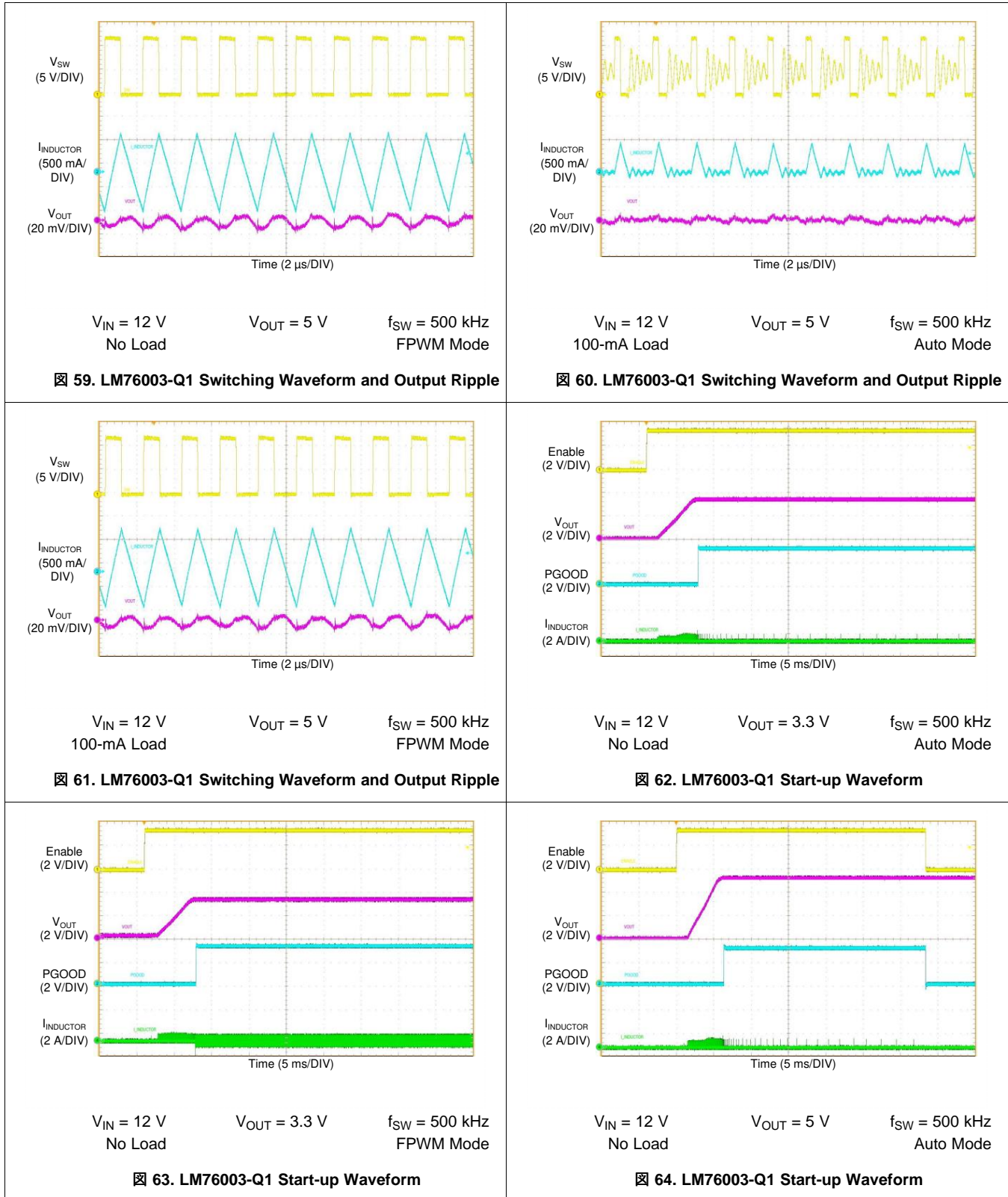

Unless otherwise specified the following conditions apply:

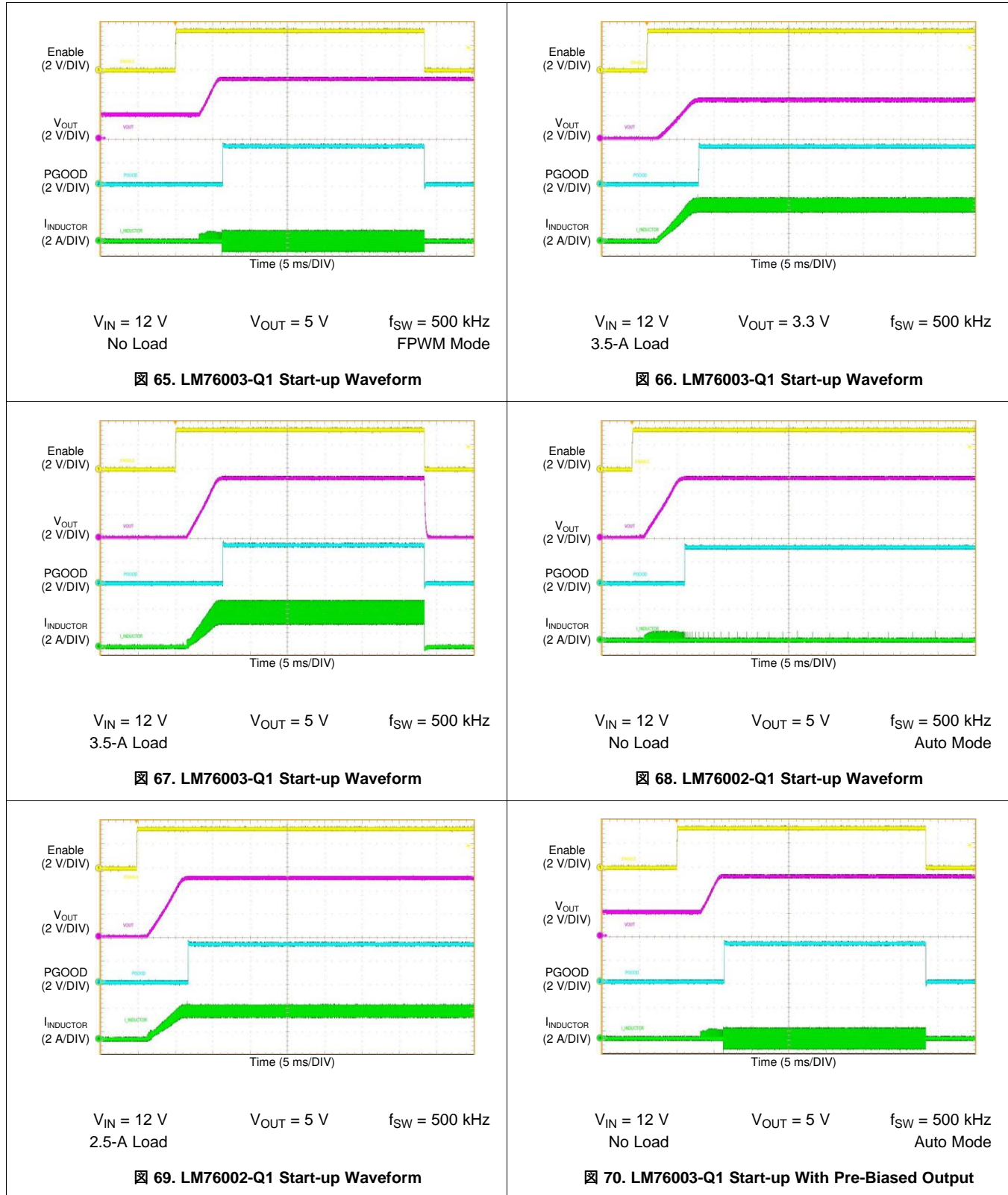

Unless otherwise specified the following conditions apply:

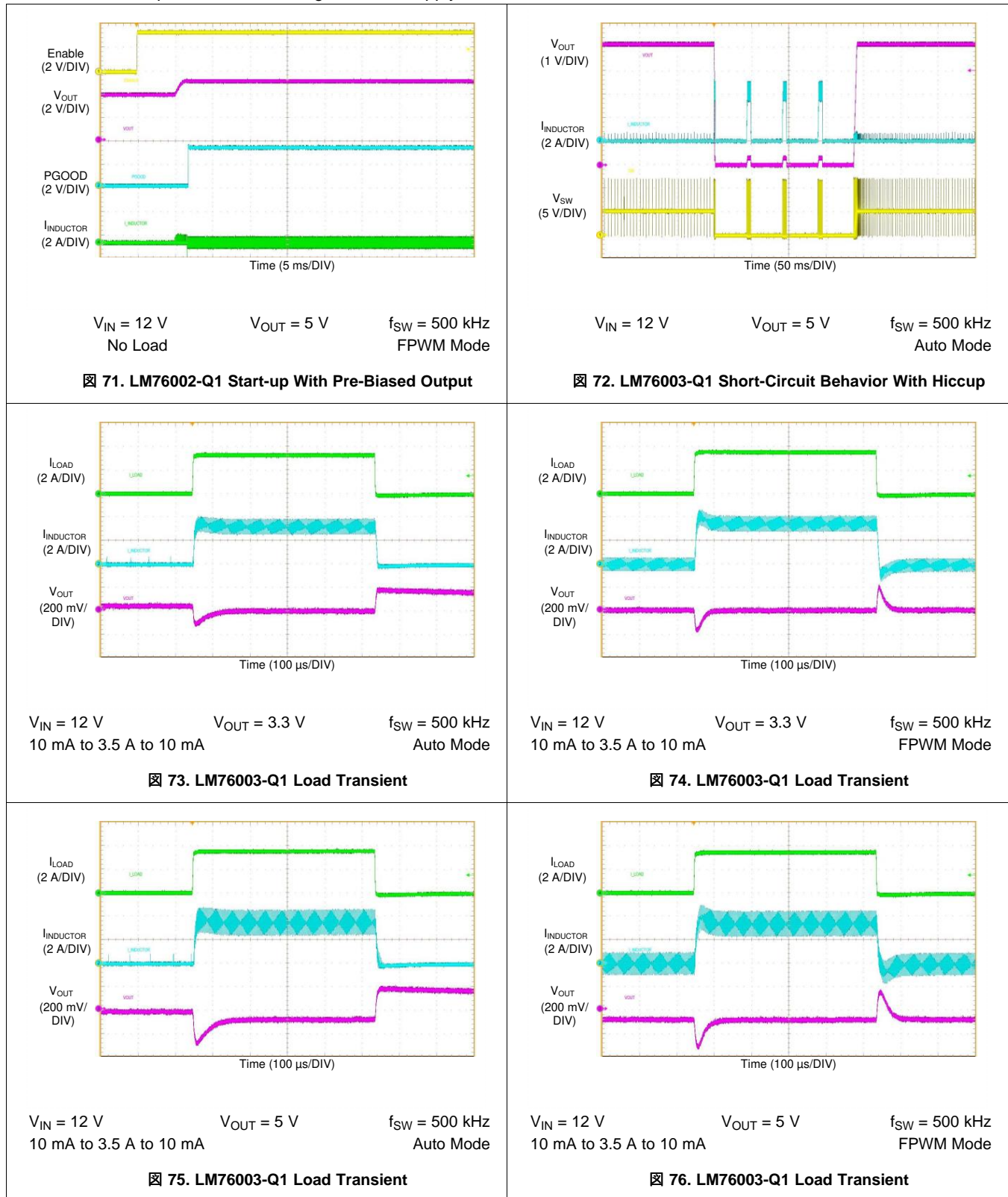

Unless otherwise specified the following conditions apply:

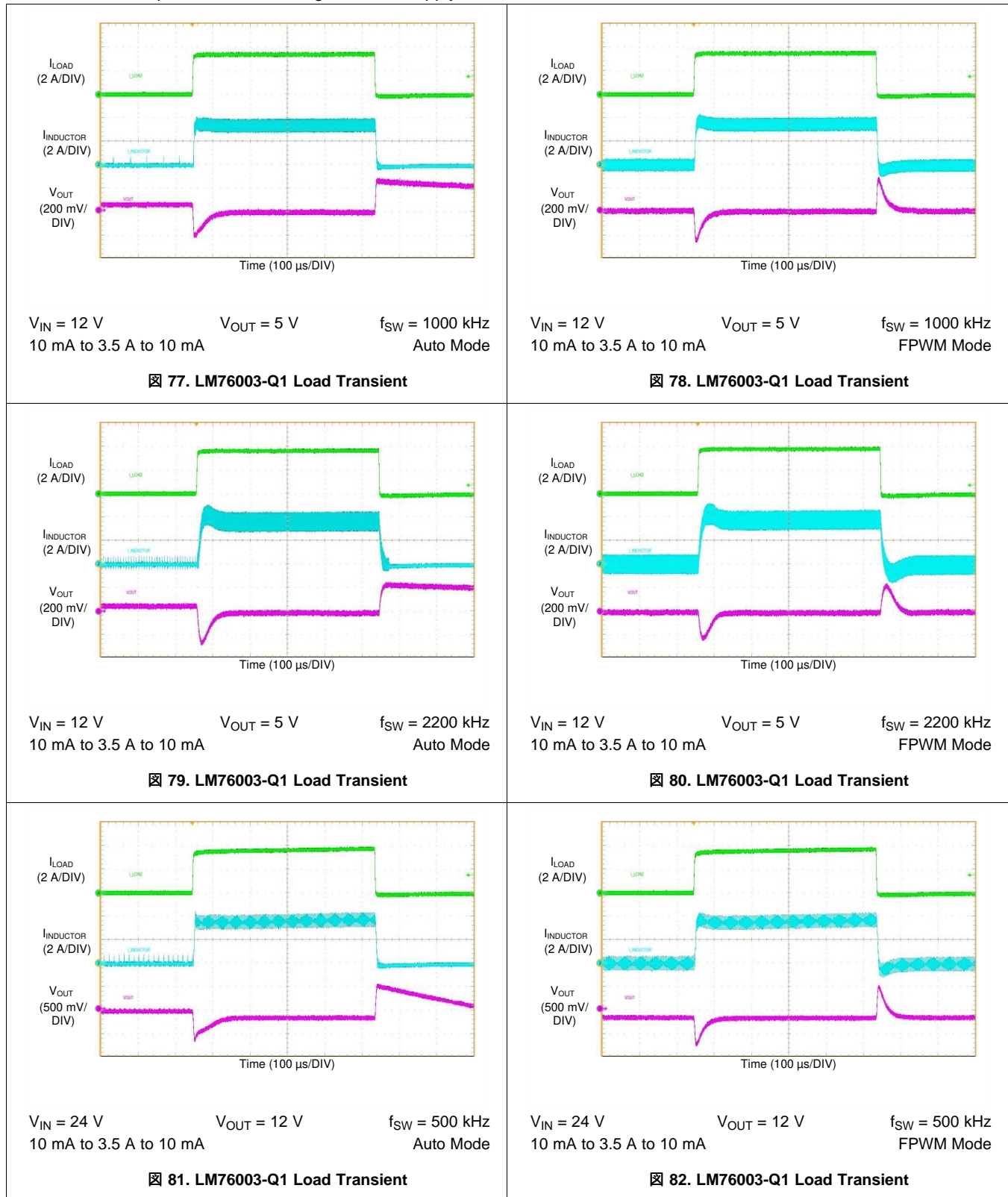

Unless otherwise specified the following conditions apply:

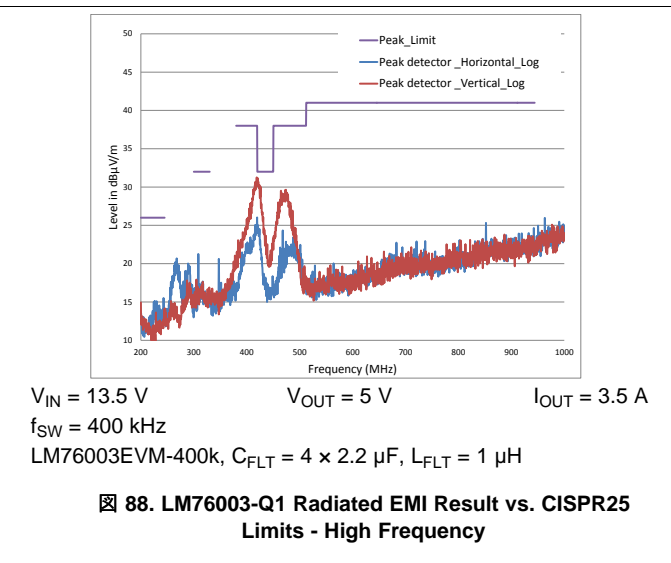
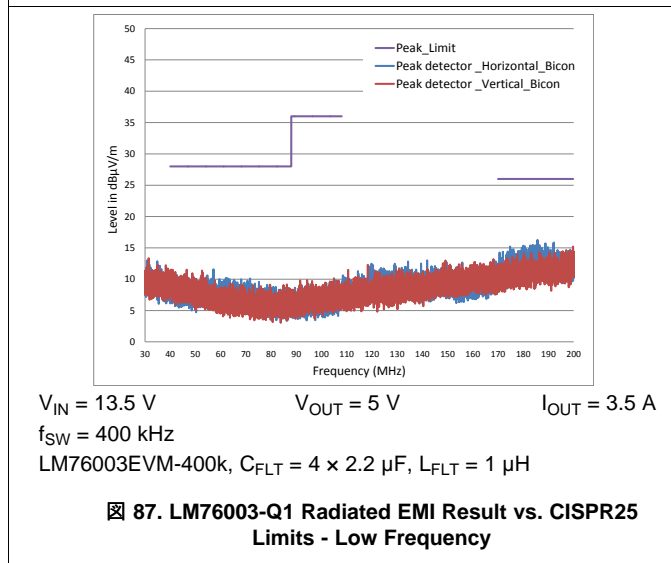
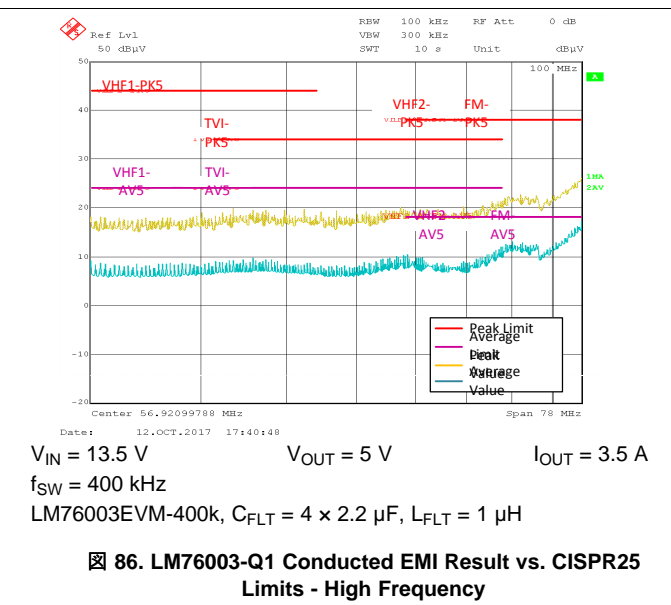
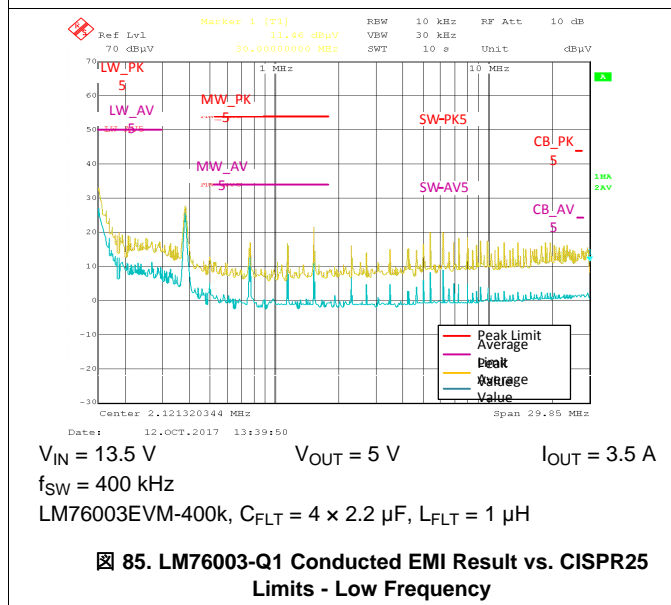
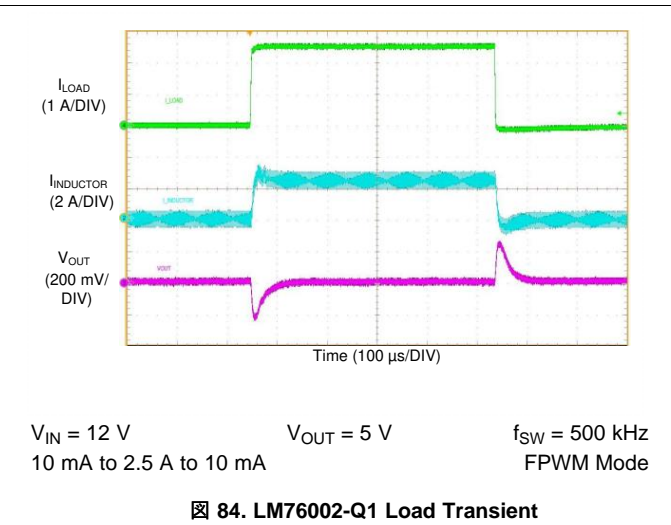
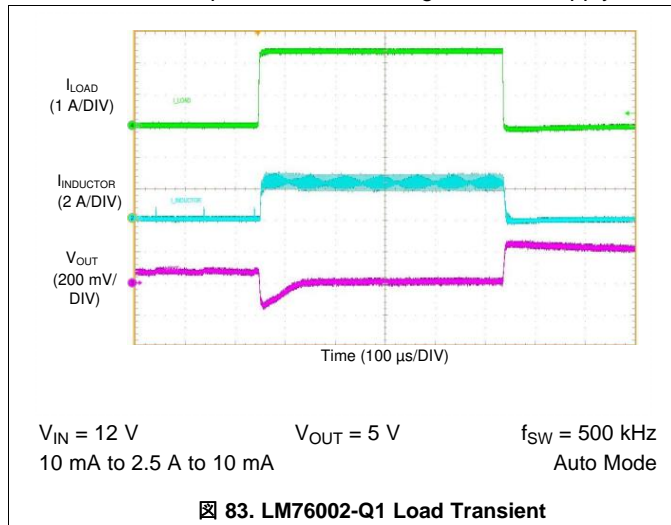

9 Power Supply Recommendations

The LM76002-Q1/LM76003-Q1 is designed to operate from an input voltage supply range between 3.5 V and 60 V. This input supply must be able to withstand the maximum input current and maintain a voltage above 3.5 V. The resistance of the input supply rail must be low enough that an input current transient does not cause a high enough drop at the LM76002 supply voltage that can cause a false UVLO fault triggering and system reset.

If the input supply is located more than a few inches from the LM76002-Q1/LM76003-Q1 additional bulk capacitance may be required in addition to the ceramic bypass capacitors. The amount of bulk capacitance is not critical, but a 47- μ F or 100- μ F electrolytic capacitor is a typical choice.

10 Layout

10.1 Layout Guidelines

The performance of any switching converter depends as much upon the layout of the PCB as the component selection. The following guidelines will help the user design a circuit with maximum rejection of outside EMI and minimum generation of unwanted EMI.

1. Place ceramic high frequency bypass C_{IN} as close as possible to the LM76002-Q1/LM76003-Q1 PVIN and PGND pins. Grounding for both the input and output capacitors should consist of localized top side planes that connect to the PGND pins and PAD.
2. Place bypass capacitors for VCC and BIAS close to the pins and ground the bypass capacitors to device ground.
3. Minimize trace length to the FB pin. Both feedback resistors, R_{FBT} and R_{FBB} must be located close to the FB pin. Place C_{FF} directly in parallel with R_{FBT} . If V_{OUT} accuracy at the load is important, make sure V_{OUT} sense is made at the load. Route V_{OUT} sense path away from noisy nodes and preferably through a layer on the other side of a shielding layer.
4. Use ground plane in one of the middle layers as noise shielding and heat dissipation path. Have a single point ground connection to the plane. Route the ground connections for the feedback, soft start, and enable components to the ground plane. This prevents any switched or load currents from flowing in the analog ground traces. If not properly handled, poor grounding can result in degraded load regulation or erratic output voltage ripple behavior.
5. Make V_{IN} , V_{OUT} and ground bus connections as wide as possible. This reduces any voltage drops on the input or output paths of the converter and maximizes efficiency.
6. Provide adequate device heat-sinking. Use an array of heat-sinking vias to connect the exposed pad to the ground plane on the bottom PCB layer. If the PCB has multiple copper layers, these thermal vias can also be connected to inner layer heat-spreading ground planes. Ensure enough copper area is used for heat-sinking to keep the junction temperature below 125°C.

10.1.1 Layout Highlights

1. Minimize area of switched current loops. From an EMI reduction standpoint, it is imperative to minimize the high di/dt paths during PC board layout as shown in the figure above. The high current loops that do not overlap have high di/dt content that causes observable high frequency noise on the output pin if the input capacitor C_{IN} is placed at a distance away from the LM76002-Q1/LM76003-Q1. Therefore, place C_{IN} as close as possible to the LM76002-Q1/LM76003-Q1 PVIN and PGND pins. This minimizes the high di/dt area and reduce radiated EMI. Additionally, grounding for both the input and output capacitor must consist of a localized top-side plane that connects to the PGND pin.
2. Have a single point ground. The ground connections for the feedback, soft-start, and enable components should be routed to the AGND pin of the device. This prevents any switched or load currents from flowing in the analog ground traces. If not properly handled, poor grounding can result in degraded load regulation or erratic output voltage ripple behavior.
3. Minimize trace length to the FB pin net. Place both feedback resistors, R_{FBT} and R_{FBB} , close to the FB pin. Because the FB node is high impedance, maintain the copper area as small as possible. Route the traces from R_{FBT} , R_{FBB} away from the body of the LM76002-Q1/LM76003-Q1 to minimize possible noise pickup. Place C_{ff} directly in parallel with R_{FBT} .
4. Make input and output bus connections as wide as possible. This reduces any voltage drops on the input or output of the converter and maximizes efficiency. To optimize voltage accuracy at the load, ensure that a

Layout Guidelines (continued)

separate feedback voltage sense trace is made to the load. Doing so corrects for voltage drops and provide optimum output accuracy.

- Provide adequate device heat-sinking. Use an array of heat-sinking vias to connect the exposed pad to the ground plane on the bottom PCB layer. If the PCB has multiple copper layers, these thermal vias can also be connected to inner layer heat-spreading ground planes. For best results use a 10 × 10 via array (or greater) with a minimum via diameter of 12 mil thermal vias spaced 46.8 mil apart. Ensure enough copper area is used for heat-sinking to keep the junction temperature below 125°C.

10.1.2 Compact Layout for EMI Reduction

Radiated EMI is generated by the high di/dt components in pulsing currents in switching converters. The larger area covered by the path of a pulsing current, the more electromagnetic emission is generated. The key to minimize radiated EMI is to identify the pulsing current path and minimize the area of the path. In Buck converters, the pulsing current path is from the V_{IN} side of the input capacitors to HS switch, to the LS switch, and then return to the ground of the input capacitors, as shown in [Figure 89](#).

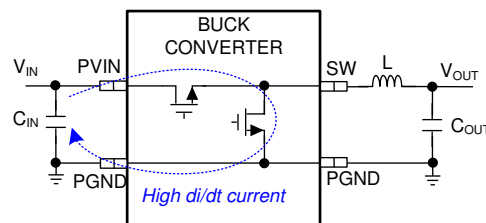

Figure 89. Buck Converter High di/dt Path

High frequency ceramic bypass capacitors at the input side provide primary path for the high di/dt components of the pulsing current. Placing ceramic bypass capacitor(s) as close as possible to the PVIN and PGND pins is the key to EMI reduction. The SW pin connecting to the inductor should be as short as possible, and just wide enough to carry the load current without excessive heating. Short, thick traces or copper pours (shapes) should be used for high current conduction path to minimize parasitic resistance. The output capacitors should be placed close to the V_{OUT} end of the inductor and closely grounded to PGND pin and exposed PAD. Place the bypass capacitors on VCC and BIAS pins as close as possible to the pins respectively and closely grounded to PGND and the exposed PAD.

10.1.3 Ground Plane and Thermal Considerations

TI recommends using one of the middle layers as a solid ground plane. Ground plane provides shielding for sensitive circuits and traces. It also provides a quiet reference potential for the control circuitry. Connect the AGND and PGND pins to the ground plane using vias right next to the bypass capacitors. PGND pins are connected to the source of the internal LS switch; connect the PGND pins directly to the grounds of the input and output capacitors. The PGND net contains noise at the switching frequency and may bounce due to load variations. The PGND trace, as well as PVIN and SW traces, should be constrained to one side of the ground plane. The other side of the ground plane contains much less noise — use for sensitive routes.

Provide adequate device heat sinking by utilizing the PAD of the device as the primary thermal path. Use a minimum 4 by 4 array of 10 mil thermal vias to connect the PAD to the system ground plane for heat sinking. Distribute the vias evenly under the PAD. Use as much copper as possible for system ground plane on the top and bottom layers for the best heat dissipation. TI recommends using a four-layer board with the copper thickness, for the four layers, starting from the top one, 2 oz / 1 oz / 1 oz / 2 oz. Four layer boards with enough copper thickness and proper layout provides low current conduction impedance, proper shielding and lower thermal resistance.

The thermal characteristics of the LM76002-Q1/LM76003-Q1 are specified using the parameter $R_{\theta JA}$, which characterize the junction temperature of the silicon to the ambient temperature in a specific system. Although the value of $R_{\theta JA}$ is dependant on many variables, it still can be used to approximate the operating junction temperature of the device.

To obtain an estimate of the device junction temperature, one may use the following relationship:

Layout Guidelines (continued)

$$T_J = P_D \times R_{\theta JA} + T_A$$

where

- T_J = junction temperature in °C
- $P_D = V_{IN} \times I_{IN} \times (1 - \text{efficiency}) - 1.1 \times I_{OUT} \times \text{DCR}$
- DCR = inductor DC parasitic resistance in Ω
- $R_{\theta JA}$ = junction-to-ambient thermal resistance of the device in °C/W
- T_A = ambient temperature in °C.

(31)

The maximum operating junction temperature of the LM76002-Q1/LM76003-Q1 is 125°C. $R_{\theta JA}$ is highly related to PCB size and layout, as well as environmental factors such as heat sinking and air flow. [Figure 90](#) shows measured results of $R_{\theta JA}$ with different copper area on a 2-layer board and a 4-layer board.

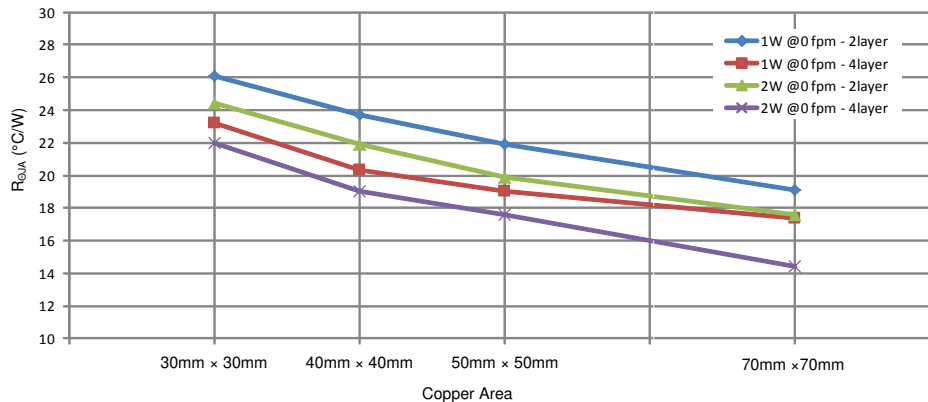

Figure 90. Measured $R_{\theta JA}$ vs PCB Copper Area on a 2-Layer Board and a 4-Layer Board

10.1.4 Feedback Resistors

To reduce noise sensitivity of the output voltage feedback path, it is important to place the resistor divider and C_{FF} close to the FB pin, rather than close to the load. The FB pin is the input to the error amplifier, so it is a high impedance node and very sensitive to noise. Placing the resistor divider and C_{FF} closer to the FB pin reduces the trace length of FB signal and reduces noise coupling. The output node is a low impedance node, so the trace from V_{OUT} to the resistor divider can be long if short path is not available.

If voltage accuracy at the load is important, make sure voltage sense is made at the load. Doing so corrects for voltage drops along the traces and provide the best output accuracy. The voltage sense trace from the load to the feedback resistor divider should be routed away from the SW node path, the inductor and VIN path to avoid contaminating the feedback signal with switch noise, while also minimizing the trace length. This is most important when high value resistors are used to set the output voltage. TI recommends routing the voltage sense trace on a different layer than the inductor, SW node and VIN path, such that there is a ground plane in between the feedback trace and inductor / SW node / VIN polygon. This provides further shielding for the voltage feedback path from switching noises.

10.2 Layout Example

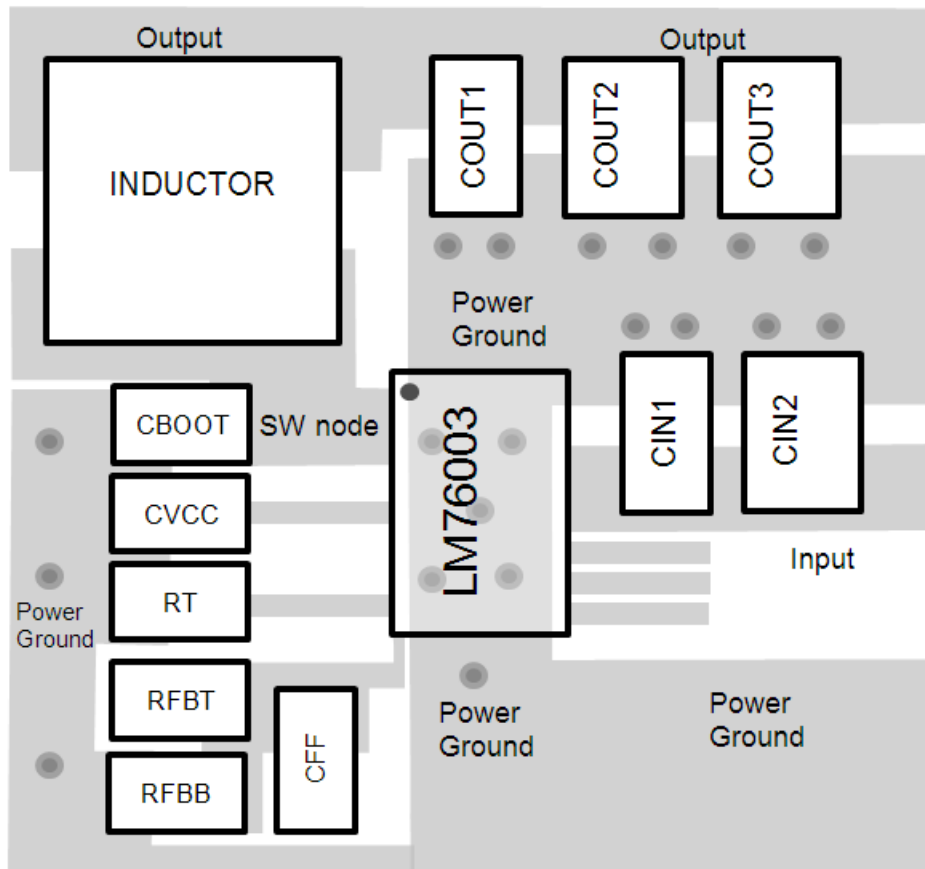

91. LM76002-Q1/LM76003-Q1 Layout

10.3 Thermal Design

When calculating module dissipation use the maximum input voltage and the average output current for the application. Many common operating conditions are provided in the characteristic curves such that less common applications can be derived through interpolation. In all designs, the junction temperature must be kept below the rated maximum of 125°C. For the design case of $V_{IN} = 12\text{ V}$, $V_{OUT} = 5\text{ V}$, $I_{OUT} = 3.5\text{ A}$, $f_{SW} = 2100\text{ kHz}$, and $T_{A-MAX} = 85^\circ\text{C}$, the device must detect a thermal resistance from exposed pad (case) to ambient ($R_{\theta CA}$):

$$R_{\theta CA} < \frac{T_{J-MAX} - T_{A-MAX}}{P_{IC-LOSS}} - R_{\theta CA} \quad (32)$$

The typical thermal impedance from junction to case is 1.7°C/W. Use the 125°C power dissipation curves in [Typical Characteristics](#) section to estimate the $P_{IC-LOSS}$ for the application being designed. In this application it is 3 W. The inductor losses must be subtracted from this number and can be estimated as:

$$R_{\theta CA} < \frac{125^\circ\text{C} - 85^\circ\text{C}}{2.75\text{ W}} - 1.7^\circ\text{C/W} < 12.84^\circ\text{C/W} \quad (33)$$

To reach $R_{\theta CA} = 12.84^\circ\text{C/W}$, the PCB is required to dissipate heat effectively. With no airflow and no external heat-sink, a good estimate of the required board area covered by 2 oz. copper on both the top and bottom metal layers is:

$$\text{Board Area}_{\text{cm}^2} \leq \frac{500}{R_{\theta CA}} \times \frac{^\circ\text{C} \times \text{cm}^2}{\text{W}} \quad (34)$$

As a result, approximately 38.95 square cm of 2 oz. copper on top and bottom layers is the minimum required area for the example PCB design. This is a 6.25 cm (2.45 inch) square. The PCB copper heat sink must be connected to the pins of the device and to the exposed pad with multiple thermal vias to the bottom copper. For an example of a high thermal performance PCB layout refer to [AN-2020 Thermal Design By Insight, Not Hindsight](#) and the evaluation board documentation.

11 デバイスおよびドキュメントのサポート

11.1 デバイス・サポート

11.1.1 開発サポート

11.1.1.1 WEBENCH®ツールによるカスタム設計

[ここをクリック](#)すると、WEBENCH® Power Designerにより、LM76002-Q1またはLM76003-Q1を使用するカスタム設計を作成できます。

1. 最初に、入力電圧(V_{IN})、出力電圧(V_{OUT})、出力電流(I_{OUT})の要件を入力します。
2. オプティマイザのダイヤルを使用して、効率、占有面積、コストなどの主要なパラメータについて設計を最適化します。
3. 生成された設計を、テキサス・インスツルメンツが提供する他の方式と比較します。

WEBENCH Power Designerでは、カスタマイズされた回路図と部品リストを、リアルタイムの価格と部品の在庫情報と併せて参照できます。

通常、次の操作を実行可能です。

- 電氣的なシミュレーションを実行し、重要な波形と回路の性能を確認する。
- 熱シミュレーションを実行し、基板の熱特性を把握する。
- カスタマイズされた回路図やレイアウトを、一般的なCADフォーマットで出力する。
- 設計のレポートをPDFで印刷し、設計を共有する。

WEBENCHツールの詳細は、www.ti.com/WEBENCHでご覧になれます。

11.2 ドキュメントの更新通知を受け取る方法

ドキュメントの更新についての通知を受け取るには、ti.comのデバイス製品フォルダを開いてください。右上の「アラートを受け取る」をクリックして登録すると、変更されたすべての製品情報に関するダイジェストを毎週受け取れます。変更の詳細については、修正されたドキュメントに含まれている改訂履歴をご覧ください。

11.3 サポート・リソース

[TI E2E™ support forums](#) are an engineer's go-to source for fast, verified answers and design help — straight from the experts. Search existing answers or ask your own question to get the quick design help you need.

Linked content is provided "AS IS" by the respective contributors. They do not constitute TI specifications and do not necessarily reflect TI's views; see TI's [Terms of Use](#).

11.4 商標

E2E is a trademark of Texas Instruments.

WEBENCH is a registered trademark of Texas Instruments.

All other trademarks are the property of their respective owners.

11.5 静電気放電に関する注意事項



これらのデバイスは、限定的なESD(静電破壊)保護機能を内蔵しています。保存時または取り扱い時は、MOSゲートに対する静電破壊を防止するために、リード線同士をショートさせておくか、デバイスを導電フォームに入れる必要があります。

11.6 Glossary

[SLYZ022](#) — TI Glossary.

This glossary lists and explains terms, acronyms, and definitions.

12 メカニカル、パッケージ、および注文情報

以降のページには、メカニカル、パッケージ、および注文に関する情報が記載されています。この情報は、そのデバイスについて利用可能な最新のデータです。このデータは予告なく変更されることがあり、ドキュメントが改訂される場合もあります。本データシートのブラウザ版を使用されている場合は、画面左側の説明をご覧ください。

PACKAGING INFORMATION

Orderable Device	Status (1)	Package Type	Package Drawing	Pins	Package Qty	Eco Plan (2)	Lead finish/ Ball material (6)	MSL Peak Temp (3)	Op Temp (°C)	Device Marking (4/5)	Samples
LM76002QRNPRQ1	ACTIVE	WQFN	RNP	30	3000	RoHS & Green	NIPDAU SN	Level-2-260C-1 YEAR	-40 to 125	LM76002R NPQ1	Samples
LM76002QRNPTQ1	ACTIVE	WQFN	RNP	30	250	RoHS & Green	NIPDAU SN	Level-2-260C-1 YEAR	-40 to 125	LM76002R NPQ1	Samples
LM76003QRNPRQ1	ACTIVE	WQFN	RNP	30	3000	RoHS & Green	NIPDAU SN	Level-2-260C-1 YEAR	-40 to 125	LM76003R NPQ1	Samples
LM76003QRNPTQ1	ACTIVE	WQFN	RNP	30	250	RoHS & Green	NIPDAU SN	Level-2-260C-1 YEAR	-40 to 125	LM76003R NPQ1	Samples

(1) The marketing status values are defined as follows:

ACTIVE: Product device recommended for new designs.

LIFEBUY: TI has announced that the device will be discontinued, and a lifetime-buy period is in effect.

NRND: Not recommended for new designs. Device is in production to support existing customers, but TI does not recommend using this part in a new design.

PREVIEW: Device has been announced but is not in production. Samples may or may not be available.

OBSELETE: TI has discontinued the production of the device.

(2) **RoHS:** TI defines "RoHS" to mean semiconductor products that are compliant with the current EU RoHS requirements for all 10 RoHS substances, including the requirement that RoHS substance do not exceed 0.1% by weight in homogeneous materials. Where designed to be soldered at high temperatures, "RoHS" products are suitable for use in specified lead-free processes. TI may reference these types of products as "Pb-Free".

RoHS Exempt: TI defines "RoHS Exempt" to mean products that contain lead but are compliant with EU RoHS pursuant to a specific EU RoHS exemption.

Green: TI defines "Green" to mean the content of Chlorine (Cl) and Bromine (Br) based flame retardants meet JS709B low halogen requirements of <=1000ppm threshold. Antimony trioxide based flame retardants must also meet the <=1000ppm threshold requirement.

(3) MSL, Peak Temp. - The Moisture Sensitivity Level rating according to the JEDEC industry standard classifications, and peak solder temperature.

(4) There may be additional marking, which relates to the logo, the lot trace code information, or the environmental category on the device.

(5) Multiple Device Markings will be inside parentheses. Only one Device Marking contained in parentheses and separated by a "~" will appear on a device. If a line is indented then it is a continuation of the previous line and the two combined represent the entire Device Marking for that device.

(6) Lead finish/Ball material - Orderable Devices may have multiple material finish options. Finish options are separated by a vertical ruled line. Lead finish/Ball material values may wrap to two lines if the finish value exceeds the maximum column width.

Important Information and Disclaimer:The information provided on this page represents TI's knowledge and belief as of the date that it is provided. TI bases its knowledge and belief on information provided by third parties, and makes no representation or warranty as to the accuracy of such information. Efforts are underway to better integrate information from third parties. TI has taken and

continues to take reasonable steps to provide representative and accurate information but may not have conducted destructive testing or chemical analysis on incoming materials and chemicals. TI and TI suppliers consider certain information to be proprietary, and thus CAS numbers and other limited information may not be available for release.

In no event shall TI's liability arising out of such information exceed the total purchase price of the TI part(s) at issue in this document sold by TI to Customer on an annual basis.

OTHER QUALIFIED VERSIONS OF LM76002-Q1, LM76003-Q1 :

- Catalog : [LM76002](#), [LM76003](#)

NOTE: Qualified Version Definitions:

- Catalog - TI's standard catalog product

TAPE AND REEL INFORMATION

QUADRANT ASSIGNMENTS FOR PIN 1 ORIENTATION IN TAPE

*All dimensions are nominal

Device	Package Type	Package Drawing	Pins	SPQ	Reel Diameter (mm)	Reel Width W1 (mm)	A0 (mm)	B0 (mm)	K0 (mm)	P1 (mm)	W (mm)	Pin1 Quadrant
LM76002QRNPRQ1	WQFN	RNP	30	3000	330.0	12.4	4.3	6.3	1.1	8.0	12.0	Q1
LM76002QRNPTQ1	WQFN	RNP	30	250	180.0	12.4	4.3	6.3	1.1	8.0	12.0	Q1
LM76003QRNPRQ1	WQFN	RNP	30	3000	330.0	12.4	4.3	6.3	1.1	8.0	12.0	Q1
LM76003QRNPTQ1	WQFN	RNP	30	250	180.0	12.4	4.3	6.3	1.1	8.0	12.0	Q1

TAPE AND REEL BOX DIMENSIONS

*All dimensions are nominal

Device	Package Type	Package Drawing	Pins	SPQ	Length (mm)	Width (mm)	Height (mm)
LM76002QRNPRQ1	WQFN	RNP	30	3000	367.0	367.0	35.0
LM76002QRNPTQ1	WQFN	RNP	30	250	210.0	185.0	35.0
LM76003QRNPRQ1	WQFN	RNP	30	3000	367.0	367.0	35.0
LM76003QRNPTQ1	WQFN	RNP	30	250	210.0	185.0	35.0

GENERIC PACKAGE VIEW

RNP 30

WQFN - 0.8 mm max height

4 x 6, 0.5 mm pitch

PLASTIC QUAD FLATPACK - NO LEAD

This image is a representation of the package family, actual package may vary.
Refer to the product data sheet for package details.

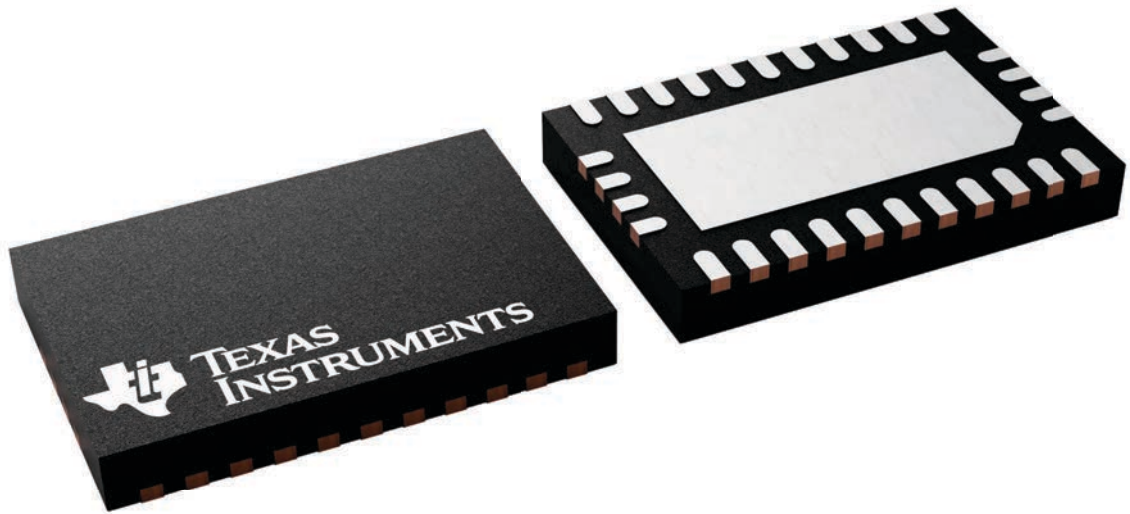

4225831/A

RNP0030B

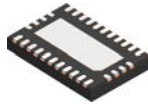

PACKAGE OUTLINE

WQFN - 0.8 mm max height

PLASTIC QUAD FLATPACK - NO LEAD

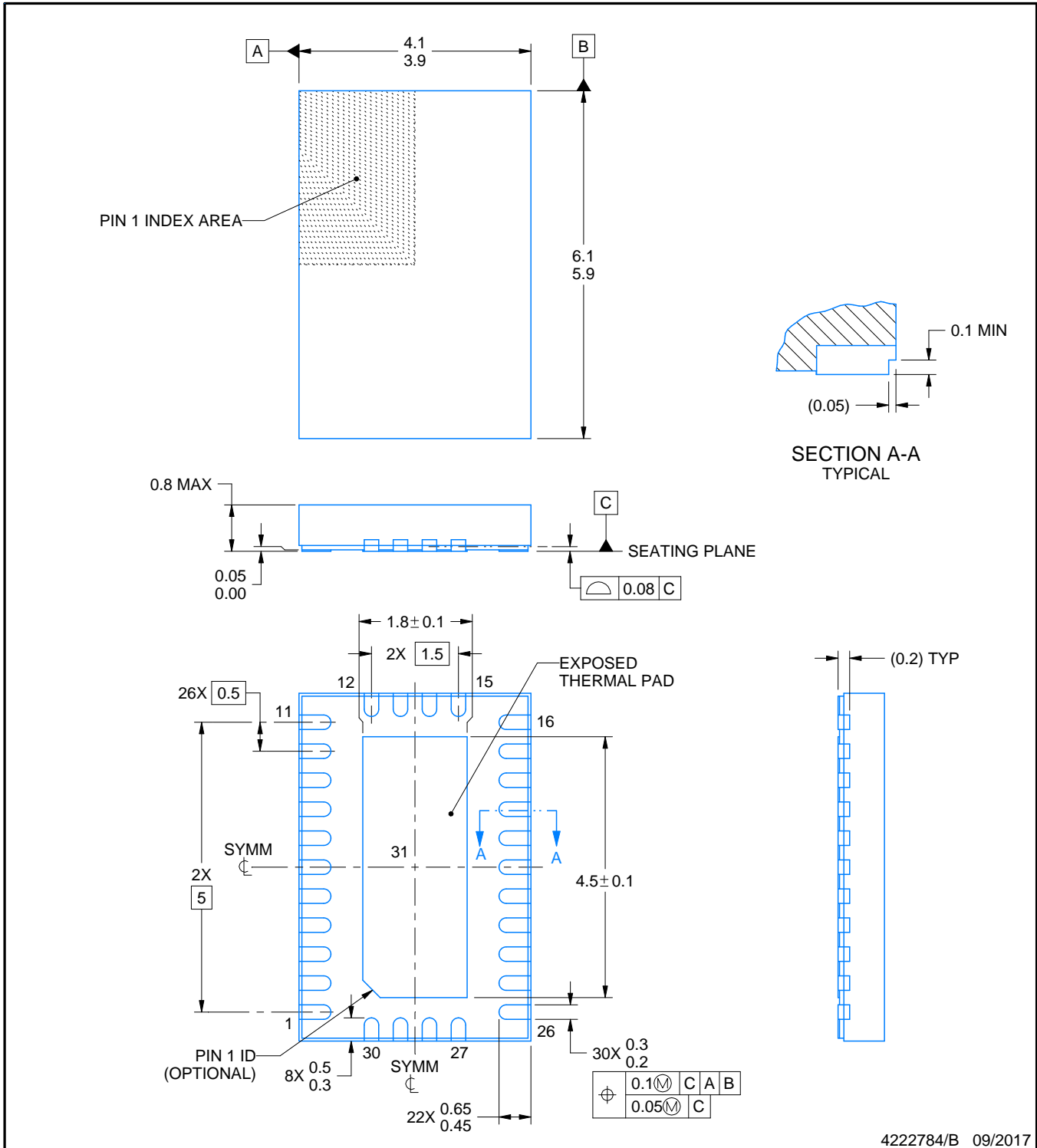

4222784/B 09/2017

NOTES:

1. All linear dimensions are in millimeters. Any dimensions in parenthesis are for reference only. Dimensioning and tolerancing per ASME Y14.5M.
2. This drawing is subject to change without notice.
3. The package thermal pad must be soldered to the printed circuit board for thermal and mechanical performance.

EXAMPLE BOARD LAYOUT

RNP0030B

WQFN - 0.8 mm max height

PLASTIC QUAD FLATPACK - NO LEAD

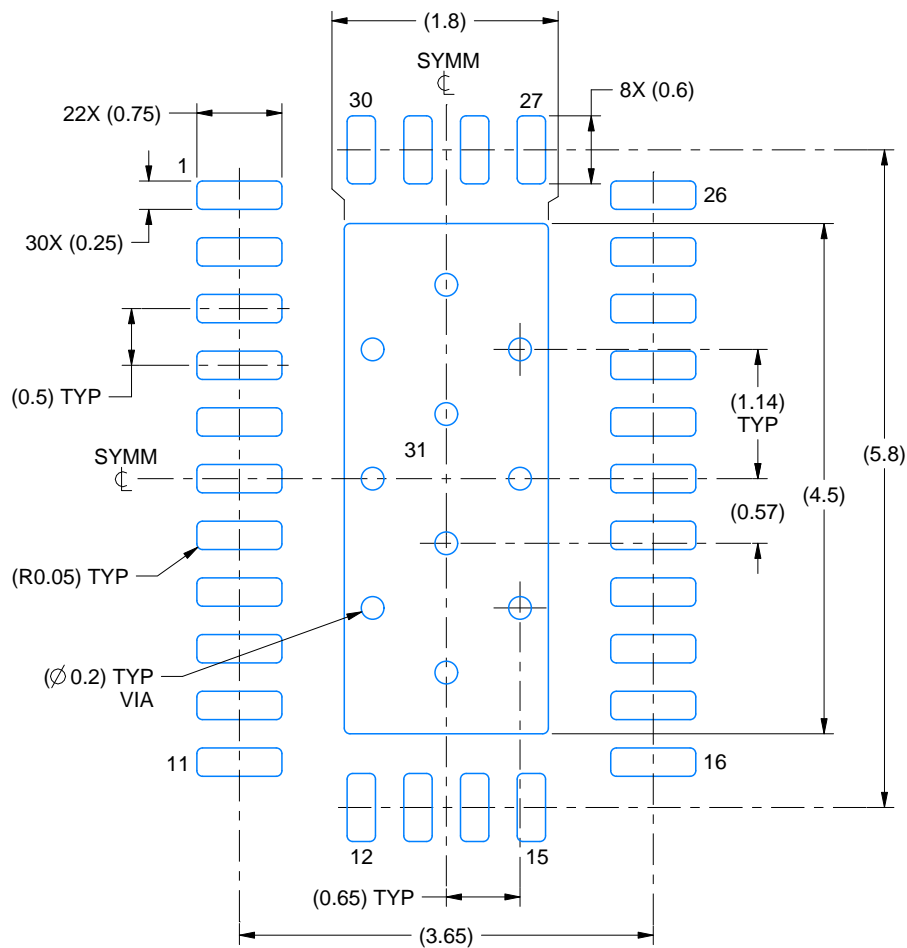

LAND PATTERN EXAMPLE
SCALE:15X

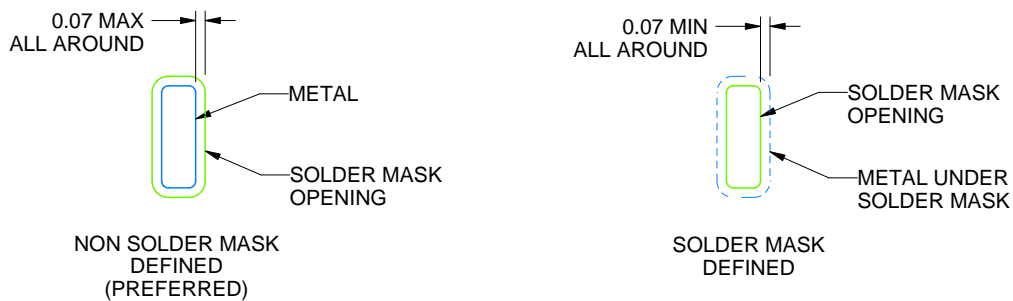

SOLDER MASK DETAILS

4222784/B 09/2017

NOTES: (continued)

4. This package is designed to be soldered to a thermal pad on the board. For more information, see Texas Instruments literature number SLUA271 (www.ti.com/lit/slua271).
5. Vias are optional depending on application, refer to device data sheet. If any vias are implemented, refer to their locations shown on this view. It is recommended that vias under paste be filled, plugged or tented.

EXAMPLE STENCIL DESIGN

RNP0030B

WQFN - 0.8 mm max height

PLASTIC QUAD FLATPACK - NO LEAD

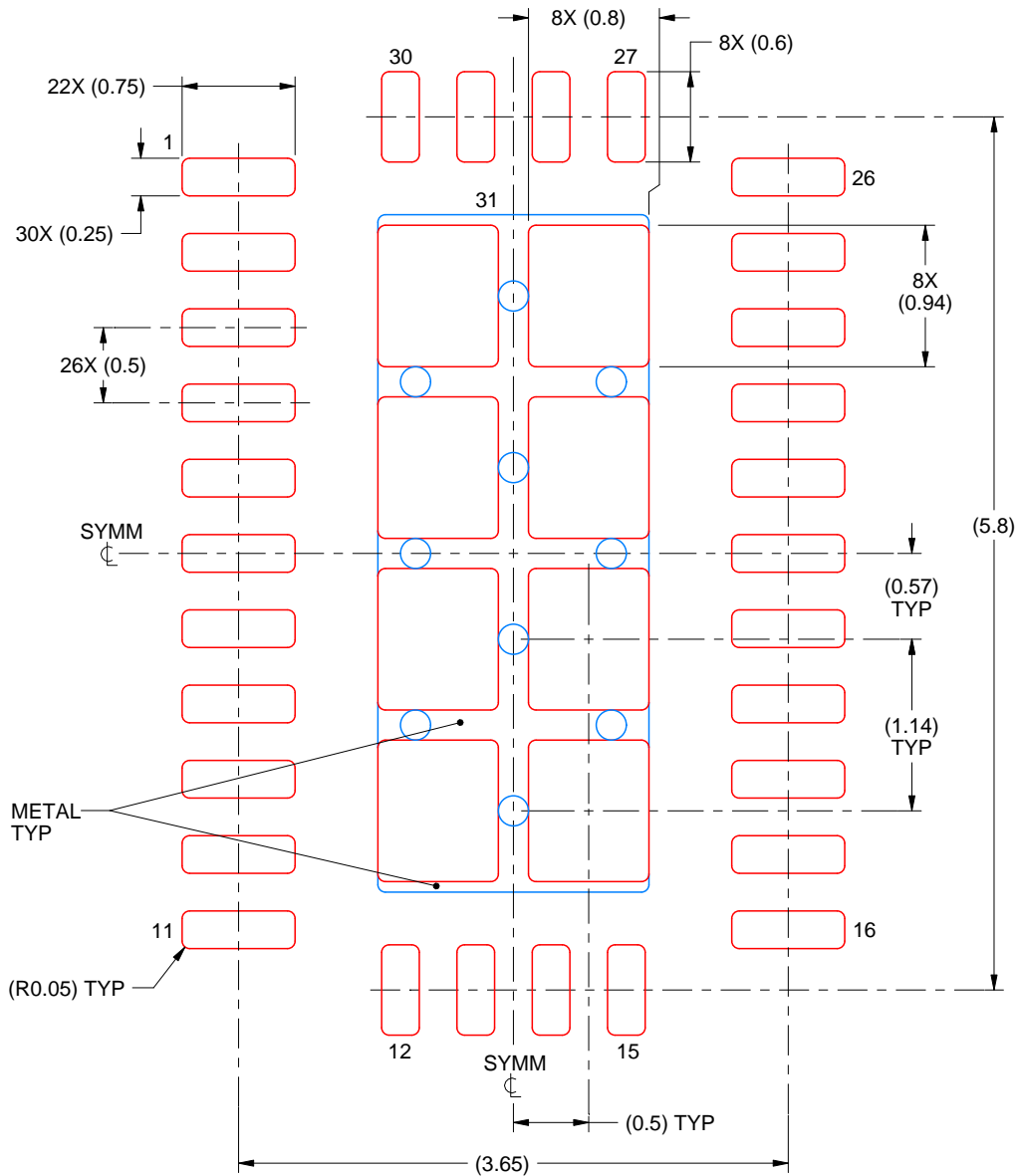

SOLDER PASTE EXAMPLE
 BASED ON 0.125 mm THICK STENCIL

EXPOSED PAD 31:
 74.3% PRINTED SOLDER COVERAGE BY AREA UNDER PACKAGE
 SCALE:20X

4222784/B 09/2017

NOTES: (continued)

6. Laser cutting apertures with trapezoidal walls and rounded corners may offer better paste release. IPC-7525 may have alternate design recommendations.

RNP0030E

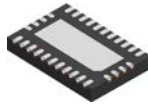

PACKAGE OUTLINE

WQFN - 0.8 mm max height

PLASTIC QUAD FLATPACK - NO LEAD

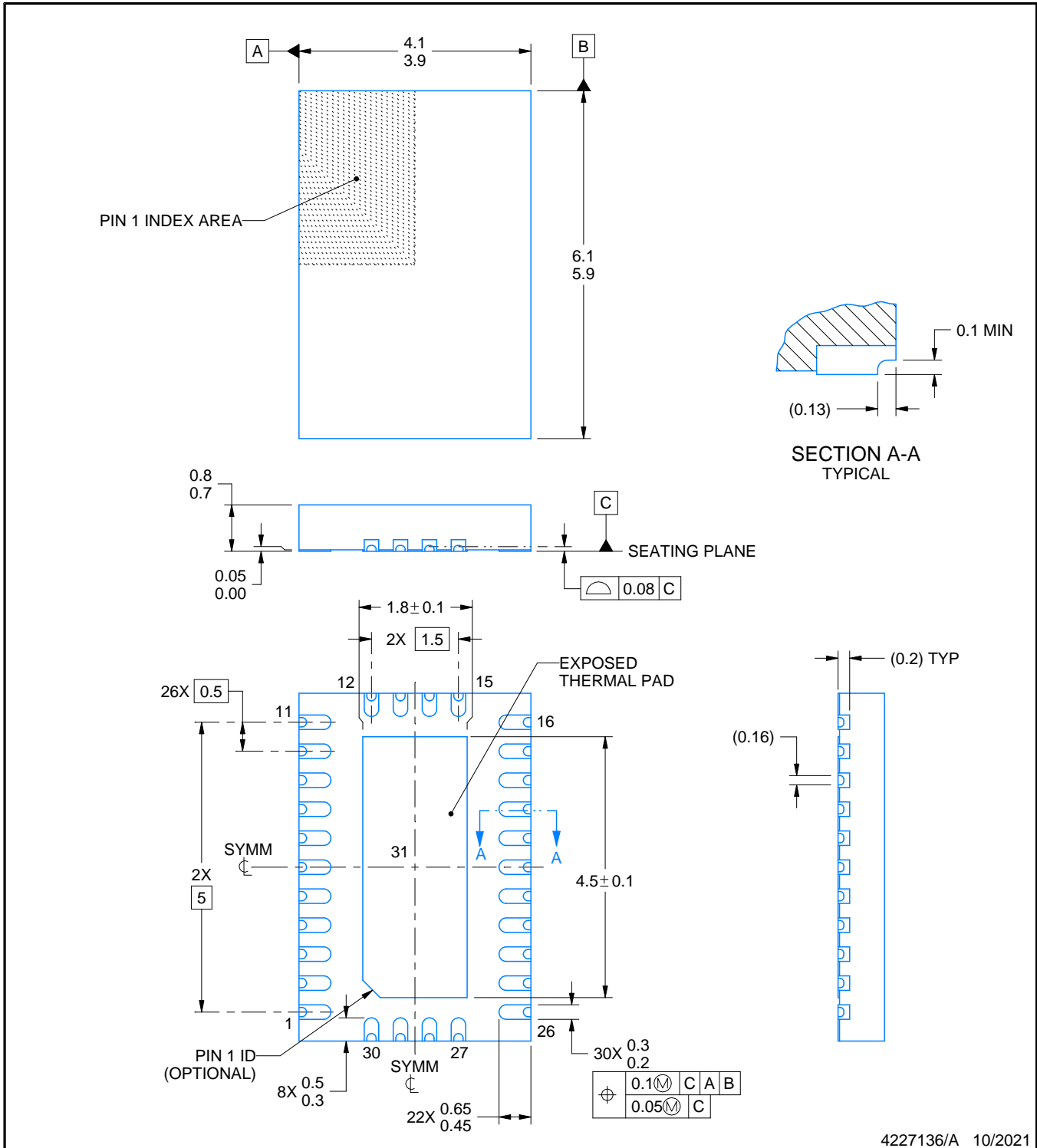

4227136/A 10/2021

NOTES:

1. All linear dimensions are in millimeters. Any dimensions in parenthesis are for reference only. Dimensioning and tolerancing per ASME Y14.5M.
2. This drawing is subject to change without notice.
3. The package thermal pad must be soldered to the printed circuit board for thermal and mechanical performance.

EXAMPLE BOARD LAYOUT

RNP0030E

WQFN - 0.8 mm max height

PLASTIC QUAD FLATPACK - NO LEAD

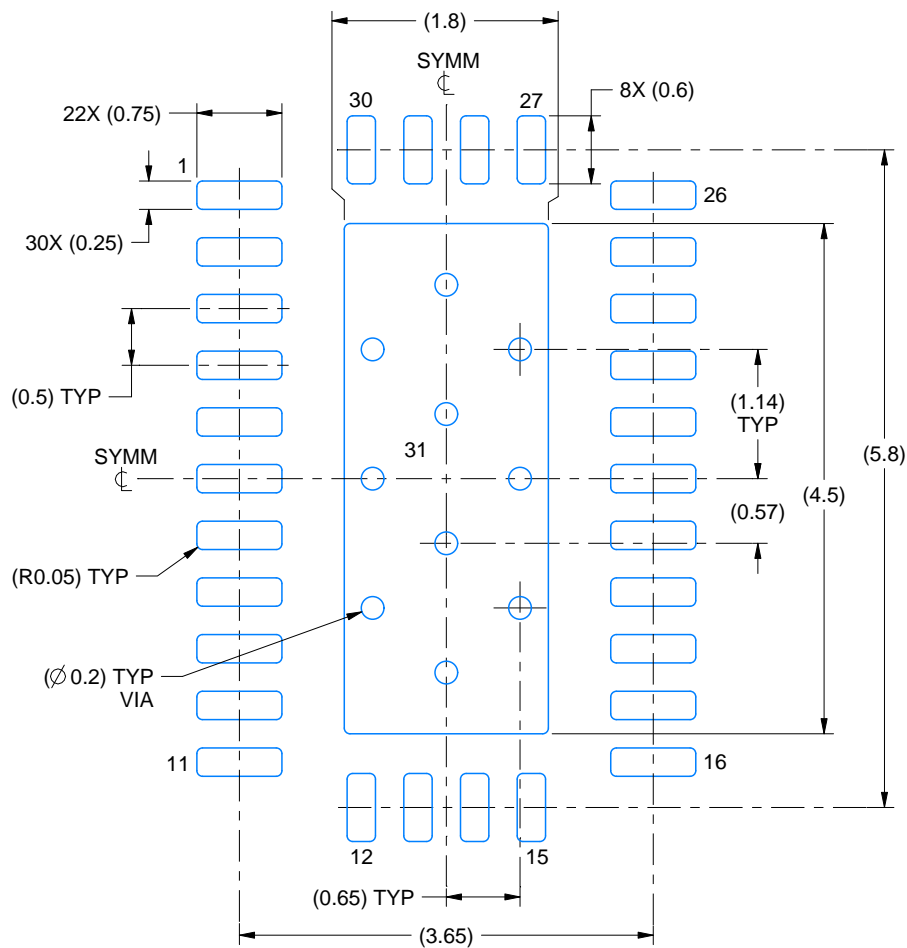

LAND PATTERN EXAMPLE
SCALE:15X

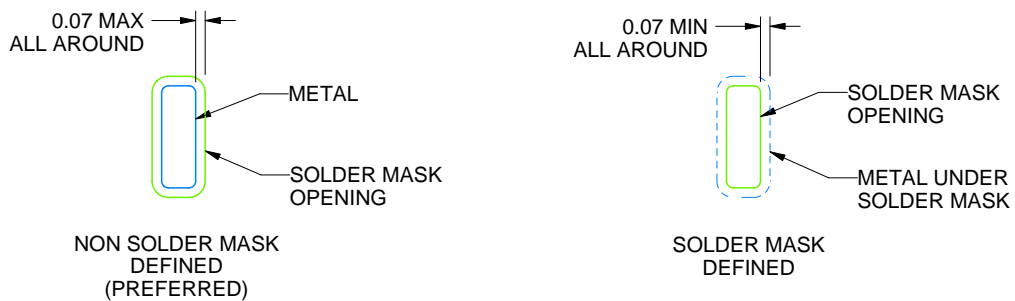

SOLDER MASK DETAILS

4227136/A 10/2021

NOTES: (continued)

4. This package is designed to be soldered to a thermal pad on the board. For more information, see Texas Instruments literature number SLUA271 (www.ti.com/lit/slua271).
5. Vias are optional depending on application, refer to device data sheet. If any vias are implemented, refer to their locations shown on this view. It is recommended that vias under paste be filled, plugged or tented.

EXAMPLE STENCIL DESIGN

RNP0030E

WQFN - 0.8 mm max height

PLASTIC QUAD FLATPACK - NO LEAD

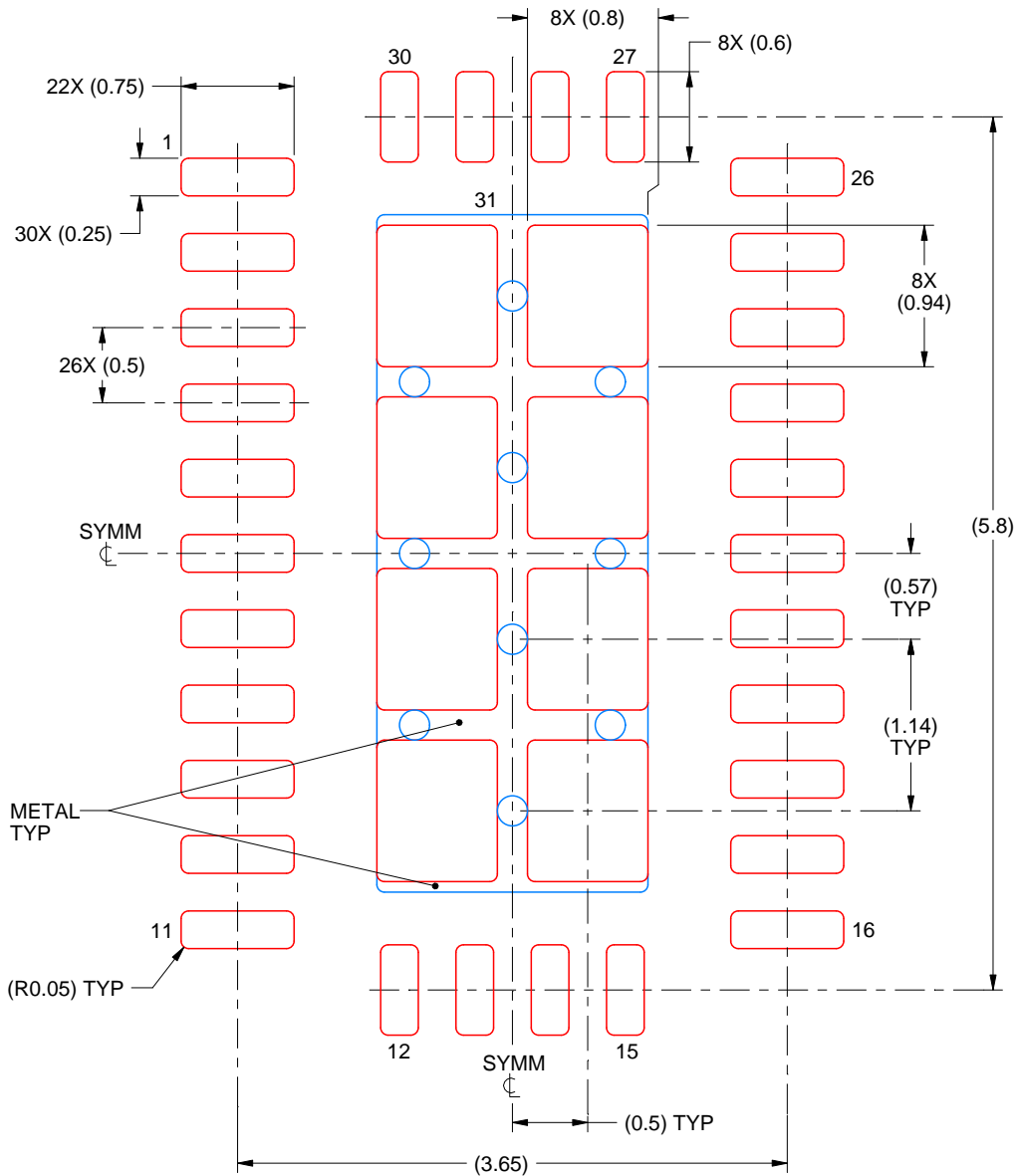

SOLDER PASTE EXAMPLE
 BASED ON 0.125 mm THICK STENCIL

EXPOSED PAD 31:
 74.3% PRINTED SOLDER COVERAGE BY AREA UNDER PACKAGE
 SCALE:20X

4227136/A 10/2021

NOTES: (continued)

6. Laser cutting apertures with trapezoidal walls and rounded corners may offer better paste release. IPC-7525 may have alternate design recommendations.

重要なお知らせと免責事項

TI は、技術データと信頼性データ (データシートを含みます)、設計リソース (リファレンス・デザインを含みます)、アプリケーションや設計に関する各種アドバイス、Web ツール、安全性情報、その他のリソースを、欠陥が存在する可能性のある「現状のまま」提供しており、商品性および特定目的に対する適合性の黙示保証、第三者の知的財産権の非侵害保証を含むいかなる保証も、明示的または黙示的にかかわらず拒否します。

これらのリソースは、TI 製品を使用する設計の経験を積んだ開発者への提供を意図したものです。(1) お客様のアプリケーションに適した TI 製品の選定、(2) お客様のアプリケーションの設計、検証、試験、(3) お客様のアプリケーションに該当する各種規格や、その他のあらゆる安全性、セキュリティ、規制、または他の要件への確実な適合に関する責任を、お客様のみが単独で負うものとし、

上記の各種リソースは、予告なく変更される可能性があります。これらのリソースは、リソースで説明されている TI 製品を使用するアプリケーションの開発の目的でのみ、TI はその使用をお客様に許諾します。これらのリソースに関して、他の目的で複製することや掲載することは禁止されています。TI や第三者の知的財産権のライセンスが付与されている訳ではありません。お客様は、これらのリソースを自身で使用した結果発生するあらゆる申し立て、損害、費用、損失、責任について、TI およびその代理人を完全に補償するものとし、TI は一切の責任を拒否します。

TI の製品は、[TI の販売条件](#)、または [ti.com](https://www.ti.com) やかかる TI 製品の関連資料などのいずれかを通じて提供する適用可能な条項の下で提供されています。TI がこれらのリソースを提供することは、適用される TI の保証または他の保証の放棄の拡大や変更を意味するものではありません。

お客様がいかなる追加条項または代替条項を提案した場合でも、TI はそれらに異議を唱え、拒否します。

郵送先住所 : Texas Instruments, Post Office Box 655303, Dallas, Texas 75265
Copyright © 2023, Texas Instruments Incorporated