

# UCC5871-Q1 30A 絶縁型 IGBT/SiC MOSFET ゲート・ドライバ、車載アプリケーション用先進保護機能付き

## 1 特長

- 分割出力ドライバは、30A のピーク・ソース (供給) 電流と 30A のピーク・シンク (吸い込み) 電流を実現
- 150ns (最大値) の伝搬遅延時間とプログラマブルな最小パルス除去を備えたインターロックおよび貫通電流保護機能
- 1 次側と 2 次側のアクティブ短絡 (ASC) をサポート
- 設定可能なパワー・トランジスタ保護機能
  - DESAT に基づく短絡保護機能
  - シャント抵抗を使った過電流および短絡保護機能
  - NTC による過熱保護
  - パワー・トランジスタ障害時のプログラマブル・ソフト・ターンオフ (STO) と 2 レベル・ターンオフ (2LTOFF)
- 機能安全準拠
  - 機能安全アプリケーション向けに開発
  - ASIL D までの ISO 26262 システム設計を支援するドキュメントを提供
- 診断機能内蔵:
  - 保護コンパレータのための内蔵セルフ・テスト (BIST)
  - IN+ からトランジスタのゲートへの経路の整合性
  - パワー・トランジスタのスレッシュホールドの監視
  - 内部クロックの監視
  - フォルト・アラーム (nFLT1) および警告 (nFLT2) 出力
- 内蔵の 4A アクティブ・ミラー・クランプまたは外付けのミラー・クランプ・トランジスタ用外部駆動 (任意)
- 先進の高電圧クランプ制御
- 内部および外部電源の低電圧および過電圧保護
- 低電源またはフローティング入力時の、アクティブ出力プルダウンおよびデフォルト Low 出力
- ドライバ・ダイ温度センシングおよび過熱保護機能
- $V_{CM} = 1000V$  で  $100kV/\mu s$  以上のコモン・モード過渡耐性 (CMTI)
- SPI ベースのデバイス再構成、検証、監視、診断機能
- 内蔵 10 ビット ADC によるパワー・トランジスタ温度、電圧、電流の監視

## 2 アプリケーション

- HEV および EV トラクション・インバータ
- HEV および EV 電源モジュール

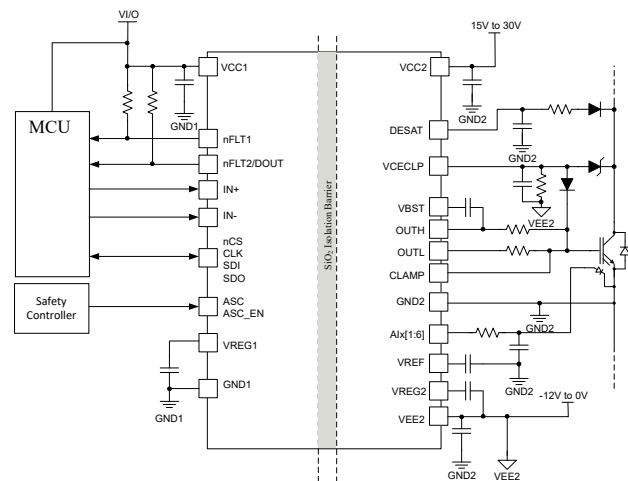
## 3 概要

UCC5871-Q1 デバイスは、EV/HEV アプリケーションの大電力 SiC MOSFET および IGBT を駆動するための高度に構成可能な絶縁型シングル・チャンネル・ゲート・ドライバです。シャント抵抗を使った過電流保護、NTC を使った過熱保護、DESAT 検出などのパワー・トランジスタ保護機能には、これらのフォルト中の選択可能なソフト・ターンオフまたは 2 レベルのターンオフが含まれます。アプリケーションのサイズをさらに小さくするため、UCC5871-Q1 は、スイッチング中の 4A アクティブ・ミラー・クランプとドライバに電力が供給されていない間のアクティブ・ゲート・プルダウンを内蔵しています。内蔵の 10 ビット ADC を使うと、最大 6 つのアナログ入力とゲート・ドライバ温度を監視することでシステム管理を強化できます。システム設計を簡素化する診断および検出機能を内蔵しています。これらの機能のパラメータとスレッシュホールドは SPI インターフェイスを使って設定できるため、本デバイスはほとんどすべての SiC MOSFET または IGBT と組み合わせ使用できます。

### 製品情報

部品番号 (1)	パッケージ	本体サイズ (公称)
UCC5871-Q1	SSOP (36)	12.8mm × 7.5mm

- (1) 利用可能なパッケージについては、このデータシートの末尾にある注文情報を参照してください。



概略回路図



## Table of Contents

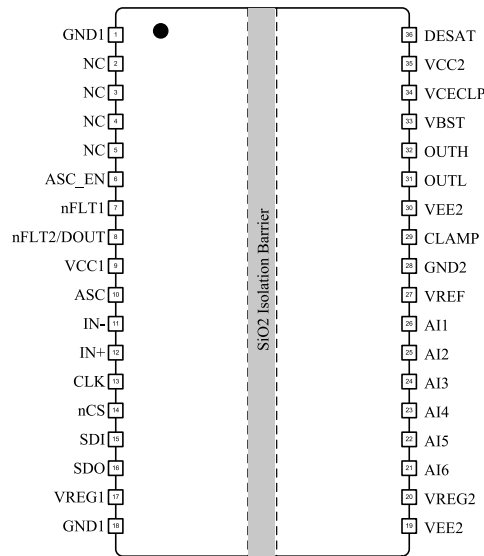
<b>1 特長</b> .....	1	6.10 Switching Characteristics.....	16
<b>2 アプリケーション</b> .....	1	6.11 Typical Characteristics.....	18
<b>3 概要</b> .....	1	<b>7 Layout</b> .....	22
<b>4 Revision History</b> .....	2	7.1 Layout Guidelines.....	22
<b>5 Pin Configuration and Functions</b> .....	3	7.2 Layout Example.....	23
<b>6 Specifications</b> .....	6	<b>8 Device and Documentation Support</b> .....	24
6.1 Absolute Maximum Ratings.....	6	8.1 Device Support.....	24
6.2 ESD Ratings.....	6	8.2 Documentation Support.....	24
6.3 Recommended Operating Conditions.....	6	8.3 Receiving Notification of Documentation Updates....	24
6.4 Thermal Information.....	7	8.4 サポート・リソース.....	24
6.5 Power Ratings.....	7	8.5 Trademarks.....	24
6.6 Insulation Specifications.....	7	8.6 Electrostatic Discharge Caution.....	24
6.7 Safety Limiting Values.....	8	8.7 Glossary.....	24
6.8 Electrical Characteristics.....	9	<b>9 Mechanical, Packaging, and Orderable Information..</b>	<b>24</b>
6.9 SPI Timing Requirements.....	16		

## 4 Revision History

資料番号末尾の英字は改訂を表しています。その改訂履歴は英語版に準じています。

DATE	REVISION	NOTES
December 2022	*	Initial Release

## 5 Pin Configuration and Functions



**图 5-1. DWJ 36-Pin SOIC Top View**

**表 5-1. Pin Functions**

PIN		I/O <sup>(1)</sup>	DESCRIPTION
NO.	NAME		
1	GND1	G	Primary Side Ground. Connect all GND1 pins together and to the PCB ground plane on the primary side.
2	NC	—	No internal connection. Connect to GND1.
3	NC	—	No internal connection. Connect to GND1.
4	NC	—	No internal connection. Connect to GND1.
5	NC	—	No internal connection. Connect to GND1.
6	ASC_EN	I	Active Short Circuit Enable Input. ASC_EN enables the ASC function and forces the output of the driver to the state defined by the ASC input. If ASC is high, OUTH is pulled high. If ASC is low, OUTL is pulled low.
7	nFLT1	O	Fault Indicator Output 1. nFLT1 is used to interrupt the host when a fault occurs. Faults that are unmasked pull nFLT1 low when the fault occurs. nFLT1 is high when all faults are either non-existent or masked.
8	nFLT2/DOOUT	O	Fault Indicator Output 2. nFLT2 is used to interrupt the host when a fault occurs. Additionally, nFLT2 may be configured as DOOUT to provide the host controller a PWM signal with a duty cycle relative to the ADC input of interest. Faults that are unmasked pull nFLT2 low when the fault occurs. nFLT2 is high when all faults are either non-existent or masked.
9	V <sub>CC1</sub>	P	Primary Side Power Supply. Connect a 3V to 5.5V power supply to VCC1. Bypass VCC1 to GND1 with ceramic bulk capacitance as close to the VCC1 pin as possible.
10	ASC	I	Active Short Circuit Control Input. ASC sets the drive state when ASC_EN is high. If ASC is high, OUTH is pulled high. If ASC is low, OUTL is pulled low.
11	IN-	I	Negative PWM Input. IN- is connected to the IN+ from the opposite arm of the half-bridge. If IN+ and IN- overlap, the Shoot Through Protection (STP) fault is asserted.
12	IN+	I	Positive PWM Input. IN+ drives the state of the driver output. With the driver enabled, when IN+ is high, OUTH is pulled high. When IN+ is low, OUTL is pulled low. Drive IN+ with a 1kHz to 50kHz PWM signal, with a logic level determined by the VCC1 voltage. IN+ is connected to the IN- of the opposite arm of the half-bridge. If IN+ and IN- overlap, the Shoot Through Protection (STP) fault is asserted.
13	CLK	I	SPI Clock. CLK is the clock signal for the main SPI interface. The SPI interface operates with clock rates up to 4MHz.
14	nCS	I	SPI Chip Selection Input. nCS is an active low input used to activate the SPI peripheral device. Drive nCS low during SPI communication. When nCS is high, the CLK and SDI inputs are ignored.
15	SDI	I	SPI Data Input. SDI is the data input for the main SPI interface. Data is sampled on the falling edge of CLK, SDI must be in a stable condition to ensure proper communication.

表 5-1. Pin Functions (continued)

PIN		I/O <sup>(1)</sup>	DESCRIPTION
NO.	NAME		
16	SDO	O	SPI Data Output. SDO is the data output for the main SPI interface. Data is clocked out on the falling edge of CLK, SDO is changed with a rising edge of CLK.
17	V <sub>REG1</sub>	P	Internal Voltage Regulator Output. VREG1 provides a 1.8V rail for internal primary-side circuits. Bypass VREG1 to GND1 with at least 4.7µF of ceramic capacitance. Do not put any additional load on VREG1.
18	GND1	G	Primary Side Ground. Connect all GND1 pins together and to the PCB ground plane on the primary side.
19	V <sub>EE2</sub>	P	Secondary Negative Power Supply. Connect all VEE2 supply inputs together. Connect a -12V to 0V power supply to VEE2. The total voltage rail from VCC2 to VEE2 must not exceed 30V. Bypass VEE2 to GND2 with at least 1µF of ceramic capacitance as close to the VEE1 pin as possible.
20	V <sub>REG2</sub>	P	Internal voltage regulator output. VREG2 provides a 1.8V rail for internal secondary-side circuits. Bypass VREG2 to VEE2 with at least 4.7µF of ceramic capacitance. Do not put any additional load on VREG2.
21	AI6	I	Analog Input 6. AI6 is a multi-function input. It is configurable as an input to the internal ADC, a power FET current sense protection comparator input, and an ASC input for the secondary side.
22	AI5	I	Analog Input 5. AI5 is a multi-function input. It is configurable as an input to the internal ADC, a power FET over temperature protection comparator input, and an ASC_EN input for the secondary side.
23	AI4	I	Analog Input 4. AI4 is a multi-function input. It is configurable as an input to the internal ADC and a power FET current sense protection comparator input.
24	AI3	I	Analog Input 3. AI3 is a multi-function input. It is configurable as an input to the internal ADC and a power FET current sense protection comparator input.
25	AI2	I	Analog Input 2. AI2 is a multi-function input. It is configurable as an input to the internal ADC and a power FET current sense protection comparator input.
26	AI1	I	Analog Input 1. AI1 is a multi-function input. It is configurable as an input to the internal ADC and a power FET current sense protection comparator input.
27	V <sub>REF</sub>	P	Internal ADC Voltage Regulator Output. VREF provides an internal 4V, reference for the ADC. Bypass VREF to GND2 with at least 1µF of ceramic capacitance. If an external reference is desired, disable the internal VREF using the SPI register, and connect a 4V reference supply to VREF. Loads up to 5mA on VREF are allowed.
28	GND2	G	Gate Drive Common Input. Connect GND2 to the power FET source/ IGBT emitter. All AIx inputs, VREF, and DESAT are referenced to GND2.
29	CLAMP	IO	Miller Clamp Input. The CLAMP input is used to hold the gate of the power FET strongly to VEE2 while the power FET is "off". CLAMP is configurable as an internal Miller clamp, or to drive an external clamping circuit. When using the internal clamping function, connect CLAMP directly to the power FET gate. When configured as an external clamp, connect CLAMP to the gate of an external pulldown MOSFET.
30	V <sub>EE2</sub>	P	Secondary negative power supply. Connect all VEE2 supply inputs together. Connect a -12V to 0V power supply to VEE2. The total voltage rail from VCC2 to VEE2 must not exceed 30V. Bypass VEE2 to GND2 with at least 1µF of ceramic capacitance as close to the VEE2 pin as possible. Additional capacitance may be needed depending on the required drive current.
31	OUTL	O	Negative Gate Drive Voltage Output. When the driver is active, OUTL drives the gate of the power FET low when INP is low. Connect OUTL to the gate of the power FET through a gate resistor. The value of the gate resistor is chosen based on the slew rate required for the application.
32	OUTH	O	Positive Gate Drive Voltage Output. When the driver is active, OUTH drives the gate of the power FET high when INP is high. Connect OUTH to the gate of the power FET through a gate resistor. The value of the gate resistor is chosen based on the slew rate required for the application.
33	V <sub>BST</sub>	P	Bootstrap Supply. VBST supplies power for the OUTH drive. Connect a 0.1µF ceramic capacitor between VBST and OUTH.
34	V <sub>CECLP</sub>	I	VCE Clamp Input. VCECLP clamps to a diode above the VCC2 rail and indicates a fault when the voltage at VCECLP is above the VCECLPth threshold. Bypass VCECLP to VEE2 with ceramic capacitor and, in parallel, connect a resistor. Additionally, connect VCECLP to the anode of a zener diode to the collector of the power FET.
35	V <sub>CC2</sub>	P	Secondary Positive Power Supply. Connect a 15V to 30V power supply to VCC2. The total voltage rail from VCC2 to VEE2 must not exceed 30V. Bypass VCC2 to GND2 and VCC2 to VEE2 with bulk ceramic capacitance as close to the VCC2 pin as possible. Additional capacitance may be needed depending on the required drive current.

**表 5-1. Pin Functions (continued)**

PIN		I/O <sup>(1)</sup>	DESCRIPTION
NO.	NAME		
36	DESAT	I	Desaturation based Short Circuit Detection Input. DESAT is used to detect a short circuit in the power FET. Bypass DESAT to GND2 with a ceramic capacitor to program the DESAT blanking time. In parallel, connect a schottky diode with the cathode connected to the DESAT. Additionally, connect DESAT to a resistor to the anode of a diode to the collector of the power FET to adjust the DESAT protection threshold. DESAT detects a fault when the VCE voltage of the power FET exceeds the defined threshold while the power FET is on.

(1) P = Power, G = Ground, I = Input, O = Output, - = NA

## 6 Specifications

### 6.1 Absolute Maximum Ratings

over operating free-air temperature range (unless otherwise noted)<sup>(1)</sup>

		MIN	MAX	UNIT
V <sub>CC1</sub>	Supply voltage primary side referenced to GND1	-0.3	6	V
V <sub>CC2</sub>	Positive supply voltage secondary side referenced to GND2	-0.3	33	V
V <sub>EE2</sub>	Negative supply voltage output side referenced to GND2	-15	0.3	V
V <sub>SUP2</sub>	Total supply voltage output side (V <sub>CC2</sub> - V <sub>EE2</sub> )	-0.3	33	V
V <sub>OUTH</sub> , V <sub>OUTL</sub>	Voltage on the driver output pins referenced to GND2	V <sub>EE2</sub> -0.3	V <sub>CC2</sub> +0.3	V
V <sub>IOP</sub>	Voltage on IO pins (ASC, ASC_EN, CLK, IN+, IN-, nCS, nFLTx, SDI, SDO) on primary side referenced to GND1	-0.3	V <sub>CC1</sub> +0.3	V
V <sub>CLAMP</sub>	Voltage on the Miller clamp pin referenced to GND2	V <sub>EE2</sub> -0.3	V <sub>CC2</sub> +0.3	V
V <sub>DESAT</sub>	Voltage on DESAT referenced to GND2	-0.3	V <sub>CC2</sub> +0.3	V
V <sub>CECLP</sub>	Voltage on VCECLP referenced to GND2	V <sub>EE2</sub> -0.3	V <sub>CC2</sub> +0.3	V
V <sub>REG1</sub>	Voltage on VREG1 referenced to GND1	-0.3	2	V
V <sub>REG2</sub>	Voltage on VREG2 referenced to VEE2	-0.3	2	V
V <sub>REF</sub>	Voltage on VREF referenced to GND2	-0.3	5.5	V
V <sub>BST</sub>	Voltage on VBST referenced to OUTH	-0.3	5.3	V
V <sub>AI</sub>	Voltage on the analog inputs referenced to GND2	-0.3	5.5	V
T <sub>J</sub>	Junction temperature	-40	150	°C
T <sub>stg</sub>	Storage temperature	-65	150	°C

- (1) Stresses beyond those listed under *Absolute Maximum Ratings* may cause permanent damage to the device. These are stress ratings only, which do not imply functional operation of the device at these or any other conditions beyond those indicated under *Recommended Operating Conditions*. Exposure to absolute-maximum-rated conditions for extended periods may affect device reliability.

### 6.2 ESD Ratings

			VALUE	UNIT	
V <sub>(ESD)</sub>	Electrostatic discharge	Human body model (HBM), per AEC Q100-002 <sup>(1)</sup>	±2000	V	
		Charged device model (CDM), per AEC Q100-011	Corner pins (GND1 and VEE2)		±750
			Other pins		±500

- (1) AEC Q100-002 indicates that HBM stressing shall be in accordance with the ANSI/ESDA/JEDEC JS-001 specification.

### 6.3 Recommended Operating Conditions

over operating free-air temperature range (unless otherwise noted)

		MIN	NOM	MAX	UNIT
V <sub>CC1</sub>	Supply voltage input side	3		5.5	V
V <sub>CC2</sub>	Positive supply voltage secondary side (V <sub>CC2</sub> - GND2)	15		30	V
V <sub>EE2</sub>	Negative supply voltage output side (V <sub>EE2</sub> - GND2)	-12		0	V
V <sub>SUP2</sub>	Total supply voltage output side (V <sub>CC2</sub> - V <sub>EE2</sub> )	15		30	V
V <sub>IH</sub>	High-level IO voltage (ASC, ASC_EN, IN+, IN-, nCS, SCLK, SDI)	0.7*V <sub>CC1</sub>		V <sub>CC1</sub>	V
V <sub>IL</sub>	Low-level IO voltage (ASC, ASC_EN, IN+, IN-, nCS, SCLK, SDI)	0		0.3*V <sub>CC1</sub>	V
I <sub>OHP</sub>	Source current for primary side outputs (nFLT2, SDO)			5	mA
I <sub>OLP</sub>	Sink current for primary side outputs (nFLTx, SDO)			5	mA
I <sub>OH</sub>	Driver output source current from OUTH <sup>(1)</sup>			15	A
I <sub>OL</sub>	Driver output sink current into OUTL <sup>(1)</sup>			15	A
V <sub>AI*</sub>	Voltage on analog input (AI) pins referenced to GND2	0		V <sub>REF</sub> +0.1	V

### 6.3 Recommended Operating Conditions (continued)

over operating free-air temperature range (unless otherwise noted)

		MIN	NOM	MAX	UNIT
V <sub>VREG1</sub>	Output voltage at VREG1 referenced to GND1 <sup>(2)</sup>		1.8		V
V <sub>VREG2</sub>	Output voltage at VREG2 referenced to VEE2 <sup>(3)</sup>		1.8		V
V <sub>VBST</sub>	Output voltage at VBST referenced to OUTH <sup>(4)</sup>		V <sub>cc2</sub> + 4.5		V
V <sub>VREF</sub>	Voltage on the VREF pin vs GND2 <sup>(5)</sup>	0	4	4.1	V
CMTI	Common mode transient immunity rating (dV/dt rate across the isolation barrier)			100	kV/us
f <sub>PWM</sub>	PWM input frequency (IN+ and IN- pins)			50	kHz
f <sub>SPI</sub>	SPI clock frequency			4	MHz
T <sub>J</sub>	Maximum junction temperature	- 40		150	°C
t <sub>PWM</sub>	PWM input pulse width (IN+ and IN- pins)	250			ns

- (1) External gate resistor needs to be used to limit the max drive current to be not more than 15A.
- (2) Connect a decoupling capacitor of 0.1uF+4.7uF between VREG1 and GND1. Do not connect external supply.
- (3) Connect a decoupling capacitor of 0.1uF+4.7uF between VREG2 and VEE2. Do not connect external supply.
- (4) Connect a decoupling capacitor of 100nF between VBST and OUTH. Do not connect external supply.
- (5) Connect a decoupling capacitor of 1.0uF on the VREF pin.

### 6.4 Thermal Information

THERMAL METRIC <sup>(1)</sup>		UCC5870/UCC5871		UNIT
		DWJ		
		36 SOIC		
R <sub>θJA</sub>	Junction-to-ambient thermal resistance	50.6		°C/W
R <sub>θJC(top)</sub>	Junction-to-case (top) thermal resistance	17.5		°C/W
R <sub>θJB</sub>	Junction-to-board thermal resistance	21.3		°C/W
Ψ <sub>JT</sub>	Junction-to-top characterization parameter	5.3		°C/W
Ψ <sub>JB</sub>	Junction-to-board characterization parameter	20.2		°C/W
R <sub>θJC(bot)</sub>	Junction-to-case (bottom) thermal resistance	N/A		°C/W

- (1) For more information about traditional and new thermal metrics, see the [Semiconductor and IC Package Thermal Metrics](#) application report.

### 6.5 Power Ratings

PARAMETER		TEST CONDITIONS	MIN	TYP	MAX	UNIT
P <sub>D</sub>	Maximum power dissipation (both sides)	T <sub>A</sub> = 125C			500	mW
P <sub>D1</sub>	Maximum power dissipation (side-1)	T <sub>A</sub> = 125C			50	mW
P <sub>D2</sub>	Maximum power dissipation (side-2)	T <sub>A</sub> = 125C			450	mW

### 6.6 Insulation Specifications

PARAMETER		TEST CONDITIONS	SPECIFIC ATION	UNIT
<b>PACKAGE SPECIFICATIONS</b>				
CLR	External clearance <sup>(1)</sup>	Shortest terminal-to-terminal distance through air	8	mm
CPG	External creepage <sup>(1)</sup>	Shortest terminal-to-terminal distance across the package surface	8	mm
DTI	Distance through the insulation	Minimum internal gap (internal clearance)	> 17	μm
CTI	Comparative tracking index	DIN EN 60112 (VDE 0303-11); IEC 60112	600	V
	Material group	According to IEC60664-1	I	

## 6.6 Insulation Specifications (continued)

PARAMETER		TEST CONDITIONS	SPECIFIC ATION	UNIT
	Overvoltage category	Rated mains voltage $\leq 600 V_{RMS}$	I-IV	
		Rated mains voltage $\leq 1000 V_{RMS}$	I-III	
<b>Test 1</b>				
$V_{IORM}$	Maximum repetitive peak isolation voltage	AC voltage (bipolar)	2121	$V_{PK}$
$V_{IOWM}$	Maximum isolation working voltage	AC voltage (sine wave); time-dependent dielectric breakdown (TDDB) test	1500	$V_{RMS}$
		DC voltage	2121	$V_{DC}$
$V_{IOTM}$	Maximum transient isolation voltage	$V_{TEST} = V_{IOTM}$ , $t=60s$ (qualification); $V_{TEST} = 1.2 \times V_{IOTM}$ , $t=1s$ (100% production)	8000	$V_{PK}$
$V_{IOSM}$	Maximum surge isolation voltage	Test method per IEC 62368-1, 1.2/50 $\mu s$ waveform, $V_{TEST} = 1.6 \times V_{IOSM}$	8000	$V_{PK}$
$q_{pd}$	Apparent charge	Method a: After I/O safety test subgroup 2/3, $V_{ini} = V_{IOTM}$ , $t_{ini} = 60 s$ ; $V_{pd(m)} = 1.2 \times V_{IORM}$ , $t_m = 10 s$	$\leq 5$	pC
		Method a: After environmental tests subgroup 1, $V_{ini} = V_{IOTM}$ , $t_{ini} = 60 s$ ; $V_{pd(m)} = 1.6 \times V_{IORM}$ , $t_m = 10 s$	$\leq 5$	
		Method b1: At routine test (100% production) and preconditioning (type test), $V_{ini} = 1.2 \times V_{IOTM}$ , $t_{ini} = 1 s$ ; $V_{pd(m)} = 1.875 \times V_{IORM}$ , $t_m = 1 s$	$\leq 5$	
<b>Test 2</b>				
$C_{IO}$	Barrier capacitance, input to output <sup>(2)</sup>	$V_{IO} = 0.4 \times \sin(2\pi ft)$ , $f = 1 MHz$	2	pF
$R_{IO}$	Insulation resistance, input to output <sup>(2)</sup>	$V_{IO} = 500 V$ , $T_A = 25^\circ C$	$10^{12}$	$\Omega$
		$V_{IO} = 500 V$ , $100^\circ C \leq T_A \leq 125^\circ C$	$10^{11}$	
		$V_{IO} = 500 V$ at $T_S = 150^\circ C$	$10^9$	
$V_{ISO}$	Withstand isolation voltage	$V_{TEST} = V_{ISO} = V_{RMS}$ , $t = 60 s$ (qualification), $V_{TEST} = 1.2 \times V_{ISO} = V_{RMS}$ , $t = 1 s$ (100% production)		$V_{RMS}$

- (1) Creepage and clearance requirements should be applied according to the specific equipment isolation standards of an application. Care should be taken to maintain the creepage and clearance distance of a board design to ensure that the mounting pads of the isolator on the printed-circuit board do not reduce this distance. Creepage and clearance on a printed-circuit board become equal in certain cases. Techniques such as inserting grooves, ribs, or both on a printed-circuit board are used to help increase these specifications.
- (2) All pins on each side of the barrier tied together creating a two-pin device.

## 6.7 Safety Limiting Values

Safety limiting<sup>(1)</sup> intends to minimize potential damage to the isolation barrier upon failure of input or output circuitry.

PARAMETER	TEST CONDITIONS	MIN	TYP	MAX	UNIT
<b>36-DWJ PACKAGE</b>					
$I_S$	Safety output supply current	$R_{\theta JA} = 50.6^\circ C/W$ , $V_{VCC2} = 15V$ , $T_J = 150^\circ C$ , $T_A = 25^\circ C$		164	mA
		$R_{\theta JA} = 50.6^\circ C/W$ , $V_{VCC2} = 30V$ , $T_J = 150^\circ C$ , $T_A = 25^\circ C$		82	
$P_S$	Safety input power			83	mW
$P_S$	Safety output power			2460	mW
$P_S$	Safety total power			2543	mW



Safety limiting<sup>(1)</sup> intends to minimize potential damage to the isolation barrier upon failure of input or output circuitry.

PARAMETER		TEST CONDITIONS	MIN	TYP	MAX	UNIT
T <sub>S</sub>	Maximum safety temperature				150	°C

- (1) The maximum safety temperature, T<sub>S</sub>, has the same value as the maximum junction temperature, T<sub>J</sub>, specified for the device. The I<sub>S</sub> and P<sub>S</sub> parameters represent the safety current and safety power respectively. The maximum limits of I<sub>S</sub> and P<sub>S</sub> should not be exceeded. These limits vary with the ambient temperature, T<sub>A</sub>. The junction-to-air thermal resistance, R<sub>θJA</sub>, in the table is that of a device installed on a high-K test board for leaded surface-mount packages. Use these equations to calculate the value for each parameter: T<sub>J</sub> = T<sub>A</sub> + R<sub>θJA</sub> × P, where P is the power dissipated in the device. T<sub>J(max)</sub> = T<sub>S</sub> = T<sub>A</sub> + R<sub>θJA</sub> × P<sub>S</sub>, where T<sub>J(max)</sub> is the maximum allowed junction temperature. P<sub>S</sub> = I<sub>S</sub> × V<sub>I</sub>, where V<sub>I</sub> is the maximum input voltage.

## 6.8 Electrical Characteristics

Over recommended operating conditions unless otherwise noted.

PARAMETER		TEST CONDITIONS	MIN	TYP	MAX	UNIT
<b>POWER SUPPLY</b>						
V <sub>IT+</sub> (UVLO1)	UVLO threshold of V <sub>CC1</sub> rising	UVOV1_LEVEL = 0	2.6	2.75	2.9	V
V <sub>IT+</sub> (UVLO1)	UVLO threshold of V <sub>CC1</sub> rising	UVOV1_LEVEL = 1	4.5	4.65	4.8	V
V <sub>IT-</sub> (UVLO1)	UVLO threshold of V <sub>CC1</sub> falling	UVOV1_LEVEL = 0	2.3	2.45	2.6	V
V <sub>IT-</sub> (UVLO1)	UVLO threshold of V <sub>CC1</sub> falling	UVOV1_LEVEL = 1	4.2	4.35	4.5	V
V <sub>HYS</sub> (UVLO1)	UVLO threshold hysteresis of V <sub>CC1</sub>			0.30		V
t <sub>UVLO1</sub>	VCC1 UVLO detection deglitch time			20		μs
V <sub>IT-</sub> (OVLO1)	OVLO threshold of V <sub>CC1</sub> falling	UVOV1_LEVEL = 0	3.7	3.85	4.0	V
V <sub>IT-</sub> (OVLO1)	OVLO threshold of V <sub>CC1</sub> falling	UVOV1_LEVEL = 1	5.2	5.35	5.5	V
V <sub>IT+</sub> (OVLO1)	OVLO threshold of V <sub>CC1</sub> rising	UVOV1_LEVEL = 0	4.0	4.15	4.3	V
V <sub>IT+</sub> (OVLO1)	OVLO threshold of V <sub>CC1</sub> rising	UVOV1_LEVEL = 1	5.5	5.65	5.8	V
V <sub>HYS</sub> (OVLO1)	OVLO threshold hysteresis of V <sub>CC1</sub>			0.30		V
t <sub>OVLO1</sub>	VCC1 OVLO detection deglitch time			20		μs
V <sub>IT+</sub> (UVLO2)	UVLO threshold voltage of V <sub>CC2</sub> rising with reference to GND2	UVLO2TH = 00b	15.2	16	16.8	V
		UVLO2TH = 01b	13.3	14	14.7	V
		UVLO2TH = 10b	11.4	12	12.6	V
		UVLO2TH = 11b	9.5	10	10.5	V
V <sub>IT-</sub> (UVLO2)	UVLO threshold voltage of V <sub>CC2</sub> falling with reference to GND2	UVLO2TH = 00b	14.25	15	15.75	V
		UVLO2TH = 01b	12.35	13	13.65	V
		UVLO2TH = 10b	10.45	11	11.55	V
		UVLO2TH = 11b	8.55	9	9.45	V
V <sub>HYS</sub> (UVLO2)	UVLO threshold voltage hysteresis of V <sub>CC2</sub>		1		V	
t <sub>UVLO2</sub>	VCC2 UVLO detection deglitch time		20		μs	
V <sub>IT-</sub> (OVLO2)	OVLO threshold voltage of V <sub>CC2</sub> falling with reference to GND2	OVLO2TH = 00b	21.85	23	24.15	V
		OVLO2TH = 01b	19.95	21	22.05	V
		OVLO2TH = 10b	18.05	19	19.95	V
		OVLO2TH = 11b	16.15	17	17.85	V

## 6.8 Electrical Characteristics (continued)

Over recommended operating conditions unless otherwise noted.

PARAMETER		TEST CONDITIONS	MIN	TYP	MAX	UNIT
V <sub>IT+</sub> (OVLO2)	OVLO threshold voltage of V <sub>CC2</sub> rising with reference to GND2	OVLO2TH = 00b	22.8	24	25.2	V
		OVLO2TH = 01b	20.9	22	23.1	V
		OVLO2TH = 10b	19	20	21	V
		OVLO2TH = 11b	17.1	18	18.9	V
V <sub>HYS</sub> (OVLO2)	OVLO threshold voltage hysteresis of V <sub>CC2</sub>		1		V	
t <sub>OVLO2</sub>	VCC2 OVLO detection blanking time		20		μs	
V <sub>IT-</sub> (UVLO3)	UVLO threshold voltage of V <sub>EE2</sub> falling with reference to GND2	UVLO3TH = 00b	-3.15	-3	-2.85	V
		UVLO3TH = 01b	-5.25	-5	-4.75	V
		UVLO3TH = 10b	-8.4	-8	-7.6	V
		UVLO3TH = 11b	-10.5	-10	-9.5	V
V <sub>IT+</sub> (UVLO3)	UVLO threshold voltage of V <sub>EE2</sub> rising with reference to GND2	UVLO3TH = 00b	-2.1	-2	-1.9	V
		UVLO3TH = 01b	-4.2	-4	-3.8	V
		UVLO3TH = 10b	-7.35	-7	-6.65	V
		UVLO3TH = 11b	-9.45	-9	-8.55	V
V <sub>HYS</sub> (UVLO3)	UVLO threshold voltage hysteresis of V <sub>EE2</sub>		1		V	
t <sub>UVLO3</sub>	VEE2 UVLO detection blanking time		20		μs	
V <sub>IT+</sub> (OVLO3)	OVLO threshold voltage of V <sub>EE2</sub> rising with reference to GND2	OVLO3TH = 00b	-5.25	-5	-4.75	V
		OVLO3TH = 01b	-7.35	-7	-6.65	V
		OVLO3TH = 10b	-10.5	-10	-9.5	V
		OVLO3TH = 11b	-12.6	-12	-11.4	V
V <sub>IT-</sub> (OVLO3)	OVLO threshold voltage of V <sub>EE2</sub> falling with reference to GND2	OVLO3TH = 00b	-6.3	-6	-5.7	V
		OVLO3TH = 01b	-8.4	-8	-7.6	V
		OVLO3TH = 10b	-11.55	-11	-10.45	V
		OVLO3TH = 11b	-13.65	-13	-12.35	V
V <sub>HYS(OVLO3)</sub>	OVLO threshold voltage hysteresis of V <sub>EE2</sub>		1		V	
t <sub>OVLO3</sub>	VEE2 OVLO detection blanking time		20		μs	
I <sub>QVCC1</sub>	Quiescent Current of V <sub>CC1</sub>	No switching, VCC1 = 5V			7.7	mA
I <sub>QVCC2</sub>	Quiescent Current of V <sub>CC2</sub>	No switching, VCC2 = 20V, VEE2 = -10V			15	mA
I <sub>QVEE2</sub>	Quiescent Current of V <sub>EE2</sub>	No switching, VCC2 = 20V, VEE2 = -10V			15	mA
t <sub>RP(VCC1)</sub>	Slew rate of V <sub>CC1</sub>				0.1	V/μs
t <sub>RP(VCC2)</sub>	Slew rate of V <sub>CC2</sub>				0.1	V/μs
t <sub>RP(VEE2)</sub>	Slew rate of V <sub>EE2</sub>				0.1	V/μs
<b>LOGIC IO</b>						
V <sub>IH</sub>	Input-high threshold voltage of primary IO (IN+, IN-, ASC, and ASC_EN)	Input rising, VCC1 = 3.3V		0.7*V <sub>CC1</sub>		V
	Input-high threshold voltage of secondary IO in ASC mode (AI5, and AI6)	Input rising, VREF=4V		3.0		V
V <sub>IL</sub>	Input-low threshold voltage of primary IO (IN+, IN-, ASC, and ASC_EN)	VCC1 = 3.3V	0.3*V <sub>CC1</sub>			V
	Input-low input-threshold voltage of secondary IO in ASC mode (AI5 and AI6)	Input falling	1.5			V

## 6.8 Electrical Characteristics (continued)

Over recommended operating conditions unless otherwise noted.

PARAMETER		TEST CONDITIONS	MIN	TYP	MAX	UNIT
V <sub>HYS(IN)</sub>	Input hysteresis voltage of primary IO (IN+, IN-, ASC, and ASC_EN)	V <sub>CC1</sub> =3.3V		0.1*V <sub>CC1</sub>		V
	Input hysteresis voltage of secondary IO in ASC mode (AI5, and AI6)			0.5		V
I <sub>LI</sub>	Leakage current on the input IO pins ASC, ASC_EN, IN+, IN-, CLK, and SDI	V <sub>IO</sub> = GND1, V <sub>IO</sub> is the voltage on IO pins			5	μA
	Leakage current on nCS	V <sub>IO</sub> = V <sub>CC1</sub> , V <sub>IO</sub> is the voltage on IO pins			5	μA
R <sub>PUI</sub>	Pullup resistance for nCS		40		100	kΩ
R <sub>PDI</sub>	Pulldown resistance for ASC, ASC_EN, IN+, IN-, CLK, and SDI		40		100	kΩ
	Pulldown resistance for AI5 and AI6 in ASC mode		800		1200	kΩ
V <sub>OH</sub>	Output logic-high voltage (SDO)	4.5mA output current, V <sub>CC1</sub> = 5V	0.9*V <sub>CC1</sub>			V
V <sub>OL</sub>	Output logic-low voltage (nFLT1, nFLT2, and SDO)	4.5mA sink current, V <sub>CC1</sub> = 5V		0.1*V <sub>CC1</sub>		V
f <sub>DOUT</sub>	Output frequency of DOUT pin	FREQ_DOUT = 00b		13.9		kHz
		FREQ_DOUT = 01b		27.8		kHz
		FREQ_DOUT = 10b		55.7		kHz
		FREQ_DOUT = 11b		111.4		kHz
D <sub>DOUT</sub>	Duty of DOUT	V <sub>AI*</sub> = 0.36 V		10		%
		V <sub>AI*</sub> = 1.8 V		50		%
		V <sub>AI*</sub> = 3.24 V		90		%
I <sub>LO</sub>	Leakage current on pin nFLT*	nFLT* = HiZ, V <sub>CC1</sub> on nFLT* pin	-5		5	μA
	Leakage current on pin SDO	nCS = 1	-5		5	μA
R <sub>PUO</sub>	Pullup resistance for pin nFLT*		40		100	kΩ
<b>DRIVER STAGE</b>						
V <sub>OUTH</sub>	High-level output voltage (OUT and OUTH)	I <sub>OUT</sub> = -100 mA		V <sub>CC2</sub> – 0.033		V
V <sub>OUTL</sub>	Low-level output voltage (OUT and OUTL)	I <sub>OUT</sub> = 100 mA			33	mV
I <sub>OUTH</sub>	Gate driver high output current	IN+ = high, IN- = low, V <sub>CC2</sub> - V <sub>OUTH</sub> = 5 V	15			A
I <sub>OUTL</sub>	Gate driver low output current	IN- = low, IN + = high, V <sub>OUTL</sub> - V <sub>EE2</sub> = 5 V	15			A
I <sub>STO</sub>	Driver low output current during SC and OC faults	V <sub>OUTL</sub> - V <sub>EE2</sub> = 6 V and STO_CURR = 00b, 100°C to 150°C	0.24	0.3	0.36	A
		V <sub>OUTL</sub> - V <sub>EE2</sub> = 6 V and STO_CURR = 01b, 100°C to 150°C	0.48	0.6	0.72	A
		V <sub>OUTL</sub> - V <sub>EE2</sub> = 6 V and STO_CURR = 10b, 100°C to 150°C	0.72	0.9	1.08	A
		V <sub>OUTL</sub> - V <sub>EE2</sub> = 6 V and STO_CURR = 11b, 100°C to 150°C	0.96	1.2	1.44	A
<b>ACTIVE MILLER CLAMP</b>						
V <sub>CLP</sub>	Low-level clamp voltage (internal Miller clamp)	I <sub>CLP</sub> = 100 mA			100	mV
	Miller clamp current	MCLPTH=11b, V <sub>CLAMP</sub> = V <sub>EE2</sub> +4 V	3.2			A

## 6.8 Electrical Characteristics (continued)

Over recommended operating conditions unless otherwise noted.

PARAMETER		TEST CONDITIONS	MIN	TYP	MAX	UNIT
V <sub>CLPTH</sub>	Clamp threshold voltage with reference to VEE2	MCLPTH = 00b	1.2	1.5	1.8	V
		MCLPTH = 01b	1.6	2	2.5	V
		MCLPTH = 10b	2.25	3	3.75	V
		MCLPTH = 11b	3	4	5	V
V <sub>ECLP</sub>	CLAMP output voltage in external Miller clamp mode		4.5	5	5.5	V
R <sub>ECLP_PD</sub>	CLAMP pull-down resistance in external Miller clamp mode		13			Ω
R <sub>ECLP_PU</sub>	CLAMP pull-up resistance in external Miller clamp mode		13			Ω
<b>SHORT CIRCUIT CLAMPING</b>						
V <sub>CLP-OUT</sub>	Clamping voltage (V <sub>OUTH</sub> - V <sub>CC2</sub> , V <sub>CLAMP</sub> - V <sub>CC2</sub> )	IN+ = high, IN- = low, t <sub>CLP</sub> = 10us, I <sub>OUTH</sub> or I <sub>CLAMP</sub> = 500 mA		0.8	1.6	V
<b>ACTIVE PULLDOWN</b>						
V <sub>OUTSD</sub>	Active shut-down voltage on OUTL	I <sub>OUTL</sub> = 30mA, V <sub>CC2</sub> = open			1.55	V
V <sub>OUTSD</sub>	Active shut-down voltage on OUTL	I <sub>OUTL</sub> = 0.1xI <sub>OUTL</sub> , V <sub>CC2</sub> = open			2.5	V
<b>DESAT SHORT-CIRCUIT PROTECTION</b>						
V <sub>DESATth</sub>	DESAT detection threshold voltage with respect to GND2	DESATTH = 0000b	2.25	2.5	2.75	V
		DESATTH = 0001b	2.7	3	3.3	V
		DESATTH = 0010b	3.15	3.5	3.85	V
		DESATTH = 0011b	3.6	4	4.4	V
		DESATTH = 0100b	4.05	4.5	4.95	V
		DESATTH = 0101b	4.5	5	5.5	V
		DESATTH = 0110b	4.95	5.5	6.05	V
		DESATTH = 0111b	5.4	6	6.6	V
		DESATTH = 1000b	5.85	6.5	7.15	V
		DESATTH = 1001b	6.3	7	7.7	V
		DESATTH = 1010b	6.75	7.5	8.25	V
		DESATTH = 1011b	7.2	8	8.8	V
		DESATTH = 1100b	7.65	8.5	9.35	V
		DESATTH = 1101b	8.1	9	9.9	V
DESATTH = 1110b	8.55	9.5	10.45	V		
DESATTH = 1111b	9	10	11	V		
V <sub>DESATL</sub>	DESAT voltage with respect to GND2 when OUTL is driven low				1	V
I <sub>CHG</sub>	Blanking capacitor charging current	V(DESAT) - GND2 = 2 V, DESAT_CHG_CURR = 00b	0.555	0.6	0.645	mA
		V(DESAT) - GND2 = 2 V, DESAT_CHG_CURR = 01b	0.6475	0.7	0.7525	mA
		V(DESAT) - GND2 = 2 V, DESAT_CHG_CURR = 10b	0.74	0.8	0.86	mA
		V(DESAT) - GND2 = 2 V, DESAT_CHG_CURR = 11b	0.925	1	1.075	mA
I <sub>DCHG</sub>	Blanking capacitor discharging current	V(DESAT) - GND2 = 6 V	14			mA
t <sub>LEB</sub>	DESAT leading edge blanking time		127	158	250	ns
t <sub>DESFLT</sub>	DESAT pin glitch filter	DESAT_DEGLITCH=0	90	158	190	ns
t <sub>DESFLT</sub>	DESAT pin glitch filter	DESAT_DEGLITCH=1	270	316	401	ns

## 6.8 Electrical Characteristics (continued)

Over recommended operating conditions unless otherwise noted.

PARAMETER		TEST CONDITIONS	MIN	TYP	MAX	UNIT
$t_{\text{DESAT}}(90\%)$	DESAT protection reaction time from event to action (includes deglitch time)	$V_{\text{DESAT}} > V_{\text{DESATth}}$ to $V_{\text{OUTL}}$ 90% of $V_{\text{CC2}}$ , $C_{\text{LOAD}} = 1 \text{ nF}$ , $\text{DESAT\_DEGLITCH} = 0$			160 + $t_{\text{DESFLT}}$	ns
<b>OVERCURRENT PROTECTION</b>						
$V_{\text{OCTH}}$	Over current detection threshold voltage	OCTH = 0000b	170	200	225	mV
		OCTH = 0001b	220	250	275	mV
		OCTH = 0010b	270	300	330	mV
		OCTH = 0011b	315	350	375	mV
		OCTH = 0100b	360	400	440	mV
		OCTH = 0101b	410	450	475	mV
		OCTH = 0110b	460	500	525	mV
		OCTH = 0111b	520	550	575	mV
		OCTH = 1000b	570	600	630	mV
		OCTH = 1001b	610	650	690	mV
		OCTH = 1010b	660	700	740	mV
		OCTH = 1011b	710	750	790	mV
		OCTH = 1100b	760	800	840	mV
		OCTH = 1101b	807	850	893	mV
		OCTH = 1110b	855	900	945	mV
OCTH = 1111b	902	950	998	mV		
$V_{\text{SCTH}}$	Short circuit protection threshold	SCTH = 00b	460	500	530	mV
		SCTH = 01b	700	750	785	mV
		SCTH = 10b	945	1000	1050	mV
		SCTH = 11b	1185	1250	1312	mV
$t_{\text{SCBLK}}$	Short circuit protection blanking time with reference to system clock	SC_BLK = 00b		100		ns
		SC_BLK = 01b		200		ns
		SC_BLK = 10b		400		ns
		SC_BLK = 11b		800		ns
$t_{\text{OCBLK}}$	Over current protection blanking time with reference to system clock	OC_BLK = 000b		500		ns
		OC_BLK = 001b		1000		ns
		OC_BLK = 010b		1500		ns
		OC_BLK = 011b		2000		ns
		OC_BLK = 100b		2500		ns
		OC_BLK = 101b		3000		ns
		OC_BLK = 110b		5000		ns
		OC_BLK = 111b		10000		ns
$t_{\text{SCFLT}}$	Short circuit protection deglitch filter		50	150	200	ns
$t_{\text{OCFLT}}$	Over current protection deglitch filter		50	150	200	ns
$t_{\text{SC}(90\%)}$	Short circuit protection reaction time from event to action (includes deglitch time)	$V_{\text{AIX}} > V_{\text{SCTH}}$ to $V_{\text{OUTL}}$ at 90% of $V_{\text{CC2}}$ , $C_{\text{LOAD}} = 1 \text{ nF}$ , $t_{\text{SCBLK}}$ expired			175 + $t_{\text{SCFLT}}$	ns
$t_{\text{OC}(90\%)}$	Over current protection reaction time from event to action (includes deglitch time)	$V_{\text{AIX}} > V_{\text{OCTH}}$ to $V_{\text{OUTL}}$ at 90% of $V_{\text{CC2}}$ , $C_{\text{LOAD}} = 1 \text{ nF}$ , $t_{\text{OCBLK}}$ expired			175 + $t_{\text{OCFLT}}$	ns
<b>TWO-LEVEL TURN-OFF PLATEAU VOLTAGE LEVEL</b>						

## 6.8 Electrical Characteristics (continued)

Over recommended operating conditions unless otherwise noted.

PARAMETER		TEST CONDITIONS	MIN	TYP	MAX	UNIT
V <sub>2 LOFF</sub>	Plateau voltage (with respect to GND2) during two-level turnoff	2LOFF_VOLT = 000b	5	6	7	V
		2LOFF_VOLT = 001b	6	7	8	V
		2LOFF_VOLT = 010b	7	8	9	V
		2LOFF_VOLT = 011b	8	9	10	V
		2LOFF_VOLT = 100b	9	10	11	V
		2LOFF_VOLT = 101b	10	11	12	V
		2LOFF_VOLT = 110b	11	12	13	V
		2LOFF_VOLT = 111b	12	13	14	V
t <sub>2 LOFF</sub>	Plateau voltage during two-level turnoff hold time	2LOFF_TIME = 000b		150		ns
		2LOFF_TIME = 001b		300		ns
		2LOFF_TIME = 010b		450		ns
		2LOFF_TIME = 011b		600		ns
		2LOFF_TIME = 100b		1000		ns
		2LOFF_TIME = 101b		1500		ns
		2LOFF_TIME = 110b		2000		ns
		2LOFF_TIME = 111b		2500		ns
I <sub>2 LOFF</sub>	Discharge current for transition to plateau voltage level	2LOFF_CURR = 00b, 100°C to 150°C	0.24	0.3	0.36	A
		2LOFF_CURR = 01b, 100°C to 150°C	0.48	0.6	0.72	A
		2LOFF_CURR = 10b, 100°C to 150°C	0.72	0.9	1.08	A
		2LOFF_CURR = 11b, 100°C to 150°C	0.96	1.2	1.44	A
<b>HIGH VOLTAGE CLAMPING</b>						
V <sub>CECLPTH</sub>	VCE clamping threshold with respect to VEE2		1.5	2.2	2.9	V
V <sub>CECLPHY S</sub>	VCE clamping threshold hysteresis			200		mV
t <sub>VCECLP</sub>	VCE clamping intervention-time			30		ns
t <sub>VCECLP_H LD</sub>	VCE clamping hold on time	VCE_CLMP_HLD_TIME = 00b		100		ns
		VCE_CLMP_HLD_TIME = 01b		200		ns
		VCE_CLMP_HLD_TIME = 10b		300		ns
		VCE_CLMP_HLD_TIME = 11b		400		ns
<b>OVERTEMPERATURE PROTECTION</b>						
T <sub>SD_SET</sub>	Overtemperature protection set for driver		155			°C
T <sub>SD_CLR</sub>	Overtemperature protection clear for driver		135			°C
T <sub>WN_SET</sub>	Overtemperature warning set for driver		130			°C
T <sub>WN_CLR</sub>	Overtemperature warning clear for driver		110			°C
T <sub>HYS</sub>	Hysteresis for thermal comparators			20		°C
I <sub>TO</sub>	Bias current for temp sensing diode for pins AI1, AI3, and AI5	TEMP_CURR = 00b, T <sub>j</sub> = 100C to 150C	0.097	0.1	0.103	mA
		TEMP_CURR = 01b, T <sub>j</sub> = 100C to 150C	0.291	0.3	0.309	mA
		TEMP_CURR = 10b, T <sub>j</sub> = 100C to 150C	0.582	0.6	0.618	mA
		TEMP_CURR = 11b, T <sub>j</sub> = 100C to 150C	0.97	1	1.03	mA

## 6.8 Electrical Characteristics (continued)

Over recommended operating conditions unless otherwise noted.

PARAMETER		TEST CONDITIONS	MIN	TYP	MAX	UNIT
V <sub>PS_TSDth</sub>	The threshold of power switch over temperature protection.	TSDTH_PS = 000b	0.95	1	1.05	V
		TSDTH_PS = 001b	1.1875	1.25	1.3125	V
		TSDTH_PS = 010b	1.425	1.5	1.575	V
		TSDTH_PS = 011b	1.6625	1.75	1.8375	V
		TSDTH_PS = 100b	1.9	2	2.1	V
		TSDTH_PS = 101b	2.1375	2.25	2.3625	V
		TSDTH_PS = 110b	2.375	2.5	2.625	V
		TSDTH_PS = 111b	2.6125	2.75	2.8875	V
t <sub>PS_TSDFL</sub> T	Power switch thermal shutdown deglitch time	PS_TSD_DEGLITCH = 00b		250		ns
		PS_TSD_DEGLITCH = 01b		500		ns
		PS_TSD_DEGLITCH = 10b		750		ns
		PS_TSD_DEGLITCH = 11b		1000		ns
<b>GATE VOLTAGE MONITOR</b>						
V <sub>GMH</sub>	Gate monitor threshold value with reference to VCC2	IN+= high and IN- = low	-4	-3	-2	V
V <sub>GML</sub>	Gate monitor threshold value with reference to VEE2	IN + = low and IN- = high	2	3	4	V
t <sub>GMBLK</sub>	Gate voltage monitor blanking time after driver receives PWM transition	GM_BLK = 00b		500		ns
		GM_BLK = 01b		1000		ns
		GM_BLK = 10b		2500		ns
		GM_BLK = 11b		4000		ns
t <sub>GMFLT</sub>	Gate voltage monitor deglitch time			250		ns
I <sub>VGTHM</sub>	Charge current for VGTH measurement	VCC2 - VOUTH = 10V		2		mA
t <sub>dVGTHM</sub>	Delay time between VGTH measurement control command to gate voltage sampling point.			2300		μs
<b>ADC</b>						
FSR	Full scale input voltage range for A1 to A6		0	3.6	3.636	V
V <sub>REF</sub>	Required voltage for external VREF	Accuracy of external reference directly affects the accuracy of the ADC		4		V
	Internal VREF output voltage			4		V
INL	Integral non-linearity	External reference, VREF = 4V	-1.2		1.2	LSB
		Internal reference	-4		9	LSB
DNL	Differential non-linearity	External reference, VREF = 4V	-0.75		0.75	LSB
		Internal reference	-0.75		0.75	LSB
t <sub>ADREFEXT</sub>	External ADC reference turn on delay time from VCC2 > V <sub>IT-(UVLO2)</sub>	V <sub>IT-(UVLO2)</sub> to 10% of VREF	10			μs
I <sub>TO2</sub>	Pull up current on AI2,4,6 pins	V <sub>AI2,4,6</sub> = VREF/2, ITO2_EN=H		10	15	μA
t <sub>hybrid</sub>	IN+ hold time to cause switchover between center mode and edge mode	ADC in hybrid mode configuration		0.4		ms
t <sub>CONV</sub>	Time to complete ADC conversion			5.1		μs
t <sub>RR</sub>	Time between ADC conversions in Edge mode	ADC in edge mode or hybrid mode (after t <sub>HYBRID</sub> ) configuration		7.5		μs

## 6.9 SPI Timing Requirements

		MIN	NOM	MAX	UNIT
$f_{\text{SPI}}$	SPI clock frequency <sup>(1)</sup>			4	MHz
$t_{\text{CLK}}$	SPI clock period <sup>(1)</sup>	250			ns
$t_{\text{CLKH}}$	CLK logic high duration <sup>(1)</sup>	90			ns
$t_{\text{CLKL}}$	CLK logic low duration <sup>(1)</sup>	90			ns
$t_{\text{SU\_NCS}}$	time between falling edge of nCS and rising edge of CLK <sup>(1)</sup>	50			ns
$t_{\text{SU\_SDI}}$	setup time of SDI before the falling edge of CLK <sup>(1)</sup>	30			ns
$t_{\text{HD\_SDI}}$	SDI data hold time <sup>(1)</sup>	45			ns
$t_{\text{D\_SDO}}$	time delay from rising edge of CLK to data valid at SDO <sup>(1)</sup>			60	ns
$t_{\text{HD\_SDO}}$	SDO output hold time <sup>(1)</sup>	40			ns
$t_{\text{HD\_NCS}}$	time between the falling edge of CLK and rising edge of nCS <sup>(1)</sup>	50			ns
$t_{\text{HI\_NCS}}$	SPI transfer inactive time <sup>(1)</sup>	250			ns
$t_{\text{ACC}}$	nCS low to SDO out of high impedance <sup>(1)</sup>		60	80	ns
$t_{\text{DIS}}$	time between rising edge of nCS and SDO in tri-state <sup>(1)</sup>		30	50	ns

(1) Ensured by bench characterization.

## 6.10 Switching Characteristics

over operating free-air temperature range (unless otherwise noted)

PARAMETER		TEST CONDITIONS	MIN	TYP	MAX	UNIT
$t_r$	OUTH rise time	$C_{\text{LOAD}} = 10 \text{ nF}$			150	ns
$t_f$	OUTL fall time	$C_{\text{LOAD}} = 10 \text{ nF}$			150	ns
$t_{\text{PLH}}, t_{\text{PHL}}$	Propagation delay from INP to OUTx	$C_{\text{LOAD}} = 0.1 \text{ nF}, t_{\text{GLITCH\_IO}} = 00\text{b}$			150	ns
$t_{\text{sk(p)}}$	Pulse skew $ t_{\text{PHL}} - t_{\text{PLH}} $	$C_{\text{LOAD}} = 0.1 \text{ nF}$		20	50	ns
$t_{\text{sk-pp}}$	Part-to-part skew - same edge	$C_{\text{LOAD}} = 0.1 \text{ nF}$		20	50	ns
$f_{\text{max}}$	Maximum switching frequency	$C_{\text{LOAD}} = 0.1 \text{ nF}, \text{ADC disabled}$			50	kHz
$t_{\text{dFLT1}}$	Delay from fault detection to nFLT1 pin goes LOW.	$C_{\text{LOAD}} = 100\text{pF}, R_{\text{EPU}} = 10\text{k}\Omega$			5	$\mu\text{s}$
$t_{\text{dFLT2}}$	Delay from fault detection to nFLT2 pin goes LOW.	$C_{\text{LOAD}} = 100\text{pF}, R_{\text{EPU}} = 10\text{k}\Omega$			25	$\mu\text{s}$
$t_{\text{ASC\_EN}}$	Required hold time for ASC after ASC_EN transition			1		$\mu\text{s}$
$t_{\text{ASC\_DLY}}$	Delay from the ASC edge to OUTx transition (primary side)	ASC rising	2			$\mu\text{s}$
		ASC falling		0.1		$\mu\text{s}$
$t_{\text{ASC\_DLY}}$	Delay from the AI6 (ASC) edge to OUTx transition (secondary side)	AI6 rising		1.8		$\mu\text{s}$
		AI6 falling		0.3		$\mu\text{s}$
$t_{\text{MUTE}}$	PWM input mute time in case of DESAT, SC, and PS_TSD fault	$\text{PWM\_MUTE\_EN} = 1$	10			ms
$t_{\text{GLITCH\_IO}}$	Deglitch time for the primary side IO pins (exclude nCS, CLK, SDI, and SDO pins)	$\text{IO\_DEGLITCH} = 00\text{b}$		0		ns
		$\text{IO\_DEGLITCH} = 01\text{b}$		70		ns
		$\text{IO\_DEGLITCH} = 10\text{b}$		140		ns
		$\text{IO\_DEGLITCH} = 11\text{b}$		210		ns
$t_{\text{DEAD}}$	Dead time for shoot through protection	$\text{TDEAD} = 000000\text{b}$		0		ns
		$\text{TDEAD} = 000001\text{b}$	93	105	154	ns
		$\text{TDEAD} = 000010\text{b}$	159	175	228	ns
		$\text{TDEAD} = 000011\text{b}$	225	245	302	ns
		$\text{TDEAD} = 000100\text{b}$	291	315	376	ns
		$\text{TDEAD} = 111111\text{b}$	4178.3	4445	4748.8	ns



## 6.10 Switching Characteristics (continued)

over operating free-air temperature range (unless otherwise noted)

PARAMETER		TEST CONDITIONS	MIN	TYP	MAX	UNIT
$t_{\text{STARTUP}}$	System start-up time (from power ready to nFLTx pins go high)				5	ms
$t_{\text{VREGxOV}}$	VREG1 and VREG2 overvoltage detection deglitch time			30		$\mu\text{s}$

## 6.11 Typical Characteristics

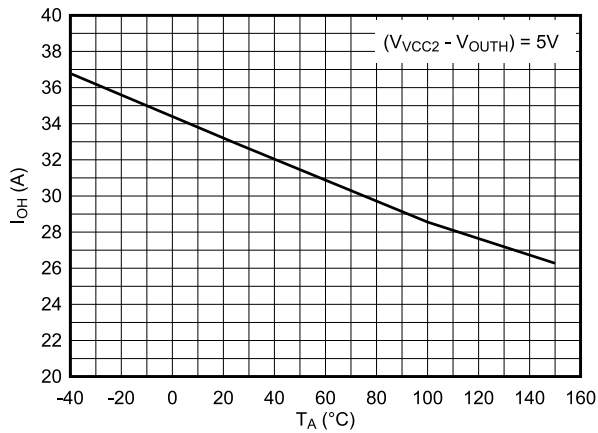


图 6-1.  $I_{OUTH}$  vs. Temperature

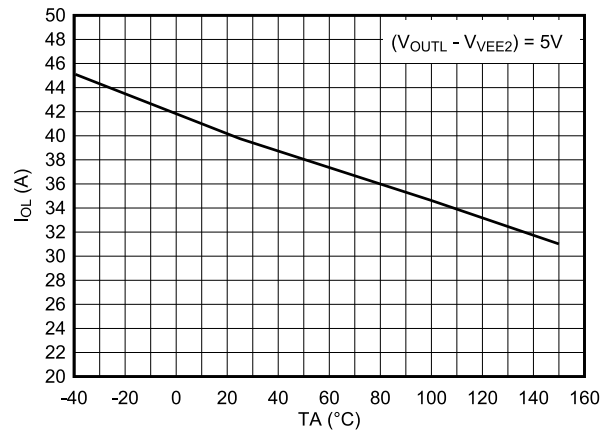


图 6-2.  $I_{OUTL}$  vs. Temperature

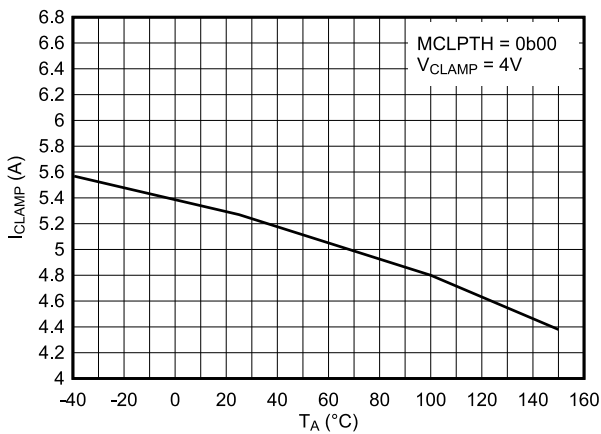


图 6-3. Internal Miller Clamp Current vs. Temperature

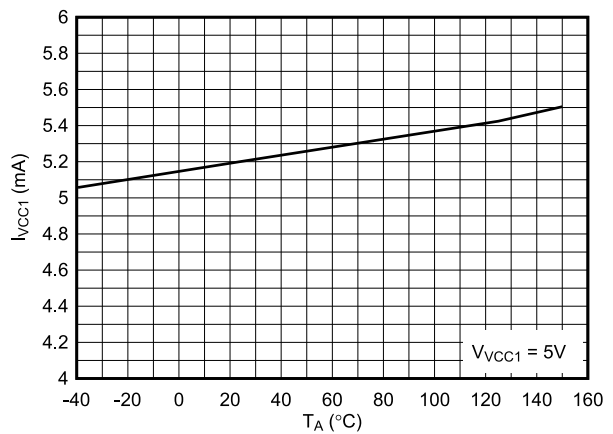


图 6-4.  $V_{CC1}$  Quiescent Current vs. Temperature

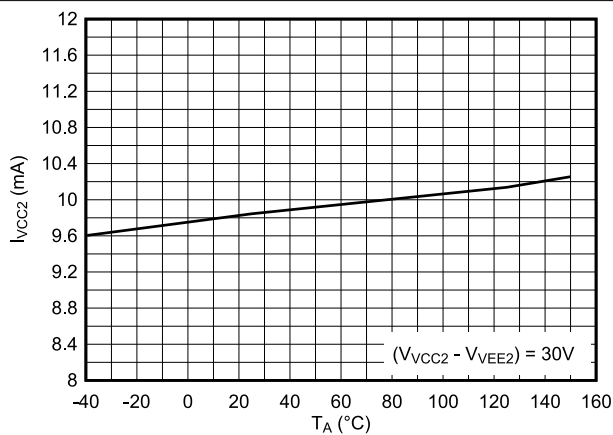


图 6-5.  $V_{CC2}$  Quiescent Current vs. Temperature

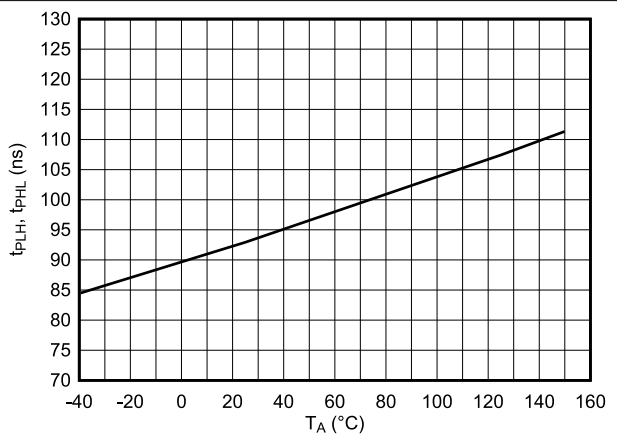


图 6-6. Propagation Delay vs. Temperature

### 6.11 Typical Characteristics (continued)

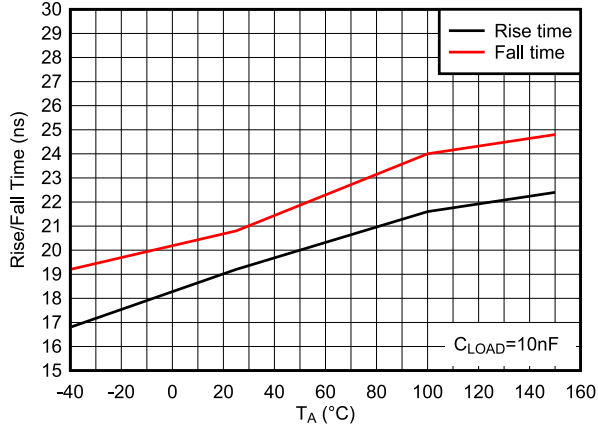


Figure 6-7. Rise/Fall Time vs. Temperature

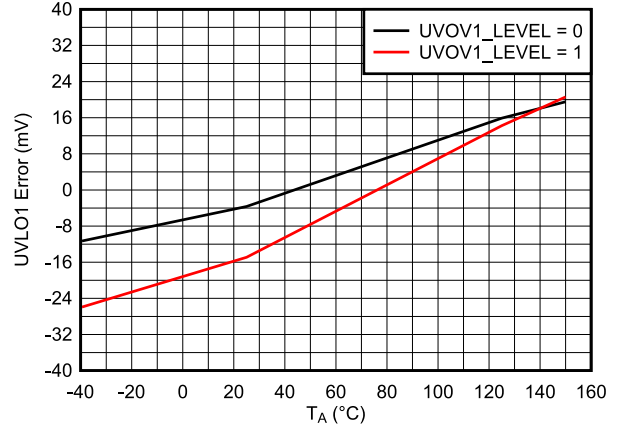


Figure 6-8. UVLO Threshold Error vs. Temperature

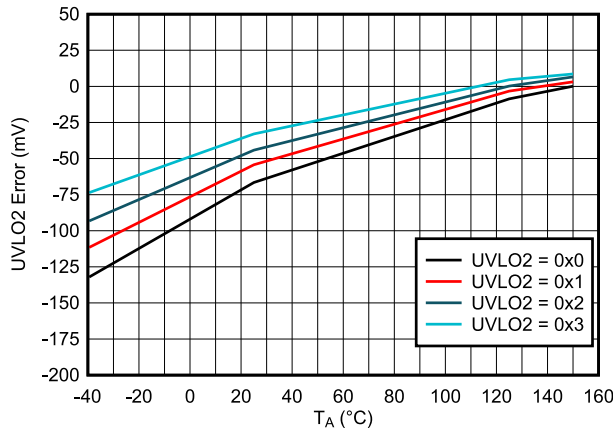


Figure 6-9. UVLO2 Error vs. Temperature

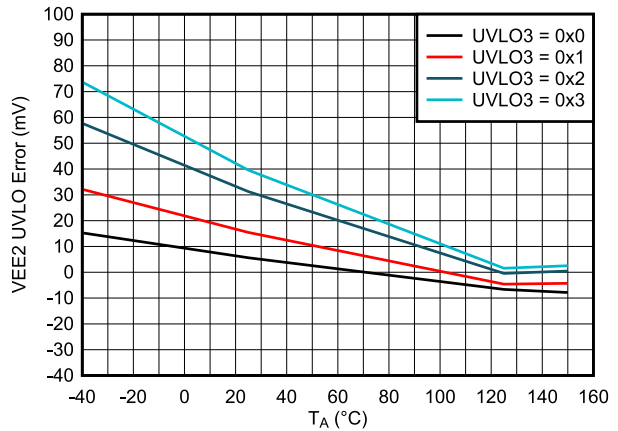


Figure 6-10. VEE2 UVLO Error vs. Temperature

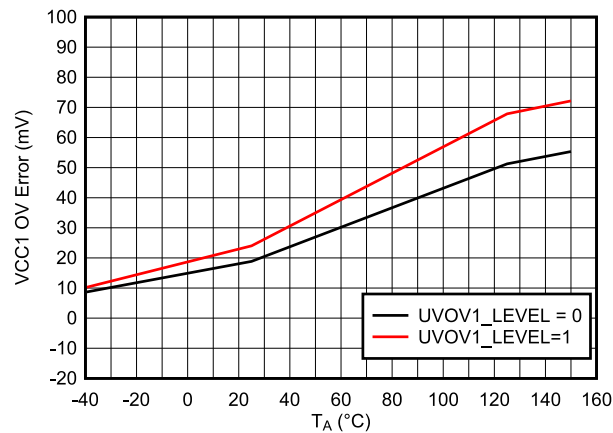


Figure 6-11. VCC1 OVLO Error vs. Temperature

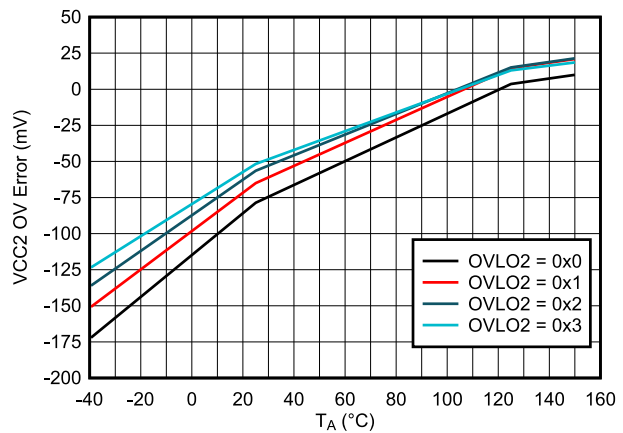


Figure 6-12. VCC2 OVLO Error vs. Temperature

### 6.11 Typical Characteristics (continued)

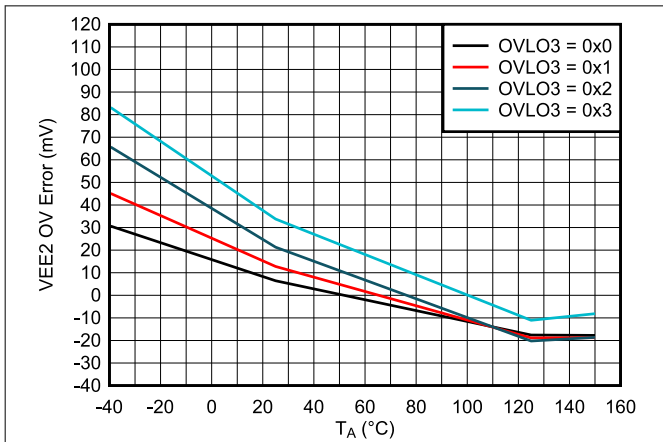


Figure 6-13. VEE2 OVLO Error vs. Temperature

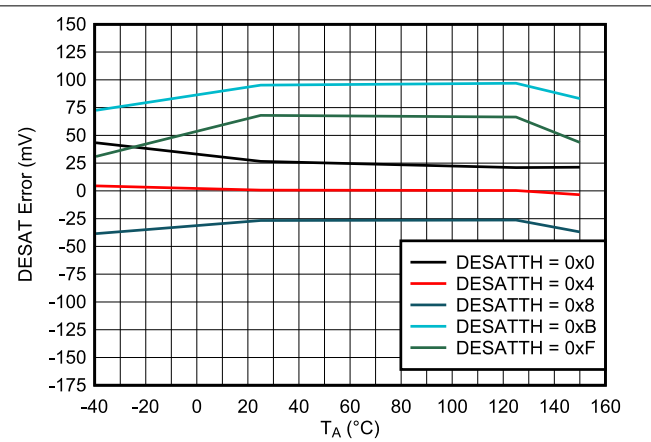


Figure 6-14. DESAT Threshold Error vs. Temperature

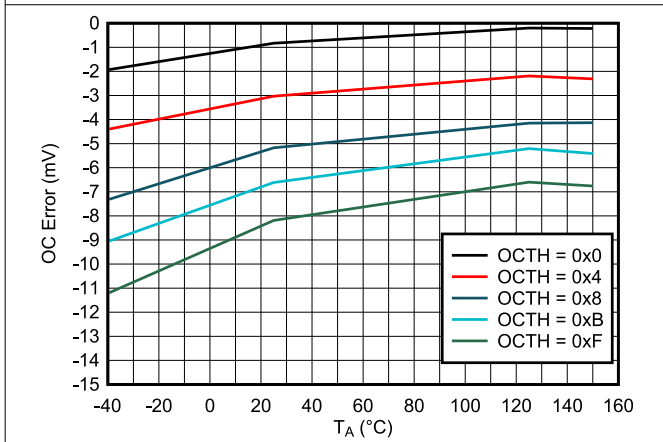


Figure 6-15. OC Threshold Error vs. Temperature

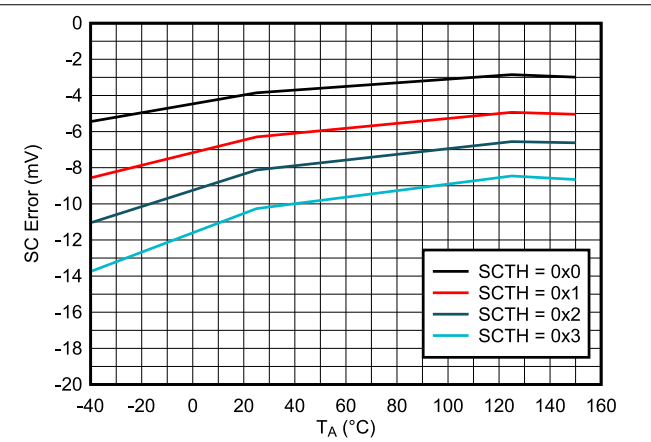


Figure 6-16. SC Threshold Error vs. Temperature

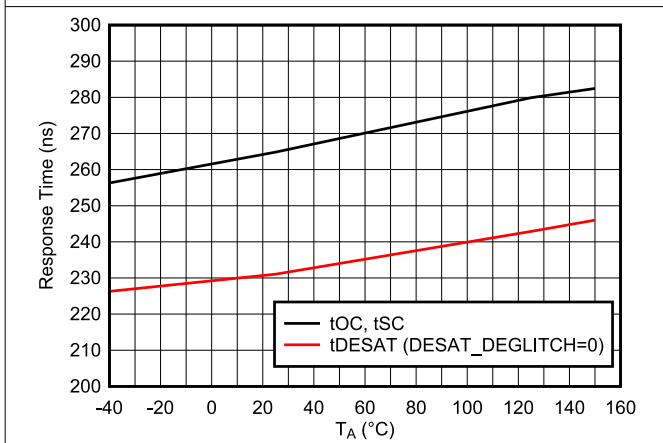


Figure 6-17. Overcurrent Protection Response Time vs. Temperature

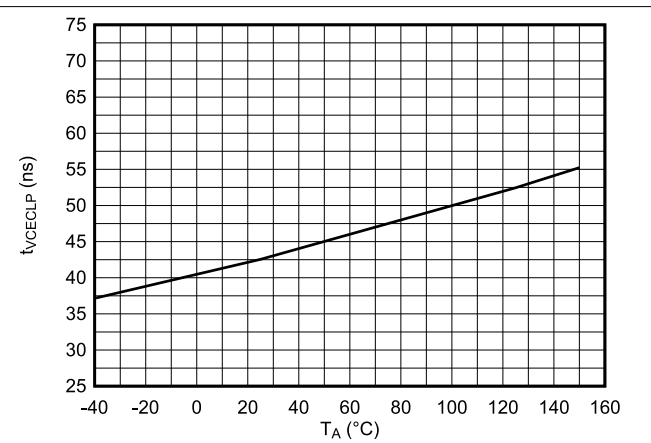
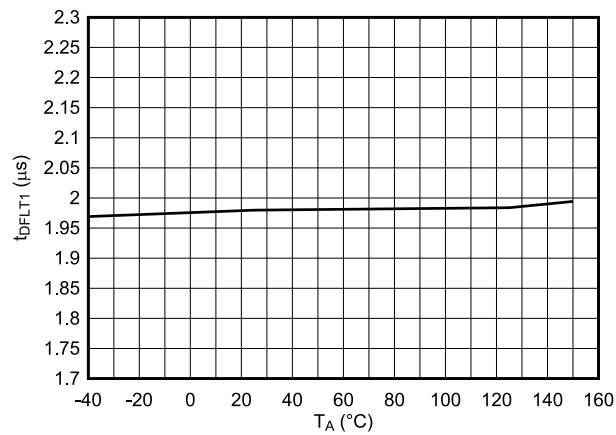


Figure 6-18. VCECLP Intervention Time vs. Temperature

## 6.11 Typical Characteristics (continued)



**6-19. nFLT1 Response Time vs Temperature**

## 7 Layout

### 7.1 Layout Guidelines

One must pay close attention to PCB layout in order to achieve optimum performance for the device.

#### 7.1.1 Component Placement

- Low-ESR and low-ESL capacitors must be connected close to the device between the VCC1 and GND1 pins and between the VCC2, VEE2 and GND2 pins to support high peak currents when turning on the external power transistor.
- Place the VBST and VREF caps as close to the device as possible.

#### 7.1.2 Grounding Considerations

- It is essential to confine the high peak currents that charge and discharge the transistor gates to a minimal physical area. This decreases the loop inductance and minimize noise on the gate terminals of the transistors. The gate driver must be placed as close as possible to the transistors.
- Pay attention to high current path that includes the bootstrap capacitor. The bootstrap capacitor is recharged on a cycle-by-cycle basis through the diode by the VCC2 bypass capacitor. This recharging occurs in a short time interval and involves a high peak current. Minimizing this loop length and area on the circuit board is important for ensuring reliable operation.

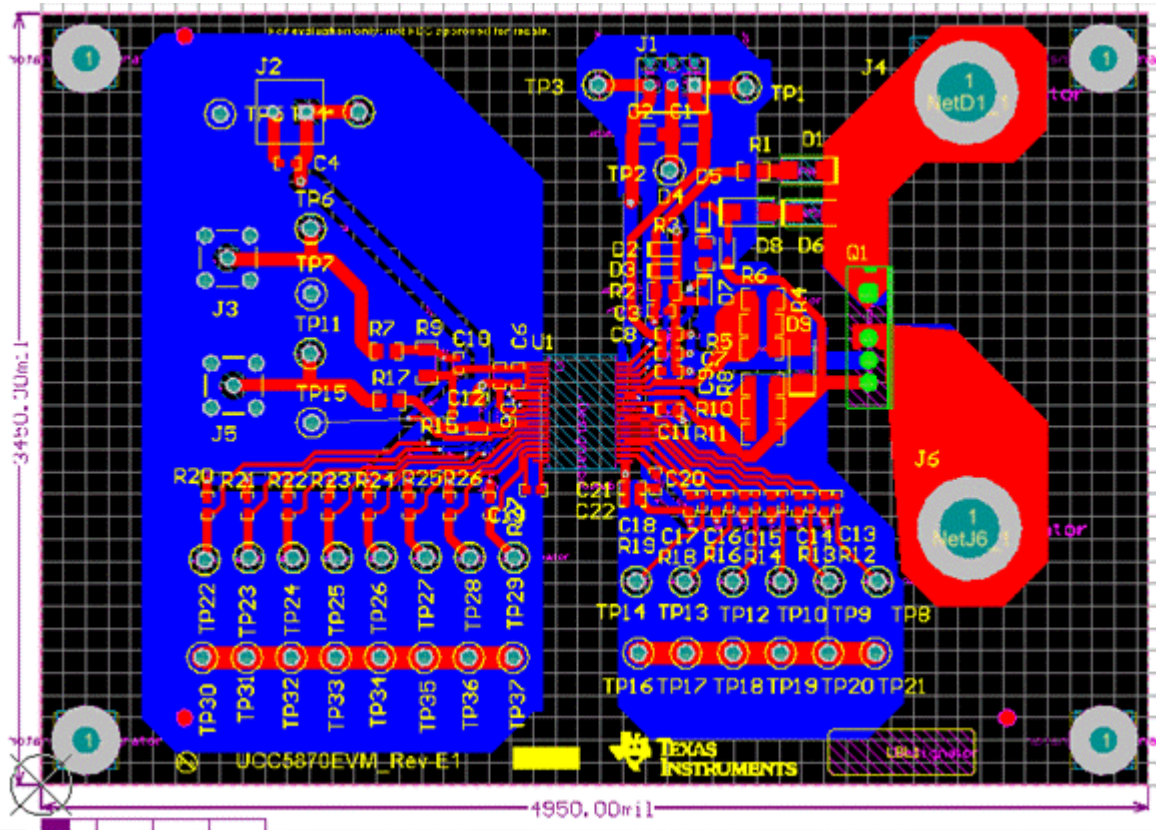
#### 7.1.3 High-Voltage Considerations


- To ensure isolation performance between the primary and secondary side, one should avoid placing any PCB traces or copper below the driver device. A PCB cutout is recommended in order to prevent contamination that may compromise the UCC51870's isolation performance.
- For half-bridge, or high-side/low-side configurations, where the high-side and low-side drivers could operate with a DC-link voltage up to 1000 VDC, one should try to increase the creepage distance of the PCB layout between the high and low-side PCB traces.

#### 7.1.4 Thermal Considerations

- The power dissipated by the device is directly proportional to the drive voltage, heavy capacitive loading, and/or high switching frequency. Proper PCB layout helps dissipate heat from the device to the PCB and minimize junction to board thermal impedance ( $\theta_{JB}$ ).
- Increasing the PCB copper connecting to VCC2 and VEE2 is recommended, with priority on maximizing the connection to VEE2. However, high voltage PCB considerations mentioned above must be maintained.
- If there are multiple layers in the system, it is also recommended to connect the VCC2 and VEE2 to internal ground or power planes through multiple vias of adequate size. However, keep in mind that there shouldn't be any traces/coppers from different high voltage planes overlapping.

## 7.2 Layout Example



 7-1. Layout Example

## 8 Device and Documentation Support

### 8.1 Device Support

#### 8.1.1 Third-Party Products Disclaimer

TI'S PUBLICATION OF INFORMATION REGARDING THIRD-PARTY PRODUCTS OR SERVICES DOES NOT CONSTITUTE AN ENDORSEMENT REGARDING THE SUITABILITY OF SUCH PRODUCTS OR SERVICES OR A WARRANTY, REPRESENTATION OR ENDORSEMENT OF SUCH PRODUCTS OR SERVICES, EITHER ALONE OR IN COMBINATION WITH ANY TI PRODUCT OR SERVICE.

### 8.2 Documentation Support

#### 8.2.1 Related Documentation

For related documentation see the following:

- [Digital Isolator Design Guide](#)
- [Isolation Glossary](#)
- [Documentation available to aid ISO 26262 system design up to ASIL D](#)

### 8.3 Receiving Notification of Documentation Updates

To receive notification of documentation updates, navigate to the device product folder on ti.com. In the upper right corner, click on *Alert me* to register and receive a weekly digest of any product information that has changed. For change details, review the revision history included in any revised document.

### 8.4 サポート・リソース

TI E2E™ サポート・フォーラムは、エンジニアが検証済みの回答と設計に関するヒントをエキスパートから迅速かつ直接得ることができる場所です。既存の回答を検索したり、独自の質問をしたりすることで、設計に必要な支援を迅速に得ることができます。

リンクされているコンテンツは、該当する貢献者により、現状のまま提供されるものです。これらは TI の仕様を構成するものではなく、必ずしも TI の見解を反映したものではありません。TI の [使用条件](#) を参照してください。

### 8.5 Trademarks

TI E2E™ is a trademark of Texas Instruments.

すべての商標は、それぞれの所有者に帰属します。

### 8.6 Electrostatic Discharge Caution



This integrated circuit can be damaged by ESD. Texas Instruments recommends that all integrated circuits be handled with appropriate precautions. Failure to observe proper handling and installation procedures can cause damage.

ESD damage can range from subtle performance degradation to complete device failure. Precision integrated circuits may be more susceptible to damage because very small parametric changes could cause the device not to meet its published specifications.

### 8.7 Glossary

[TI Glossary](#) This glossary lists and explains terms, acronyms, and definitions.

## 9 Mechanical, Packaging, and Orderable Information

The following pages include mechanical packaging and orderable information. This information is the most current data available for the designated devices. This data is subject to change without notice and revision of this document. For browser-based versions of this data sheet, refer to the left-hand navigation.



**PACKAGING INFORMATION**

Orderable Device	Status (1)	Package Type	Package Drawing	Pins	Package Qty	Eco Plan (2)	Lead finish/ Ball material (6)	MSL Peak Temp (3)	Op Temp (°C)	Device Marking (4/5)	Samples
UCC5871QDWJRQ1	ACTIVE	SSOP	DWJ	36	750	RoHS & Green	NIPDAU	Level-3-260C-168 HR	-40 to 125	UCC5871Q	Samples

(1) The marketing status values are defined as follows:

**ACTIVE:** Product device recommended for new designs.

**LIFEBUY:** TI has announced that the device will be discontinued, and a lifetime-buy period is in effect.

**NRND:** Not recommended for new designs. Device is in production to support existing customers, but TI does not recommend using this part in a new design.

**PREVIEW:** Device has been announced but is not in production. Samples may or may not be available.

**OBSELETE:** TI has discontinued the production of the device.

(2) **RoHS:** TI defines "RoHS" to mean semiconductor products that are compliant with the current EU RoHS requirements for all 10 RoHS substances, including the requirement that RoHS substance do not exceed 0.1% by weight in homogeneous materials. Where designed to be soldered at high temperatures, "RoHS" products are suitable for use in specified lead-free processes. TI may reference these types of products as "Pb-Free".

**RoHS Exempt:** TI defines "RoHS Exempt" to mean products that contain lead but are compliant with EU RoHS pursuant to a specific EU RoHS exemption.

**Green:** TI defines "Green" to mean the content of Chlorine (Cl) and Bromine (Br) based flame retardants meet JS709B low halogen requirements of <=1000ppm threshold. Antimony trioxide based flame retardants must also meet the <=1000ppm threshold requirement.

(3) MSL, Peak Temp. - The Moisture Sensitivity Level rating according to the JEDEC industry standard classifications, and peak solder temperature.

(4) There may be additional marking, which relates to the logo, the lot trace code information, or the environmental category on the device.

(5) Multiple Device Markings will be inside parentheses. Only one Device Marking contained in parentheses and separated by a "-" will appear on a device. If a line is indented then it is a continuation of the previous line and the two combined represent the entire Device Marking for that device.

(6) Lead finish/Ball material - Orderable Devices may have multiple material finish options. Finish options are separated by a vertical ruled line. Lead finish/Ball material values may wrap to two lines if the finish value exceeds the maximum column width.

**Important Information and Disclaimer:**The information provided on this page represents TI's knowledge and belief as of the date that it is provided. TI bases its knowledge and belief on information provided by third parties, and makes no representation or warranty as to the accuracy of such information. Efforts are underway to better integrate information from third parties. TI has taken and continues to take reasonable steps to provide representative and accurate information but may not have conducted destructive testing or chemical analysis on incoming materials and chemicals. TI and TI suppliers consider certain information to be proprietary, and thus CAS numbers and other limited information may not be available for release.

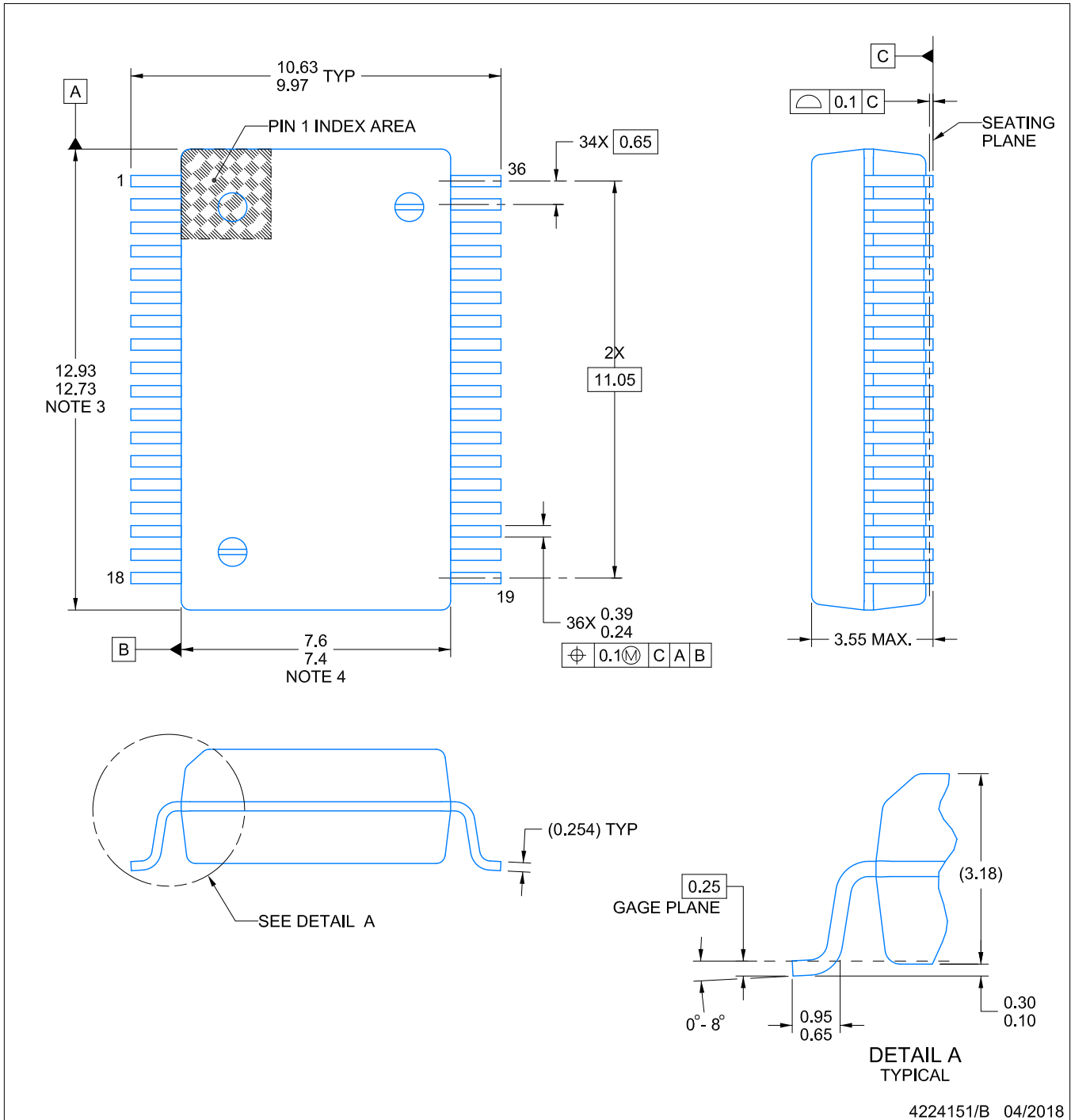
In no event shall TI's liability arising out of such information exceed the total purchase price of the TI part(s) at issue in this document sold by TI to Customer on an annual basis.

# PACKAGE OUTLINE

DWJ0036A

SSOP - 3.55 mm max height

SMALL OUTLINE PACKAGE



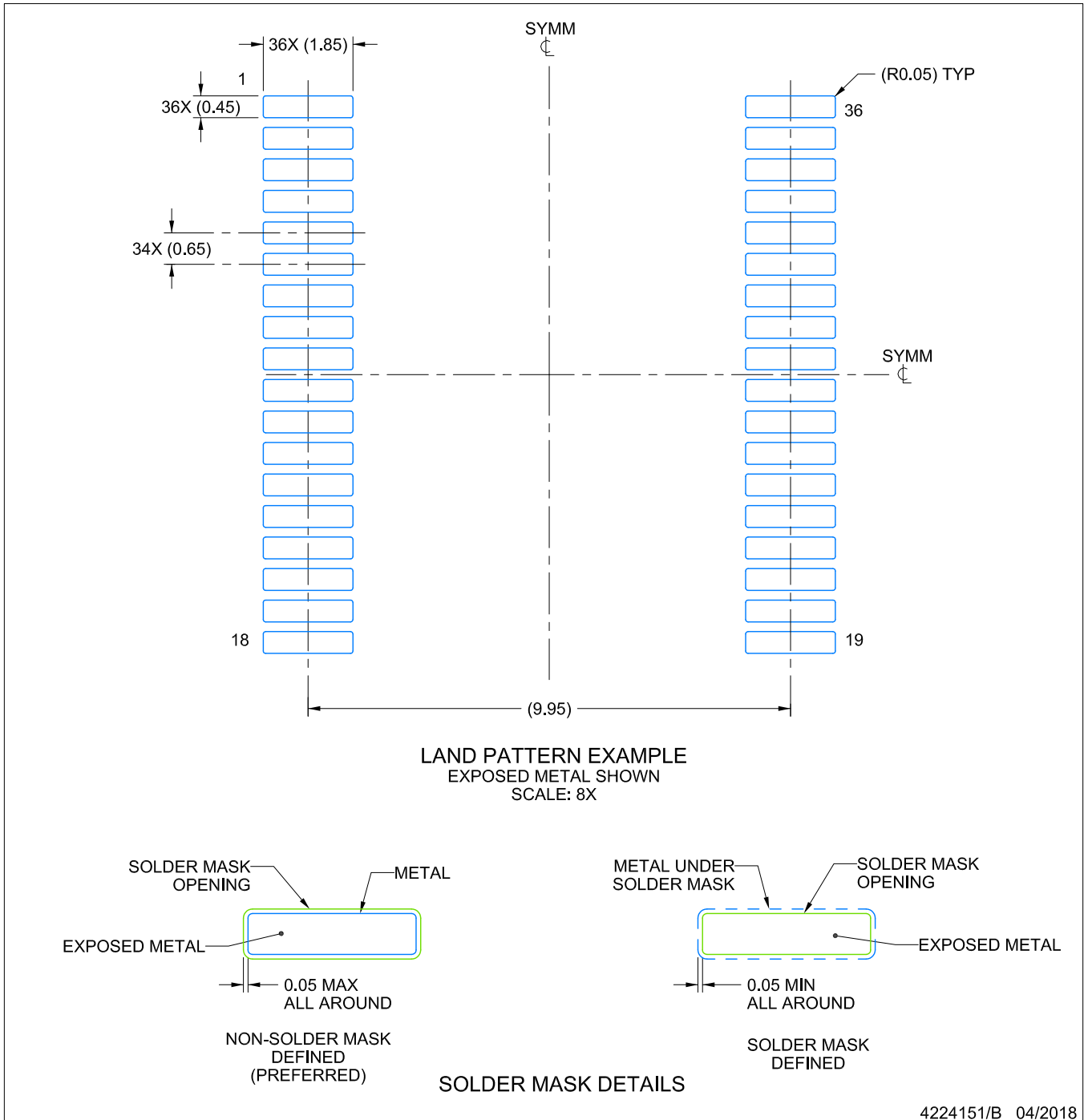
4224151/B 04/2018

# EXAMPLE BOARD LAYOUT

DWJ0036A

SSOP - 3.55 mm max height

SMALL OUTLINE PACKAGE



NOTES: (continued)

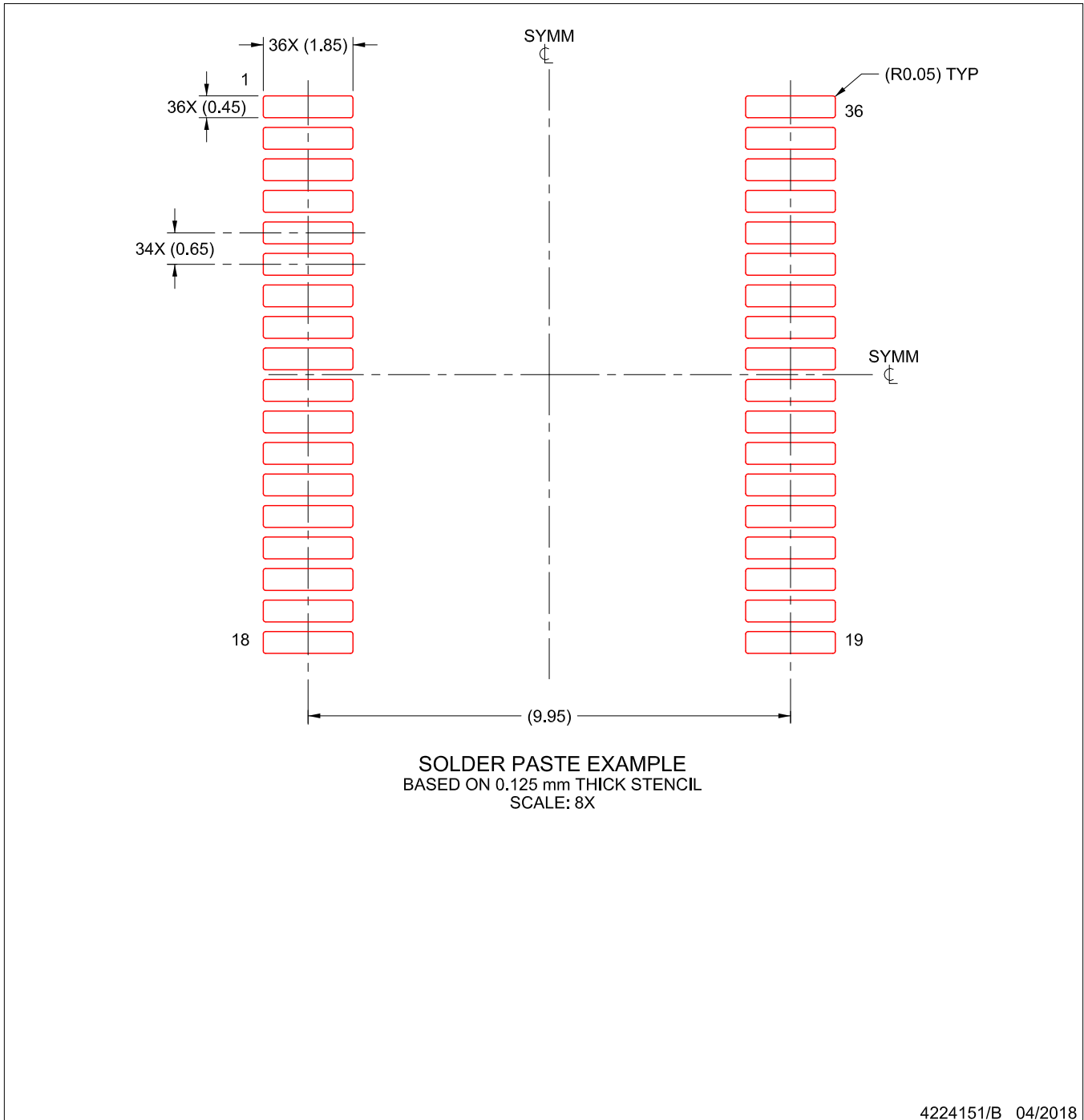
5. Publication IPC-7351 may have alternate designs.
6. Solder mask tolerances between and around signal pads can vary based on board fabrication site.

# EXAMPLE STENCIL DESIGN

DWJ0036A

SSOP - 3.55 mm max height

SMALL OUTLINE PACKAGE



NOTES: (continued)

7. Laser cutting apertures with trapezoidal walls and rounded corners may offer better paste release. IPC-7525 may have alternate design recommendations.
8. Board assembly site may have different recommendations for stencil design.

## 重要なお知らせと免責事項

TI は、技術データと信頼性データ (データシートを含みます)、設計リソース (リファレンス・デザインを含みます)、アプリケーションや設計に関する各種アドバイス、Web ツール、安全性情報、その他のリソースを、欠陥が存在する可能性のある「現状のまま」提供しており、商品性および特定目的に対する適合性の黙示保証、第三者の知的財産権の非侵害保証を含むいかなる保証も、明示的または黙示的にかかわらず拒否します。

これらのリソースは、TI 製品を使用する設計の経験を積んだ開発者への提供を意図したものです。(1) お客様のアプリケーションに適した TI 製品の選定、(2) お客様のアプリケーションの設計、検証、試験、(3) お客様のアプリケーションに該当する各種規格や、その他のあらゆる安全性、セキュリティ、規制、または他の要件への確実な適合に関する責任を、お客様のみが単独で負うものとし、

上記の各種リソースは、予告なく変更される可能性があります。これらのリソースは、リソースで説明されている TI 製品を使用するアプリケーションの開発の目的でのみ、TI はその使用をお客様に許諾します。これらのリソースに関して、他の目的で複製することや掲載することは禁止されています。TI や第三者の知的財産権のライセンスが付与されている訳ではありません。お客様は、これらのリソースを自身で使用した結果発生するあらゆる申し立て、損害、費用、損失、責任について、TI およびその代理人を完全に補償するものとし、TI は一切の責任を拒否します。

TI の製品は、[TI の販売条件](#)、または [ti.com](#) やかかる TI 製品の関連資料などのいずれかを通じて提供する適用可能な条項の下で提供されています。TI がこれらのリソースを提供することは、適用される TI の保証または他の保証の放棄の拡大や変更を意味するものではありません。

お客様がいかなる追加条項または代替条項を提案した場合でも、TI はそれらに異議を唱え、拒否します。

郵送先住所 : Texas Instruments, Post Office Box 655303, Dallas, Texas 75265  
Copyright © 2024, Texas Instruments Incorporated