

# UCC12051-Q1 高効率、低 EMI、5kV<sub>RMS</sub> 絶縁 DC/DC コンバータ

## 1 特長

- 内蔵トランス・テクノロジーを採用した高効率 DC-DC コンバータ
- 下記内容で AEC-Q100 認定済み:
  - デバイス温度グレード 1: -40°C ~ 125°C の動作時 周囲温度範囲
- 機能安全対応
  - 機能安全システムの設計に役立つ資料を利用可能
- 出力電力 (標準値): 500mW
- 5V または 3.3V 安定化出力 (LDO に給電するための 400mV のヘッドルーム電圧の有無を選択可能)
- 入力電圧: 4.5V ~ 5.5V
- 堅牢な絶縁バリア:
  - 絶縁定格: 5 kV<sub>RMS</sub>
  - サージ耐性: 10kV<sub>PK</sub>
  - 動作電圧: 1.2kV<sub>RMS</sub>
  - 最小 CMTI: 100V/ns
- 短絡からの回復
- サーマル・シャットダウン
- 沿面距離と空間距離が 8mm を超える 16 ピン幅広 SOIC パッケージ
- 安全関連認証 (予定):
  - DIN V VDE V 0884-11:2017-01 に準拠した強化絶縁耐圧: 7071V<sub>PK</sub>
  - UL 1577 に準拠した絶縁耐圧: 5000V<sub>RMS</sub>、1 分間
  - IEC 60950-1 および IEC 62368-1 最終機器規格 準拠の UL 認証
  - GB4943.1-2011 による CQC 認証

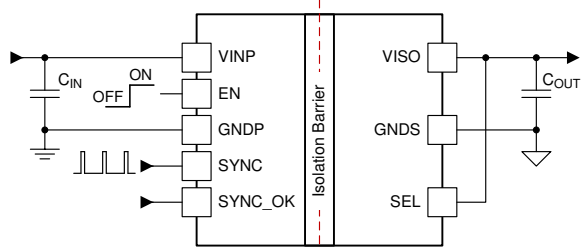

アプリケーション概略

## 2 アプリケーション

- オンボード・チャージャ
- バッテリー・マネージメント・システム
- トラクション・インバータ
- HEV/EV 用 DC/DC コンバータ

## 3 概要

UCC12051-Q1 は、5kV<sub>RMS</sub> の絶縁を備えた DC/DC パワー・モジュールであり、適切にレギュレートされた出力電圧のバイアス電源を必要とする絶縁回路に、高効率の絶縁電力を供給するよう設計されています。このデバイスは、独自のアーキテクチャによってトランスと DC/DC コントローラを統合しており、500mW (標準値) の絶縁電力を高効率かつ低 EMI で供給できます。

UCC12051-Q1 は、システムの堅牢性を向上させるための保護機能を内蔵しています。このデバイスはイネーブル・ピン、同期機能、5V または 3.3V 安定化出力選択機能 (ヘッドルームを選択可能) も備えています。UCC12051-Q1 は、高さ 2.65mm (標準値) の幅広 SOIC パッケージで供給される薄型の小型ソリューションです。

### 製品情報(1)

部品番号	パッケージ	本体サイズ (公称)
UCC12051-Q1	DVE SOIC (16)	10.30mm × 7.50mm

- (1) 利用可能なすべてのパッケージについては、このデータシートの末尾にある注文情報を参照してください。

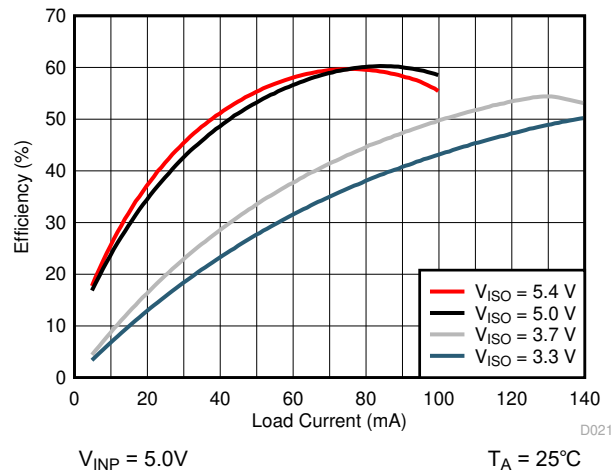

代表的な効率と負荷との関係



## Table of Contents

<b>1 特長</b> .....	1	7.2 Functional Block Diagram.....	14
<b>2 アプリケーション</b> .....	1	7.3 Feature Description.....	14
<b>3 概要</b> .....	1	7.4 Device Functional Modes.....	16
<b>4 Revision History</b> .....	2	<b>8 Application and Implementation</b> .....	17
<b>5 Pin Configuration and Functions</b> .....	3	8.1 Application Information.....	17
<b>6 Specifications</b> .....	4	8.2 Typical Application.....	17
6.1 Absolute Maximum Ratings.....	4	<b>9 Power Supply Recommendations</b> .....	23
6.2 ESD Ratings.....	4	<b>10 Layout</b> .....	23
6.3 Recommended Operating Conditions.....	4	10.1 Layout Guidelines.....	23
6.4 Thermal Information.....	4	10.2 Layout Example.....	24
6.5 Power Ratings.....	5	<b>11 Device and Documentation Support</b> .....	25
6.6 Insulation Specifications.....	5	11.1 Device Support.....	25
6.7 Safety-Related Certifications.....	6	11.2 Documentation Support.....	25
6.8 Safety Limiting Values.....	6	11.3 Receiving Notification of Documentation Updates..	25
6.9 Electrical Characteristics.....	7	11.4 サポート・リソース.....	25
6.10 Switching Characteristics.....	8	11.5 Trademarks.....	25
6.11 Insulation Characteristics Curves.....	9	11.6 Electrostatic Discharge Caution.....	25
6.12 Typical Characteristics.....	10	11.7 Glossary.....	25
<b>7 Detailed Description</b> .....	14	<b>12 Mechanical, Packaging, and Orderable Information</b> .....	25
7.1 Overview.....	14		

## 4 Revision History

資料番号末尾の英字は改訂を表しています。その改訂履歴は英語版に準じています。

Changes from Revision * (January 2021) to Revision A (June 2021)	Page
• ステータスを「事前情報」から「量産データ」に変更.....	1

## 5 Pin Configuration and Functions



図 5-1. DVE Package 16-Pin SOIC Top View

表 5-1. Pin Functions

PIN		TYPE (1)	DESCRIPTION
NAME	NO.		
EN	1	I	Enable pin. Forcing EN low disables the device. Pull high to enable normal device functionality.
GNDP	2	P	Power ground return connection for VINP.
GNDP	9	P	Connect to GNDP plane on printed circuit board. Do not use as only ground connection for VISO. Ensure pin 15 is connected to circuit ground.
	16		
GNDP	15	P	Secondary side ground return connection for VISO. Connect bypass capacitor from VISO to this pin.
NC	6	—	Pins internally connected together. No other electrical connection. Pins belong to primary-side voltage domain. Connect to GNDP on printed circuit board.
	7		
	8		
	10	—	No internal connection. Pin belongs to isolated voltage domain. Connect to GNDP on printed circuit board.
	11		
	12		
SYNC	4	I	Synchronous clock input pin. Provide a clock signal to synchronize multiple devices or connect to GNDP for standalone operation using the internal oscillator. If the SYNC pin is left open make sure to separate it from any switching noise to avoid false clock coupling.
SYNC_OK	5	O	Active-low, open-drain diagnostic output. Pin is asserted LOW if there is no external SYNC clock or one that is outside of the operating range of the is detected. In this state, the external clock is ignored and the DC/DC converter is clocked by the internal oscillator. The pin is in high-impedance if a clock is applied on SYNC.
SEL	13	I	V <sub>ISO</sub> selection pin. V <sub>ISO</sub> setpoint is 5.0 V when SEL is shorted to V <sub>ISO</sub> , 5.4 V when SEL is connected to V <sub>ISO</sub> through a 100-kΩ resistor, 3.3 V when SEL is shorted to GNDP, and 3.7 V when SEL is connected to GNDP through a 100-kΩ resistor. For more information see the <a href="#">セクション 7.4</a> section.
VINP	3	P	Primary side input supply voltage pin. A 10-μF ceramic capacitor to GNDP on pin 2, placed close to the device pins, is required.
VISO	14	P	Isolated supply voltage pin. A 10-μF ceramic capacitor to GNDP on pin 15, placed close to the device pins, is required. See <a href="#">セクション 8.2.2.1</a> section.

(1) P = Power, G = Ground, I = Input, O = Output

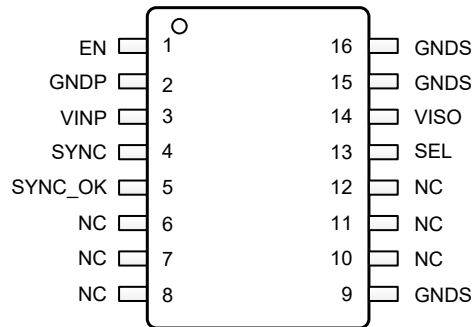
## 6 Specifications

### 6.1 Absolute Maximum Ratings

over operating free-air temperature range (unless otherwise noted)<sup>(1)</sup>

	MIN	MAX	UNIT
V <sub>INP</sub> to GNDP	-0.3	6.0	V
EN, SYNC, SYNC_OK, to GNDP	-0.3	V <sub>INP</sub> + 0.3, ≤ 6.0	V
V <sub>ISO</sub> to GNDS	-0.3	6.0	V
SEL to GNDS	-0.3	V <sub>ISO</sub> + 0.3, ≤ 6.0	V
V <sub>ISO</sub> output power at T <sub>a</sub> = 25°C, P <sub>OUT_MAX</sub> <sup>(2)</sup>		675	mW
Operating junction temperature range, T <sub>J</sub>	-40	150	°C
Storage temperature, T <sub>stg</sub>	-65	150	°C

- Stresses beyond those listed under *Absolute Maximum Ratings* may cause permanent damage to the device. These are stress ratings only, which do not imply functional operation of the device at these or any other conditions beyond those indicated under *Recommended Operating Conditions*. Exposure to absolute-maximum-rated conditions for extended periods may affect device reliability.
- See the [V<sub>ISO</sub> Load Recommended Operating Area](#) section for maximum rated values across temperature and V<sub>INP</sub> conditions for each different V<sub>ISO</sub> output mode.

### 6.2 ESD Ratings

			VALUE	UNIT
V <sub>(ESD)</sub>	Electrostatic discharge	Human-body model (HBM), per ANSI/ESDA/JEDEC JS-001 <sup>(1)</sup>	±3000	V
		Charged-device model (CDM), per JEDEC specification JESD22-C101 <sup>(2)</sup>	±1000	

- JEDEC document JEP155 states that 500-V HBM allows safe manufacturing with a standard ESD control process.
- JEDEC document JEP157 states that 250-V CDM allows safe manufacturing with a standard ESD control process.

### 6.3 Recommended Operating Conditions

over operating free-air temperature range (unless otherwise noted)

		MIN	NOM	MAX	UNIT
V <sub>INP</sub>	Primary side supply voltage	4.5	5.0	5.5	V
V <sub>EN</sub>	EN pin input voltage	0		5.5	V
V <sub>SYNC</sub>	SYNC pin input voltage	0		5.5	V
V <sub>SYNC-OK</sub>	SYNC_OK pin drain pin voltage	0		5.5	V
V <sub>ISO</sub>	Isolated power supply voltage	0		5.7	V
V <sub>SEL</sub>	Input voltage	0		5.7	V
f <sub>SYNC</sub>	External DC/DC converter synchronization signal frequency	14.4	16.0	17.6	MHz
P <sub>VISO</sub>	V <sub>ISO</sub> output power at T <sub>a</sub> = 25°C <sup>(1)</sup>			500	mW
T <sub>a</sub>	Ambient temperature	-40		125	°C
T <sub>J</sub>	Junction temperature	-40		150	°C

- See the [V<sub>ISO</sub> Load Recommended Operating Area](#) section for maximum rated values across temperature and V<sub>INP</sub> conditions for each different V<sub>ISO</sub> output mode.

### 6.4 Thermal Information

THERMAL METRIC <sup>(1)</sup>		UCC12051-Q1	UNIT
		DVE (SOIC)	
		16 PINS	
R <sub>θJA</sub>	Junction-to-ambient thermal resistance	57.5	°C/W
R <sub>θJC(top)</sub>	Junction-to-case (top) thermal resistance	21.6	°C/W
R <sub>θJB</sub>	Junction-to-board thermal resistance	33.8	°C/W
ψ <sub>JT</sub>	Junction-to-top characterization parameter	10.2	°C/W
ψ <sub>JB</sub>	Junction-to-board characterization parameter	33.7	°C/W

## 6.4 Thermal Information (continued)

THERMAL METRIC <sup>(1)</sup>		UCC12051-Q1	UNIT
		DVE (SOIC)	
		16 PINS	
R <sub>θJC(bot)</sub>	Junction-to-case (bottom) thermal resistance	—	°C/W

(1) The value of R<sub>θJA</sub> given in this table is only valid for comparison with other packages and can not be used for design purposes. This value was calculated in accordance with JESD 51-7, and simulated on a 4-layer JEDEC board when P<sub>DP</sub> = 129 mW, P<sub>DS</sub> = 142 mW and P<sub>DT</sub> = 129 mW. The board temperature is taken from Pin 12. For more information about traditional and new thermal metrics, see the [Semiconductor and IC Package Thermal Metrics](#) application report.

## 6.5 Power Ratings

V<sub>INP</sub> = 5.0V, C<sub>INP</sub> = C<sub>OUT</sub> = 10 uF, T<sub>J</sub> = 150°C, Internal Clock mode

PARAMETER		TEST CONDITIONS	VALUE	UNIT
P <sub>D</sub>	Power dissipation	SEL connected to GNDS (3.3-V V <sub>ISO</sub> output mode), I <sub>ISO</sub> = 135 mA	460	mW
P <sub>DP</sub>	Power dissipation by driver side (primary)		148	mW
P <sub>DS</sub>	Power dissipation by rectifier side (secondary)		164	mW
P <sub>DT</sub>	Power dissipation by transformer		148	mW

## 6.6 Insulation Specifications

PARAMETER		TEST CONDITIONS	VALUE	UNIT
<b>GENERAL</b>				
CLR	External clearance <sup>(1)</sup>	Shortest terminal-to-terminal distance through air	> 8	mm
CPG	External creepage <sup>(1)</sup>	Shortest terminal-to-terminal distance across the package surface	> 8	mm
DTI	Distance through the insulation	Minimum internal gap (internal clearance)	> 120	µm
CTI	Comparative tracking index	DIN EN 60112 (VDE 0303-11); IEC 60112	> 600	V
	Material group	According to IEC 60664-1	I	
	Overvoltage Category	Rated mains voltage ≤ 300 V <sub>RMS</sub>	I-IV	
		Rated mains voltage ≤ 600 V <sub>RMS</sub>	I-IV	
		Rated mains voltage ≤ 1000 V <sub>RMS</sub>	I-III	
<b>DIN V VDE V 0884-11:2017-01<sup>(2)</sup> (Planned Certification Targets)</b>				
V <sub>IORM</sub>	Maximum repetitive peak isolation voltage	AC voltage (bipolar)	1697	V <sub>PK</sub>
V <sub>IOWM</sub>	Maximum working isolation voltage	AC voltage (sine wave) Time dependent dielectric breakdown (TDDB) test	1200	V <sub>RMS</sub>
		DC voltage	1697	V <sub>DC</sub>
V <sub>IOTM</sub>	Maximum transient isolation voltage	V <sub>TEST</sub> = V <sub>IOTM</sub> , t = 60s (qualification); V <sub>TEST</sub> = 1.2 × V <sub>IOTM</sub> , t = 1s (100% production)	7071	V <sub>PK</sub>
V <sub>IOSM</sub>	Maximum surge isolation voltage <sup>(3)</sup>	Test method per IEC 62368-1, 1.2/50 µs waveform, V <sub>TEST</sub> = 1.6 × V <sub>IOSM</sub> = 10000 V <sub>PK</sub> (qualification)	6250	V <sub>PK</sub>
q <sub>pd</sub>	Apparent charge <sup>(4)</sup>	Method a: After I/O safety test subgroup 2/3, V <sub>ini</sub> = V <sub>IOTM</sub> , t <sub>ini</sub> = 60 s; V <sub>pd(m)</sub> = 1.2 × V <sub>IORM</sub> = 1696 V <sub>PK</sub> , t <sub>m</sub> = 10 s	≤ 5	pC
		Method a: After environmental tests subgroup 1, V <sub>ini</sub> = V <sub>IOTM</sub> , t <sub>ini</sub> = 60 s; V <sub>pd(m)</sub> = 1.6 × V <sub>IORM</sub> = 2262 V <sub>PK</sub> , t <sub>m</sub> = 10 s	≤ 5	
		Method b1: At routine test (100% production) and preconditioning (type test) V <sub>ini</sub> = 1.2 × V <sub>IOTM</sub> , t <sub>ini</sub> = 1 s; V <sub>pd(m)</sub> = 1.875 × V <sub>IORM</sub> = 2651 V <sub>PK</sub> , t <sub>m</sub> = 1 s	≤ 5	
C <sub>IO</sub>	Barrier capacitance, input to output <sup>(5)</sup>	V <sub>IO</sub> = 0.4 sin (2πft), f = 1 MHz	~3.5	pF
R <sub>IO</sub>	Isolation resistance, input to output <sup>(5)</sup>	V <sub>IO</sub> = 500 V, T <sub>A</sub> = 25°C	> 10 <sup>12</sup>	Ω
		V <sub>IO</sub> = 500 V, 100°C ≤ T <sub>A</sub> ≤ 125°C	> 10 <sup>11</sup>	
		V <sub>IO</sub> = 500 V at T <sub>S</sub> = 150°C	> 10 <sup>9</sup>	
	Pollution degree		2	
	Climatic category		40/125/21	

## 6.6 Insulation Specifications (continued)

PARAMETER		TEST CONDITIONS	VALUE	UNIT
<b>UL 1577 (Planned Certification Target)</b>				
$V_{ISO}$	Withstand isolation voltage	$V_{TEST} = V_{ISO} = 5000 V_{RMS}$ , $t = 60$ s (qualification); $V_{TEST} = 1.2 \times V_{ISO} = 6000 V_{RMS}$ , $t = 1$ s (100% production)	5000	$V_{RMS}$

- Creepage and clearance requirements should be applied according to the specific equipment isolation standards of an application. Care should be taken to maintain the creepage and clearance distance of a board design to ensure that the mounting pads of the isolator on the printed-circuit board do not reduce this distance. Creepage and clearance on a printed-circuit board become equal in certain cases. Techniques such as inserting grooves and/or ribs on a printed circuit board are used to help increase these specifications.
- This coupler is suitable for *safe electrical insulation* only within the maximum operating ratings. Compliance with the safety ratings shall be ensured by means of suitable protective circuits.
- Testing is carried out in air or oil to determine the intrinsic surge immunity of the isolation barrier.
- Apparent charge is electrical discharge caused by a partial discharge (pd).
- All pins on each side of the barrier tied together creating a two-terminal device

## 6.7 Safety-Related Certifications

VDE	UL	UL	CQC
Plan to certify according to DIN V VDE V 0884-11:2017-01	Plan to certify according to IEC 60950-1 and IEC 62368-1	Plan to certify under UL 1577 Component Recognition Program	Plan to certify according to GB4943.1-2011
Reinforced insulation Maximum transient isolation voltage, 7071 $V_{PK}$ ; Maximum repetitive peak isolation voltage, 1697 $V_{PK}$ ; Maximum surge isolation voltage, 6250 VPK	Reinforced insulation per UL 60950-1-07+A1+A2, IEC 60950-1 2nd Ed.+A1+A2, UL 62368-1-14 and IEC 62368-1 2nd Ed., 800 $V_{RMS}$ maximum working voltage (pollution degree 2, material group I)	Single protection, 5000 $V_{RMS}$	Reinforced insulation, Altitude $\leq 5000$ m, Tropical Climate, 700 $V_{RMS}$ maximum working voltage
Certificate number: (planned)	Master contract number: (planned)	File number: (planned)	Certificate number: (planned)

## 6.8 Safety Limiting Values

Safety limiting intends to minimize potential damage to the isolation barrier upon failure of input or output circuitry.

PARAMETER		TEST CONDITIONS	MAX	UNIT
$I_S$	Safety input current <sup>(1)</sup>	$R_{\theta JA} = 57.5^\circ\text{C/W}$ , $V_I = 5.5$ V, $T_J = 150^\circ\text{C}$ , $T_A = 25^\circ\text{C}$	395	mA
		$R_{\theta JA} = 57.5^\circ\text{C/W}$ , $V_I = 4.5$ V, $T_J = 150^\circ\text{C}$ , $T_A = 25^\circ\text{C}$	483	
$P_S$	Safety input power	$R_{\theta JA} = 57.5^\circ\text{C/W}$ , $T_J = 150^\circ\text{C}$ , $T_A = 25^\circ\text{C}$	2174	mW
$T_S$	Safety temperature <sup>(1)</sup>		150	$^\circ\text{C}$

- The maximum safety temperature,  $T_S$ , has the same value as the maximum junction temperature,  $T_J$ , specified for the device. The  $I_S$  and  $P_S$  parameters represent the safety current and safety power respectively. The maximum limits of  $I_S$  and  $P_S$  should not be exceeded. These limits vary with the ambient temperature,  $T_A$ . The junction-to-air thermal resistance,  $R_{\theta JA}$ , in the [Thermal Information](#) table is that of a device installed on a high-K test board for leaded surface-mount packages. Use these equations to calculate the value for each parameter:  $T_J = T_A + R_{\theta JA} \times P$ , where P is the power dissipated in the device.  $T_{J(max)} = T_S = T_A + R_{\theta JA} \times P_S$ , where  $T_{J(max)}$  is the maximum allowed junction temperature.  $P_S = I_S \times V_I$ , where  $V_I$  is the maximum input voltage.

## 6.9 Electrical Characteristics

Over operating temperature range ( $T_J = -40^{\circ}\text{C}$  to  $150^{\circ}\text{C}$ ),  $V_{\text{INP}} = 4.5\text{V}$  to  $5.5\text{V}$ ,  $C_{\text{INP}} = C_{\text{OUT}} = 10\ \mu\text{F}$ , internal clock mode, unless otherwise noted. All typical values at  $T_A = 25^{\circ}\text{C}$  and  $V_{\text{INP}} = 5.0\text{V}$ .

	PARAMETER	TEST CONDITIONS	MIN	TYP	MAX	UNIT
<b>INPUT SUPPLY</b>						
$I_{\text{VINQ}}$	VINP quiescent current, disabled	EN=LOW			100	$\mu\text{A}$
$I_{\text{VINO}}$	VINP operating current, no load	EN=HI; SEL shorted to VISO (5.0V output)		52	80	mA
		EN=HI; SEL 100k $\Omega$ to VISO (5.4V output)		48	70	
		EN=HI; SEL shorted to GNDS (3.3V output)		96	140	
		EN=HI; SEL 100k $\Omega$ to GNDS (3.7V output)		82	120	
$I_{\text{VIN\_SC}}$	DC current from VINP supply under short circuit on VISO	VISO short to GNDS		245		mA
$V_{\text{UVPR}}$	VINP under-voltage lockout rising threshold			4.25	4.45	V
$V_{\text{UVPF}}$	VINP under-voltage lockout falling threshold		3.5	3.75		V
$V_{\text{UVPH}}$	VINP under-voltage lockout hysteresis			0.5		V
<b>EN, SYNC INPUT PINS</b>						
$V_{\text{IR}}$	Input voltage threshold, logic HIGH	Rising edge			2.2	V
$V_{\text{IF}}$	Input voltage threshold, logic LOW	Falling edge	0.8			V
$I_{\text{EN}}$	Enable Pin Input Current	$V_{\text{EN}} = 5.0\ \text{V}$		5	10	$\mu\text{A}$
$I_{\text{SYNC}}$	SYNC Pin Input Current	$V_{\text{SYNC}} = 5.0\ \text{V}$		0.02	1	$\mu\text{A}$
<b>SYNC_OK PIN</b>						
$V_{\text{OL}}$	SYNC_OK output low voltage	$I_{\text{SYNC\_OK}} = -2\ \text{mA}$		0.15		V
$I_{\text{LKG\_SYNC\_OK}}$	SYNC_OK pin leakage current	$V_{\text{SYNC\_OK}} = 5.0\ \text{V}$			1	$\mu\text{A}$
<b>DC/DC CONVERTER</b>						
$V_{\text{ISO}}$	Isolated supply output voltage	SEL shorted to VISO (5.0V output); $I_{\text{ISO}} = 55\ \text{mA}$ <sup>(3)</sup>	4.8	5	5.2	V
		SEL 100k $\Omega$ to VISO (5.4 V output); $I_{\text{ISO}} = 45\ \text{mA}$ <sup>(3)</sup>	5.18	5.4	5.62	V
		SEL shorted to GNDS (3.3V output); $I_{\text{ISO}} = 100\ \text{mA}$ <sup>(3)</sup>	3.17	3.3	3.43	V
		SEL 100k $\Omega$ to GNDS (3.7 V output); $I_{\text{ISO}} = 90\ \text{mA}$ <sup>(3)</sup>	3.55	3.7	3.85	V
$V_{\text{ISO(RIP)}}$	Voltage ripple on isolated supply output (pk-pk) <sup>(1)</sup>	20-MHz bandwidth, CLOAD = 10 $\mu\text{F}$    0.1 $\mu\text{F}$ , SEL shorted to VISO (5.0V output); $I_{\text{ISO}} = 100\ \text{mA}$		50		mV
		20-MHz bandwidth, CLOAD = 10 $\mu\text{F}$    0.1 $\mu\text{F}$ , SEL 100k $\Omega$ to VISO (5.4V output); $I_{\text{ISO}} = 90\ \text{mA}$		50		mV
		20-MHz bandwidth, CLOAD = 10 $\mu\text{F}$    0.1 $\mu\text{F}$ , SEL shorted to GNDS (3.3V output); $I_{\text{ISO}} = 145\ \text{mA}$		50		mV
		20-MHz bandwidth, CLOAD = 10 $\mu\text{F}$    0.1 $\mu\text{F}$ , SEL shorted to GNDS (3.7V output); $I_{\text{ISO}} = 130\ \text{mA}$		50		mV
$V_{\text{ISO(LINE)}}$	$V_{\text{ISO}}$ DC line regulation	SEL shorted to VISO (5.0 V output); $I_{\text{ISO}} = 55\ \text{mA}$ , $V_{\text{INP}} = 4.5\ \text{V}$ to $5.5\ \text{V}$			1%	
		SEL shorted to GNDS (3.3 V output); $I_{\text{ISO}} = 100\ \text{mA}$ , $V_{\text{INP}} = 4.5\ \text{V}$ to $5.5\ \text{V}$			1%	

## 6.9 Electrical Characteristics (continued)

Over operating temperature range ( $T_J = -40^{\circ}\text{C}$  to  $150^{\circ}\text{C}$ ),  $V_{\text{INP}} = 4.5\text{V}$  to  $5.5\text{V}$ ,  $C_{\text{INP}} = C_{\text{OUT}} = 10\ \mu\text{F}$ , internal clock mode, unless otherwise noted. All typical values at  $T_A = 25^{\circ}\text{C}$  and  $V_{\text{INP}} = 5.0\text{V}$ .

	PARAMETER	TEST CONDITIONS	MIN	TYP	MAX	UNIT
$V_{\text{ISO(Load)}}$	$V_{\text{ISO}}$ DC load regulation	SEL shorted to VISO (5.0 V output); $I_{\text{ISO}} = 0$ to 100 mA		1.5%		
		SEL shorted to GNDS (3.3 V output); $I_{\text{ISO}} = 0$ to 145 mA		1.5%		
EFF	Efficiency at maximum recommended load <sup>(2)</sup>	SEL shorted to VISO (5.0 V output); $I_{\text{ISO}} = 100$ mA		60%		
		SEL 100k $\Omega$ to VISO (5.4V output); $I_{\text{ISO}} = 90$ mA		60%		
		SEL shorted to GNDS (3.3V output); $I_{\text{ISO}} = 145$ mA		50%		
		SEL 100k $\Omega$ to GNDS (3.7V output); $I_{\text{ISO}} = 130$ mA		53%		
$t_{\text{RISE}}$	VISO rise time, 10% - 90%	EN = change from LO to HI, SEL shorted to VISO (5.0V output); $I_{\text{ISO}} = 1$ mA		750	1000	$\mu\text{s}$
		EN = change from LO to HI, SEL 100k $\Omega$ to GNDS (3.3V output); $I_{\text{ISO}} = 1$ mA		300	500	$\mu\text{s}$
<b>THERMAL SHUTDOWN</b>						
$\text{TSD}_{\text{THR}}$	Thermal shutdown threshold <sup>(1)</sup>	Junction Temperature, Rising		165		$^{\circ}\text{C}$
$\text{TSD}_{\text{HYST}}$	Thermal shutdown hysteresis <sup>(1)</sup>	Junction Temperature, Falling		27		$^{\circ}\text{C}$

(1) Not tested in production. Ensured by characterization.

(2) Efficiency calculation:  $\text{EFF} = (V_{\text{ISO}} \times I_{\text{ISO}}) / (V_{\text{INP}} \times I_{\text{INP}})$

(3) See the [VISO Load Recommended Operating Area](#) section for discussion of  $V_{\text{ISO}}$  regulation across load and temperature conditions for all output voltage settings.

## 6.10 Switching Characteristics

Over operating temperature range ( $T_J = -40^{\circ}\text{C}$  to  $150^{\circ}\text{C}$ ),  $V_{\text{INP}} = 4.5\text{V}$  to  $5.5\text{V}$ ,  $C_{\text{INP}} = C_{\text{OUT}} = 10\ \mu\text{F}$ , internal clock mode, unless otherwise noted. All typical values at  $T_A = 25^{\circ}\text{C}$  and  $V_{\text{INP}} = 5.0\text{V}$ .

	PARAMETER	TEST CONDITIONS	MIN	TYP	MAX	UNIT
$f_{\text{SW\_INT}}$	DC/DC Converter Clock	Internal clock mode		8		MHz
CMTI	Static common-mode transient immunity <sup>(1)</sup>	Slew Rate of GNPD versus GNDS, $V_{\text{CM}} = 1000\ \text{V}$	100			V/ns

(1) Not tested in production. Ensured by characterization.



### 6.11 Insulation Characteristics Curves

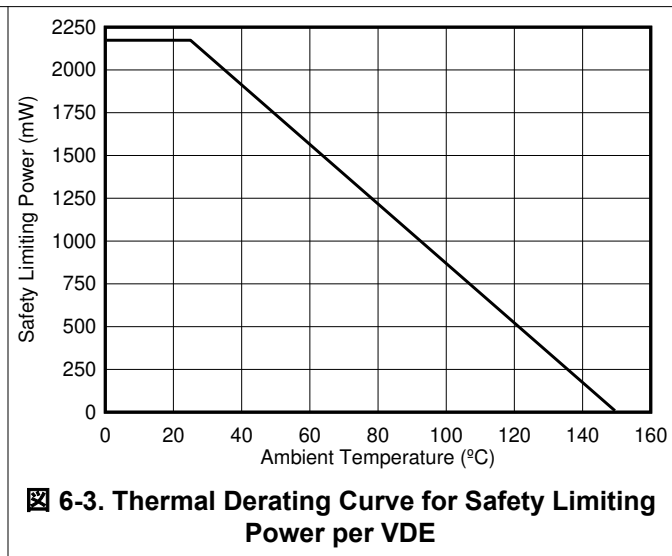
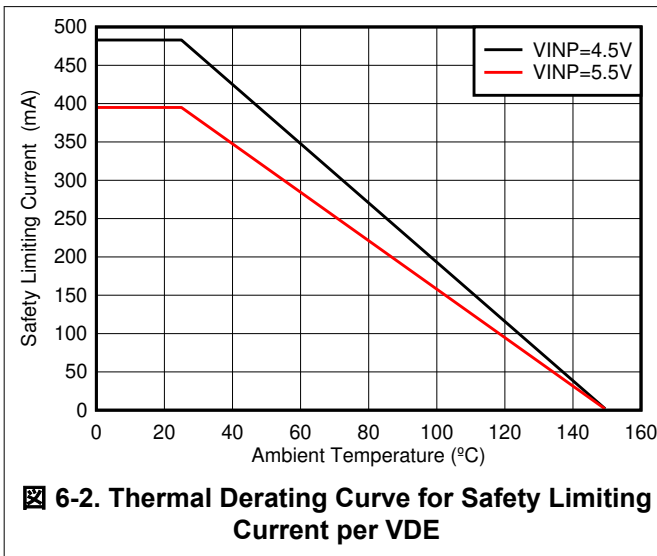
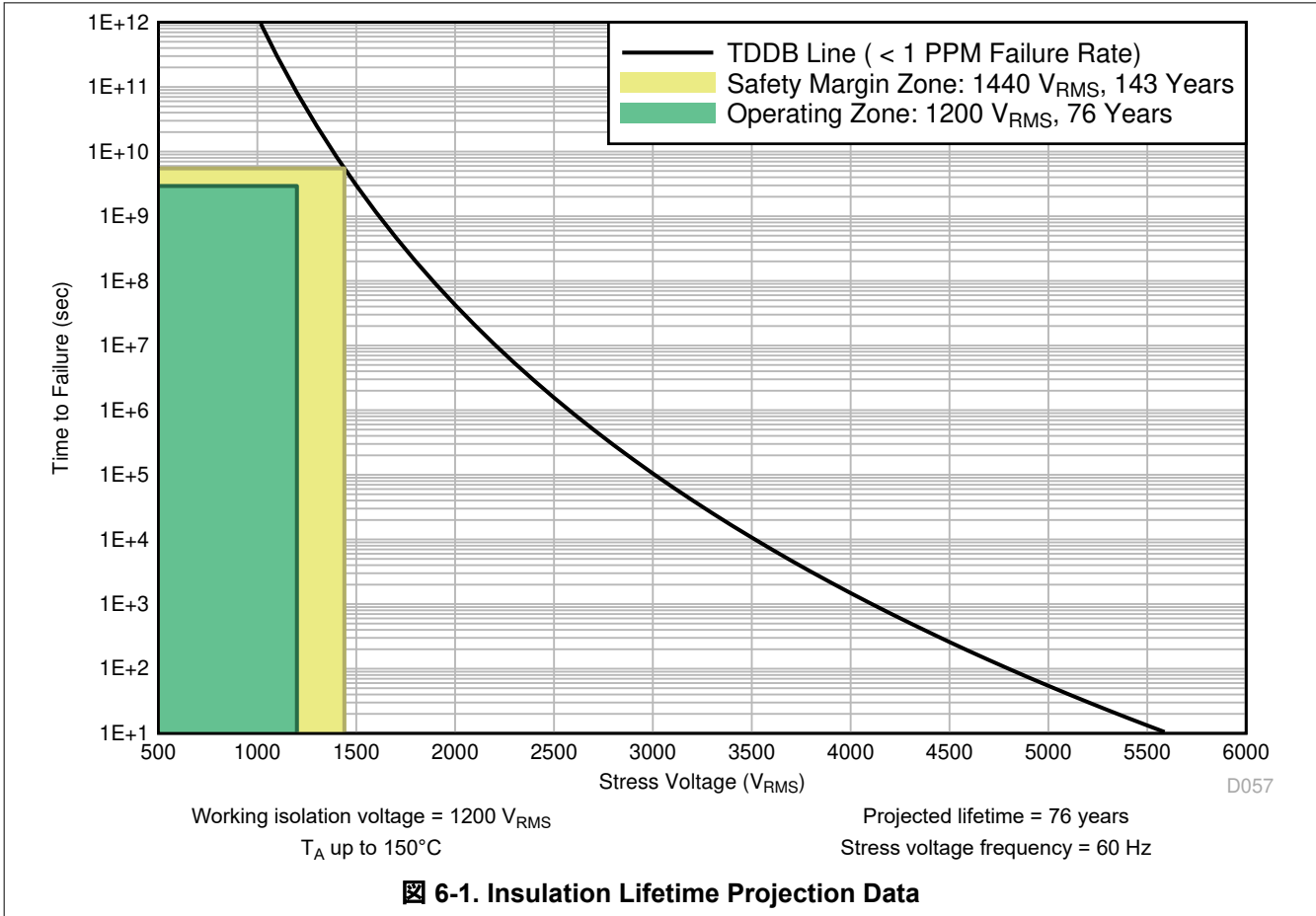

## 6.12 Typical Characteristics

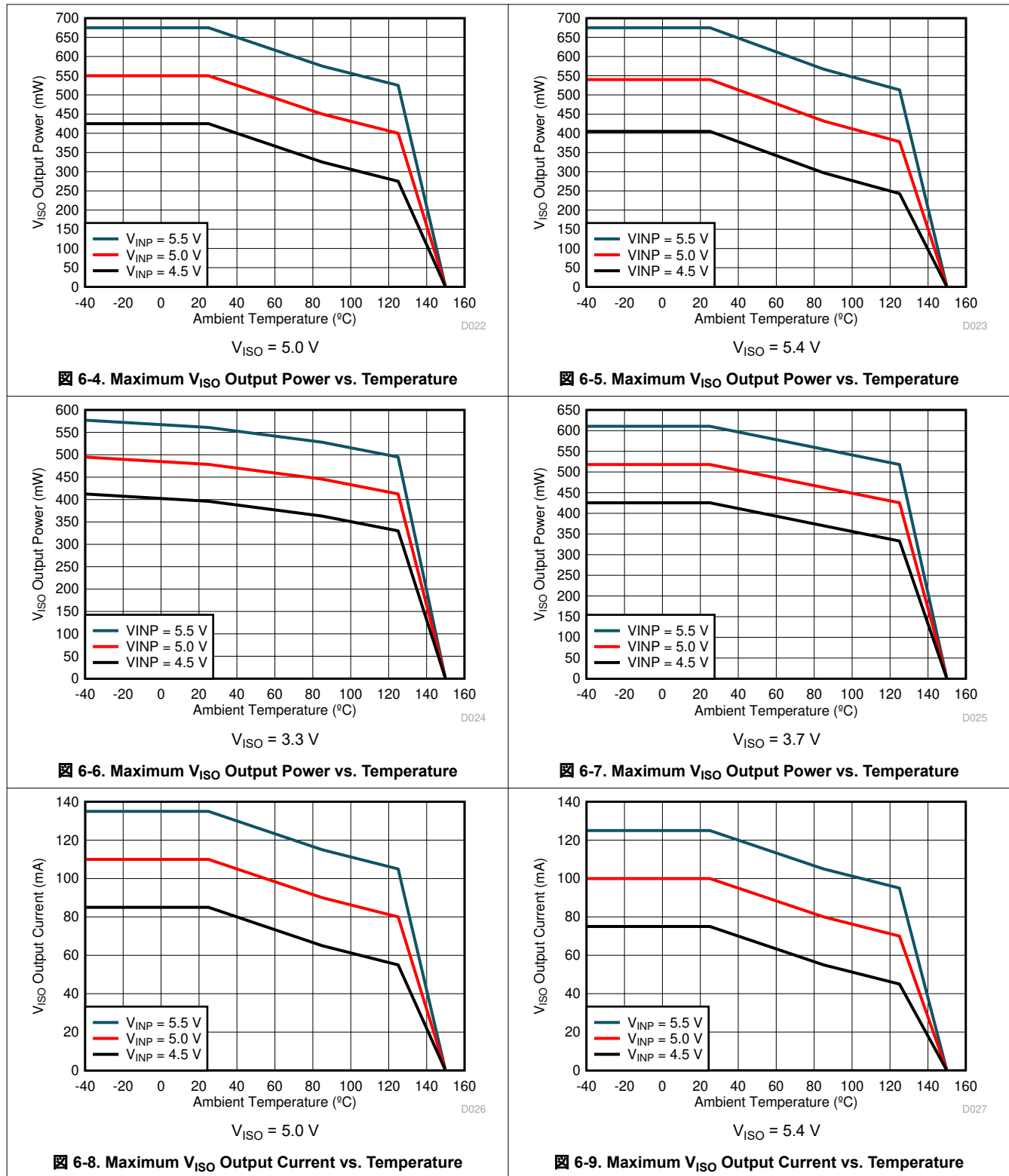

### 6.12 Typical Characteristics (continued)

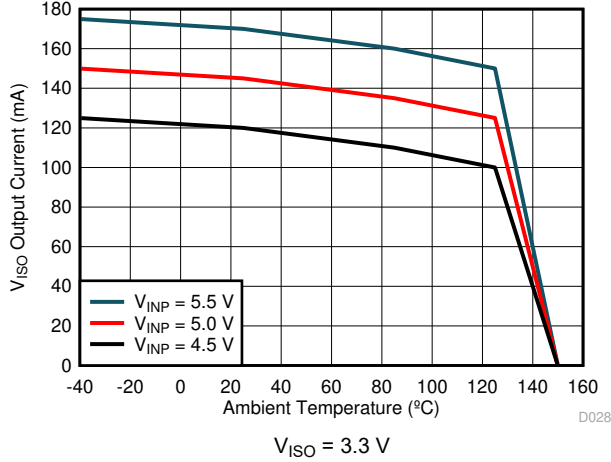

6-10. Maximum  $V_{ISO}$  Output Current vs. Temperature

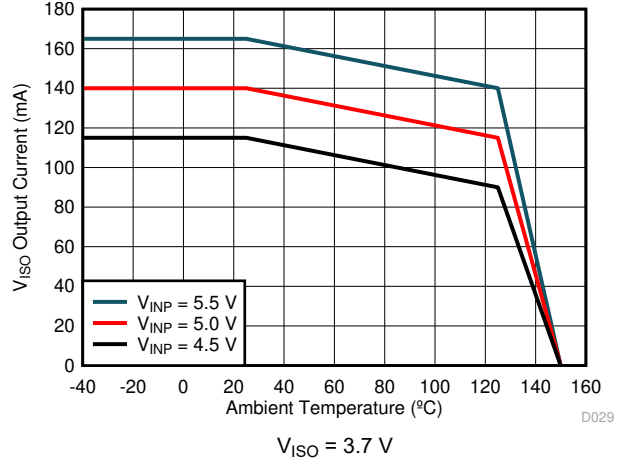

6-11. Maximum  $V_{ISO}$  Output Current vs. Temperature

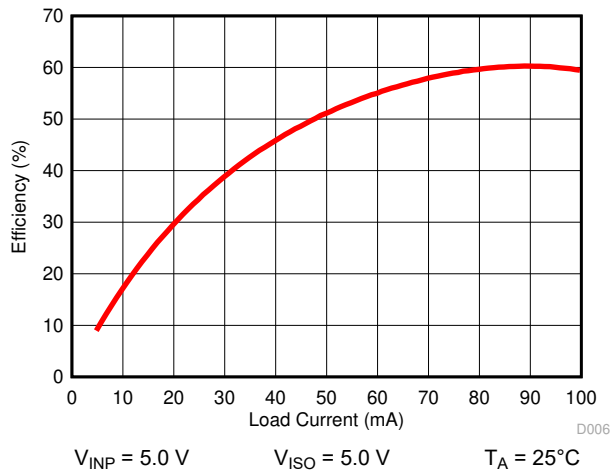

6-12. Power Supply Efficiency vs Load Current ( $I_{ISO}$ )

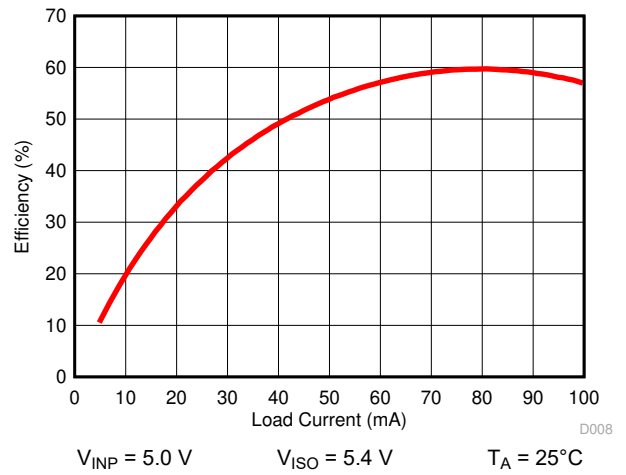

6-13. Power Supply Efficiency vs Load Current ( $I_{ISO}$ )

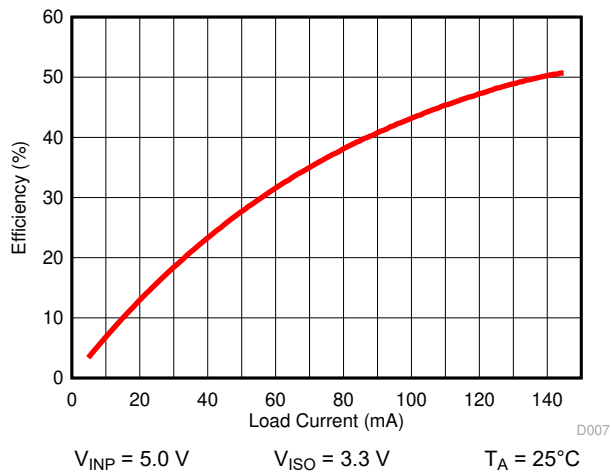

6-14. Power Supply Efficiency vs Load Current ( $I_{ISO}$ )

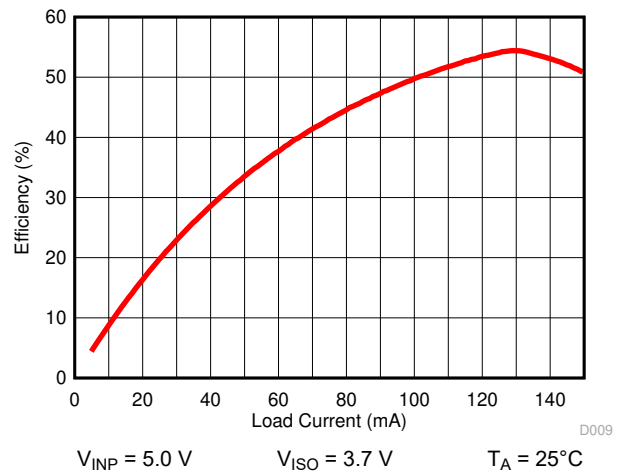

6-15. Power Supply Efficiency vs Load Current ( $I_{ISO}$ )

### 6.12 Typical Characteristics (continued)

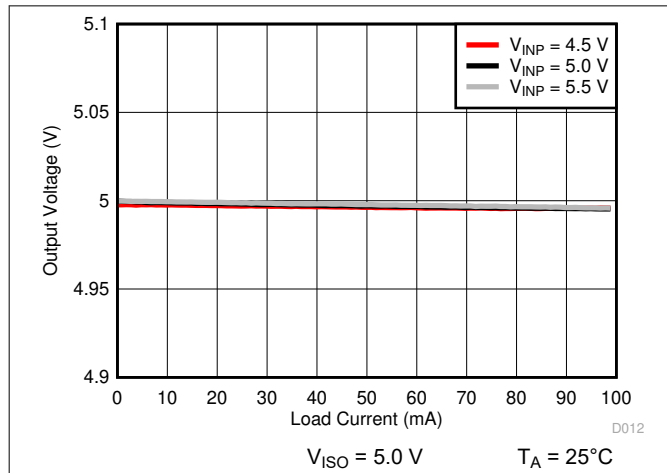

6-16. Isolated Supply Voltage ( $V_{ISO}$ ) vs Load Current ( $I_{ISO}$ )

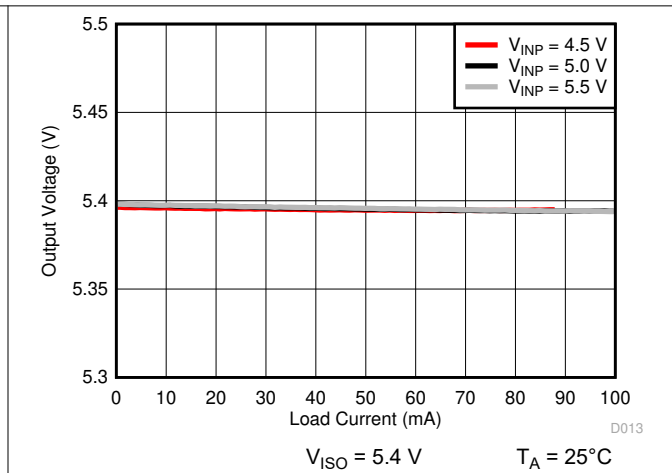

6-17. Isolated Supply Voltage ( $V_{ISO}$ ) vs Load Current ( $I_{ISO}$ )

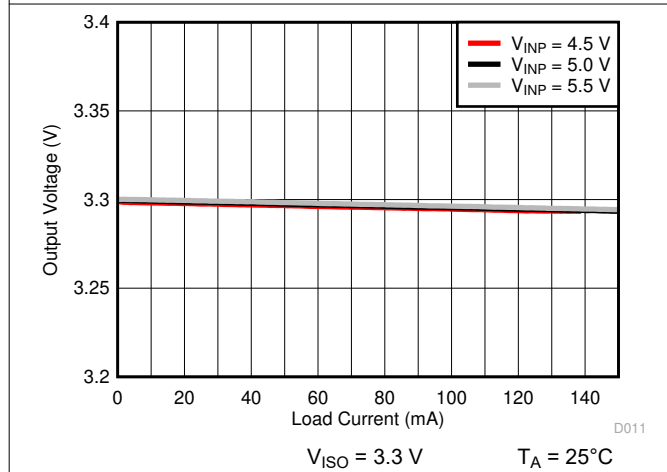

6-18. Isolated Supply Voltage ( $V_{ISO}$ ) vs Load Current ( $I_{ISO}$ )

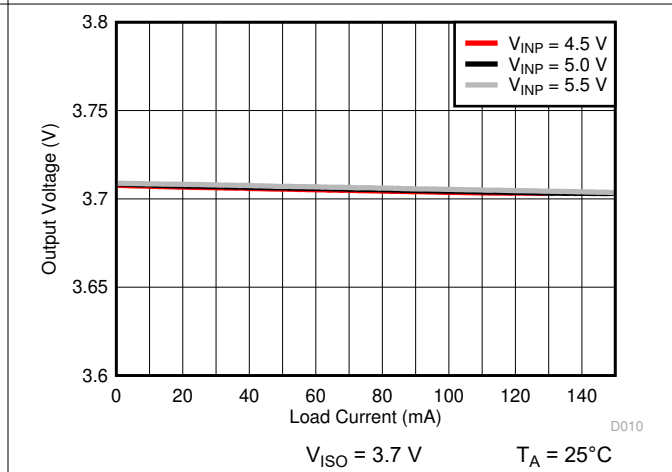

6-19. Isolated Supply Voltage ( $V_{ISO}$ ) vs Load Current ( $I_{ISO}$ )

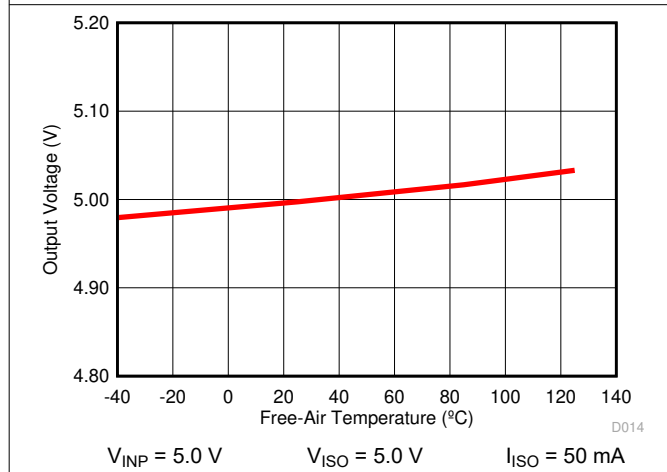

6-20. Isolated Supply Voltage ( $V_{ISO}$ ) vs Free-Air Temperature

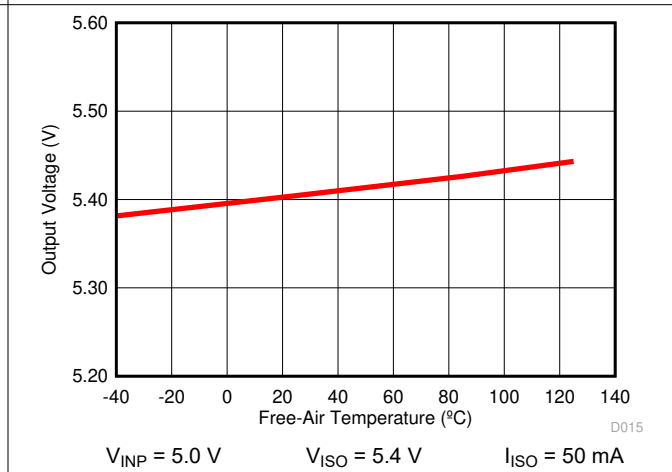

6-21. Isolated Supply Voltage ( $V_{ISO}$ ) vs Free-Air Temperature

### 6.12 Typical Characteristics (continued)

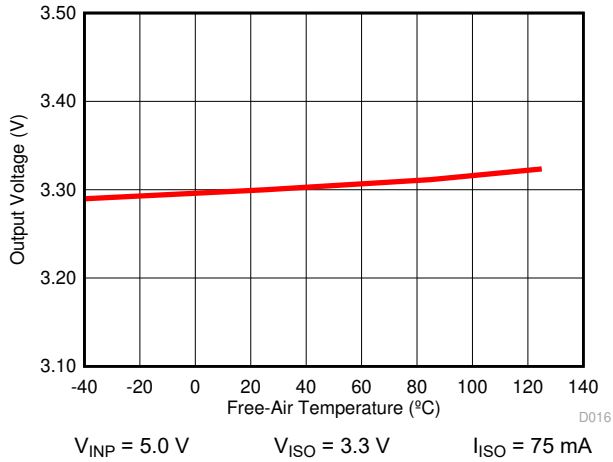

6-22. Isolated Supply Voltage ( $V_{ISO}$ ) vs Free-Air Temperature

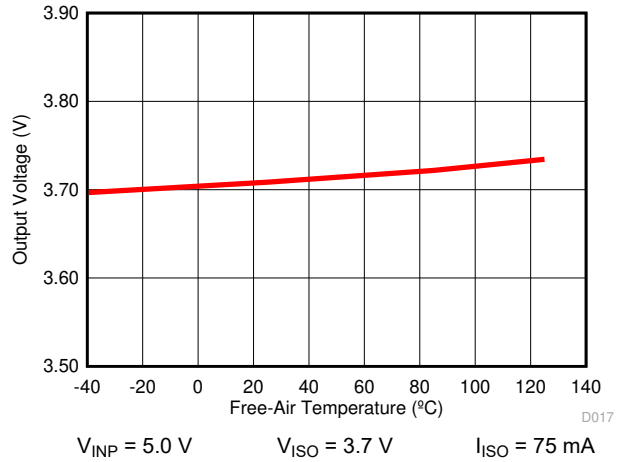

6-23. Isolated Supply Voltage ( $V_{ISO}$ ) vs Free-Air Temperature

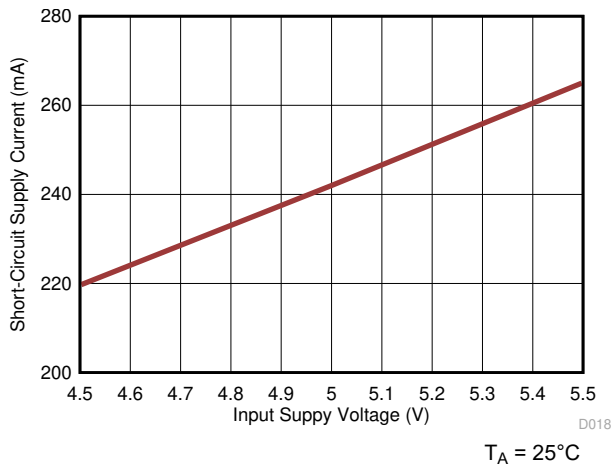

6-24. Short-Circuit Supply Current ( $I_{VIN\_SC}$ ) vs Supply Voltage ( $V_{INP}$ )

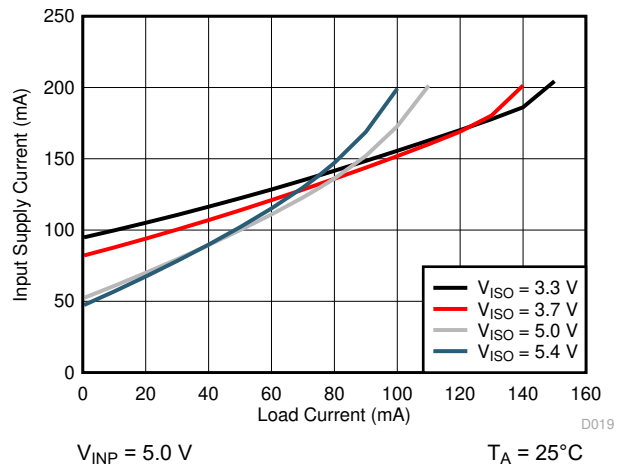

6-25. Input Supply Current ( $I_{VINP}$ ) vs Load Current ( $I_{ISO}$ )

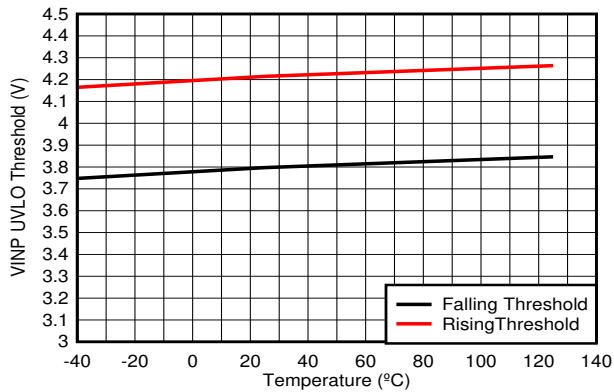

6-26. Typical  $V_{INP}$  UVLO Threshold vs Junction Temperature ( $T_J$ )

## 7 Detailed Description

### 7.1 Overview

The UCC12051-Q1 device integrates a high-efficiency, low-emissions isolated DC/DC converter. This approach provides typically 500 mW of clean, steady power across a 5000- $V_{RMS}$  isolation barrier.

The integrated DC/DC converter uses switched mode operation and proprietary circuit techniques to reduce power losses and boost efficiency. Specialized control mechanisms, clocking schemes, and the use of an on-chip transformer provide high efficiency and low radiated emissions.

The VINP supply is provided to the primary power controller that switches the power stage connected to the integrated transformer. Power is transferred to the secondary side, rectified, and regulated to a level set by the SEL pin condition.

A fast feedback control loop monitors VISO and the output load, and ensures low overshoots and undershoots during load transients. Undervoltage lockout (UVLO) with hysteresis is integrated on the VINP supply, which ensures robust system performance under noisy conditions.

UCC12051-Q1 is suitable for applications that have limited board space and require more integration. These devices are also suitable for very-high voltage applications, where power transformers meeting the required isolation specifications are bulky and expensive.

### 7.2 Functional Block Diagram

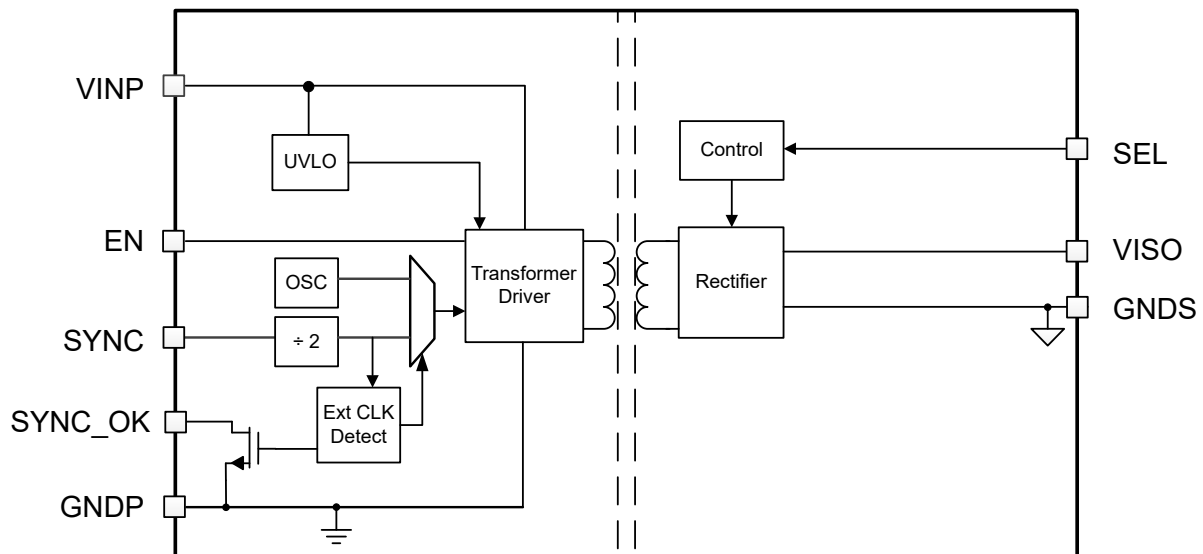

### 7.3 Feature Description

#### 7.3.1 Enable and Disable

Forcing EN low disables the device, which greatly reduces the VINP power consumption. Pull the EN pin high to enable normal device functionality. The EN pin has a weak internal pull-down resistor, so the device floats to the disable state if the pin is left open.

#### 7.3.2 UVLO, Power-Up, and Power-Down Behavior

The UCC12051-Q1 has an undervoltage lockout (UVLO) on the VINP power supply. Upon power-up, while the VINP voltage is below the threshold voltage  $V_{UVPR}$ , the primary side transformer driver is disabled, and VISO output is off. The output powers up once the threshold is met. Likewise, if VINP falls below  $V_{UVPF}$ , the converter is disabled and there is no output at VISO. Both UVLO threshold voltages have hysteresis to avoid chattering.

### 7.3.3 V<sub>ISO</sub> Load Recommended Operating Area

Figure 7-1 depicts the device V<sub>ISO</sub> regulation behavior across the output load range, including when the output is overloaded. For proper device operation, ensure that the device V<sub>ISO</sub> output load does not exceed the maximum output current (I<sub>OUT\_MAX</sub>). The value for I<sub>OUT\_MAX</sub> over different temperature and V<sub>INP</sub> conditions are shown from Figure 6-8 to Figure 6-11. The following protection mechanisms will be engaged if the UCC12051-Q1 is loaded beyond the recommended operating area:

1. The device limits the maximum output power. If a load exceeding I<sub>OUT\_MAX</sub> is applied, V<sub>ISO</sub> drops accordingly to meet the maximum power limit.
2. If V<sub>ISO</sub> drops below nominal 3.8 V while operating in the constant power limit region, the over-power fold-back feature will switch the power converter from active rectification to passive rectification, and the built-in recovery hysteresis will ensure the UCC12051-Q1 recovers at a lower output power. The device returns to active rectification when load drops and V<sub>ISO</sub> increases above nominal 4.3 V.
3. The device triggers a soft-start reset if V<sub>ISO</sub> drops below the nominal 1.8-V threshold. This reset is designed to protect the device during V<sub>ISO</sub> short-circuit conditions.
4. Thermal shutdown protection disables the converter if the device is operated in any of the above regions long enough to raise the silicon junction temperature above the thermal shutdown threshold. See the Section 7.3.4 for more details on this device feature.

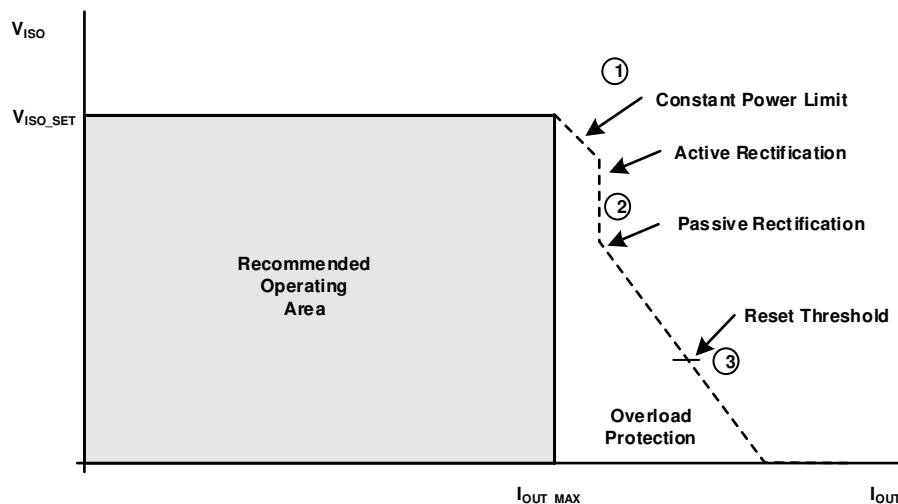

Figure 7-1. V<sub>ISO</sub> Load Recommended Operating Area Description

### 7.3.4 Thermal Shutdown

Thermal protection is also integrated to help prevent the device from getting damaged during overload and short-circuit conditions on the isolated output. Under these conditions, the device temperature starts to increase. When the silicon junction temperature T<sub>j</sub> sensed at the primary side die goes above the threshold TSD<sub>THR</sub> (typical 165°C), thermal shutdown activates and the primary controller turns off which removes the energy supplied to the V<sub>ISO</sub> load, which causes the device to cool off. When the junction temperature drops approximately 27°C (TSD<sub>HYST</sub>) from the shutdown point, the device starts to function normally. If an overload or output short-circuit condition prevails, this protection cycle is repeated. Make sure the design prevents the device junction temperatures from reaching such high values.

### 7.3.5 External Clocking and Synchronization

The UCC12051-Q1 has an internal oscillator trimmed to drive the transformer at 8.0 MHz. An external clock may be applied at the SYNC pin to override the internal oscillator. This external clock will be divided by 2, so the target range for the external clock signal at SYNC is 16 MHz ±10%. When a valid external clock signal is detected, the internal spread spectrum modulation (SSM) algorithm is disabled. This allows an external clock signal with a unique SSM to be applied. The depth and frequency of SSM is a tradeoff versus low frequency modulated V<sub>ISO</sub> voltage ripple. The SYNC\_OK pin is asserted LOW if there is no external SYNC clock or one

that is outside of the operating range of the device is detected. In this state, the external clock is ignored and the DC/DC converter is clocked by the internal oscillator. The pin is in high-impedance if a valid clock is applied on SYNC.

### 7.3.6 $V_{ISO}$ Output Voltage Selection

The SEL pin is monitored during power-up — within the first 1 ms after applying VINP above the UVLO rising threshold or enabling via the EN pin — to detect the desired regulation voltage for the VISO output. Note that after this initial monitoring, the SEL pin no longer affects the VISO output level. In order to change the output mode selection, either the EN pin must be toggled or the VINP power supply must be cycled off and back on. Section 6.4 provides more details on the SEL pin functionality.

### 7.3.7 Electromagnetic Compatibility (EMC) Considerations

UCC12051-Q1 devices use spread spectrum modulation algorithm for the internal oscillator and advanced internal layout scheme to minimize radiated emissions at the system level.

Many applications in harsh environment are sensitive to disturbances such as electrostatic discharge (ESD), electrical fast transient (EFT), surge and electromagnetic emissions. These electromagnetic disturbances are regulated by international standards such as CISPR 25. Although system-level performance and reliability depends, to a large extent, on the application board design and layout, the device incorporates many chip-level design improvements for overall system robustness.

## 7.4 Device Functional Modes

表 7-1 lists the supply functional modes for this device.

**表 7-1. Device Functional Modes**

INPUTS		Isolated Supply Output Voltage ( $V_{ISO}$ ) Setpoint
EN	SEL	
HIGH	Shorted to VISO	5.0 V
HIGH	100 k $\Omega$ to VISO	5.4 V
HIGH	Shorted to GNDS	3.3 V
HIGH	100 k $\Omega$ to GNDS	3.7 V
HIGH	OPEN <sup>(1)</sup>	UNSUPPORTED
LOW	X	0 V

(1) The SEL pin has an internal weak pull-down resistance to ground, but leaving this pin open is not recommended.



## 8 Application and Implementation

注

Information in the following applications sections is not part of the TI component specification, and TI does not warrant its accuracy or completeness. TI's customers are responsible for determining suitability of components for their purposes. Customers should validate and test their design implementation to confirm system functionality.

### 8.1 Application Information

The UCC12051-Q1 device is suitable for applications that have limited board space and desire more integration. This device is also suitable for very high voltage applications, where power transformers meeting the required isolation specifications are bulky and expensive.

### 8.2 Typical Application

Figure 8-1 shows the typical application schematic for the UCC12051-Q1 device supplying an isolated load.



图 8-1. Typical Application

#### 8.2.1 Design Requirements

To design using UCC12051-Q1, a few simple design considerations must be evaluated. Table 8-1 shows some recommended values for a typical application. See [Power Supply Recommendations](#) and [Layout](#) sections to review other key design considerations for the UCC12051-Q1.

表 8-1. Design Parameters

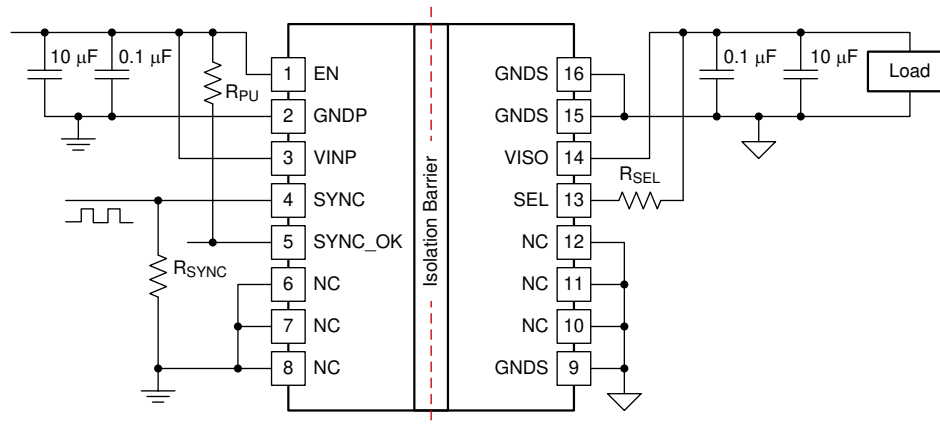
PARAMETER	RECOMMENDED VALUE
Input supply voltage, $V_{INP}$	4.5 V to 5.5 V
Decoupling capacitance between $V_{INP}$ and GNDP	10 µF, 16 V, ± 10%, X7R
Decoupling capacitance between $V_{ISO}$ and GNDS <sup>(1)</sup>	10 µF, 16 V, ± 10%, X7R
Optional additional capacitance on $V_{ISO}$ or $V_{INP}$ to reduce high-frequency ripple	0.1 µF, 50 V, ± 10%, X7R
Pull-up resistor from SYNC_OK to $V_{INP}$ , $R_{PU}$	100 kΩ
Pull-up resistor from SEL to $V_{ISO}$ for 5.0-V output voltage mode, $R_{SEL}$	0 Ω
Pull-up resistor from SEL to $V_{ISO}$ for 5.4-V output voltage mode, $R_{SEL}$	100 kΩ
Optional SYNC signal impedance-matching resistor, $R_{SYNC}$	Match source — typical values are 50 Ω, 75 Ω, 100 Ω, or 1 kΩ
External clock signal applied on SYNC	16 MHz

(1) See [VISO Output Capacitor Selection](#) section.

## 8.2.2 Detailed Design Procedure

Place ceramic decoupling capacitors as close as possible to the device pins. For the input supply, place the capacitor(s) between pin 3 (VINP) and pin 2 (GNDP). For the isolated output supply, place the capacitor(s) between pin 14 (VISO) and pin 15 (GNDS). This location is of particular importance to the input decoupling capacitor, because this capacitor supplies the transient current associated with the fast switching waveforms of the power drive circuits. The recommended capacitor value is 10  $\mu\text{F}$ . Ensure the capacitor dielectric material is compatible with the target application temperature.

### 8.2.2.1 VISO Output Capacitor Selection

The UCC12051-Q1 is optimized to run with an effective output capacitance of 5  $\mu\text{F}$  to 20  $\mu\text{F}$ . A ceramic capacitor is recommended. Ceramic capacitors have DC-Bias and temperature derating effects, which both have influence the final effective capacitance. Choose the right capacitor carefully in combination with considering its package size, dielectric and voltage rating. It is good design practice to include one 0.1- $\mu\text{F}$  capacitor close to the device for high-frequency noise reduction.

### 8.2.3 Application Curves

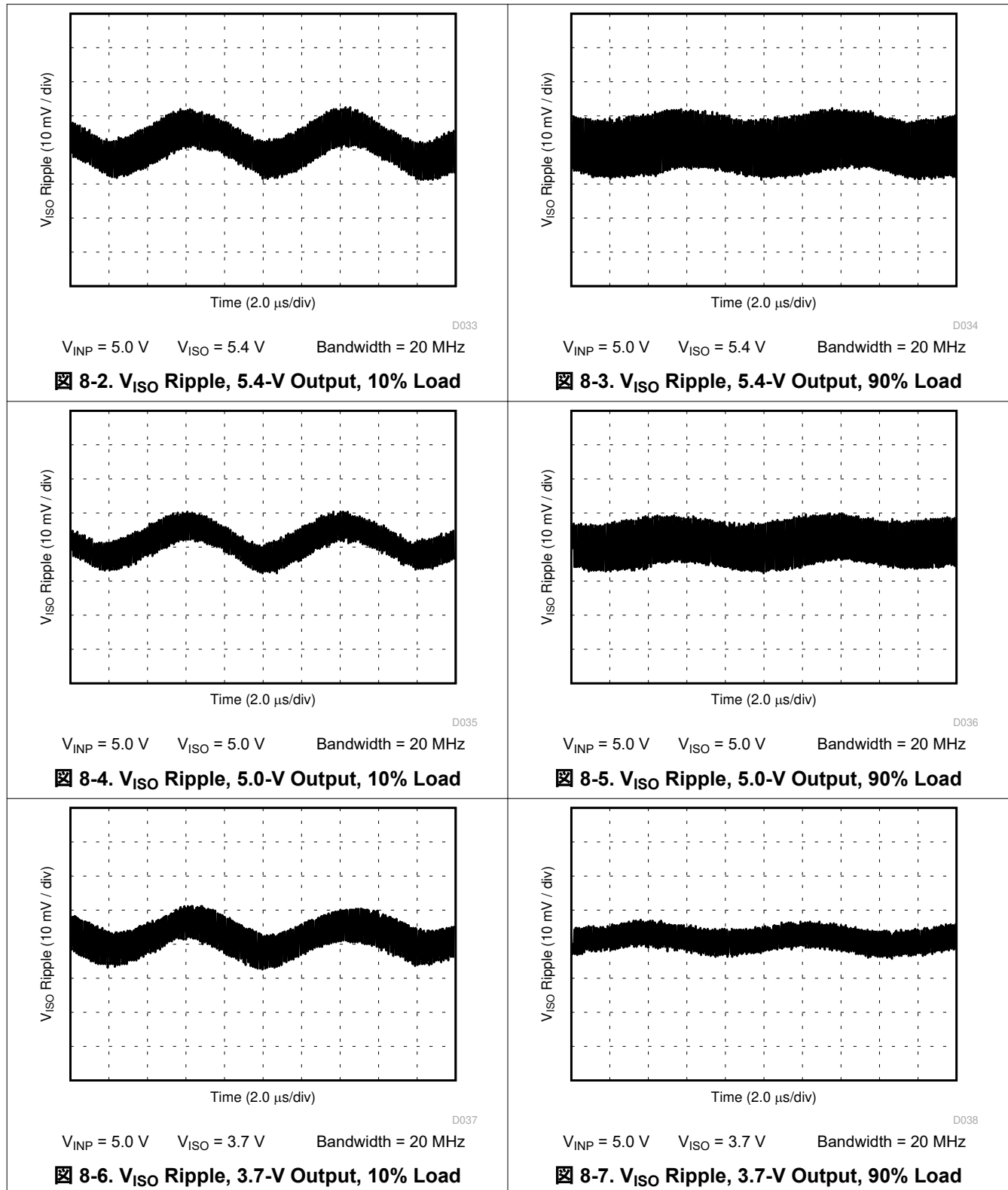

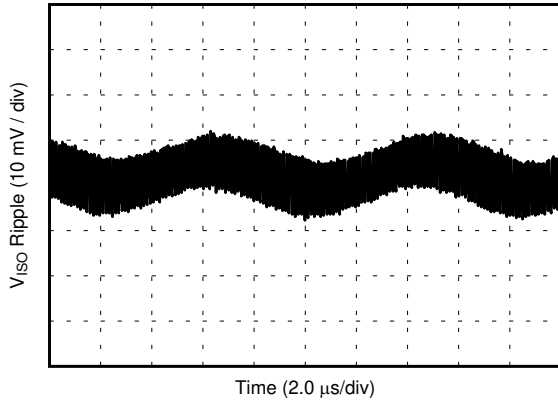

D039

$V_{INP} = 5.0\text{ V}$     $V_{ISO} = 3.3\text{ V}$    Bandwidth = 20 MHz

**8-8.  $V_{ISO}$  Ripple, 3.3-V Output, 10% Load**

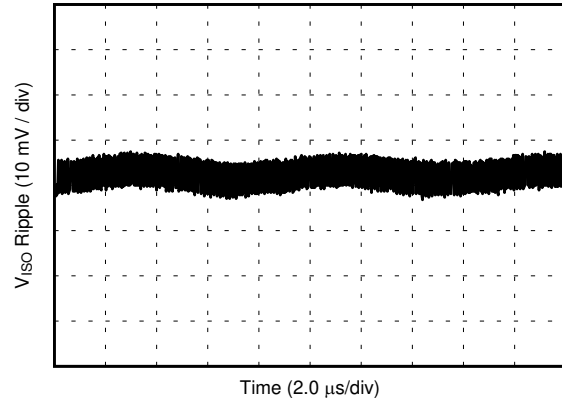

D040

$V_{INP} = 5.0\text{ V}$     $V_{ISO} = 3.3\text{ V}$    Bandwidth = 20 MHz

**8-9.  $V_{ISO}$  Ripple, 3.3-V Output, 90% Load**

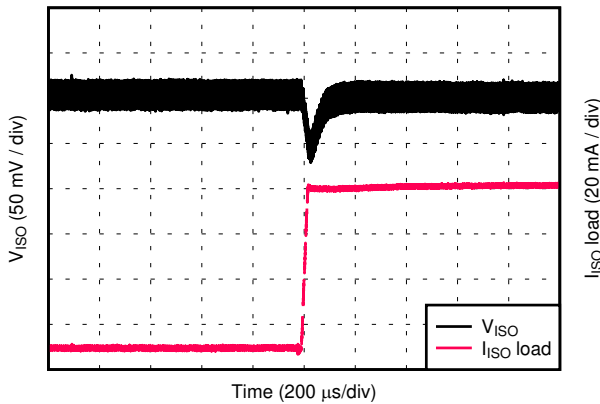

D041

**8-10.  $V_{ISO}$  Load Transient Response, 10% to 90% Load Step, 5.0-V Input, 5.4-V Output**

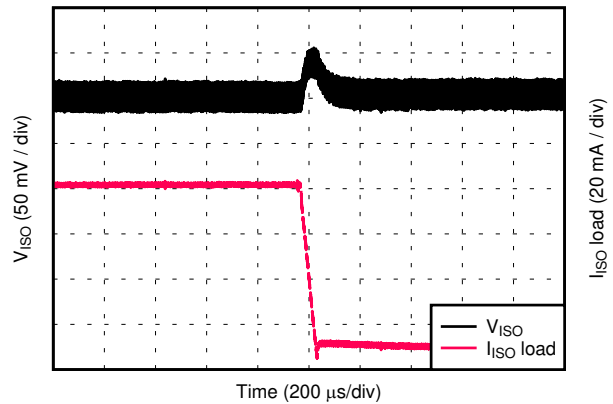

D042

**8-11.  $V_{ISO}$  Load Transient Response, 90% to 10% Load Step, 5.0-V Input, 5.4-V Output**

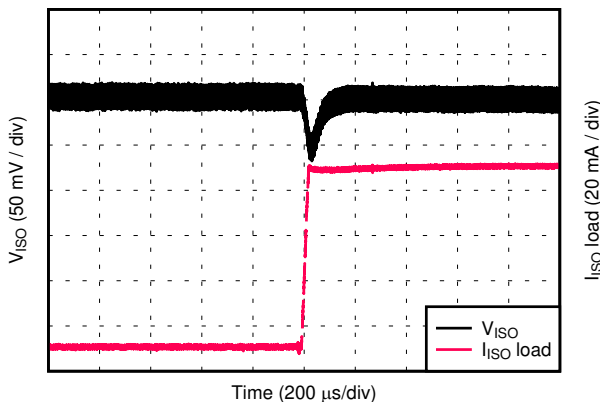

D043

**8-12.  $V_{ISO}$  Load Transient Response, 10% to 90% Load Step, 5.0-V Input, 5.0-V Output**

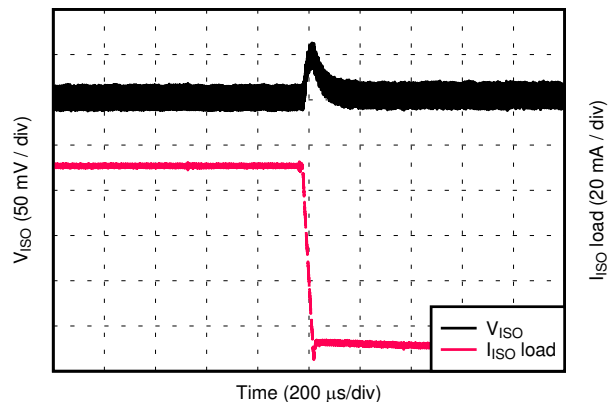

D044

**8-13.  $V_{ISO}$  Load Transient Response, 90% to 10% Load Step, 5.0-V Input, 5.0-V Output**

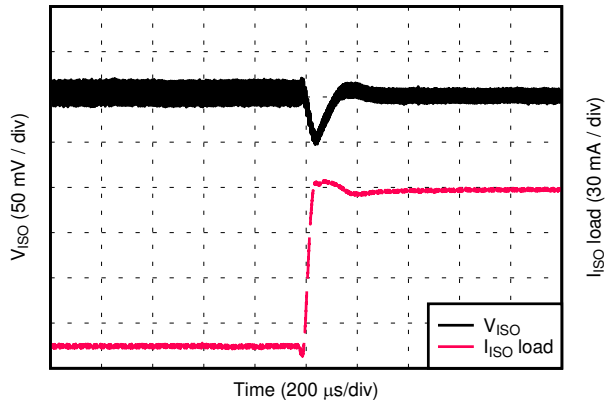

**8-14.  $V_{ISO}$  Load Transient Response, 10% to 90% Load Step, 5.0-V Input, 3.7-V Output**

D045

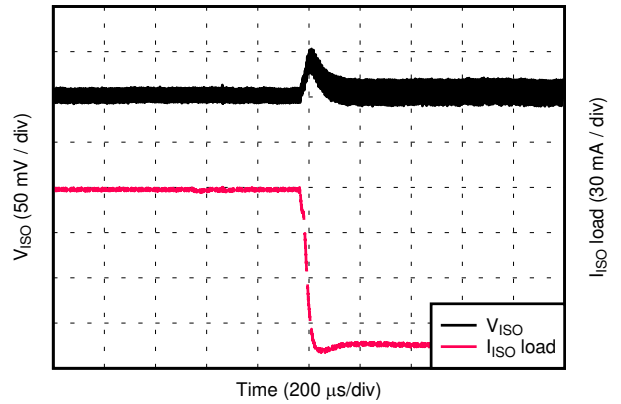

**8-15.  $V_{ISO}$  Load Transient Response, 90% to 10% Load Step, 5.0-V Input, 3.7-V Output**

D046

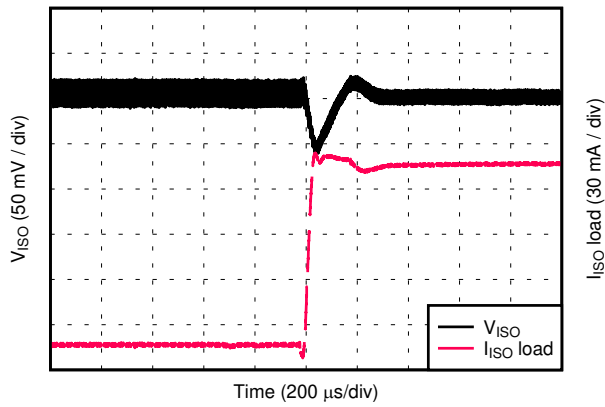

**8-16.  $V_{ISO}$  Load Transient Response, 10% to 90% Load Step, 5.0-V Input, 3.3-V Output**

D047

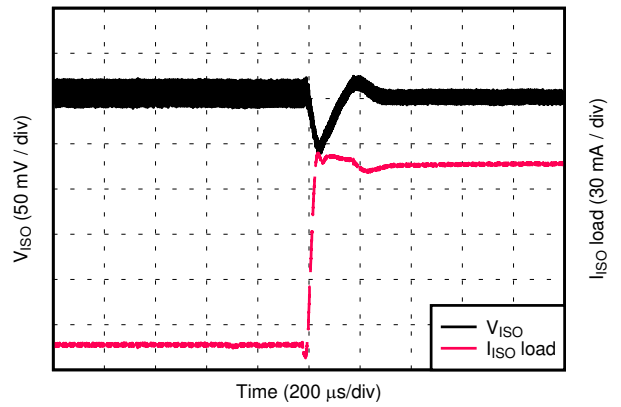

**8-17.  $V_{ISO}$  Load Transient Response, 90% to 10% Load Step, 5.0-V Input, 3.3-V Output**

D047

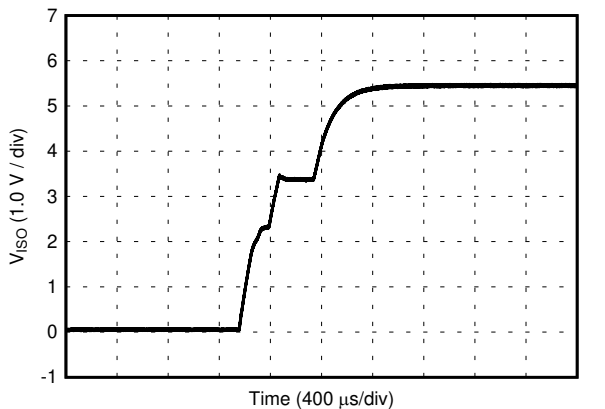

**8-18.  $V_{ISO}$  Soft Start at 10% Rated Load, 5.0-V Input, 5.4-V Output**

D049

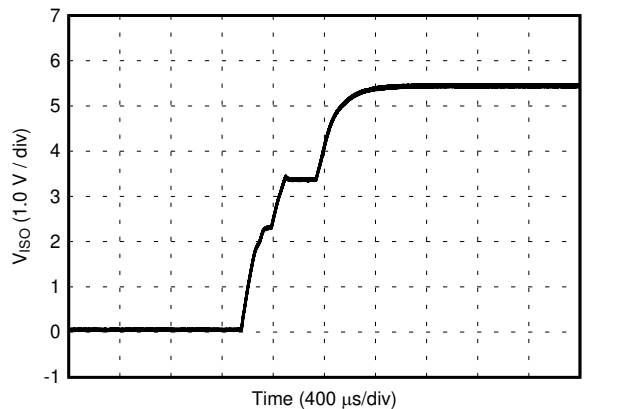

**8-19.  $V_{ISO}$  Soft Start at 90% Rated Load, 5.0-V Input, 5.4-V Output**

D050

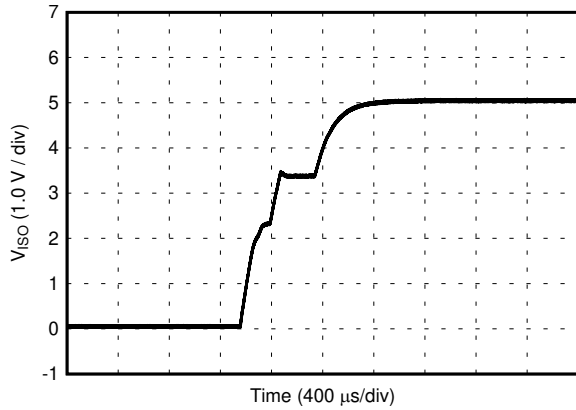

D051

**8-20.  $V_{ISO}$  Soft Start at 10% Rated Load, 5.0-V Input, 5.0-V Output**

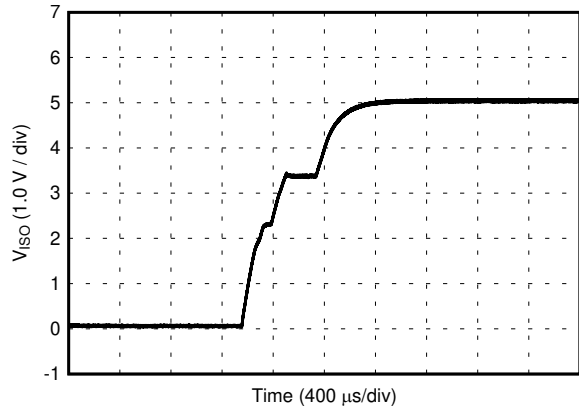

D052

**8-21.  $V_{ISO}$  Soft Start at 90% Rated Load, 5.0-V Input, 5.0-V Output**

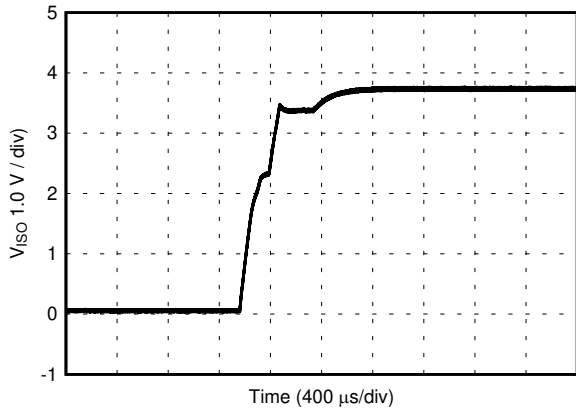

D053

**8-22.  $V_{ISO}$  Soft Start at 10% Rated Load, 5.0-V Input, 3.7-V Output**

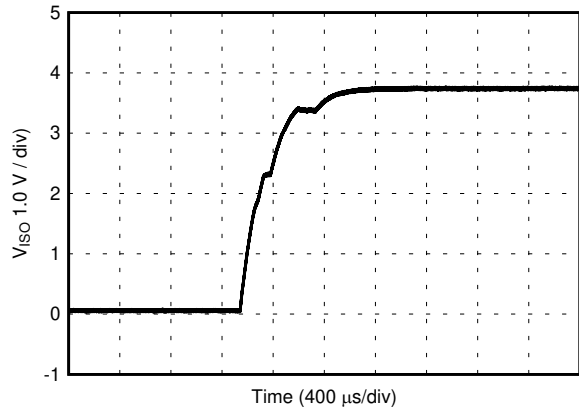

D054

**8-23.  $V_{ISO}$  Soft Start at 90% Rated Load, 5.0-V Input, 3.7-V Output**

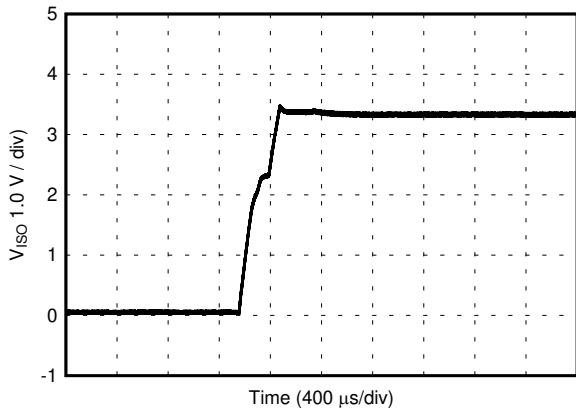

D055

**8-24.  $V_{ISO}$  Soft Start at 10% Rated Load, 5.0-V Input, 3.3-V Output**

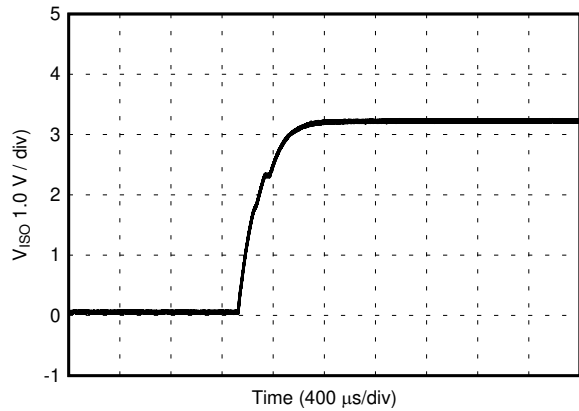

D056

**8-25.  $V_{ISO}$  Soft Start at 90% Rated Load, 5.0-V Input, 3.3-V Output**

## 9 Power Supply Recommendations

The recommended input supply voltage (VINP) for the UCC12051-Q1 is between 4.5 V and 5.5 V. To help ensure reliable operation, adequate decoupling capacitors must be located as close to supply pins as possible. Place local bypass capacitors between the VINP and GNDP pins at the input, and between VISO and GNDS at the isolated output supply. Low ESR, ceramic surface mount capacitors are recommended. It is further suggested that one place two such capacitors: one with a value of 10  $\mu$ F for supply bypassing, and an additional 100-nF capacitor in parallel for high frequency filtering. The input supply must have an appropriate current rating to support output load required by the end application.

## 10 Layout

### 10.1 Layout Guidelines

The UCC12051-Q1 integrated isolated power solution simplifies system design and reduces board area usage. Proper PCB layout is important in order to achieve optimum performance. Here is a list of recommendations:

1. Place decoupling capacitors as close as possible to the device pins. For the input supply, place the capacitor(s) between pin 3 (VINP) and pin 2 (GNDP). For the isolated output supply, place the capacitor(s) between pin 14 (VISO) and pin 15 (GNDS). This location is of particular importance to the input decoupling capacitor, because this capacitor supplies the transient current associated with the fast switching waveforms of the power drive circuits.
2. Because the device does not have a thermal pad for heat-sinking, the device dissipates heat through the respective GND pins. Ensure that enough copper (preferably a connection to the ground plane) is present on all GNDP and GNDS pins for best heat-sinking.
3. If space and layer count allow, it is also recommended to connect the VINP, GNDP, VISO and GNDS pins to internal ground or power planes through multiple vias of adequate size. Alternatively, make traces for these nets as wide as possible to minimize losses.
4. TI also recommends grounding the no-connect pins (NC) to their respective ground planes. For pins 6, 7, and 8, connect to GNDP. For pins 10, 11, and 12, connect to GNDS. This will allow more continuous ground planes and larger thermal mass for heat-sinking.
5. A minimum of four layers is recommended to accomplish a low-EMI PCB design. Inner layers can be spaced closer than outer layers and used to create a high-frequency bypass capacitor between GNDP and GNDS to reduce radiated emissions. Ensure proper spacing, both inter-layer and layer-to-layer, is implemented to avoid reducing isolation capabilities. These spacings will vary based on the printed circuit board construction parameters, such as dielectric material and thickness.
6. Pay close attention to the spacing between primary ground plane (GNDP) and secondary ground plane (GNDS) on the PCB outer layers. The effective creepage and or clearance of the system will be reduced if the two ground planes have a lower spacing than that of the device package.
7. To ensure isolation performance between the primary and secondary side, avoid placing any PCB traces or copper below the UCC12051-Q1 device on the outer copper layers.

## 10.2 Layout Example

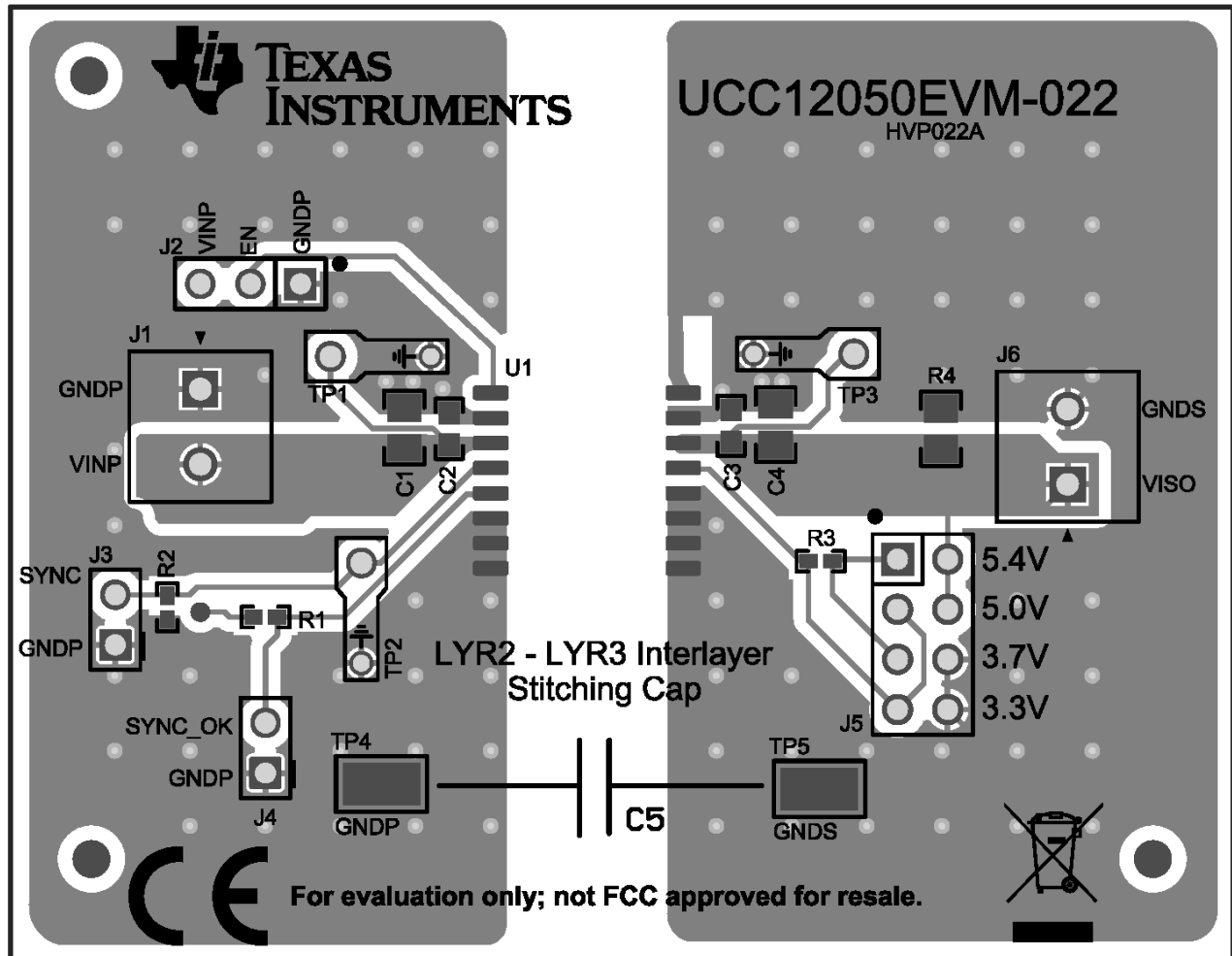

10-1. Layout Example



## 11 Device and Documentation Support

### 11.1 Device Support

#### 11.1.1 Development Support

For development support, refer to:

- [Isolated 5-V bias supply for automotive CISPR 25, class 5 emissions, reference design](#)

### 11.2 Documentation Support

#### 11.2.1 Related Documentation

For related documentation see the following:

- [UCC12050 Evaluation Module User Guide](#)
- [Isolation Glossary](#)

### 11.3 Receiving Notification of Documentation Updates

To receive notification of documentation updates, navigate to the device product folder on [ti.com](#). Click on *Subscribe to updates* to register and receive a weekly digest of any product information that has changed. For change details, review the revision history included in any revised document.

### 11.4 サポート・リソース

TI E2E™ サポート・フォーラムは、エンジニアが検証済みの回答と設計に関するヒントをエキスパートから迅速かつ直接得ることができる場所です。既存の回答を検索したり、独自の質問をしたりすることで、設計に必要な支援を迅速に得ることができます。

リンクされているコンテンツは、該当する貢献者により、現状のまま提供されるものです。これらは TI の仕様を構成するものではなく、必ずしも TI の見解を反映したものではありません。TI の[使用条件](#)を参照してください。

### 11.5 Trademarks

TI E2E™ is a trademark of Texas Instruments.

すべての商標は、それぞれの所有者に帰属します。

### 11.6 Electrostatic Discharge Caution



This integrated circuit can be damaged by ESD. Texas Instruments recommends that all integrated circuits be handled with appropriate precautions. Failure to observe proper handling and installation procedures can cause damage.

ESD damage can range from subtle performance degradation to complete device failure. Precision integrated circuits may be more susceptible to damage because very small parametric changes could cause the device not to meet its published specifications.

### 11.7 Glossary

[TI Glossary](#) This glossary lists and explains terms, acronyms, and definitions.

## 12 Mechanical, Packaging, and Orderable Information

The following pages include mechanical, packaging, and orderable information. This information is the most current data available for the designated devices. This data is subject to change without notice and revision of this document. For browser-based versions of this data sheet, refer to the left-hand navigation.

**PACKAGING INFORMATION**

Orderable Device	Status (1)	Package Type	Package Drawing	Pins	Package Qty	Eco Plan (2)	Lead finish/ Ball material (6)	MSL Peak Temp (3)	Op Temp (°C)	Device Marking (4/5)	Samples
UCC12051QDVERQ1	ACTIVE	SO-MOD	DVE	16	2000	RoHS & Green	NIPDAU	Level-3-260C-168 HR	-40 to 125	UCC12051Q1	Samples

(1) The marketing status values are defined as follows:

**ACTIVE:** Product device recommended for new designs.

**LIFEBUY:** TI has announced that the device will be discontinued, and a lifetime-buy period is in effect.

**NRND:** Not recommended for new designs. Device is in production to support existing customers, but TI does not recommend using this part in a new design.

**PREVIEW:** Device has been announced but is not in production. Samples may or may not be available.

**OBSELETE:** TI has discontinued the production of the device.

(2) **RoHS:** TI defines "RoHS" to mean semiconductor products that are compliant with the current EU RoHS requirements for all 10 RoHS substances, including the requirement that RoHS substance do not exceed 0.1% by weight in homogeneous materials. Where designed to be soldered at high temperatures, "RoHS" products are suitable for use in specified lead-free processes. TI may reference these types of products as "Pb-Free".

**RoHS Exempt:** TI defines "RoHS Exempt" to mean products that contain lead but are compliant with EU RoHS pursuant to a specific EU RoHS exemption.

**Green:** TI defines "Green" to mean the content of Chlorine (Cl) and Bromine (Br) based flame retardants meet JS709B low halogen requirements of <=1000ppm threshold. Antimony trioxide based flame retardants must also meet the <=1000ppm threshold requirement.

(3) MSL, Peak Temp. - The Moisture Sensitivity Level rating according to the JEDEC industry standard classifications, and peak solder temperature.

(4) There may be additional marking, which relates to the logo, the lot trace code information, or the environmental category on the device.

(5) Multiple Device Markings will be inside parentheses. Only one Device Marking contained in parentheses and separated by a "-" will appear on a device. If a line is indented then it is a continuation of the previous line and the two combined represent the entire Device Marking for that device.

(6) Lead finish/Ball material - Orderable Devices may have multiple material finish options. Finish options are separated by a vertical ruled line. Lead finish/Ball material values may wrap to two lines if the finish value exceeds the maximum column width.

**Important Information and Disclaimer:**The information provided on this page represents TI's knowledge and belief as of the date that it is provided. TI bases its knowledge and belief on information provided by third parties, and makes no representation or warranty as to the accuracy of such information. Efforts are underway to better integrate information from third parties. TI has taken and continues to take reasonable steps to provide representative and accurate information but may not have conducted destructive testing or chemical analysis on incoming materials and chemicals. TI and TI suppliers consider certain information to be proprietary, and thus CAS numbers and other limited information may not be available for release.

In no event shall TI's liability arising out of such information exceed the total purchase price of the TI part(s) at issue in this document sold by TI to Customer on an annual basis.

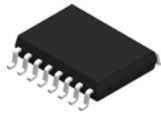

# PACKAGE OUTLINE

## DVE0016A

### SO-MOD - 2.65 mm max height

SMALL OUTLINE INTEGRATED CIRCUIT

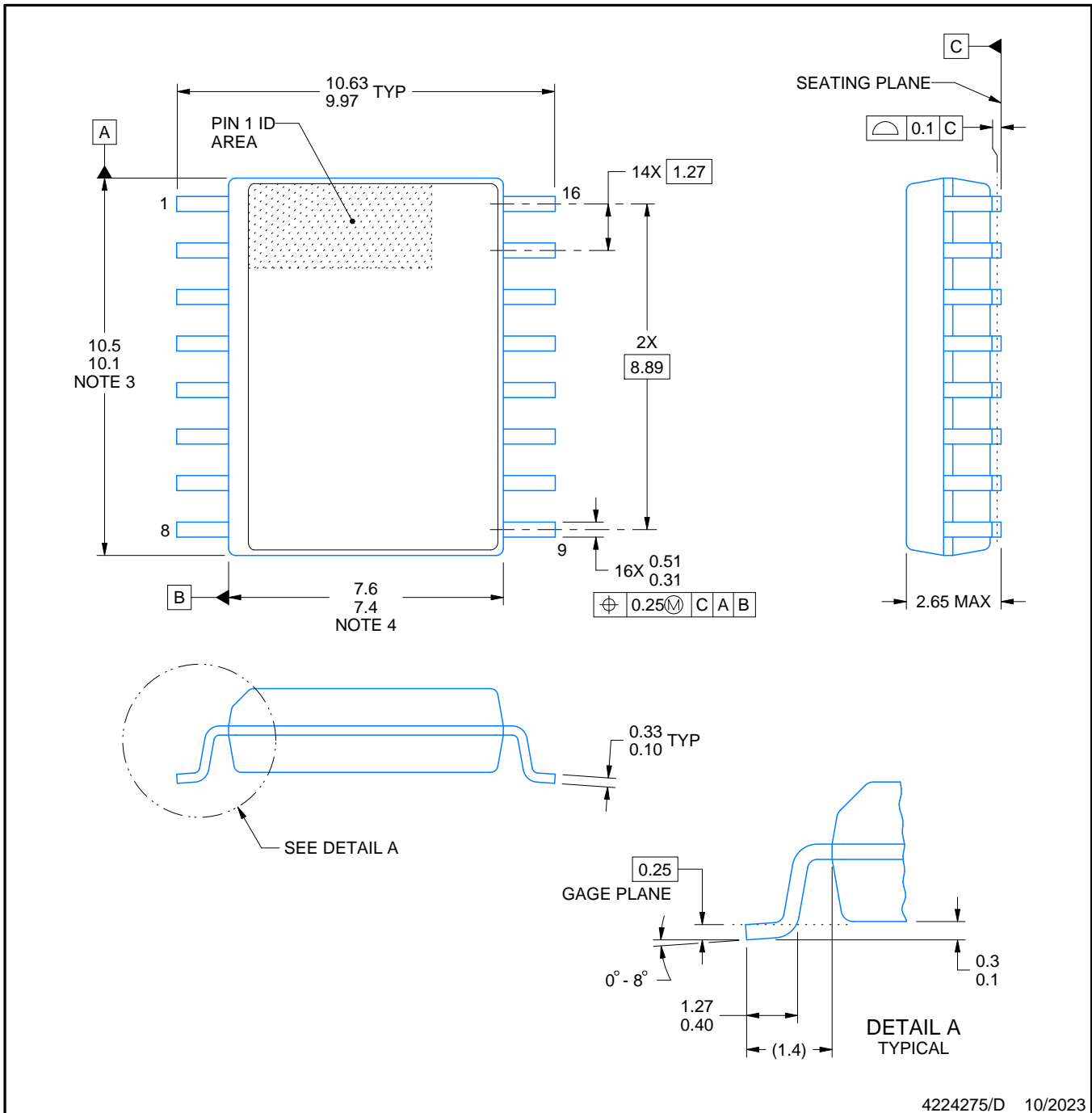

4224275/D 10/2023

#### NOTES:

1. All linear dimensions are in millimeters. Any dimensions in parenthesis are for reference only. Dimensioning and tolerancing per ASME Y14.5M.
2. This drawing is subject to change without notice.
3. This dimension does not include mold flash, protrusions, or gate burrs. Mold flash, protrusions, or gate burrs shall not exceed 0.15 mm, per side.
4. This dimension does not include interlead flash. Interlead flash shall not exceed 0.25 mm, per side.
5. Reference JEDEC registration MS-013.

# EXAMPLE BOARD LAYOUT

DVE0016A

SO-MOD - 2.65 mm max height

SMALL OUTLINE INTEGRATED CIRCUIT

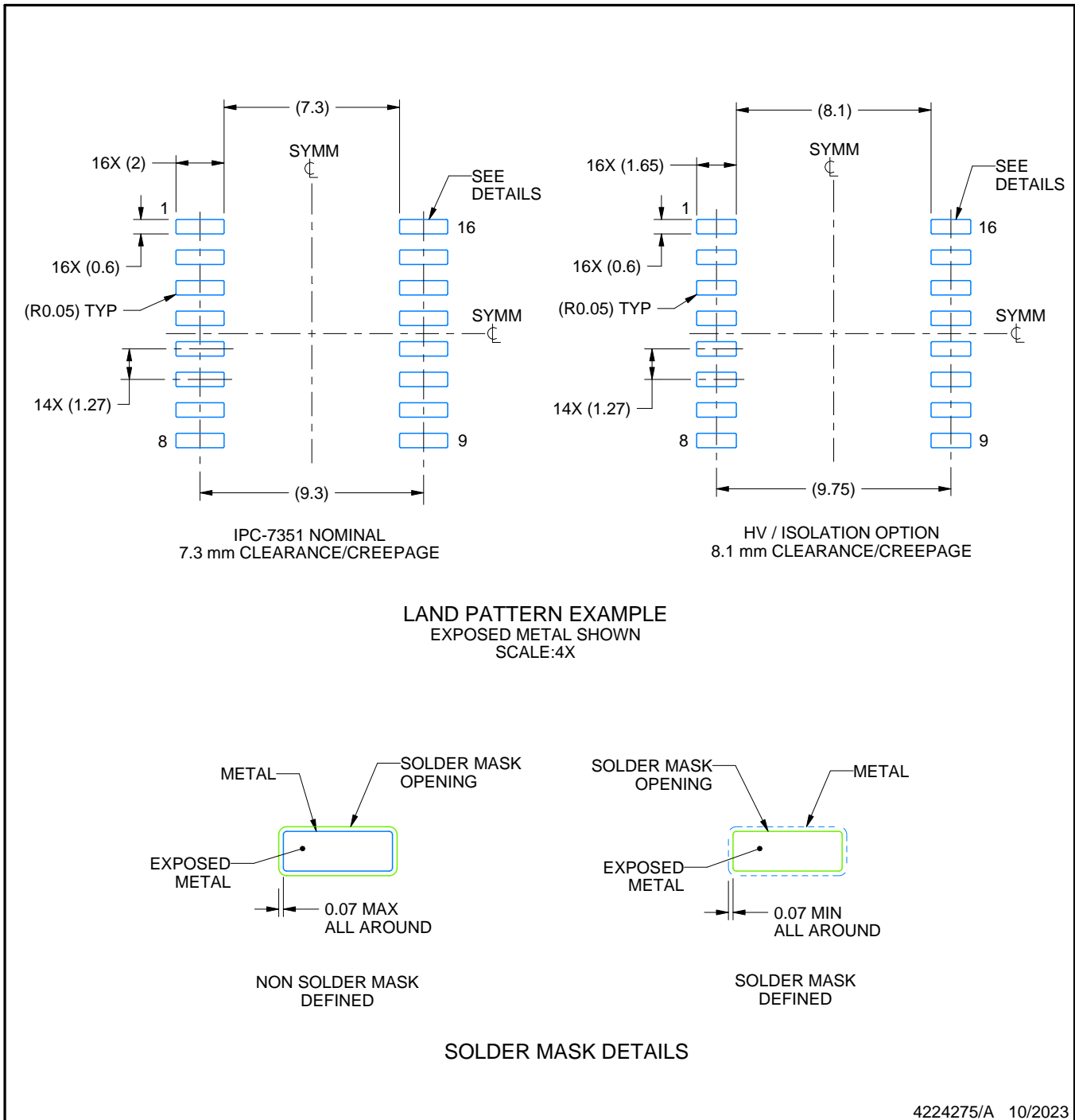

NOTES: (continued)

- 6. Publication IPC-7351 may have alternate designs.
- 7. Solder mask tolerances between and around signal pads can vary based on board fabrication site.

# EXAMPLE STENCIL DESIGN

DVE0016A

SO-MOD - 2.65 mm max height

SMALL OUTLINE INTEGRATED CIRCUIT

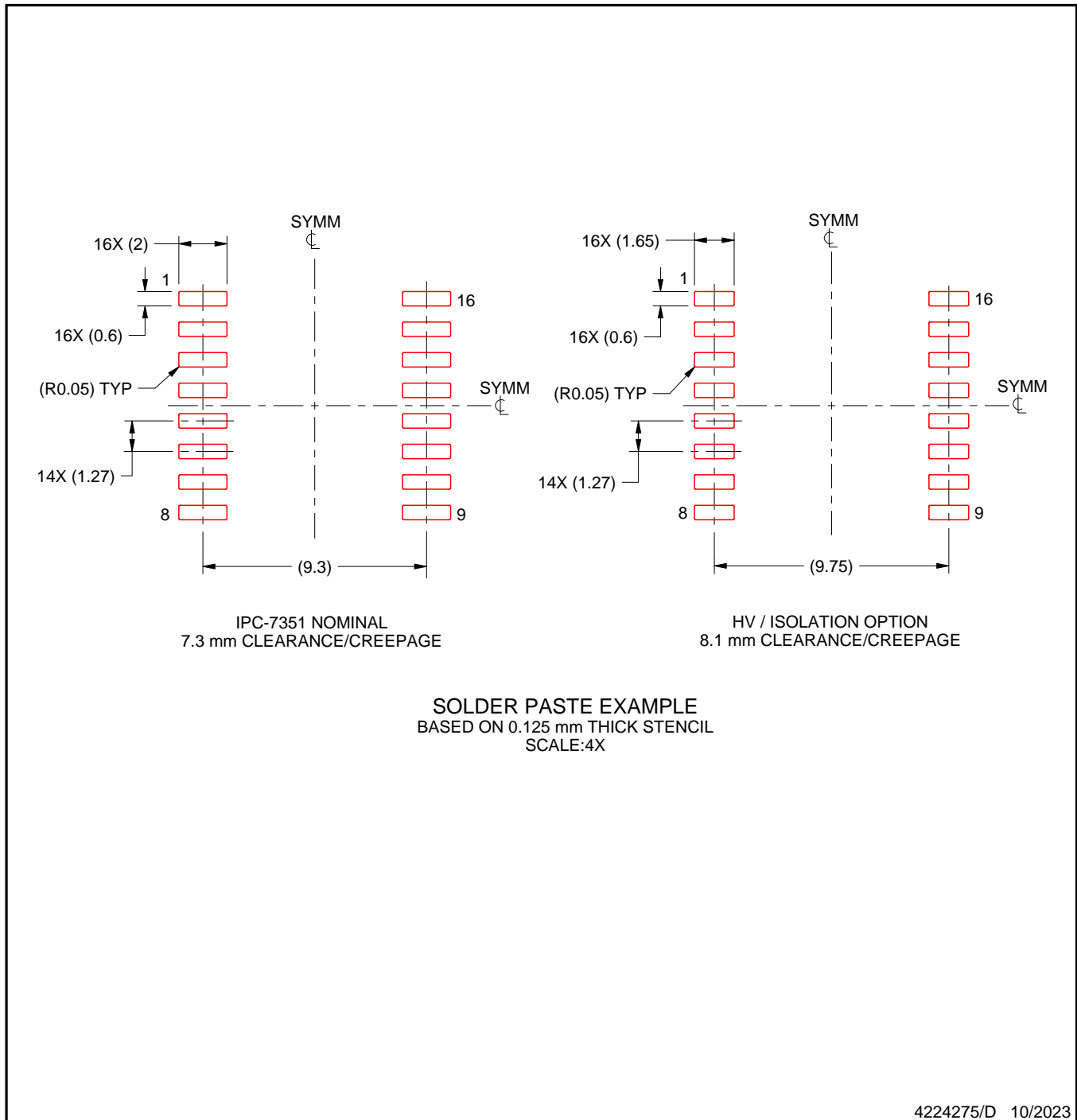

NOTES: (continued)

8. Laser cutting apertures with trapezoidal walls and rounded corners may offer better paste release. IPC-7525 may have alternate design recommendations.
9. Board assembly site may have different recommendations for stencil design.

## 重要なお知らせと免責事項

TI は、技術データと信頼性データ (データシートを含みます)、設計リソース (リファレンス・デザインを含みます)、アプリケーションや設計に関する各種アドバイス、Web ツール、安全性情報、その他のリソースを、欠陥が存在する可能性のある「現状のまま」提供しており、商品性および特定目的に対する適合性の黙示保証、第三者の知的財産権の非侵害保証を含むいかなる保証も、明示的または黙示的にかかわらず拒否します。

これらのリソースは、TI 製品を使用する設計の経験を積んだ開発者への提供を意図したものです。(1) お客様のアプリケーションに適した TI 製品の選定、(2) お客様のアプリケーションの設計、検証、試験、(3) お客様のアプリケーションに該当する各種規格や、その他のあらゆる安全性、セキュリティ、規制、または他の要件への確実な適合に関する責任を、お客様のみが単独で負うものとし、

上記の各種リソースは、予告なく変更される可能性があります。これらのリソースは、リソースで説明されている TI 製品を使用するアプリケーションの開発の目的でのみ、TI はその使用をお客様に許諾します。これらのリソースに関して、他の目的で複製することや掲載することは禁止されています。TI や第三者の知的財産権のライセンスが付与されている訳ではありません。お客様は、これらのリソースを自身で使用した結果発生するあらゆる申し立て、損害、費用、損失、責任について、TI およびその代理人を完全に補償するものとし、TI は一切の責任を拒否します。

TI の製品は、[TI の販売条件](#)、または [ti.com](https://www.ti.com) やかかる TI 製品の関連資料などのいずれかを通じて提供する適用可能な条項の下で提供されています。TI がこれらのリソースを提供することは、適用される TI の保証または他の保証の放棄の拡大や変更を意味するものではありません。

お客様がいかなる追加条項または代替条項を提案した場合でも、TI はそれらに異議を唱え、拒否します。

郵送先住所 : Texas Instruments, Post Office Box 655303, Dallas, Texas 75265  
Copyright © 2023, Texas Instruments Incorporated